

**Bressler Decl. In Support of
Apple's Opp. to Samsung's
Mot. For Summary
Judgment**

Ex. 66



US00D561156S

(12) **United States Design Patent**
Jung et al.

(10) **Patent No.:** **US D561,156 S**

(45) **Date of Patent:** **** Feb. 5, 2008**

(54) **PORTABLE TELEPHONE**

(75) Inventors: **Ha-Youl Jung**, Seoul (KR); **Nam-Mi Kim**, Seoul (KR); **Chang-Hwan Hwang**, Seoul (KR)

(73) Assignee: **Samsung Electronics Co., Ltd.**, Kyunggi-do (KR)

(**) Term: **14 Years**

(21) Appl. No.: **29/272,215**

(22) Filed: **Feb. 2, 2007**

(51) **LOC (8) Cl.** **14-03**

(52) **U.S. Cl.** **D14/138**

(58) **Field of Classification Search** D14/137,
D14/138, 147, 247, 496, 148, 248, 341-347;
455/475.4, 566, 575.1, 556.1, 556.2, 90.3;
379/433.01-433.13; 348/14.01, 14.02, 376;
D21/329, 331, 333

See application file for complete search history.

(56) **References Cited**

U.S. PATENT DOCUMENTS

D503,164 S	3/2005	Park et al.	
D503,699 S	4/2005	Lee et al.	
D508,240 S	8/2005	Lee et al.	
D511,342 S *	11/2005	Chien D14/346
D515,060 S	2/2006	Lee et al.	
D526,297 S	8/2006	Lee et al.	
D527,367 S	8/2006	Yun et al.	
D527,716 S	9/2006	Kim et al.	

D528,533 S	9/2006	Lee et al.	
D529,014 S	9/2006	Kim et al.	
D529,474 S	10/2006	Park et al.	
D529,891 S	10/2006	Hyun et al.	
D530,297 S	10/2006	Moon et al.	
D531,610 S	11/2006	Kim et al.	
D533,530 S	12/2006	Kim et al.	
D535,966 S	1/2007	Lee et al.	
D545,292 S *	6/2007	Lee et al. D14/138
D548,716 S *	8/2007	Park et al. D14/138

* cited by examiner

Primary Examiner—Terry A Wallace

(74) *Attorney, Agent, or Firm*—Flynn, Thiel, Boutell & Tanis, P.C.

(57) **CLAIM**

The ornamental design for a portable telephone, as shown and described.

DESCRIPTION

FIG. 1 is a top front perspective view of a portable telephone showing our new design;

FIG. 2 is a front elevational view thereof;

FIG. 3 is a rear elevational view thereof;

FIG. 4 is a left side elevational view thereof;

FIG. 5 is a right side elevational view thereof;

FIG. 6 is a top plan view thereof; and,

FIG. 7 is a bottom plan view thereof.

1 Claim, 4 Drawing Sheets

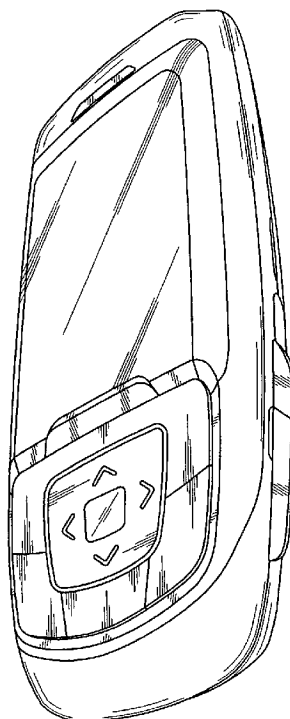

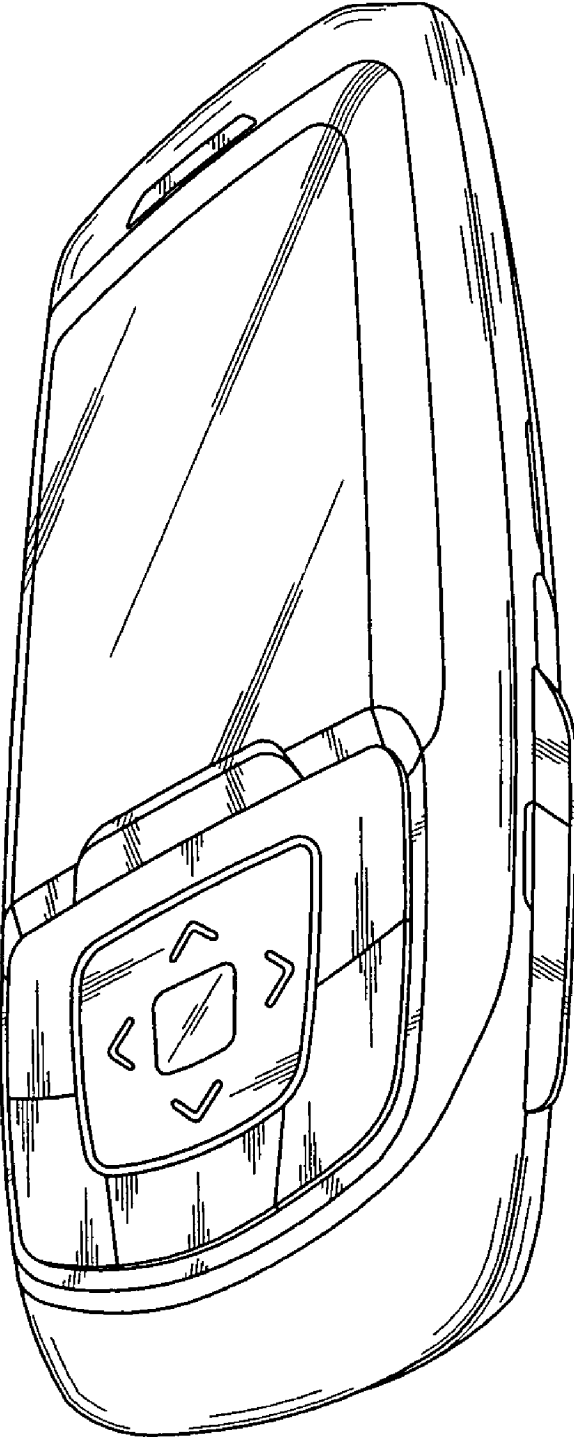

FIG. 1

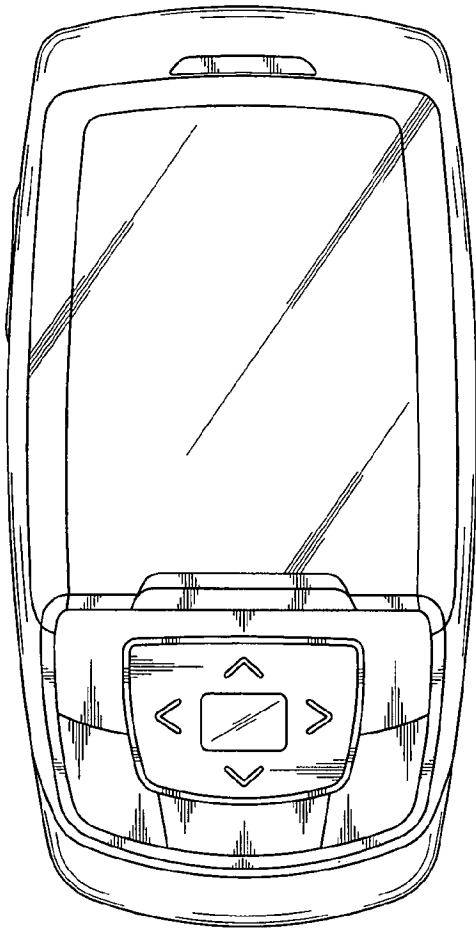

FIG. 2

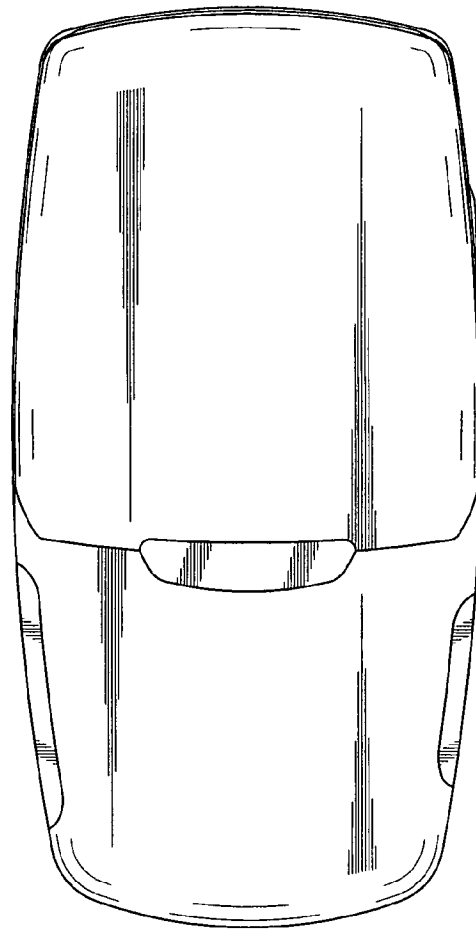

FIG. 3

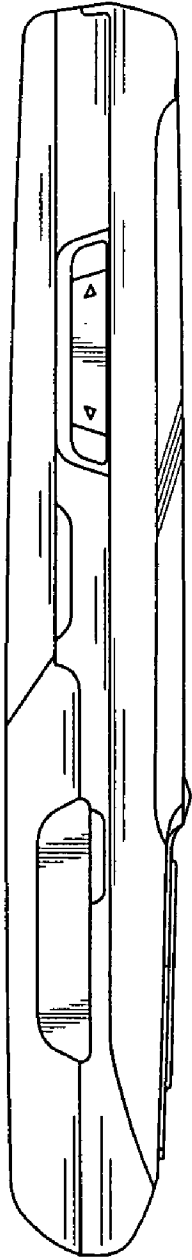

FIG. 4



FIG. 5

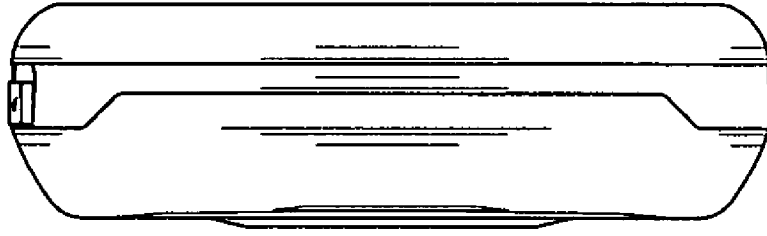

FIG. 6

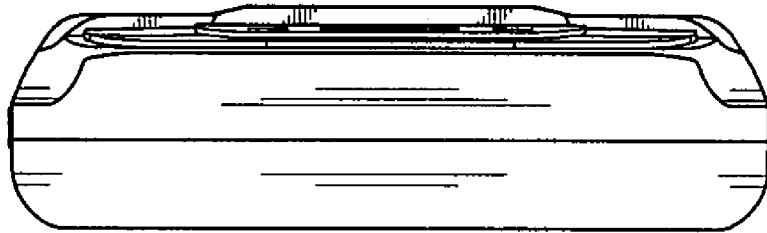

FIG. 7



US00D562794S

(12) **United States Design Patent**
Kim et al.

(10) **Patent No.:** **US D562,794 S**

(45) **Date of Patent:** **** Feb. 26, 2008**

(54) **MOBILE PHONE**

(75) Inventors: **Young-Soo Kim**, Goyang-si (KR);
Joon-Suh Kim, Anyang-si (KR);
Chang-Soo Lee, Incheon (KR)

(73) Assignee: **Samsung Electronics Co., Ltd.**,
Suwon-Si (KR)

(**) Term: **14 Years**

(21) Appl. No.: **29/273,169**

(22) Filed: **Feb. 28, 2007**

(30) **Foreign Application Priority Data**

Dec. 14, 2006 (KR) 30-2006-0049764

(51) **LOC (8) Cl.** **14-03**

(52) **U.S. Cl.** **D14/138**

(58) **Field of Classification Search** D14/137,
D14/138, 147, 218, 247–248, 341–347, 496;
455/90.3, 556.1, 556.2, 575.1, 575.3, 575.4;
379/433.01–433.13; 361/814; 348/14.02

See application file for complete search history.

(56) **References Cited**

U.S. PATENT DOCUMENTS

D489,052	S	*	4/2004	Shiraki et al.	D14/156
D499,424	S	*	12/2004	Bahroocha	D14/496
D526,300	S	*	8/2006	Lee	D14/138
D528,528	S	*	9/2006	Moon et al.	D14/138
D529,465	S	*	10/2006	Kim et al.	D14/138
D529,471	S	*	10/2006	Park	D14/138
D529,890	S	*	10/2006	Park et al.	D14/138
D534,143	S	*	12/2006	Lheem	D14/138
D534,145	S	*	12/2006	Lheem	D14/138
D534,517	S	*	1/2007	Cho et al.	D14/138
D534,888	S	*	1/2007	Kim et al.	D14/138
D534,890	S	*	1/2007	Kim	D14/138
D534,891	S	*	1/2007	Park et al.	D14/138
D535,274	S	*	1/2007	Lee	D14/138
D535,637	S	*	1/2007	Park et al.	D14/138
D536,690	S	*	2/2007	Lee	D14/138
D537,062	S	*	2/2007	Kim et al.	D14/138
D539,814	S	*	4/2007	Andre et al.	D14/496
D541,785	S	*	5/2007	Hwang et al.	D14/138
D546,313	S	*	7/2007	Lheem	D14/138
D546,809	S	*	7/2007	Kim et al.	D14/138
2004/0242288	A1	*	12/2004	Balle et al.	455/575.1

2005/0014538	A1	*	1/2005	Hyun et al.	455/575.4
2007/0037618	A1	*	2/2007	Lee	455/575.4
2007/0123179	A1	*	5/2007	Lim	455/90.3
2007/0142101	A1	*	6/2007	Seshagiri et al.	455/575.4

OTHER PUBLICATIONS

Gigabyte g-YoYo, announced 2006, [online], [retrieved on Feb. 20, 2007]. Retrieved from Internet ,<URL: http://www.gsmarena.com>.*

LG M6100, announced Jan. 2006, [online], [retrieved on Feb. 20, 2007]. Retrieved from Internet ,<URL: http://www.gsmarena.com>.*

Sony Ericsson S500, announced May 2007, [online], [retrieved on May 18, 2007]. Retrieved from Internet ,<URL: http://www.gsmarena.com>.*

* cited by examiner

Primary Examiner—Jeffrey Asch

Assistant Examiner—Bridget L Eland

(74) *Attorney, Agent, or Firm*—Staas & Halsey LLP

(57) **CLAIM**

The ornamental design for a mobile phone, as shown and described.

DESCRIPTION

FIG. 1 is a perspective view of a mobile phone;
FIG. 2 is a front view of the mobile phone of FIG. 1;
FIG. 3 is a rear view of the mobile phone of FIG. 1;
FIG. 4 is a left-side view of the mobile phone of FIG. 1;
FIG. 5 is a right-side view of the mobile phone of FIG. 1;
FIG. 6 is a top plan view of the mobile phone of FIG. 1;
FIG. 7 is a bottom plan view of the mobile phone of FIG. 1;
FIG. 8 is a perspective view of the mobile phone of FIG. 1 displaying its capacity to attach a laser pointer; and,
FIG. 9 is a perspective view of the mobile phone of FIG. 1 with an attached speaker.

The broken line showing of accessory components are for illustrative purposes only and form no part of the claimed design.

1 Claim, 6 Drawing Sheets

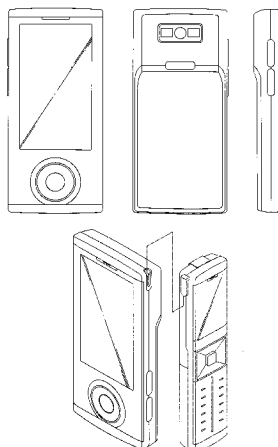

FIG. 1

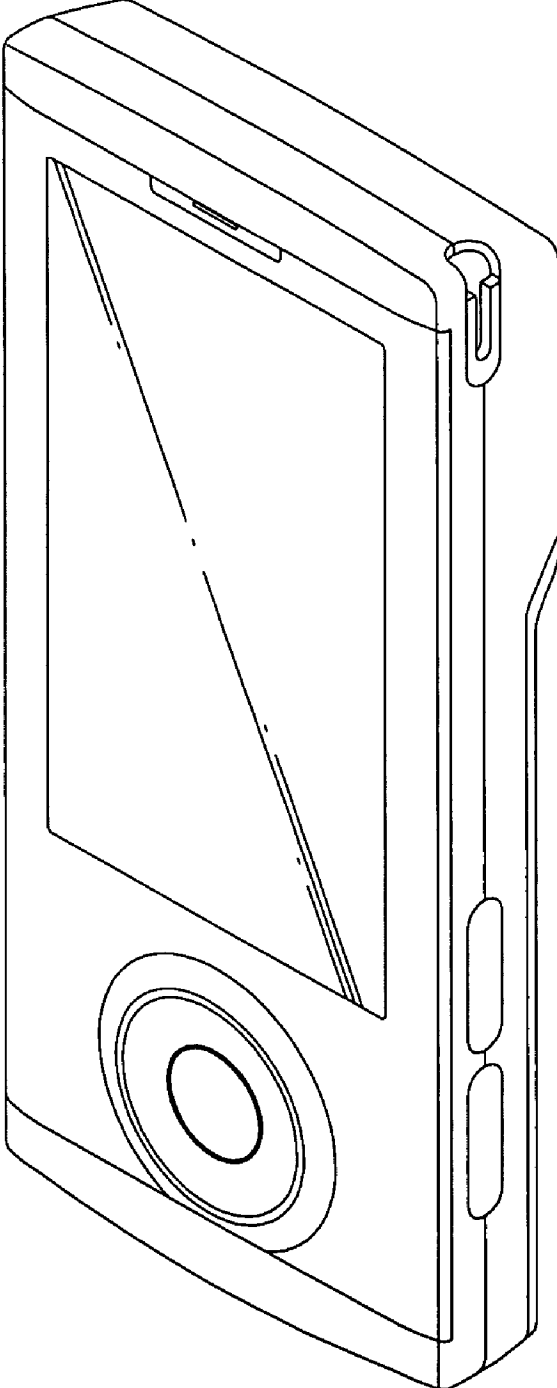

FIG. 2

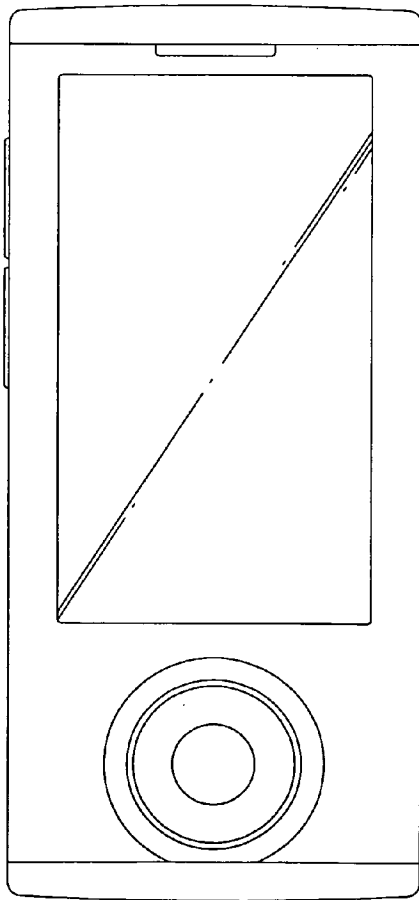

FIG. 3

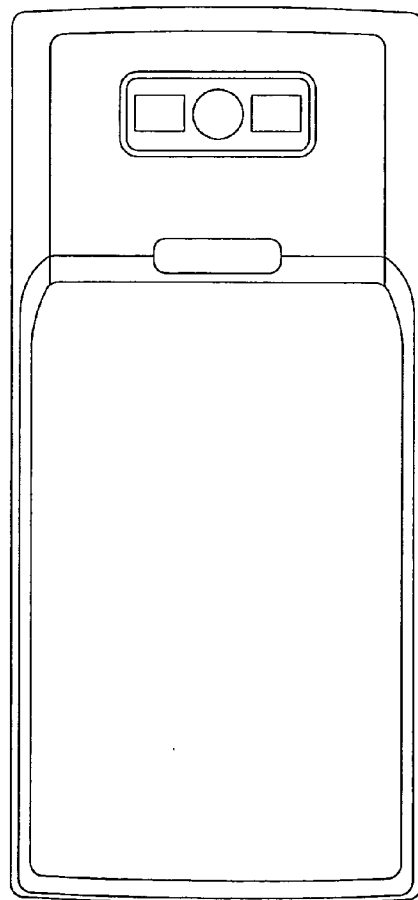

FIG. 4

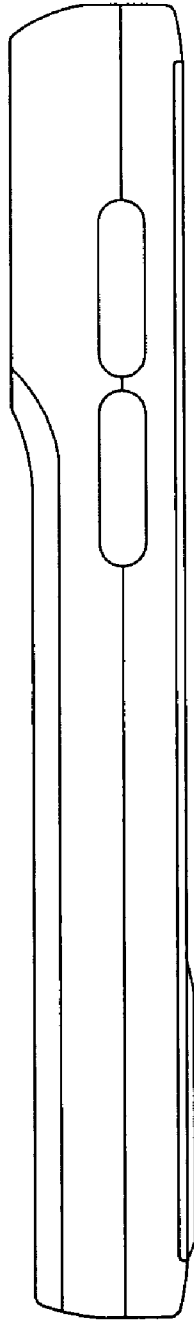

FIG. 5

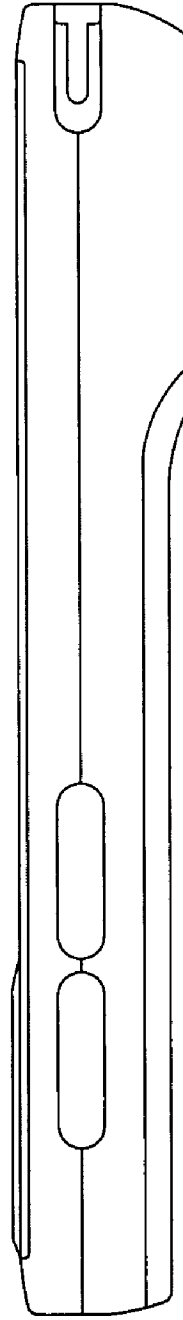

FIG. 6



FIG. 7

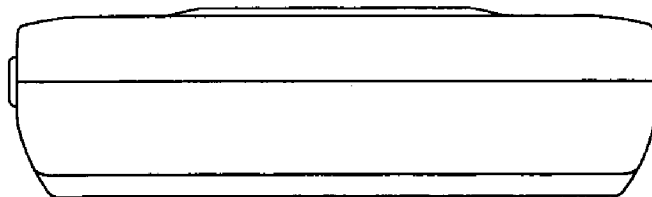

FIG. 8

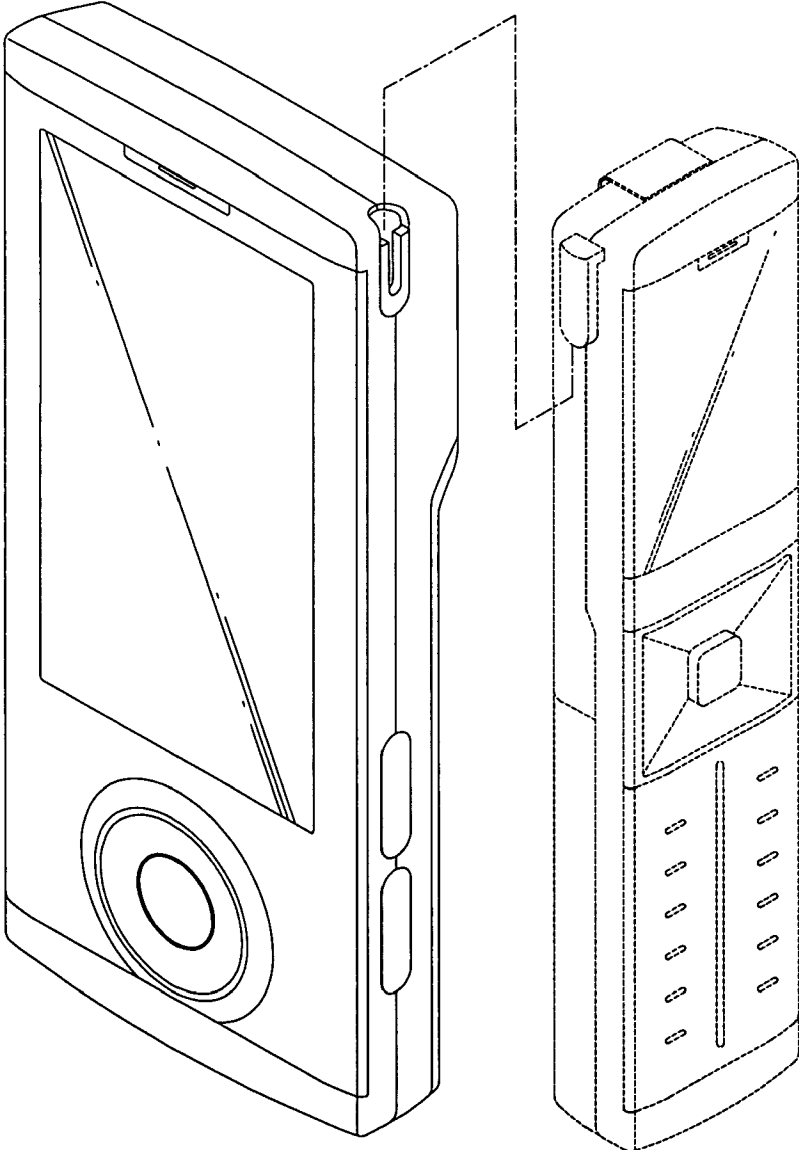
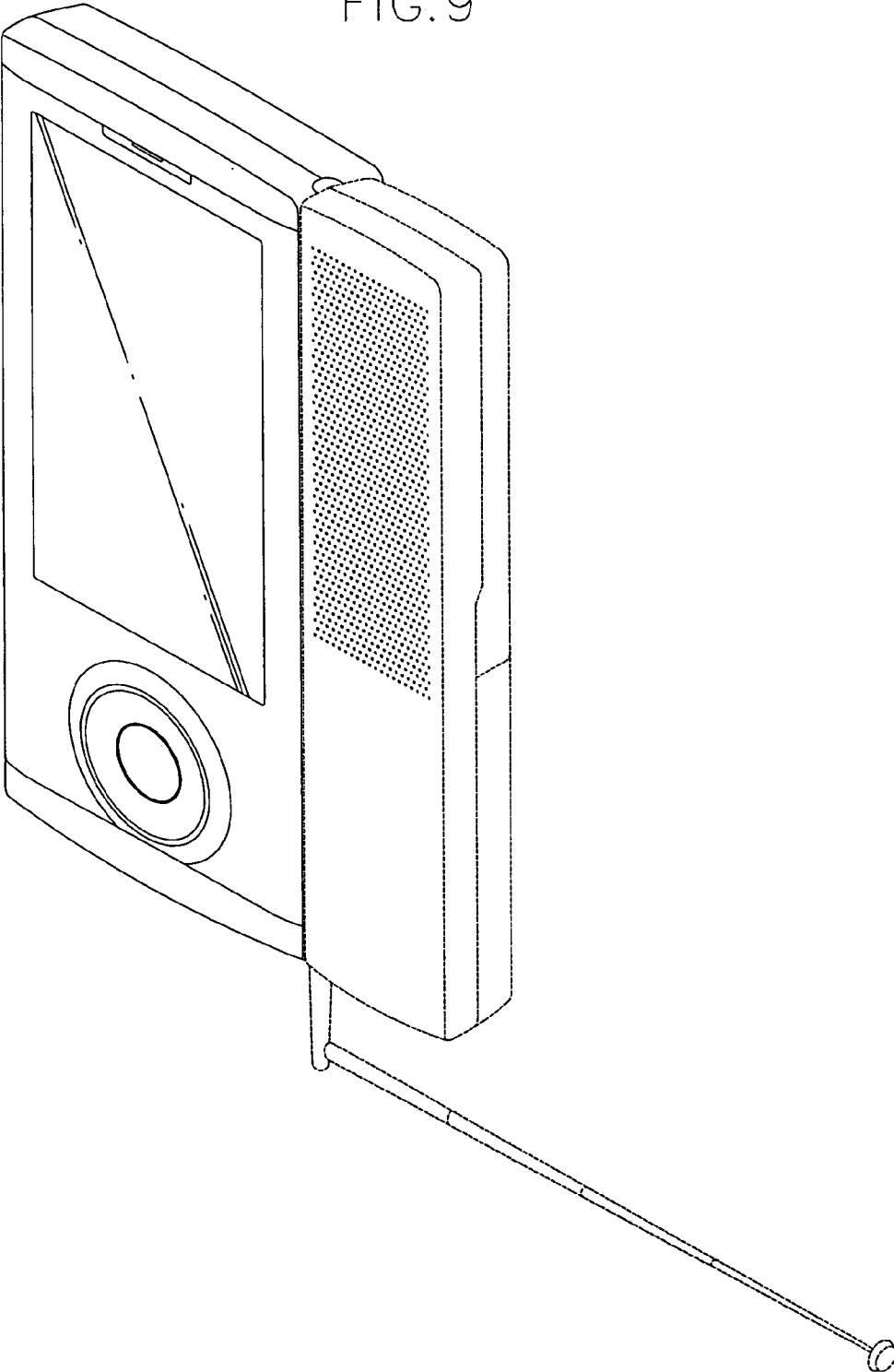

FIG. 9





US00D616856S

(12) **United States Design Patent**
Song et al.

(10) **Patent No.:** **US D616,856 S**

(45) **Date of Patent:** **** Jun. 1, 2010**

(54) **MOBILE PHONE**

(75) Inventors: **Bong-Kyu Song**, Seoul (KR);
Young-Keun Lee, Seoul (KR);
Chang-Hwan Hwang, Goyang-Si (KR)

(73) Assignee: **Samsung Electronics Co., Ltd.**,
Suwon-Si (KR)

(**) Term: **14 Years**

(21) Appl. No.: **29/340,829**

(22) Filed: **Jul. 27, 2009**

(30) **Foreign Application Priority Data**

Jun. 11, 2009 (KR) 30-2009-0025682

(51) **LOC (9) Cl.** **14-03**

(52) **U.S. Cl.** **D14/138 AD**

(58) **Field of Classification Search** D14/138 R,
D14/138 AD, 138 AC, 138 C, 138 G, 191,
D14/203.1-203.8, 496, 138 AA, 138 AB,
D14/247-248, 137, 147, 218, 341-347; D10/65,
D10/78, 104; D13/168; D18/7; 455/566,
455/575.1, 575.3

See application file for complete search history.

(56) **References Cited**

U.S. PATENT DOCUMENTS

D488,471 S * 4/2004 Yagawa et al. D14/346
D529,474 S * 10/2006 Park et al. D14/138 AD
D531,977 S * 11/2006 Kim et al. D14/138 AD
D547,292 S * 7/2007 Kim et al. D14/138 AC
D548,214 S * 8/2007 Kim et al. D14/138 AD
D548,713 S * 8/2007 Lee et al. D14/138 AD
D549,202 S * 8/2007 Kim et al. D14/138 AB
D553,596 S * 10/2007 Kim et al. D14/138 AD
D554,098 S * 10/2007 Lee D14/138 AD
D556,165 S * 11/2007 Kim et al. D14/138 G
D557,236 S * 12/2007 Hideki et al. D14/138 AD
D558,619 S * 1/2008 Bloem D10/65
D558,713 S * 1/2008 Kim et al. D14/138 AD
D560,193 S * 1/2008 Sung et al. D14/138 AD

D563,936 S * 3/2008 Kim et al. D14/138 AD
D583,789 S * 12/2008 Chambers D14/138 AD
D599,318 S * 9/2009 Kim et al. D14/138 AD
D601,107 S * 9/2009 Kim et al. D14/138 AD
D601,993 S * 10/2009 Yun et al. D14/138 AD
D602,460 S * 10/2009 Kim et al. D14/138 AD
D602,461 S * 10/2009 Kim et al. D14/138 AD
2006/0094464 A1 * 5/2006 Kyou et al. 455/556.1

(Continued)

OTHER PUBLICATIONS

Eten glofish M700, announced Nov. 2006, [online], [retrieved on Feb. 20, 2007]. Retrieved from Internet ,<URL: http://www.gsmarena.com>.*

(Continued)

Primary Examiner—Jeffrey D Asch
Assistant Examiner—Bridget L Eland
(74) *Attorney, Agent, or Firm*—Staas & Halsey LLP

(57) **CLAIM**

The ornamental design for mobile phone, as shown and described.

DESCRIPTION

FIG. 1 is a front perspective view of a mobile phone;
FIG. 2 is a front view of the mobile phone of FIG. 1;
FIG. 3 is a rear view of the mobile phone of FIG. 1;
FIG. 4 is a left-side view of the mobile phone of FIG. 1;
FIG. 5 is a right-side view of the mobile phone of FIG. 1;
FIG. 6 is a top plan view of the mobile phone of FIG. 1; and,
FIG. 7 is a bottom plan view of the mobile phone of FIG. 1.

1 Claim, 5 Drawing Sheets

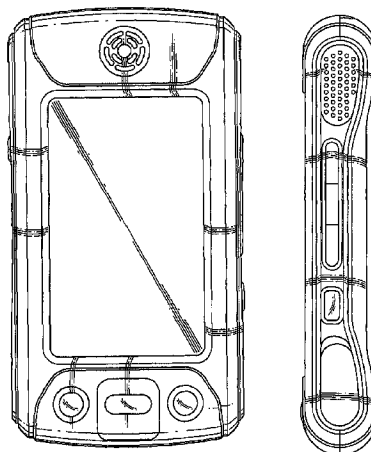

US D616,856 S

Page 2

U.S. PATENT DOCUMENTS

2006/0166713 A1* 7/2006 Yeh et al. 455/575.1
2006/0205450 A1* 9/2006 Amano et al. 455/575.4
2006/0211460 A1* 9/2006 Jeong et al. 455/575.4
2008/0076480 A1* 3/2008 Jeong et al. 455/566

OTHER PUBLICATIONS

Eten glofiish DX900, announced Jun. 2008, [online], [retrieved on Jun. 13, 2008]. Retrieved from Internet ,<URL: <http://www.gsmarena.com>>.*

HTC TyTN, announced Jun. 2006, [online], [retrieved on Feb. 20, 2007]. Retrieved from Internet ,<URL: <http://www.gsmarena.com>>.*

NEC N940, announced 4th quarter 2004, [online], [retrieved on Feb. 20, 2007]. Retrieved from Internet ,<URL: <http://www.gsmarena.com>>.*

* cited by examiner

FIG. 1

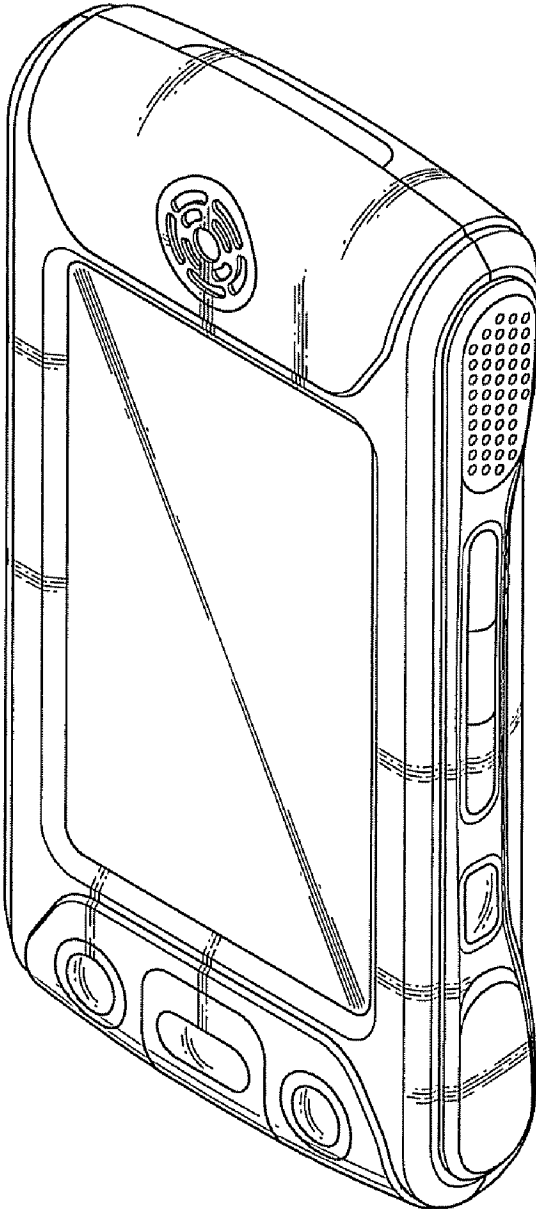

FIG. 2

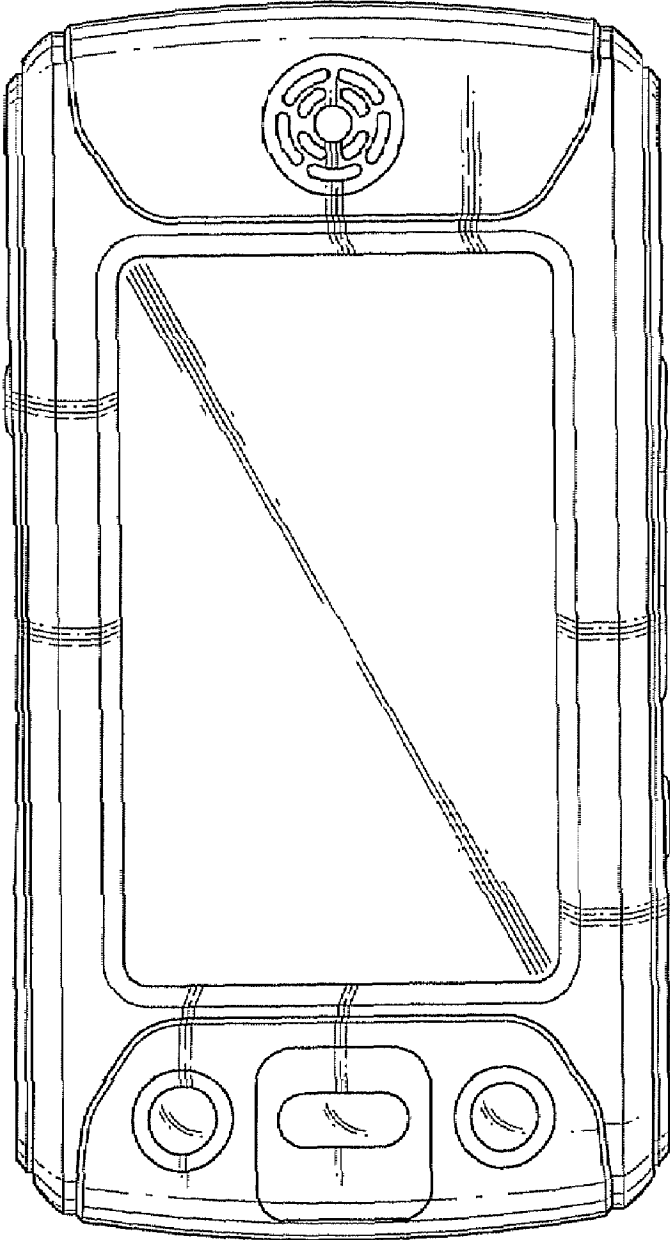

FIG. 3

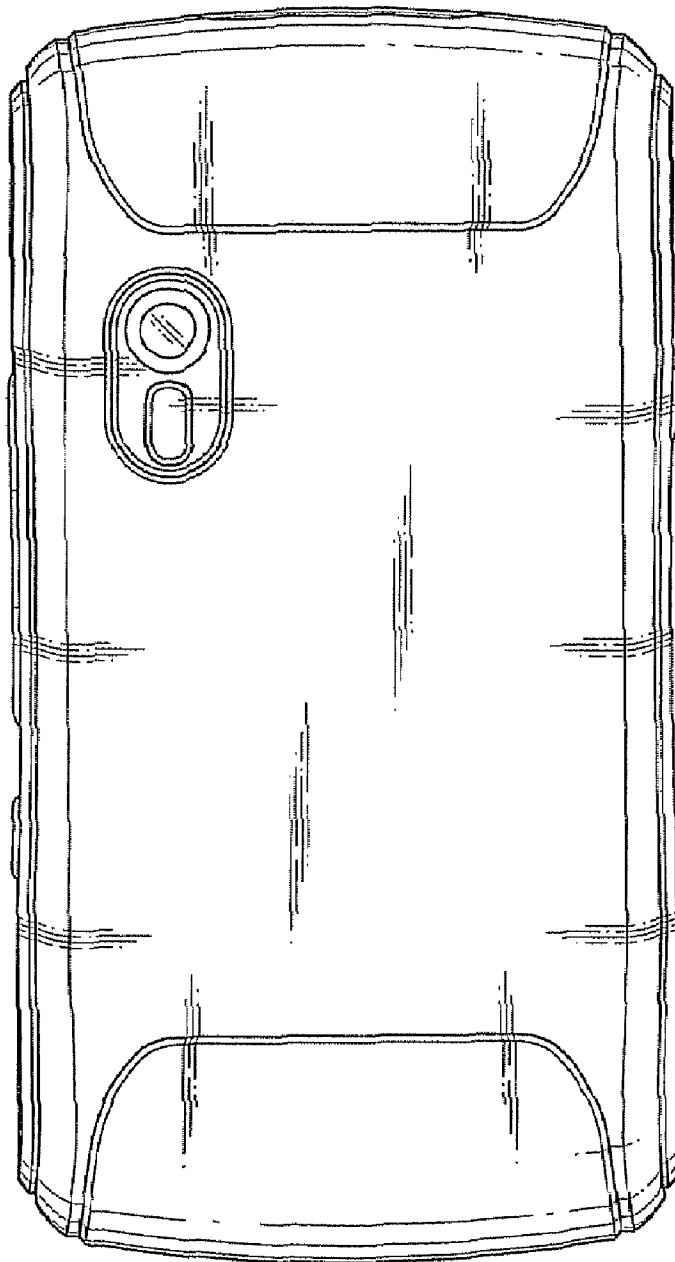

FIG. 4

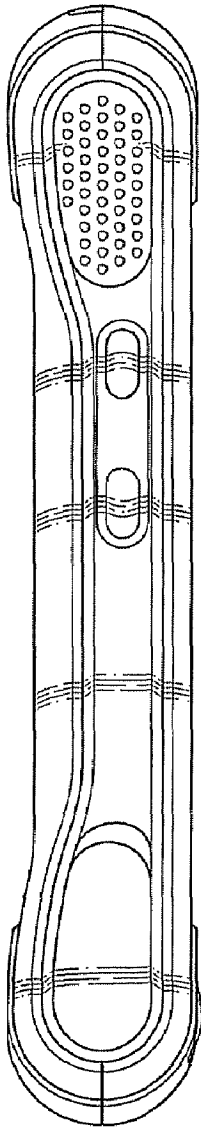

FIG. 5

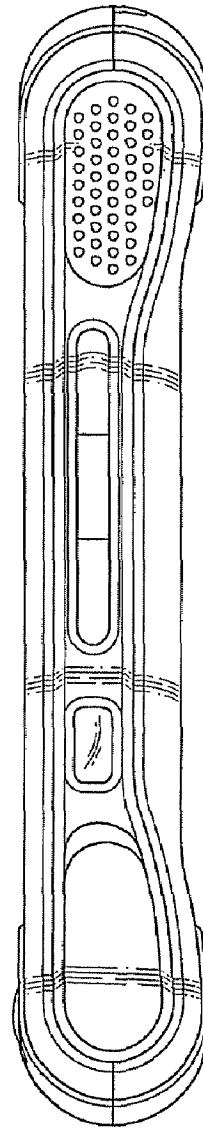

FIG. 6

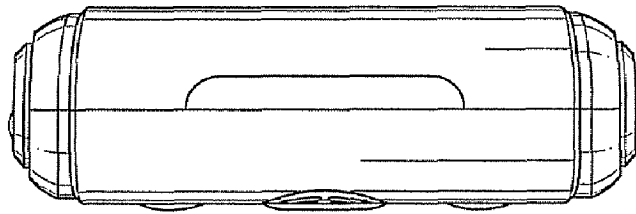
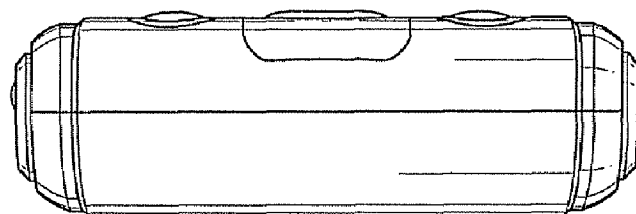

FIG. 7





US00D616857S

(12) **United States Design Patent**
Kim et al.

(10) **Patent No.:** **US D616,857 S**

(45) **Date of Patent:** **** Jun. 1, 2010**

(54) **MOBILE PHONE**

(75) Inventors: **Tae-Ho Kim**, Yongin-Si (KR);
Young-Keun Lee, Seoul (KR);
Chang-Hwan Hwang, Goyang-Si (KR)

(73) Assignee: **Samsung Electronics Co., Ltd.**,
Suwon-Si (KR)

(**) Term: **14 Years**

(21) Appl. No.: **29/340,832**

(22) Filed: **Jul. 27, 2009**

(30) **Foreign Application Priority Data**

Jun. 11, 2009 (KR) 30-2009-0025684

(51) **LOC (9) Cl.** **14-03**

(52) **U.S. Cl.** **D14/138 AD**

(58) **Field of Classification Search** D14/138 R,
D14/138 AD, 138 AC, 138 C, 138 G, 191,
D14/203.1-203.8, 496, 138 AA, 138 AB,
D14/247-248, 137, 147, 218, 341-347; D10/65,
D10/78, 104; D13/168; D18/7; 455/566,
455/575.1, 575.3

See application file for complete search history.

(56) **References Cited**

U.S. PATENT DOCUMENTS

D451,079 S * 11/2001 Ali D14/138 AA
D454,849 S * 3/2002 Eckholm D14/138 AA
D457,883 S * 5/2002 Sugioka et al. D14/342
D461,185 S * 8/2002 Ando D14/341
D476,328 S * 6/2003 Miao et al. D14/346
D478,075 S * 8/2003 Hayes D14/343
D479,215 S * 9/2003 Yokoyama D14/138 AD
D481,692 S * 11/2003 Husgafvel D14/138 AD
D497,161 S * 10/2004 Chien D14/346
D509,203 S * 9/2005 Bertrand et al. D14/138 AD
D509,204 S * 9/2005 Michler D14/138 AD
D509,497 S * 9/2005 Michler D14/138 AD
D553,596 S * 10/2007 Kim et al. D14/138 AD

D555,137 S * 11/2007 Kim et al. D14/138 AD
D555,138 S * 11/2007 Park et al. D14/138 AD
D558,177 S * 12/2007 Han et al. D14/138 AD
D558,718 S * 1/2008 Park et al. D14/138 AD
D573,129 S * 7/2008 Park et al. D14/138 AD
D575,762 S * 8/2008 Ou D14/138 G

(Continued)

OTHER PUBLICATIONS

BenQ U700, announced 1st quarter 2005, [online], [retrieved on Feb. 20, 2007]. Retrieved from Internet ,<URL: <http://www.gsmarena.com>>.*

(Continued)

Primary Examiner—Jeffrey D Asch
Assistant Examiner—Bridget L Eland
(74) *Attorney, Agent, or Firm*—Staas & Halsey LLP

(57) **CLAIM**

The ornamental design for mobile phone, as shown and described.

DESCRIPTION

FIG. 1 is a front perspective view of a mobile phone;
FIG. 2 is a front view of the mobile phone of FIG. 1;
FIG. 3 is a rear view of the mobile phone of FIG. 1;
FIG. 4 is a left-side view of the mobile phone of FIG. 1;
FIG. 5 is a right-side view of the mobile phone of FIG. 1;
FIG. 6 is a top plan view of the mobile phone of FIG. 1; and
FIG. 7 is a bottom plan view of the mobile phone of FIG. 1.

1 Claim, 7 Drawing Sheets

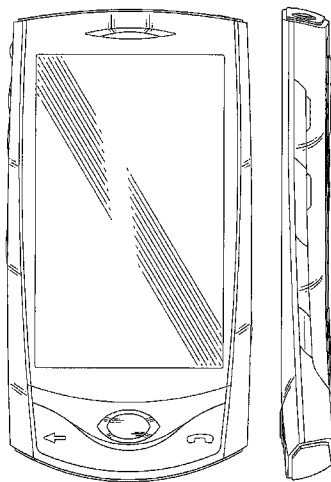

US D616,857 S

Page 2

U.S. PATENT DOCUMENTS

D584,273 S * 1/2009 Hong et al. D14/138 G
D590,802 S * 4/2009 Shin et al. D14/138 AD
D598,880 S * 8/2009 Su D14/138 G
D602,464 S * 10/2009 Chung et al. D14/138 AD
2006/0063548 A1 * 3/2006 Kim 455/518
2009/0149217 A1 * 6/2009 Adishesann et al. 455/556.2
2009/0239593 A1 * 9/2009 Jayasinghe et al. 455/575.1

OTHER PUBLICATIONS

HTC P6500, announced Oct. 2007, [online], [retrieved on Dec. 13, 2007]. Retrieved from Internet ,<URL: <http://www.gsmarena.com>>.*

i-mate K-JAM, announced Sep. 2005, [online], [retrieved on Feb. 20, 2007]. Retrieved from Internet ,<URL: <http://www.gsmarena.com>>.*

O2 XDA mini S, announced 3rd quarter 2005, [online], [retrieved on Feb. 20, 2007]. Retrieved from Internet ,<URL: <http://www.gsmarena.com>>.*

Qtek 9100, announced 3rd quarter 2005, [online], [retrieved on Feb. 20, 2007]. Retrieved from Internet ,<URL: <http://www.gsmarena.com>>.*

* cited by examiner

FIG. 1

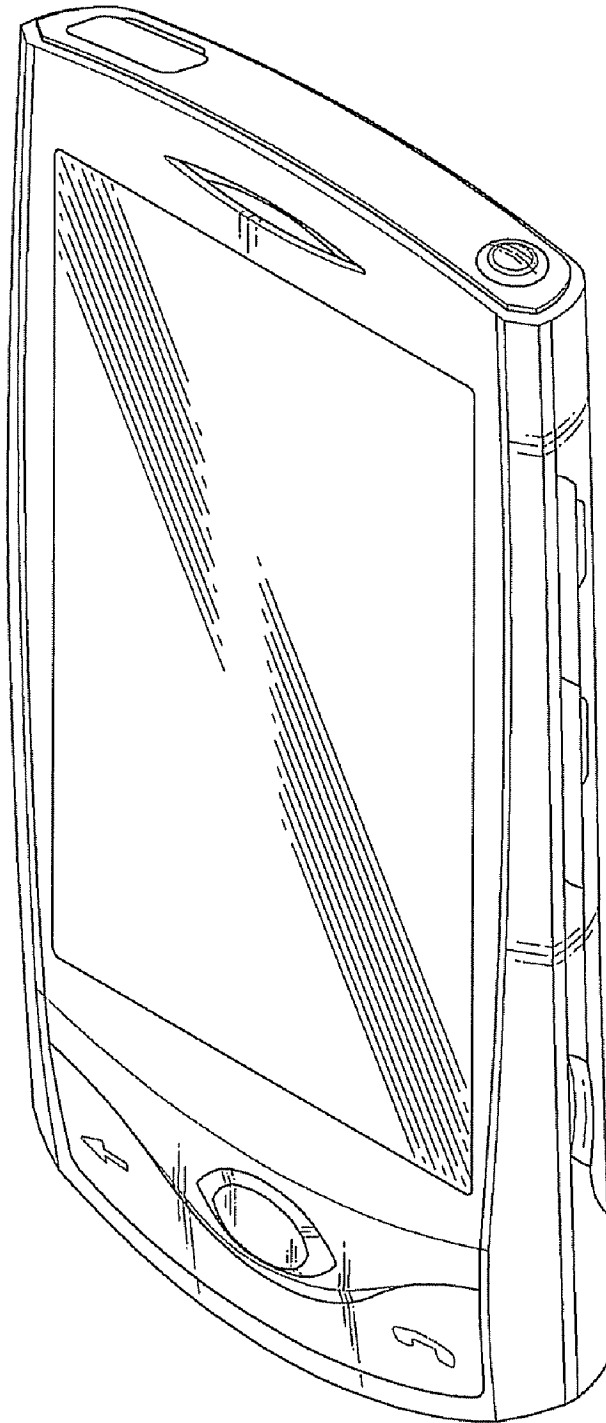

FIG. 2

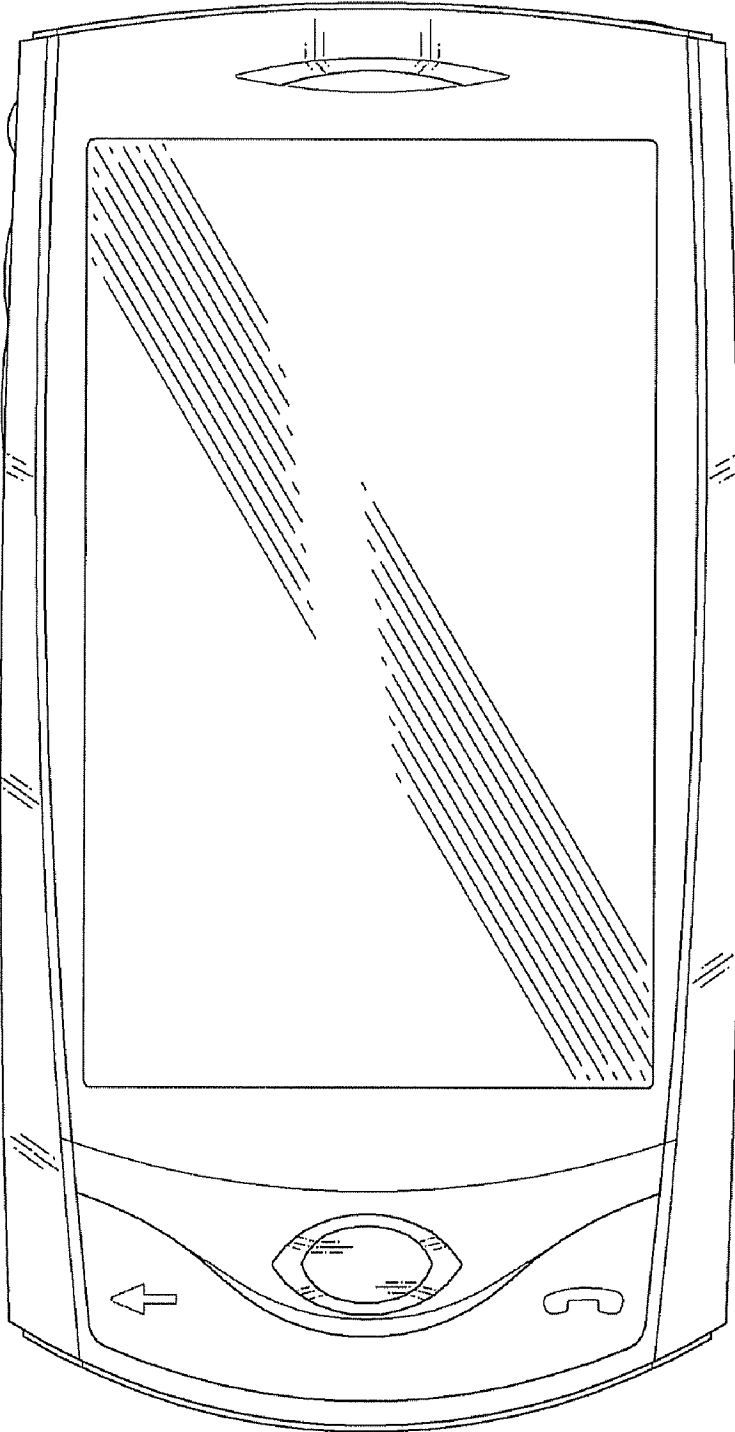

FIG. 3

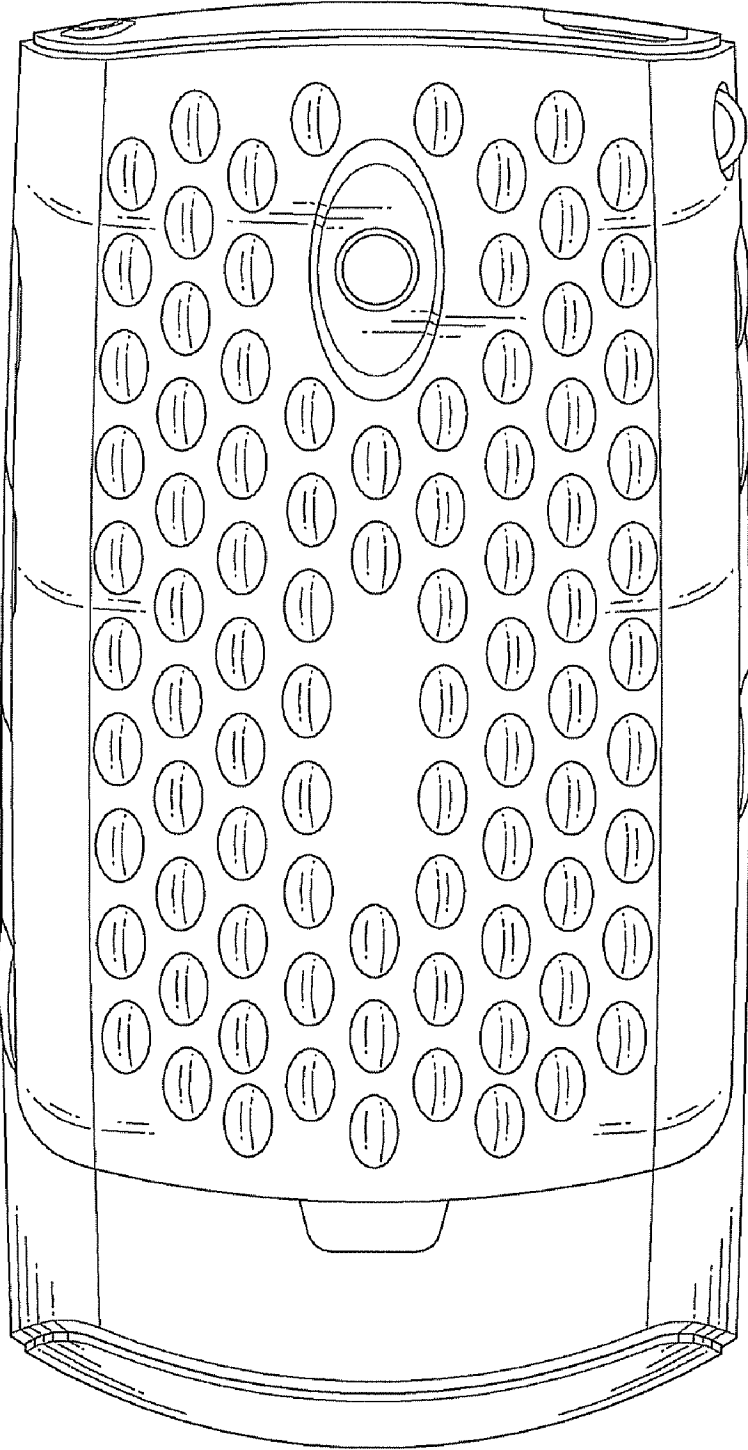

FIG. 4

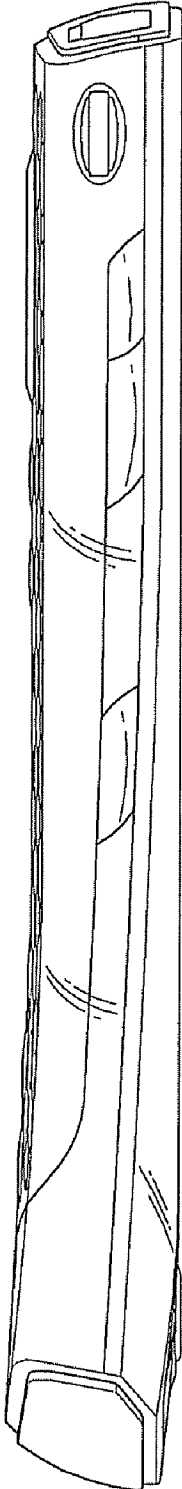

FIG. 5

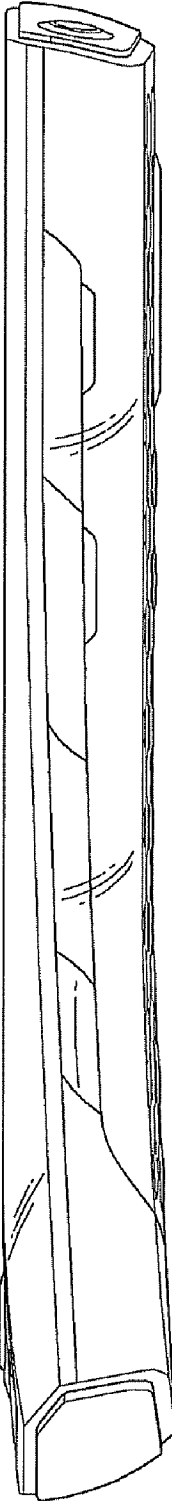

FIG. 6

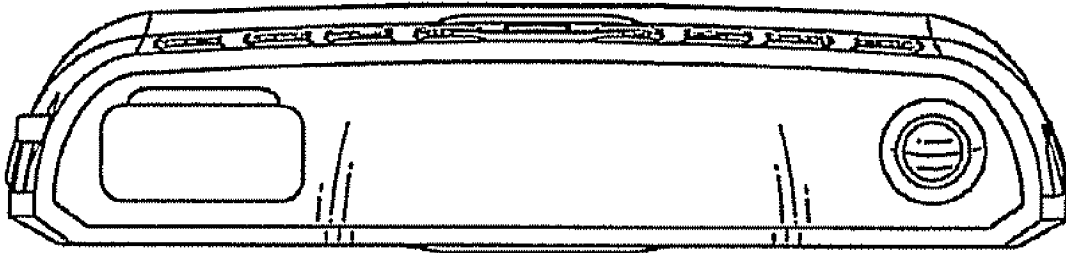
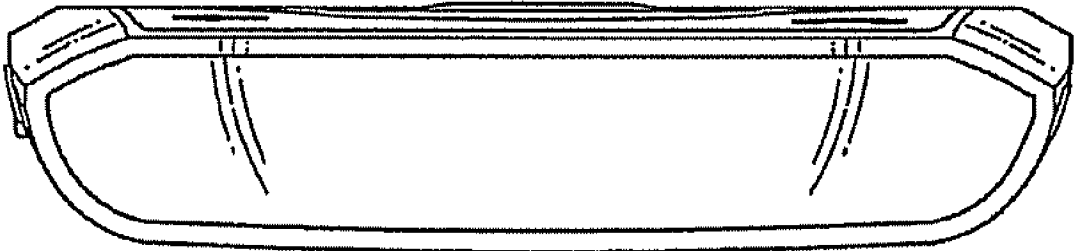

FIG. 7





US00D624046S

(12) **United States Design Patent**
Lee et al.

(10) **Patent No.:** **US D624,046 S**

(45) **Date of Patent:** **** Sep. 21, 2010**

(54) **CELLULAR PHONE**

(75) Inventors: **Hye-Jeong Lee**, Seoul (KR);
Chang-Hwan Hwang, Seongnam-si
(KR); **Beom-Ku Han**, Seoul (KR);
Nam-Mi Kim, Seoul (KR); **Min-Ah
Koh**, Seoul (KR); **Ji-Hye Youn**,
Seongnam-si (KR)

(73) Assignee: **Samsung Electronics Co., Ltd.**,
Suwon-si, Gyeonggi-do (KR)

(**) Term: **14 Years**

(21) Appl. No.: **29/356,905**

(22) Filed: **Mar. 4, 2010**

(51) **LOC (9) Cl.** **14-03**

(52) **U.S. Cl.** **D14/138 G**

(58) **Field of Classification Search** D14/138 R,
D14/138 AD, 138 AC, 138 C, 138 G, 191,
D14/203.1–203.8, 496, 138 AA, 138 AB,
D14/247–248, 137, 147, 218, 341–347; D10/65,
D10/78, 104; D13/168; D18/7; 455/566,
455/575.1, 575.3

See application file for complete search history.

(56) **References Cited**

U.S. PATENT DOCUMENTS

D343,366	S *	1/1994	Dreher	D10/104
D457,883	S *	5/2002	Sugioka et al.	D14/342
D509,814	S *	9/2005	Shin et al.	D14/138 AC
D519,998	S *	5/2006	Park	D14/346
D525,225	S *	7/2006	Lee	D14/138 AD
D527,369	S *	8/2006	Chung et al.	D14/138 AD
D554,097	S *	10/2007	Lee	D14/138 AD
D555,138	S *	11/2007	Park et al.	D14/138 AD
D555,616	S *	11/2007	Lin	D14/138 AD
D555,618	S *	11/2007	Mursalie et al.	D14/138 AD
D556,168	S *	11/2007	Kim et al.	D14/138 AD
D562,295	S *	2/2008	Lindner et al.	D14/138 AB
D575,762	S *	8/2008	Ou	D14/138 G

D589,505	S *	3/2009	He	D14/248
D590,802	S *	4/2009	Shin et al.	D14/138 AD
D591,740	S *	5/2009	Luke et al.	D14/341
D603,356	S *	11/2009	Sterzick et al.	D14/138 G
D605,156	S *	12/2009	Kim et al.	D14/138 AB
D605,621	S *	12/2009	Kim et al.	D14/138 AD
D608,752	S *	1/2010	He	D14/138 AA
D615,945	S *	5/2010	Kim et al.	D14/138 G
D616,857	S *	6/2010	Kim et al.	D14/138 AD
D619,557	S *	7/2010	Han et al.	D14/138 AD
D619,988	S *	7/2010	Ji et al.	D14/138 G
2002/0187818	A1 *	12/2002	Kang	455/575
2010/0022277	A1 *	1/2010	An et al.	455/566

OTHER PUBLICATIONS

Samsung I5700 Galaxy Spica, announced Sep. 2009, [online], [retrieved on Oct. 28, 2009]. Retrieved from Internet ,<URL: http://www.gsmarena.com>.*

Samsung S8500 Wave, announced Feb. 2010, [online], [retrieved on Feb. 17, 2010]. Retrieved from Internet ,<URL: http://www.gsmarena.com>.*

* cited by examiner

Primary Examiner—Bridget L Eland

(74) *Attorney, Agent, or Firm*—Lexyoume IP Group, PLLC.

(57) **CLAIM**

The ornamental design for a cellular phone, as shown and described.

DESCRIPTION

FIG. 1 is a perspective view of a cellular phone showing our new design;

FIG. 2 is a front elevational view thereof;

FIG. 3 is a rear elevational view thereof;

FIG. 4 is a left side elevational view thereof;

FIG. 5 is a right side elevational view thereof;

FIG. 6 is a top plan view thereof; and,

FIG. 7 is a bottom plan view thereof.

1 Claim, 6 Drawing Sheets

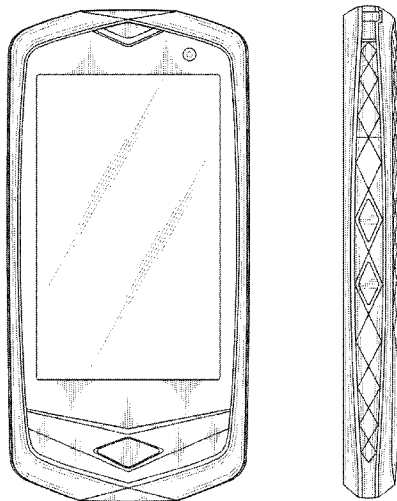

FIG. 1

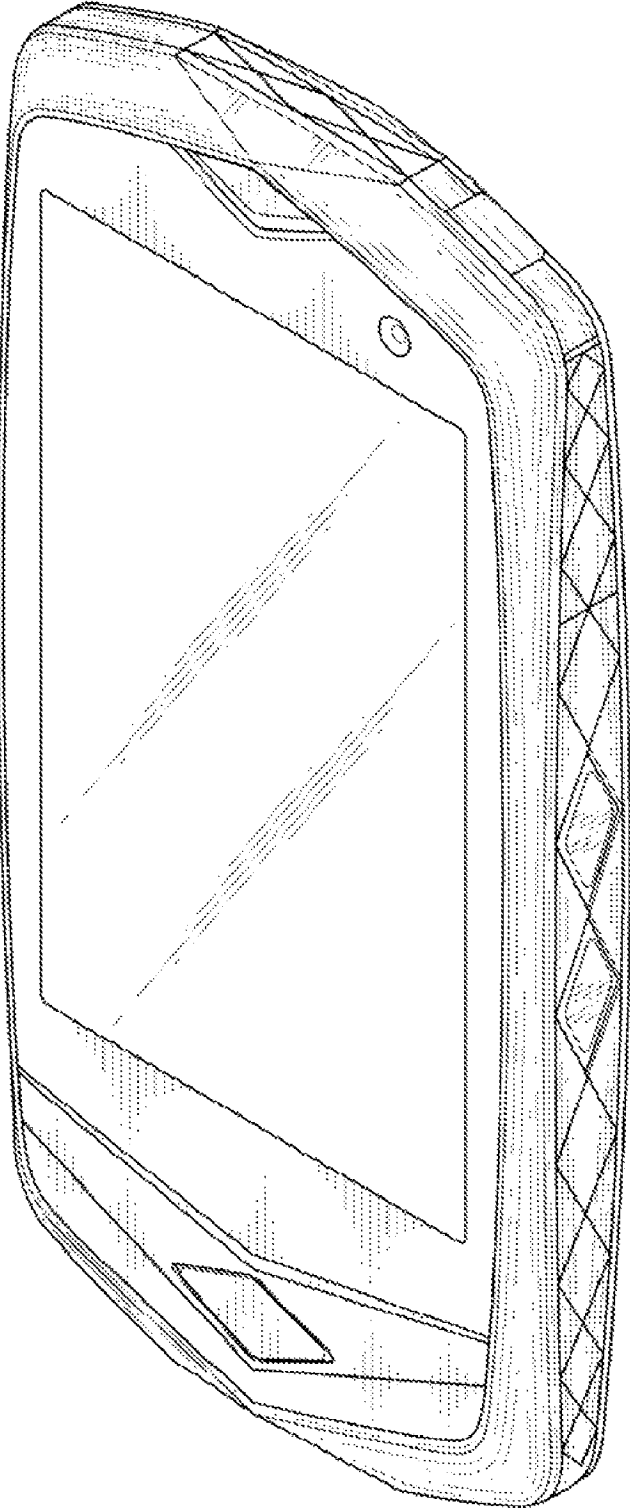

FIG.2

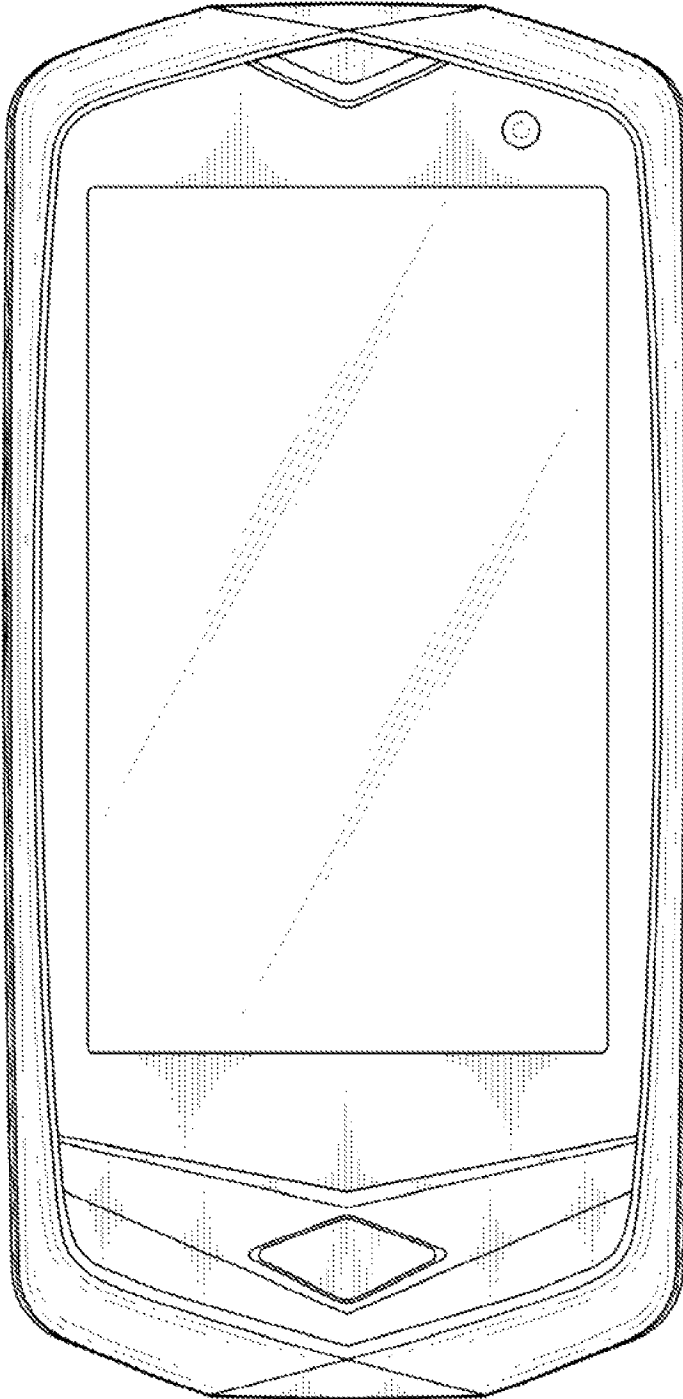

FIG.3

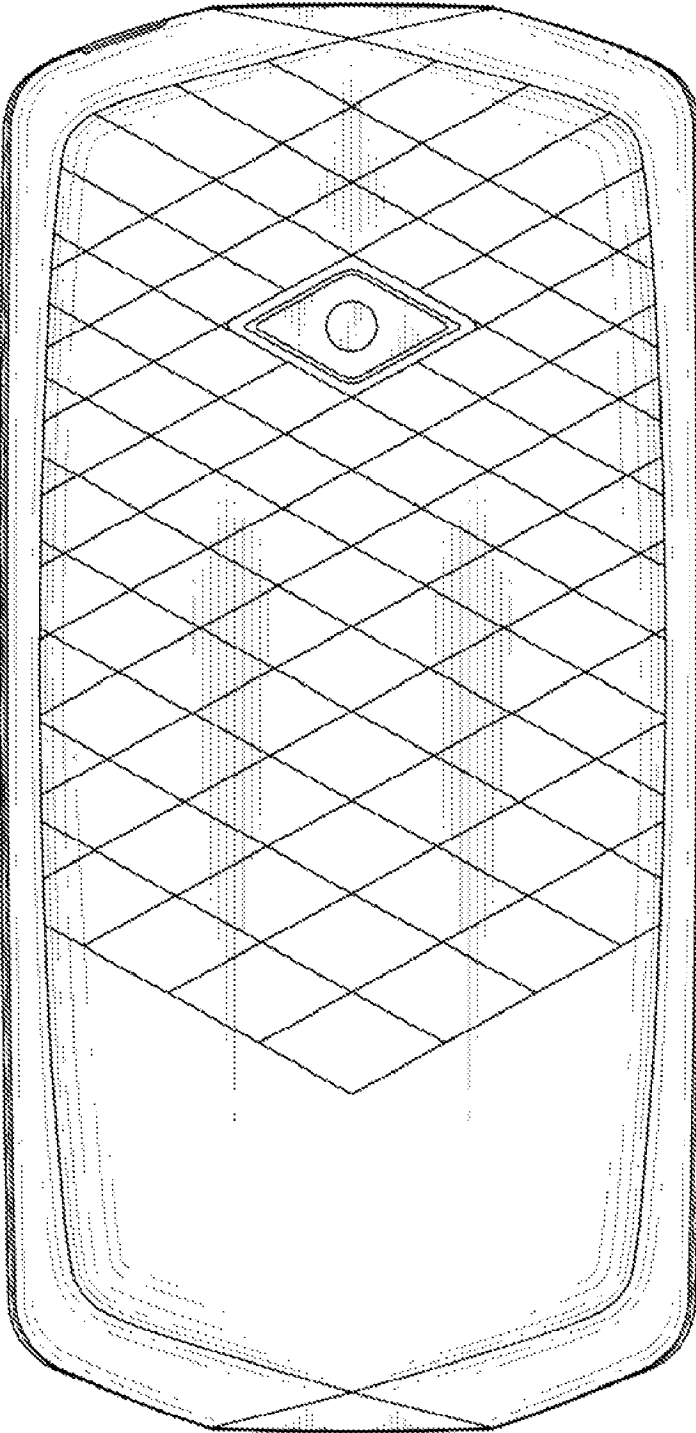

FIG.4

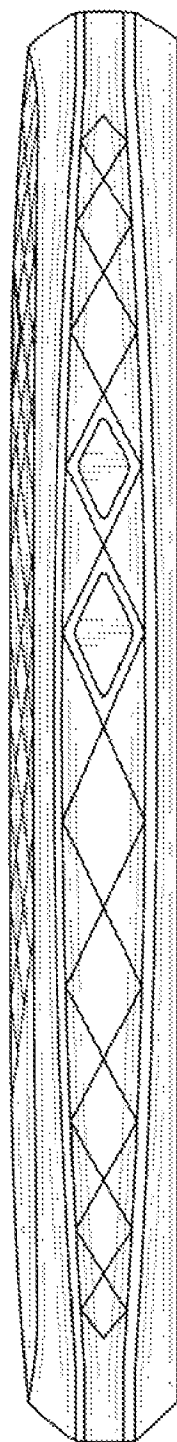

FIG. 5

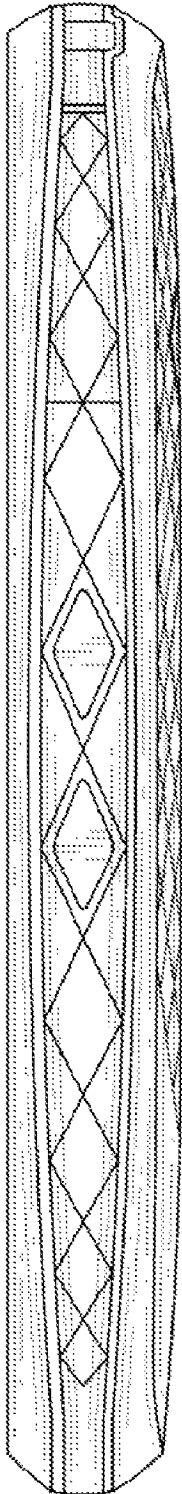

FIG.6

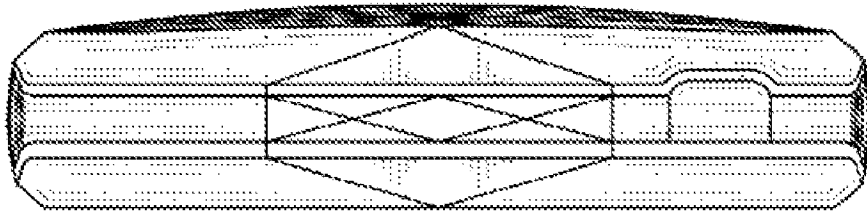
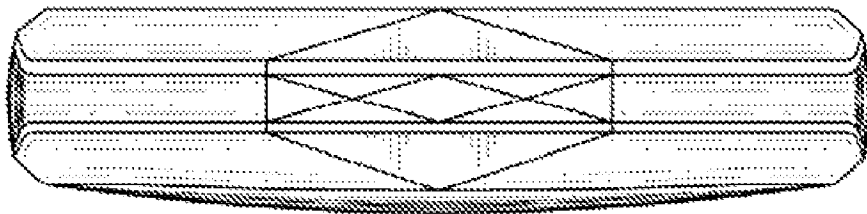

FIG.7





US00D629780S

(12) **United States Design Patent**
Woo et al.

(10) **Patent No.:** **US D629,780 S**

(45) **Date of Patent:** **** Dec. 28, 2010**

(54) **MOBILE PHONE**

(75) Inventors: **Sang-Sung Woo**, Seoul (KR); **Sang-Min Hyun**, Seoul (KR); **Jung-Hyeok Im**, Sungnam-si (KR)

(73) Assignee: **Samsung Electronics Co., Ltd.** (KR)

(**) Term: **14 Years**

(21) Appl. No.: **29/359,686**

(22) Filed: **Apr. 14, 2010**

(30) **Foreign Application Priority Data**

Jan. 22, 2010 (KR) 30-2010-0002692

(51) **LOC (9) Cl.** **14-03**

(52) **U.S. Cl.** **D14/138 G**

(58) **Field of Classification Search** D14/138 R, D14/138 AD, 138 AC, 138 C, 138 G, 191, D14/203.1-203.8, 496, 138 AA, 138 AB, D14/247-248, 137, 147, 218, 341-347; D10/65, D10/78, 104; D13/168; D18/7; 455/566, 455/575.1, 575.3

See application file for complete search history.

(56) **References Cited**

U.S. PATENT DOCUMENTS

D356,548 S *	3/1995	Bottcher et al.	D14/341
D514,558 S *	2/2006	Nagel et al.	D14/341
D524,809 S *	7/2006	Alcouloumre et al.	D14/341
D551,226 S *	9/2007	Lee et al.	D14/341
7,342,776 B1 *	3/2008	Chan	361/679.27
D572,160 S *	7/2008	Cherneck et al.	D10/104
D580,392 S *	11/2008	Kim et al.	D14/138 AD
D580,905 S *	11/2008	Park et al.	D14/138 AD
D597,092 S *	7/2009	Wang et al.	D14/346
D598,914 S *	8/2009	Song et al.	D14/345
D602,463 S *	10/2009	Eguchi	D14/138 G

D604,263 S *	11/2009	Kim	D14/138 G
D608,228 S *	1/2010	Miyawaki	D10/65
D614,601 S *	4/2010	Kataoka et al.	D14/142
D615,951 S *	5/2010	Kim et al.	D14/138 G
D618,650 S *	6/2010	Hyun et al.	D14/138 G
D619,989 S *	7/2010	Huang	D14/138 G
7,764,489 B2 *	7/2010	Kim et al.	361/679.16
2002/0107044 A1 *	8/2002	Kuwata et al.	455/550

(Continued)

OTHER PUBLICATIONS

Philips Xenium K700, announced Nov. 2009, [online], [retrieved on Dec. 7, 2009]. Retrieved from Internet, <URL: http://www.gsmarena.com>.*

(Continued)

Primary Examiner—Bridget L Eland
(74) *Attorney, Agent, or Firm*—NSIP Law

(57) **CLAIM**

The ornamental design for a mobile phone, as shown and described.

DESCRIPTION

FIG. 1 is a perspective view of a mobile phone;
FIG. 2 is a front view of the mobile phone of FIG. 1;
FIG. 3 is a rear view of the mobile phone of FIG. 1;
FIG. 4 is a left-side view of the mobile phone of FIG. 1;
FIG. 5 is a right-side view of the mobile phone of FIG. 1;
FIG. 6 is a top plan view of the mobile phone of FIG. 1; and
FIG. 7 is a bottom plan view of the mobile phone of FIG. 1.

1 Claim, 5 Drawing Sheets

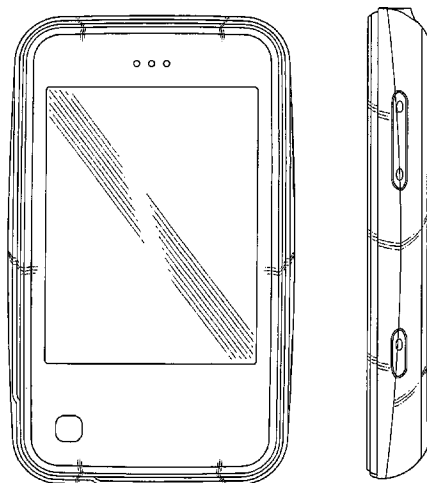

US D629,780 S

Page 2

U.S. PATENT DOCUMENTS

2002/0112250 A1* 8/2002 Koplak et al. 725/153
2004/0087346 A1* 5/2004 Johannsen et al. 455/566
2005/0054393 A1* 3/2005 Fagerstrom et al. 455/575.1
2007/0040030 A1* 2/2007 Kranzley et al. 235/451
2009/0061947 A1* 3/2009 Park et al. 455/566
2009/0286573 A1* 11/2009 Jang et al. 455/566
2010/0048253 A1* 2/2010 Park et al. 455/566

OTHER PUBLICATIONS

Philips Xenium K600, announced Apr. 2010, [online], [retrieved on Jun. 11, 2010]. Retrieved from Internet ,<URL: <http://www.gsmarena.com>>.*
LG GD510 Pop, announced Sep. 2009, [online], [retrieved on Oct. 1, 2009]. Retrieved from Internet ,<URL: <http://www.gsmarena.com>>.*

* cited by examiner

FIG. 1

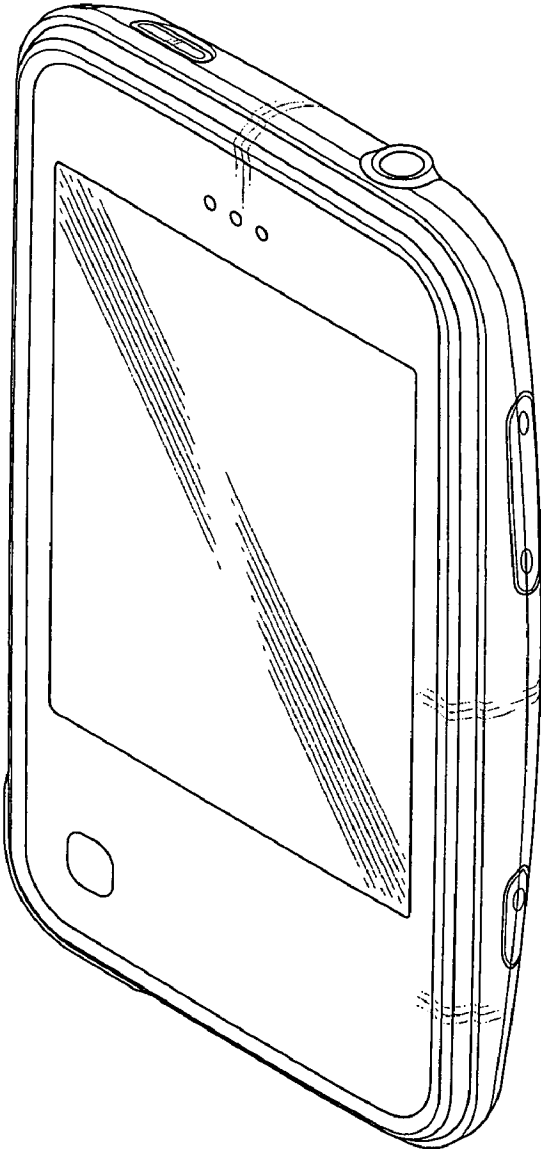

FIG. 2

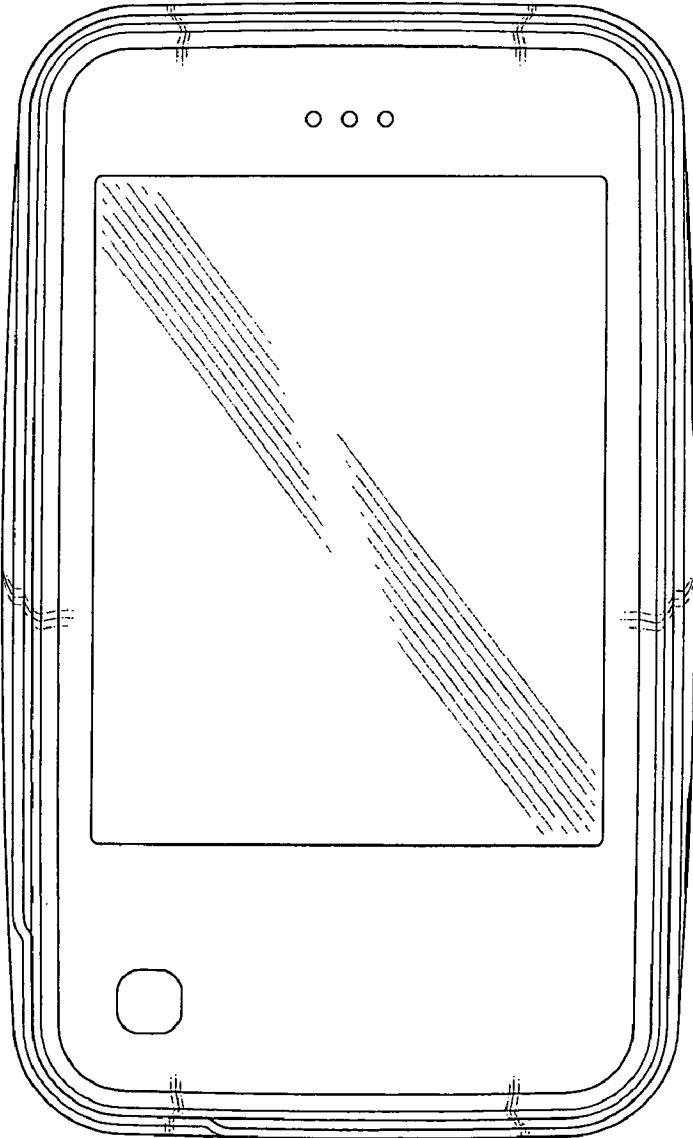

FIG. 3

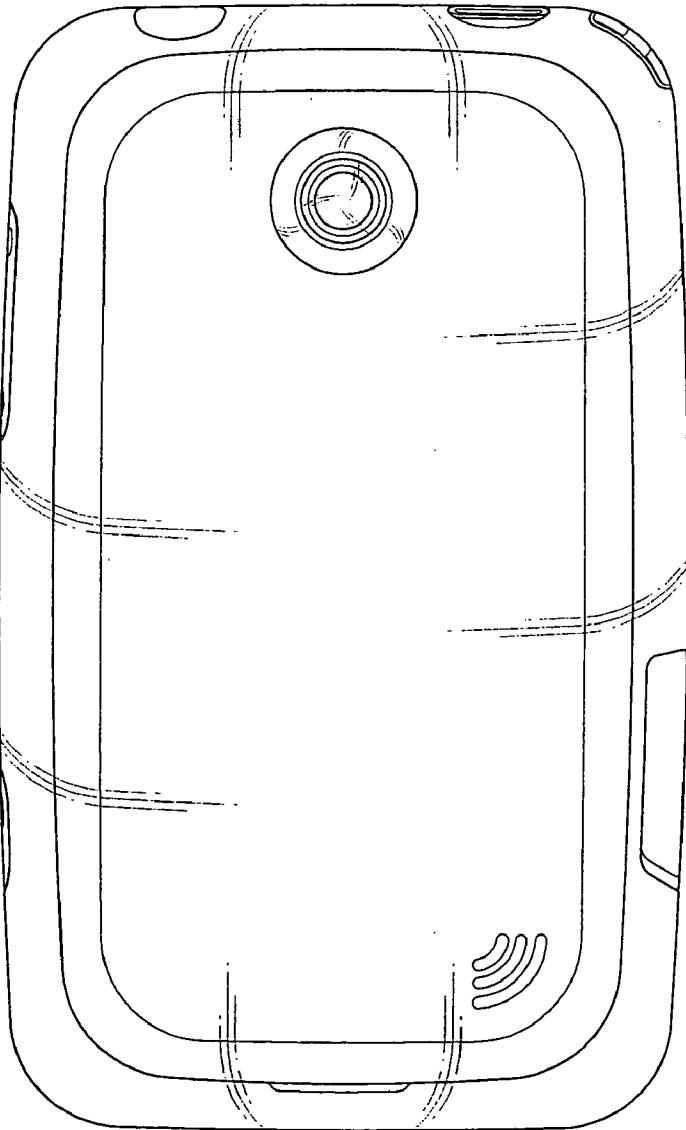

FIG. 4

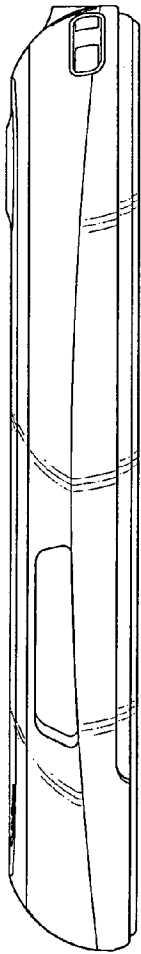

FIG. 5

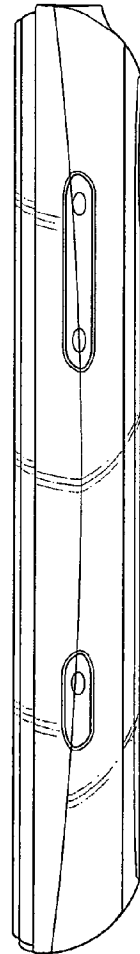

FIG. 6

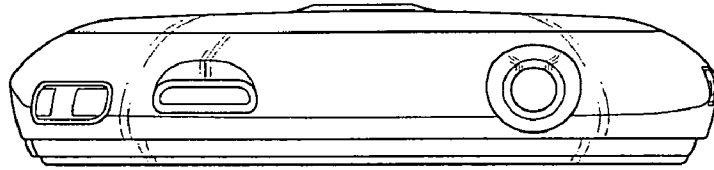

FIG. 7

