

# Exhibit 6

## Part 1 of 4

7293088



# THE UNITED STATES OF AMERICA

**TO ALL TO WHOM THESE PRESENTS SHALL COME:**

UNITED STATES DEPARTMENT OF COMMERCE

United States Patent and Trademark Office

*April 25, 2011*

**THIS IS TO CERTIFY THAT ANNEXED IS A TRUE COPY FROM THE RECORDS OF THIS OFFICE OF THE FILE WRAPPER AND CONTENTS OF:**

**APPLICATION NUMBER: 29/328,018**  
**FILING DATE: November 18, 2008**  
**PATENT NUMBER: D618677**  
**ISSUE DATE: June 29, 2010**



Certified by

*David S. Kaye*

Under Secretary of Commerce  
for Intellectual Property  
and Director of the United States  
Patent and Trademark Office

APLND00030442

## SCORE Placeholder Sheet for IFW Content

Application Number: 29328018

Document Date: 11/18/2008

The presence of this form in the IFW record indicates that the following document type was received in electronic format on the date identified above. This content is stored in the SCORE database.

- Design Drawing

Since this was an electronic submission, there is no physical artifact folder, no artifact folder is recorded in PALM, and no paper documents or physical media exist. The TIFF images in the IFW record were created from the original documents that are stored in SCORE.

To access the documents in the SCORE database, refer to instructions developed by SIRA.

At the time of document entry (noted above):

- Examiners may access SCORE content via the eDAN interface.
- Other USPTO employees can bookmark the current SCORE URL (<http://es/ScoreAccessWeb/>).
- External customers may access SCORE content via the Public and Private PAIR interfaces.

Form Revision Date: February 8, 2006

Under the Paperwork Reduction Act of 1995, no persons are required to respond to a collection of information unless it displays a valid OMB control number.

**DESIGN  
PATENT APPLICATION  
TRANSMITTAL**

Attorney Docket No.	2607.0590002(P4984USD1)/TGD/AKS
First Named Inventor	Bartley K. ANDRE
Title	Electronic Device
Express Mail Label No.	

(Only for new nonprovisional applications under 37 CFR 1.53(b))

ADDRESS TO:  
Commissioner for Patents  
P.O. Box 1450  
Alexandria, VA 22313-1450

**DESIGN V. UTILITY:** A "design patent" protects an article's ornamental appearance (e.g., the way an article looks) (35 U.S.C. 171), while a "utility patent" protects the way an article is used and works (35 U.S.C. 101). The ornamental appearance of an article includes its shape/configuration or surface ornamentation upon the article, or both. Both a design and a utility patent may be obtained on an article if invention resides both in its ornamental appearance and its utility. For more information, see MPEP 1502.01.

**APPLICATION ELEMENTS**

See MPEP 1500 concerning design patent application contents.

1.  Fee Transmittal Form (e.g., PTO/SB/17)
2.  Applicant claims small entity status. See 37 CFR 1.27.
3.  Specification [Total Pages 4]  
(preferred arrangement set forth below, MPEP 1503.01)
  - Preamble
  - Cross References to Related Applications
  - Statement Regarding Fed sponsored R & D
  - Description of the figure(s) of the drawings
  - Feature description
  - Claim (only one (1) claim permitted, MPEP 1503.03)
4.  Drawing(s) (37 CFR 1.152) [Total Sheets 8]
5. Oath or Declaration [Total Pages 8]
  - a.  Newly executed (original or copy)
  - b.  A copy from a prior application (37 CFR 1.63(d))  
(for continuation/divisional with Box 16 completed)
    - i.  DELETION OF INVENTOR(S)  
Signed statement attached deleting inventor(s) named in the prior application, see 37 CFR 1.63(d)(2) and 1.33(b)
6.  Application Data Sheet. See 37 CFR 1.76

**ACCOMPANYING APPLICATION PARTS**

7.  Assignment Papers (cover sheet & document(s))
8.  37 CFR 3.73(b) Statement (when there is an assignee)  Power of Attorney
9.  English Translation Document (if applicable)
10.  Information Disclosure Statement (IDS) PTO/SB/08 or PTO-1449  
 Copies of foreign patent documents, publications, & other information
11.  Preliminary Amendment
12.  Return Receipt Postcard (MPEP 503) (Should be specifically itemized)
13.  Certified Copy of Priority Document(s) (if foreign priority is claimed)
14.  Request for Expedited Examination of a Design Application (37 CFR 1.155) (NOTE: Use "Mail Stop Expedited Design")
15.  Other: Authorization under 37 CFR 1.136(a)(3)

16. If a CONTINUING APPLICATION, check appropriate box, and supply the requisite information below and in the first sentence of the specification following the title, or in an Application Data Sheet under 37 CFR 1.76:

Continuation  Divisional  Continuation-in-part (CIP) of prior application No.: 29/282,834

Prior application information: Examiner Angela J. Lee Art Unit: 2911

**17. CORRESPONDENCE ADDRESS**

The address associated with Customer Number: 63975 OR  Correspondence address below

Name			
Address			
City	State	Zip Code	
Country	Telephone	Email	

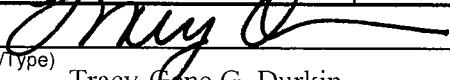
Signature		Date	November 18, 2008
Name (Print/Type)	Tracy-Gene G. Durkin	Registration No. (Attorney/Agent)	32,831

This collection of information is required by 37 CFR 1.53(b). The information is required to obtain or retain a benefit by the public which is to file (and by the USPTO to process) an application. Confidentiality is governed by 35 U.S.C. 122 and 37 CFR 1.11 and 1.14. This collection is estimated to take 12 minutes to complete, including gathering, preparing, and submitting the completed application form to the USPTO. Time will vary depending upon the individual case. Any comments on the amount of time you require to complete this form and/or suggestions for reducing this burden, should be sent to the Chief Information Officer, U.S. Patent and Trademark Office, U.S. Department of Commerce, P.O. Box 1450, Alexandria, VA 22313-1450. DO NOT SEND FEES OR COMPLETED FORMS TO THIS ADDRESS. SEND TO: Commissioner for Patents, P.O. Box 1450, Alexandria, VA 22313-1450.

If you need assistance in completing the form, call 1-800-PTO-9199 and select option 2.

## APPLICATION DATA SHEET

Electronic Version v14  
Stylesheet Version v14.1

### *Applicant Information:*

#### Inventor 1:

<b>Applicant Authority Type:</b>	Inventor
<b>Citizenship:</b>	US
<b>Given Name:</b>	Bartley
<b>Middle Name:</b>	K.
<b>Family Name:</b>	ANDRE
<b>City of Residence:</b>	Menlo Park
<b>State of Residence:</b>	CA
<b>Country of Residence:</b>	US
<b>Address-1 of Mailing Address:</b>	333 Pope Street
<b>Address-2 of Mailing Address:</b>	
<b>City of Mailing Address:</b>	Menlo Park
<b>State of Mailing Address:</b>	CA
<b>Postal Code of Mailing Address:</b>	94025
<b>Country of Mailing Address:</b>	US
<b>Phone:</b>	
<b>Fax:</b>	
<b>E-mail:</b>	

#### Inventor 2:

<b>Applicant Authority Type:</b>	Inventor
<b>Citizenship:</b>	NZ
<b>Given Name:</b>	Daniel
<b>Middle Name:</b>	J.
<b>Family Name:</b>	COSTER
<b>City of Residence:</b>	San Francisco
<b>State of Residence:</b>	CA
<b>Country of Residence:</b>	US
<b>Address-1 of Mailing Address:</b>	756 Church Street
<b>Address-2 of Mailing Address:</b>	
<b>City of Mailing Address:</b>	San Francisco
<b>State of Mailing Address:</b>	CA

**Postal Code of Mailing Address:** 94114  
**Country of Mailing Address:** US  
**Phone:**  
**Fax:**  
**E-mail:**

Inventor 3:

**Applicant Authority Type:** Inventor  
**Citizenship:** IT  
**Given Name:** Daniele  
**Family Name:** DE IULIIS  
**City of Residence:** San Francisco  
**State of Residence:** CA  
**Country of Residence:** US  
**Address-1 of Mailing Address:** 50 Digby Street  
**Address-2 of Mailing Address:**  
**City of Mailing Address:** San Francisco  
**State of Mailing Address:** CA  
**Postal Code of Mailing Address:** 94131  
**Country of Mailing Address:** US  
**Phone:**  
**Fax:**  
**E-mail:**

Inventor 4:

**Applicant Authority Type:** Inventor  
**Citizenship:** GB  
**Given Name:** Richard  
**Middle Name:** P.  
**Family Name:** HOWARTH  
**City of Residence:** San Francisco  
**State of Residence:** CA  
**Country of Residence:** US  
**Address-1 of Mailing Address:** 3928 17th Street  
**Address-2 of Mailing Address:**  
**City of Mailing Address:** San Francisco  
**State of Mailing Address:** CA

**Postal Code of Mailing Address:** 94114  
**Country of Mailing Address:** US  
**Phone:**  
**Fax:**  
**E-mail:**

Inventor 5:

**Applicant Authority Type:** Inventor  
**Citizenship:** GB  
**Given Name:** Jonathan  
**Middle Name:** P.  
**Family Name:** IVE  
**City of Residence:** San Francisco  
**State of Residence:** CA  
**Country of Residence:** US  
**Address-1 of Mailing Address:** 196 Twin Peaks Blvd.  
**Address-2 of Mailing Address:**  
**City of Mailing Address:** San Francisco  
**State of Mailing Address:** CA  
**Postal Code of Mailing Address:** 94114  
**Country of Mailing Address:** US  
**Phone:**  
**Fax:**  
**E-mail:**

Inventor 6:

**Applicant Authority Type:** Inventor  
**Citizenship:** US  
**Given Name:** Steve  
**Family Name:** JOBS  
**City of Residence:** Palo Alto  
**State of Residence:** CA  
**Country of Residence:** US  
**Address-1 of Mailing Address:** 2101 Waverley Street  
**Address-2 of Mailing Address:**  
**City of Mailing Address:** Palo Alto  
**State of Mailing Address:** CA

**Postal Code of Mailing Address:** 94301  
**Country of Mailing Address:** US  
**Phone:**  
**Fax:**  
**E-mail:**

Inventor 7:

**Applicant Authority Type:** Inventor  
**Citizenship:** GB  
**Given Name:** Duncan  
**Middle Name:** Robert  
**Family Name:** KERR  
**City of Residence:** San Francisco  
**State of Residence:** CA  
**Country of Residence:** US  
**Address-1 of Mailing Address:** 73 Miguel Street  
**Address-2 of Mailing Address:**  
**City of Mailing Address:** San Francisco  
**State of Mailing Address:** CA  
**Postal Code of Mailing Address:** 94131  
**Country of Mailing Address:** US  
**Phone:**  
**Fax:**  
**E-mail:**

Inventor 8:

**Applicant Authority Type:** Inventor  
**Citizenship:** JP  
**Given Name:** Shin  
**Family Name:** NISHIBORI  
**City of Residence:** Portola Valley  
**State of Residence:** CA  
**Country of Residence:** US  
**Address-1 of Mailing Address:** 28 Aliso Way  
**Address-2 of Mailing Address:**  
**City of Mailing Address:** Portola Valley  
**State of Mailing Address:** CA



**Postal Code of Mailing Address:** 94208  
**Country of Mailing Address:** US  
**Phone:**  
**Fax:**  
**E-mail:**

Inventor 9:

**Applicant Authority Type:** Inventor  
**Citizenship:** US  
**Given Name:** Matthew  
**Middle Name:** Dean  
**Family Name:** ROHRBACH  
**City of Residence:** San Francisco  
**State of Residence:** CA  
**Country of Residence:** US  
**Address-1 of Mailing Address:** 29 Ora Way  
**Address-2 of Mailing Address:**  
**City of Mailing Address:** San Francisco  
**State of Mailing Address:** CA  
**Postal Code of Mailing Address:** 94131  
**Country of Mailing Address:** US  
**Phone:**  
**Fax:**  
**E-mail:**

Inventor 10:

**Applicant Authority Type:** Inventor  
**Citizenship:** US  
**Given Name:** Douglas  
**Middle Name:** B.  
**Family Name:** SATZGER  
**City of Residence:** Menlo Park  
**State of Residence:** CA  
**Country of Residence:** US  
**Address-1 of Mailing Address:** 225 Arden Road  
**Address-2 of Mailing Address:**  
**City of Mailing Address:** Menlo Park

**State of Mailing Address:** CA  
**Postal Code of Mailing Address:** 94025  
**Country of Mailing Address:** US  
**Phone:**  
**Fax:**  
**E-mail:**

Inventor 11:

**Applicant Authority Type:** Inventor (Deceased)  
**Citizenship:** US  
**Given Name:** Calvin  
**Middle Name:** Q.  
**Family Name:** SEID  
**City of Residence:** Palo Alto  
**State of Residence:** CA  
**Country of Residence:** US  
**Address-1 of Mailing Address:** 1043 High Street  
**Address-2 of Mailing Address:**  
**City of Mailing Address:** Palo Alto  
**State of Mailing Address:** CA  
**Postal Code of Mailing Address:** 94301  
**Country of Mailing Address:** US  
**Phone:**  
**Fax:**  
**E-mail:**

Inventor 12:

**Applicant Authority Type:** Inventor  
**Citizenship:** AU  
**Given Name:** Christopher  
**Middle Name:** J.  
**Family Name:** STRINGER  
**City of Residence:** Woodside  
**State of Residence:** CA  
**Country of Residence:** US  
**Address-1 of Mailing Address:** 20100 Skyline Boulevard  
**Address-2 of Mailing Address:**

**City of Mailing Address:** Woodside  
**State of Mailing Address:** CA  
**Postal Code of Mailing Address:** 94062  
**Country of Mailing Address:** US  
**Phone:**  
**Fax:**  
**E-mail:**

Inventor 13:

**Applicant Authority Type:** Inventor  
**Citizenship:** CA  
**Given Name:** Eugene  
**Middle Name:** Antony  
**Family Name:** WHANG  
**City of Residence:** San Francisco  
**State of Residence:** CA  
**Country of Residence:** US  
**Address-1 of Mailing Address:** #1-400 Dolores Street  
**Address-2 of Mailing Address:**  
**City of Mailing Address:** San Francisco  
**State of Mailing Address:** CA  
**Postal Code of Mailing Address:** 94114  
**Country of Mailing Address:** US  
**Phone:**  
**Fax:**  
**E-mail:**

Inventor 14:

**Applicant Authority Type:** Inventor  
**Citizenship:** DE  
**Given Name:** Rico  
**Family Name:** ZORKENDORFER  
**City of Residence:** San Francisco  
**State of Residence:** CA  
**Country of Residence:** US  
**Address-1 of Mailing Address:** 327 Lombard Street  
**Address-2 of Mailing Address:**

**City of Mailing Address:** San Francisco  
**State of Mailing Address:** CA  
**Postal Code of Mailing Address:** 94133  
**Country of Mailing Address:** US  
**Phone:**  
**Fax:**  
**E-mail:**

***Correspondence Information:***

**Customer Number:** 63975 \*63975\*

***Application Information:***

**Title of Invention:** Electronic Device  
**Application Type:** regular, design  
**Attorney Docket Number:** 2607.0590002(P4984USD1)/TGD/AKS

Botanic Information:

Publication Information:

**Suggested Figure for Publication -**  
**Suggested Classification -**  
**Suggested Technology Center -**  
**Total Number of Drawing Sheets - 8**

***Representative Information:***

practitioner(s) at Customer Number:

63975 \*63975\*

as our attorney(s) or agent(s) to prosecute the application identified above, and to transact all business in the United States Patent and Trademark Office connected therewith.

***Domestic Priority Information:***

This is a Divisional of US application number 29/282,834, filed 2007-07-30.

US application number 29/282,834, filed 2007-07-30 is a Continuation of US application number

29/270,888, filed 2007-01-05, now U.S. Patent D558,758.

***Foreign Priority Information:***

***Assignee Information:***

Assignee 1:

**Organization Name:** Apple Inc.  
**Address-1 of Mailing Address:** 1 Infinite Loop  
**Address-2 of Mailing Address:**  
**City of Mailing Address:** Cupertino  
**State of Mailing Address:** CA  
**Postal Code of Mailing Address:** 95014  
**Country of Mailing Address:** US  
**Phone:**  
**Fax:**  
**E-mail:**

Respectfully submitted,

STERNE, KESSLER, GOLDSTEIN & FOX P.L.L.C.



Tracy-Gene G. Durkin  
Attorney for Applicants  
Registration No. 32,831

Date: November 18, 2008

1100 New York Avenue, N.W.  
Washington, D.C. 20005-3934  
(202) 371-2600

902151\_1.DOC

APLNDC00030453

## SPECIFICATION

[0001] This application is a divisional application of U.S. Design Patent  
Application No. 29/282,834, filed July 30, 2007 (pending), which is a  
continuation application of U.S. Design Patent Application No. 29/270,888,  
[0002] filed January 5, 2007 (now U.S. Patent No. Des. 558,758), the disclosures of  
which are all hereby incorporated in their entirety by reference thereto.

This is an application for a new, original, and ornamental design for an  
[0003] ELECTRONIC DEVICE, of which the following is a specification, reference  
being had to the accompanying drawings, forming a part thereof.

[0004] Figure 1 is a front perspective view of an electronic device in  
[0005] accordance with the present invention;

[0006] Figure 2 is a rear perspective view thereof;

[0007] Figure 3 is a front view thereof;

[0008] Figure 4 is a rear view thereof;

[0009] Figure 5 is a top view thereof;

[0010] Figure 6 is bottom view thereof;

[0011] Figure 7 is a left side view thereof;

Figure 8 is a right side view thereof;

[0012] Figure 9 is a front perspective view of an electronic device in

[0013] accordance with the present invention;

[0014] Figure 10 is a rear perspective view thereof;

[0015] Figure 11 is a front view thereof;

[0016] Figure 12 is a rear view thereof;

[0017] Figure 13 is a top view thereof;

- [0018] Figure 14 is bottom view thereof;
- [0019] Figure 15 is a left side view thereof; and  
Figure 16 is a right side view thereof.
- [0020] Figure 17 is a front perspective view of an electronic device in  
accordance with the present invention;
- [0021] Figure 18 is a rear perspective view thereof;
- [0022] Figure 19 is a front view thereof;
- [0023] Figure 20 is a rear view thereof;
- [0024] Figure 21 is a top view thereof;
- [0025] Figure 22 is bottom view thereof;
- [0026] Figure 23 is a left side view thereof;
- [0027] Figure 24 is a right side view thereof;
- [0028] Figure 25 is a front perspective view of an electronic device in  
accordance with the present invention;
- [0029] Figure 26 is a rear perspective view thereof;
- [0030] Figure 27 is a front view thereof;
- [0031] Figure 28 is a rear view thereof;
- [0032] Figure 29 is a top view thereof;
- [0033] Figure 30 is bottom view thereof;
- [0034] Figure 31 is a left side view thereof; and
- [0035] Figure 32 is a right side view thereof.
- [0036] The features shown in broken lines in the various Figures are for  
illustrating environmental structure and form no part of the claimed design.  
The dot dash lines in Figures 9 & 11 represent an indeterminate length.
- [0037] The surfaces of the electronic device are illustrated with color

designations. The grid pattern indicates the color black, the dashed line pattern indicates metal. By way of example, the metallic portions may be selected from steel, aluminum, anodized aluminum, chrome, nickel, and/or the like.

**[0038]** More generally, the invention pertains to an ornamental design for an article of manufacture. The article is not limited to the scale shown herein. As indicated in the title, the article of manufacture to which the ornamental design has been applied is an electronic device, media player (e.g., music, video and/or game player), media storage device, a personal digital assistant, a communication device (e.g., cellular phone), a novelty item or toy.



WE CLAIM:

The ornamental design of an electronic device, as shown and described.

895429\_1.DOC

IN THE UNITED STATES PATENT AND TRADEMARK OFFICE

In re application of:

ANDRE *et al.*

Appl. No.: *To be assigned*  
(Divisional of Appl. No. 29/282,834;  
Filed July 30, 2007)

Filed: *Herewith*

For: **Electronic Device**

Confirmation No.: *To be assigned*

Art Unit: *To be assigned*

Examiner: *To be assigned*

Atty. Docket: 2607.0590002(P4984USD1)/TGD/AKS

**Authorization to Treat a Reply as Incorporating an  
Extension of Time Under 37 C.F.R. § 1.136(a)(3)**

Commissioner for Patents  
PO Box 1450  
Alexandria, VA 22313-1450

Sir:

The U.S. Patent and Trademark Office is hereby authorized to treat any concurrent or future reply that requires a petition for an extension of time under this paragraph for its timely submission, as incorporating a petition for extension of time for the appropriate length of time. The U.S. Patent and Trademark Office is hereby authorized to charge all required extension of time fees to our Deposit Account No. 19-0036, if such fees are not otherwise provided for in such reply.

Respectfully submitted,

STERNE, KESSLER, GOLDSTEIN & FOX P.L.L.C.



Tracy-Gene J. Durkin  
Attorney for Applicants  
Registration No. 32,831

Date: November 18, 2008

1100 New York Avenue, N.W.  
Washington, D.C. 20005-3934  
(202) 371-2600

902150\_1.DOC

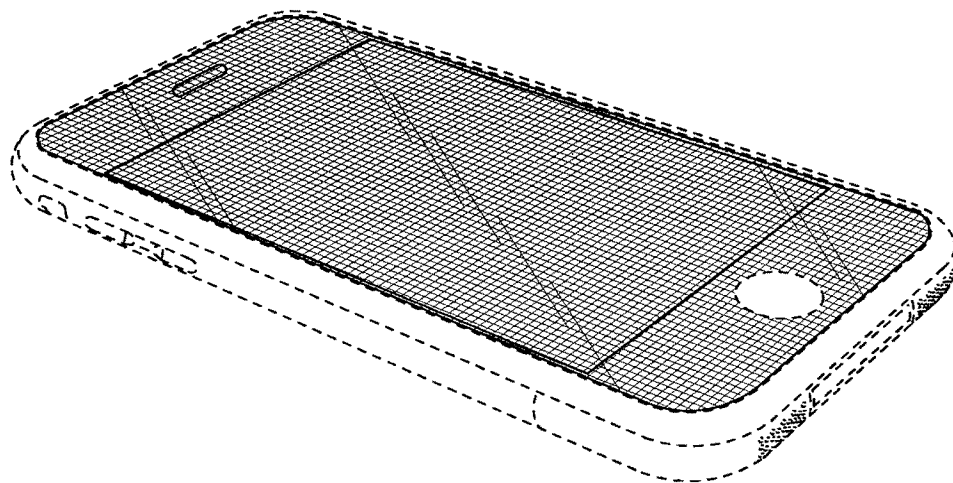

**FIG. 1**

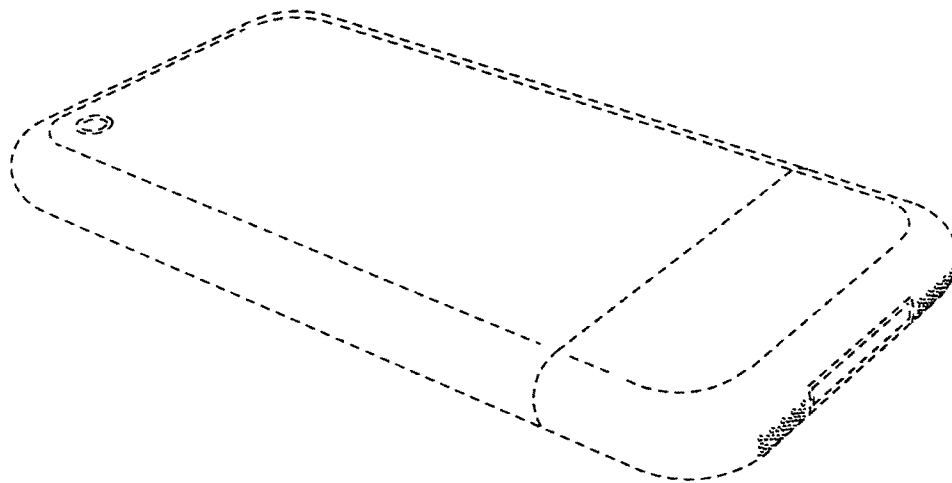

**FIG. 2**

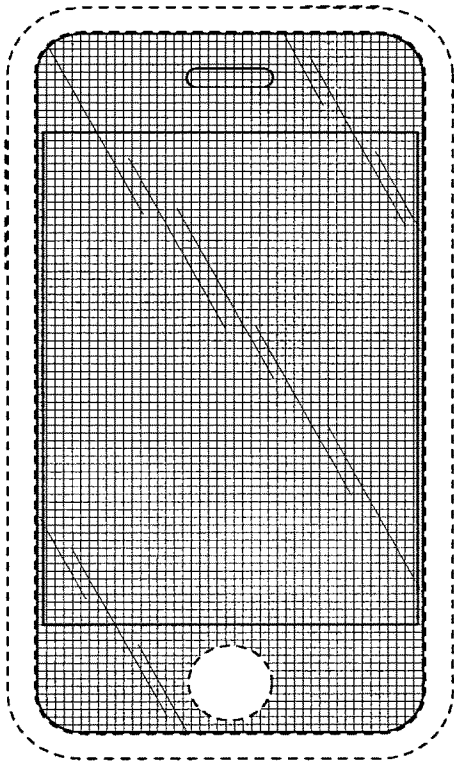

**FIG. 3**

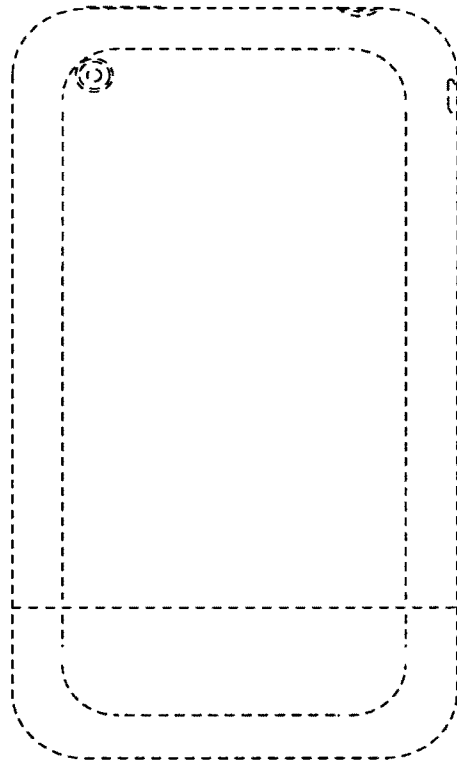

**FIG. 4**

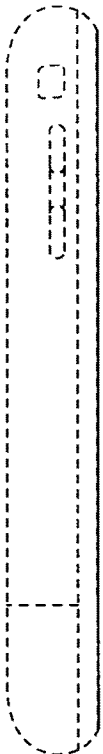

**FIG. 7**

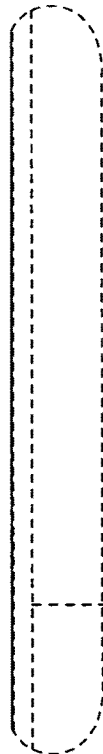

**FIG. 8**



**FIG. 5**



**FIG. 6**

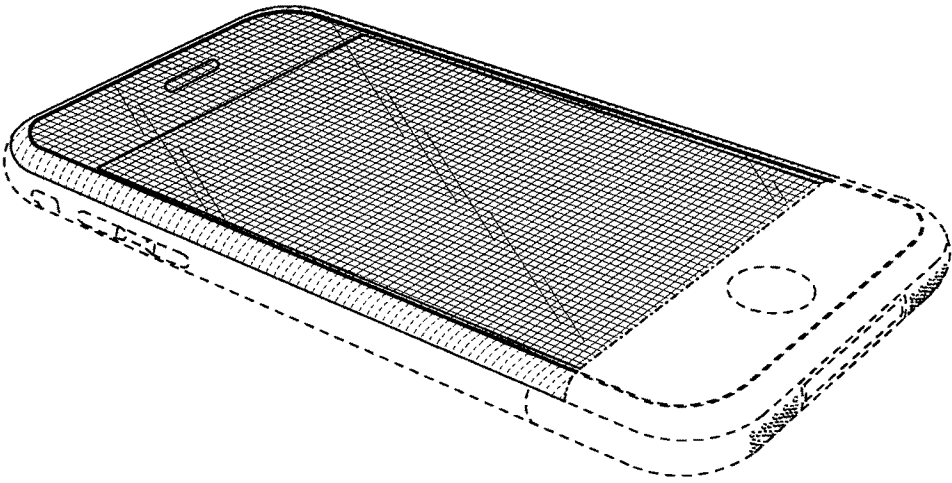

**FIG. 9**

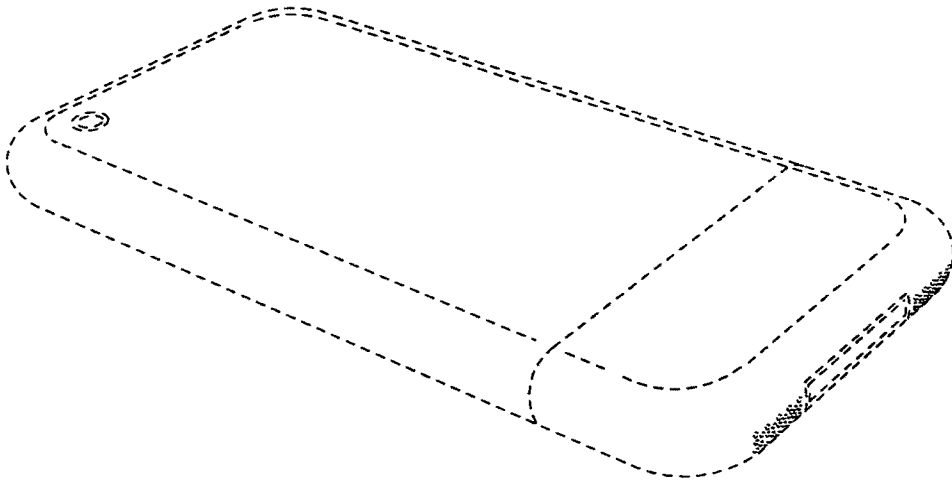

**FIG. 10**

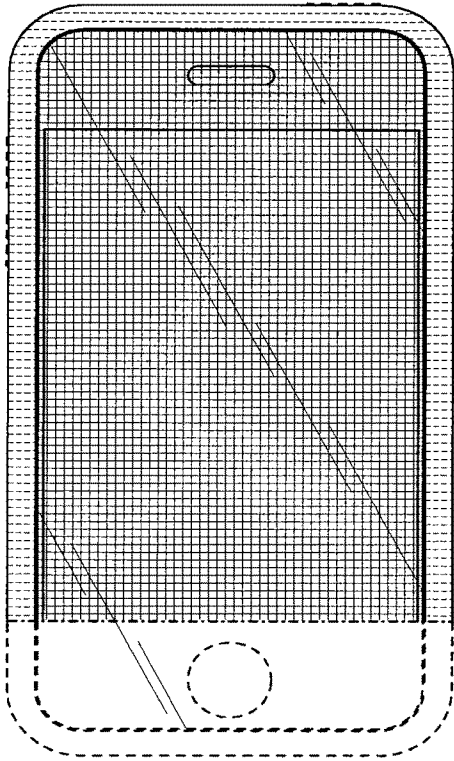

**FIG. 11**

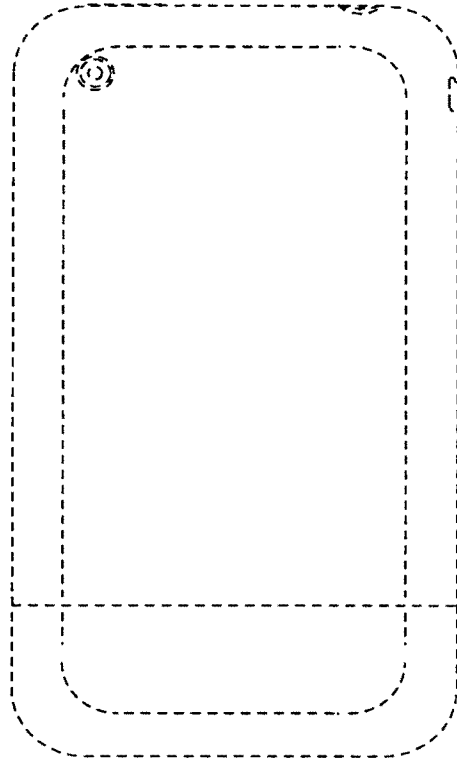

**FIG. 12**

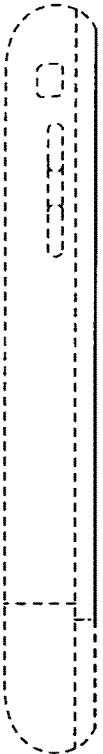

**FIG. 15**

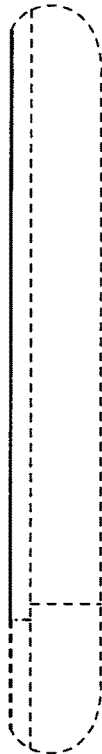

**FIG. 16**



**FIG. 13**



**FIG. 14**

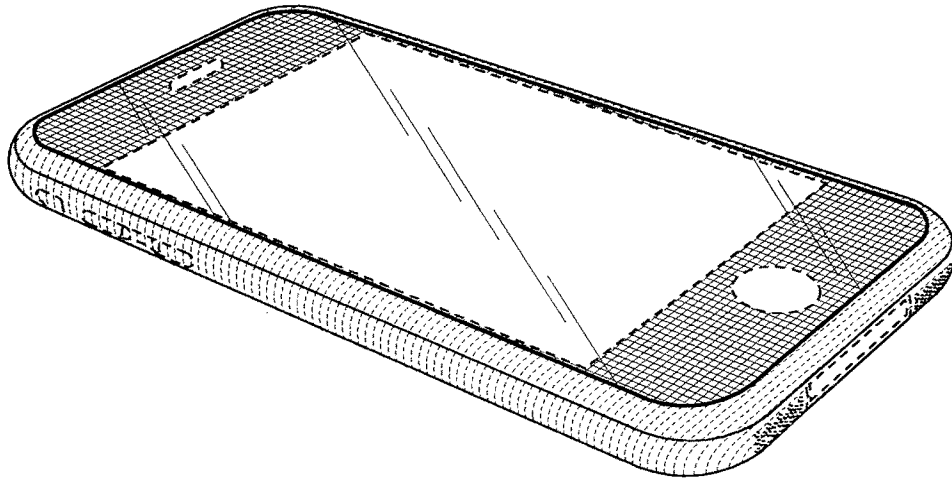

**FIG. 17**

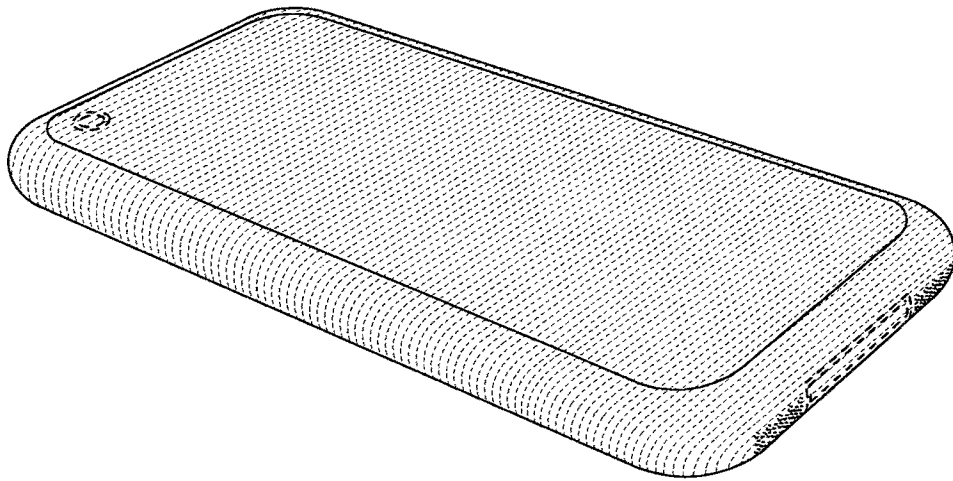

**FIG. 18**

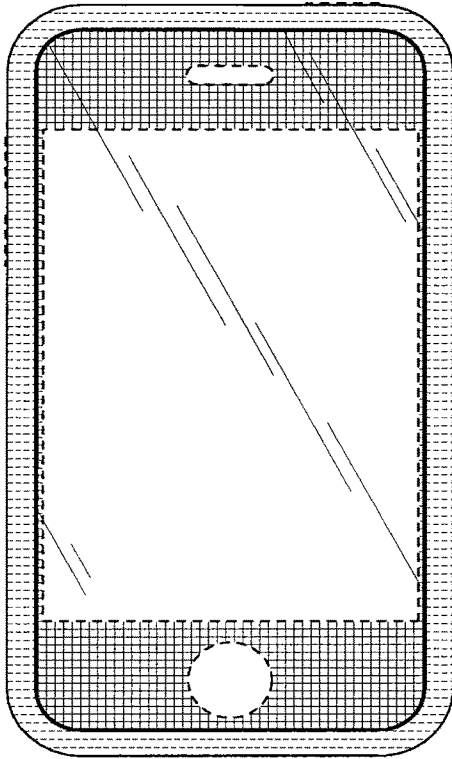

**FIG. 19**

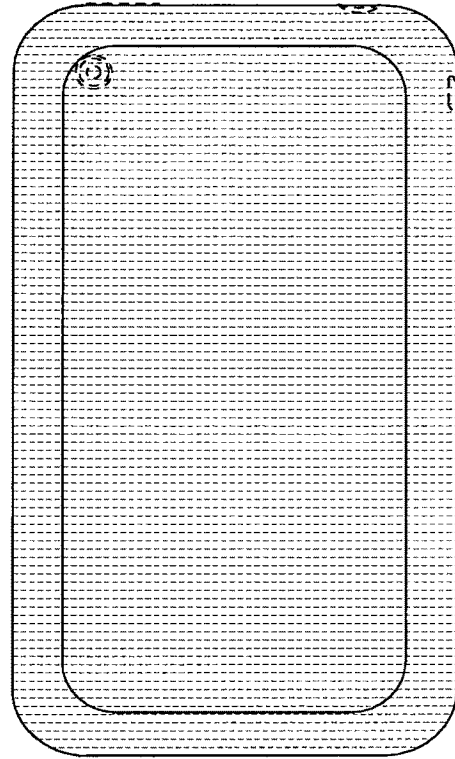

**FIG. 20**

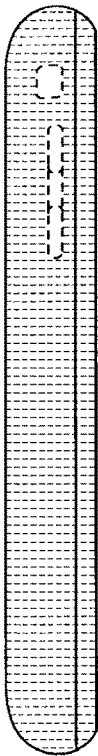

**FIG. 23**

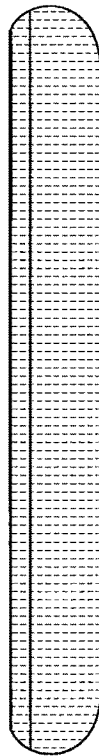

**FIG. 24**

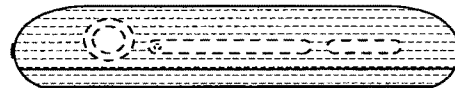
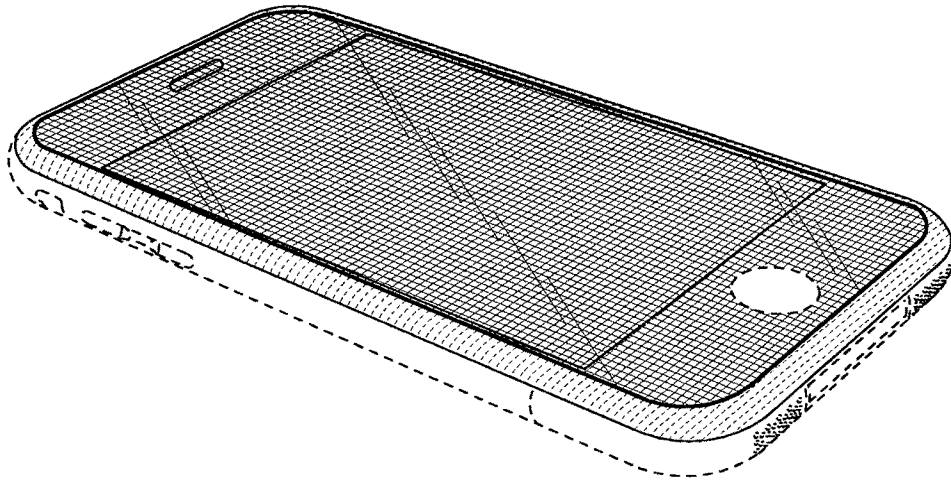

**FIG. 21**

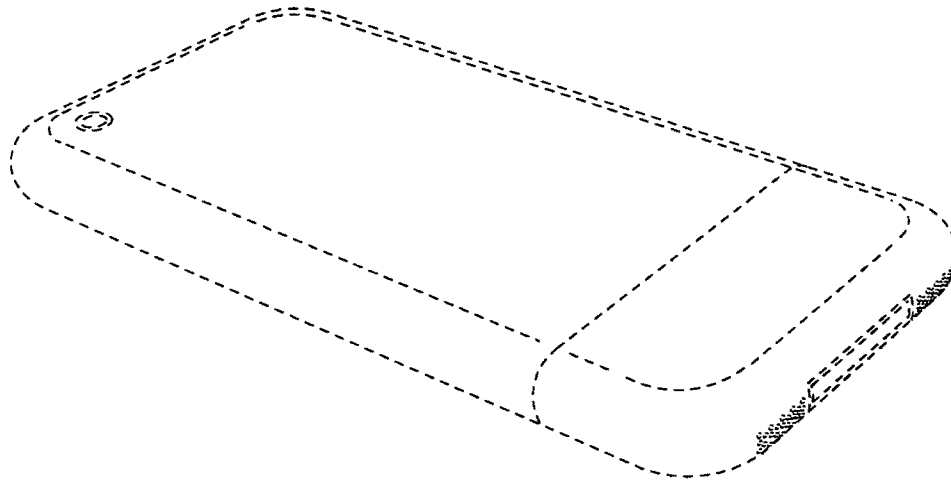

**FIG. 22**

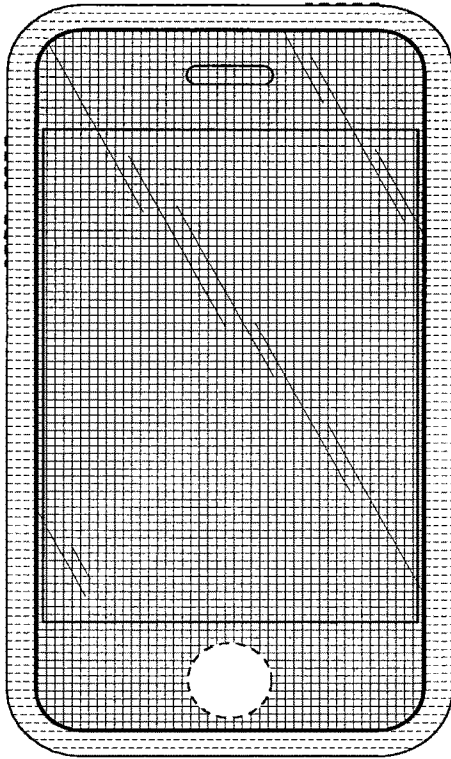



**FIG. 25**



**FIG. 26**



**FIG. 27**

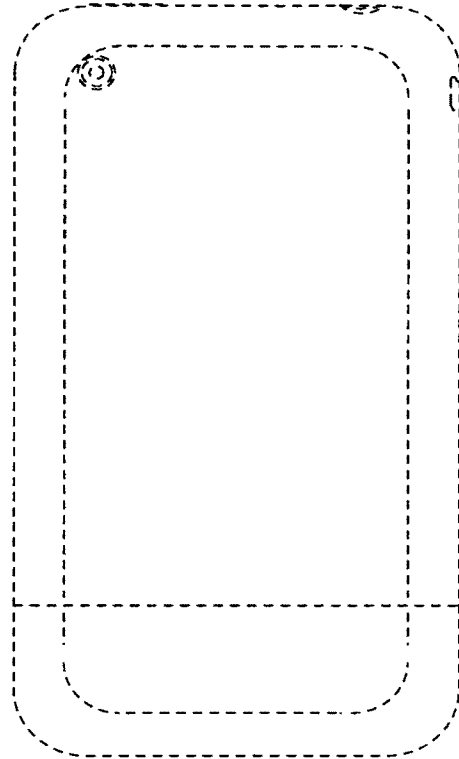

**FIG. 28**

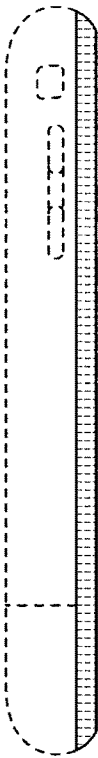

**FIG. 31**

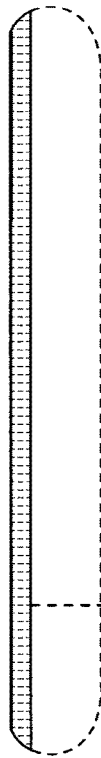

**FIG. 32**

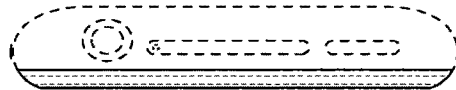

**FIG. 29**

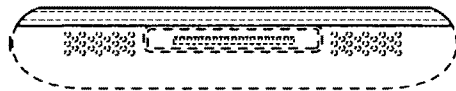

**FIG. 30**

## DECLARATION FOR ORIGINAL U.S. PATENT APPLICATION

As a below-named inventor, I hereby declare that:

My residence, post office address and citizenship are as stated below next to my name.

I believe that I am the original, first and joint inventor of the subject matter which is claimed and for which a patent is sought on the invention entitled: ELECTRONIC DEVICE, the specification of which,

- (check one)
1.  is attached hereto.
  2.  was filed on January 5, 2007 as  
U.S. Application No. 29/270,888.
  3.  was filed on \_\_\_\_\_ as  
PCT International Application No. \_\_\_\_\_  
and was amended on \_\_\_\_\_.

I hereby state that I have reviewed and understand the contents of the above-identified specification, including the claims, as amended by any amendment referred to above.

I acknowledge the duty to disclose information which is material to patentability as defined in 37 CFR 1.56, including for continuation-in-part applications, material information which became available between the filing date of the prior application and the national or PCT international filing date of the continuation-in-part application.

### Prior Foreign Application(s)

I hereby claim foreign priority benefits under Title 35, United States Code, §119(a)-(d) or (f), or §365(b) of any foreign application for patent or inventor's certificate listed below, or under §365(a) of any PCT international application which designated at least one country other than the United States listed below, and I have identified below, by checking the box, any foreign application for patent or inventor's certificate, or any PCT International application having a filing date before that of the application on which priority is claimed:

			Priority Not Claimed	Cert. Copy Attached
_____	_____	_____	<input type="checkbox"/>	<input type="checkbox"/>
(Application No.)	(Country)	(Filing Date)		
_____	_____	_____	<input type="checkbox"/>	<input type="checkbox"/>
(Application No.)	(Country)	(Filing Date)		

Direct Correspondence To:

Customer Number: 062464

Direct Telephone Calls To:

Michael J. Ferrazano at telephone number (408) 255-8001

I hereby declare that all statements made herein of my own knowledge are true and that all statements made on information and belief are believed to be true; and further that these statements were made with the knowledge that willful false statements and the like so made are punishable by fine or imprisonment, or both, under section 1001 of Title 18 of the United States Code, and that such willful false statements may jeopardize the validity of the application or any patent issuing thereon.

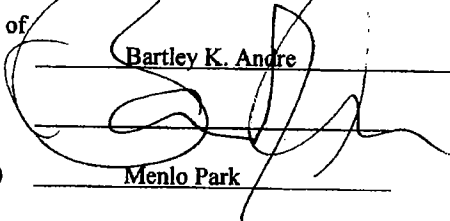
Typewritten Full Name of First Inventor: Bartley K. Andre Citizenship: U.S.  
Inventor's signature:  Date of Signature: 03/27/07  
Residence: (City) Menlo Park (State/Country) CA/U.S.  
Address: 655 Fourteenth Ave., Menlo Park, CA 94025

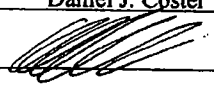
Typewritten Full Name of Second Inventor: Daniel J. Coster Citizenship: New Zealand  
Inventor's signature:  Date of Signature: 03-27-06  
Residence: (City) San Francisco (State/Country) CA/U.S.  
Address: 471 14<sup>th</sup> Street, San Francisco, CA 94103

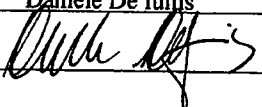
Typewritten Full Name of Third Inventor: Daniele De Iuljis Citizenship: IT  
Inventor's signature:  Date of Signature: 03/22/07  
Residence: (City) San Francisco (State/Country) CA/U.S.  
Address: 50 Digby Street, San Francisco, CA 94131

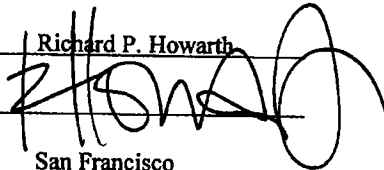
Typewritten Full Name of Fourth Inventor: Richard P. Howarth Citizenship: Great Britain  
Inventor's signature:  Date of Signature: 3-27-07  
Residence: (City) San Francisco (State/Country) CA/U.S.  
Address: 3928 17<sup>th</sup> Street, San Francisco, CA 94114

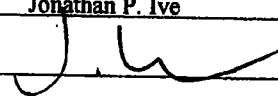
Typewritten Full Name of Fifth Inventor: Jonathan P. Ive Citizenship: Great Britain  
Inventor's signature:  Date of Signature: 3-30-07  
Residence: (City) San Francisco (State/Country) CA/U.S.  
Address: 196 Twin Peaks Blvd., San Francisco, CA 94114

Typewritten Full Name of Sixth Inventor: Steve Jobs Citizenship: U.S.  
Inventor's signature: \_\_\_\_\_ Date of Signature: \_\_\_\_\_  
Residence: (City) Palo Alto (State/Country) CA/U.S.  
Address: 2101 Waverley Street, Palo Alto, CA 94301

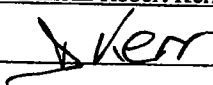
Typewritten Full Name of Seventh Inventor: Duncan Robert Kerr Citizenship: Great Britain  
Inventor's signature:  Date of Signature: 3-29-07  
Residence: (City) San Francisco (State/Country) CA/U.S.  
Address: 2600 18<sup>th</sup> Street, #15, San Francisco, CA 94110

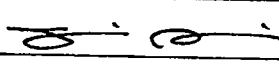
Typewritten Full Name of Eighth Inventor: Shin Nishibori Citizenship: Japan  
Inventor's signature:  Date of Signature: 2-27-07  
Residence: (City) San Francisco (State/Country) CA/U.S.  
Address: 248 Amber Drive, San Francisco, CA 94131

Typewritten Full Name of Ninth Inventor: Matthew Dean Rohrbach Citizenship: U.S.  
Inventor's signature:  Date of Signature: 03-27-07  
Residence: (City) San Francisco (State/Country) CA/U.S.  
Address: 29 Ora Way, San Francisco, CA 94131

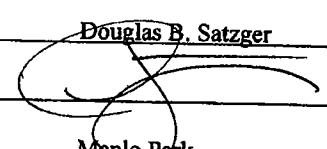
Typewritten Full Name of Tenth Inventor: Douglas B. Satzger Citizenship: U.S.  
Inventor's signature:  Date of Signature: 03-28-07  
Residence: (City) Menlo Park (State/Country) CA/U.S.  
Address: 225 Arden Road, Menlo Park, CA 94025

Typewritten Full Name of Eleventh Inventor: Calvin O. Seid Citizenship: U.S.  
Inventor's signature:  Date of Signature: 2-28-07  
Residence: (City) Palo Alto (State/Country) CA/U.S.  
Address: 1043 High Street, Palo Alto, CA 94301

Typewritten Full Name of Twelfth Inventor: Christopher J. Stringer Citizenship: Australia  
Inventor's signature:  Date of Signature: 2-27-07  
Residence: (City) Portola Valley (State/Country) CA/U.S.  
Address: 320 Cervantes Road, Portola Valley, CA 94028

Typewritten Full Name of Thirteenth Inventor: Eugene Antony Whang Citizenship: Canada  
Inventor's signature:  Date of Signature: 3-27-07  
Residence: (City) San Francisco (State/Country) CA/U.S.  
Address: #1-400 Dolores Street, San Francisco, CA 94114

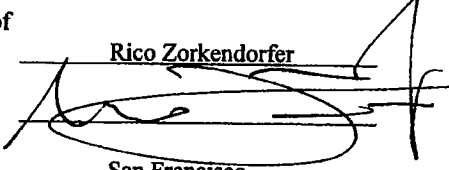
Typewritten Full Name of Fourteenth Inventor: Rico Zorkendorfer Citizenship: Germany  
Inventor's signature:  Date of Signature: 02.27.07  
Residence: (City) San Francisco (State/Country) CA/U.S.  
Address: 327 Lombard Street, San Francisco, CA 94133

# DECLARATION FOR ORIGINAL U.S. PATENT APPLICATION

As a below-named inventor, I hereby declare that:

My residence, post office address and citizenship are as stated below next to my name.

I believe that I am the original, first and joint inventor of the subject matter which is claimed and for which a patent is sought on the invention entitled: ELECTRONIC DEVICE, the specification of which,

- (check one)
1.  is attached hereto.
  2.  was filed on January 5, 2007as  
U.S. Application No. 29/270,888.
  3.  was filed on \_\_\_\_\_ as  
PCT International Application No. \_\_\_\_\_  
and was amended on \_\_\_\_\_.

I hereby state that I have reviewed and understand the contents of the above-identified specification, including the claims, as amended by any amendment referred to above.

I acknowledge the duty to disclose information which is material to patentability as defined in 37 CFR 1.56, including for continuation-in-part applications, material information which became available between the filing date of the prior application and the national or PCT international filing date of the continuation-in-part application.

### Prior Foreign Application(s)

I hereby claim foreign priority benefits under Title 35, United States Code, §119(a)-(d) or (f), or §365(b) of any foreign application for patent or inventor's certificate listed below, or under §365(a) of any PCT international application which designated at least one country other than the United States listed below, and I have identified below, by checking the box, any foreign application for patent or inventor's certificate, or any PCT International application having a filing date before that of the application on which priority is claimed:

			Priority Not Claimed	Cert. Copy Attached
_____	_____	_____	<input type="checkbox"/>	<input type="checkbox"/>
(Application No.)	(Country)	(Filing Date)		
_____	_____	_____	<input type="checkbox"/>	<input type="checkbox"/>
(Application No.)	(Country)	(Filing Date)		

**Direct Correspondence To:**

**Customer Number: 062464**

**Direct Telephone Calls To:**

**Michael J. Ferrazano at telephone number (408) 255-8001**

I hereby declare that all statements made herein of my own knowledge are true and that all statements made on information and belief are believed to be true; and further that these statements were made with the knowledge that willful false statements and the like so made are punishable by fine or imprisonment, or both, under section 1001 of Title 18 of the United States Code, and that such willful false statements may jeopardize the validity of the application or any patent issuing thereon.

Typewritten Full Name of  
First Inventor: Bartley K. Andre Citizenship: U.S.

Inventor's signature: \_\_\_\_\_ Date of Signature: \_\_\_\_\_

Residence: (City) Menlo Park (State/Country) CA/U.S.

Address: 655 Fourteenth Ave., Menlo Park, CA 94025

Typewritten Full Name of  
Second Inventor: Daniel J. Coster Citizenship: New Zealand

Inventor's signature: \_\_\_\_\_ Date of Signature: \_\_\_\_\_

Residence: (City) San Francisco (State/Country) CA/U.S.

Address: 471 14<sup>th</sup> Street, San Francisco, CA 94103

Typewritten Full Name of  
Third Inventor: Daniele De Iuliis Citizenship: IT

Inventor's signature: \_\_\_\_\_ Date of Signature: \_\_\_\_\_

Residence: (City) San Francisco (State/Country) CA/U.S.

Address: 50 Digby Street, San Francisco, CA 94131

Typewritten Full Name of  
Fourth Inventor: Richard P. Howarth Citizenship: Great Britain

Inventor's signature: \_\_\_\_\_ Date of Signature: \_\_\_\_\_

Residence: (City) San Francisco (State/Country) CA/U.S.

Address: 3928 17<sup>th</sup> Street, San Francisco, CA 94114

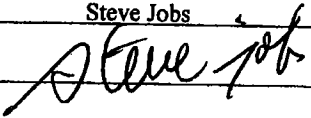

Typewritten Full Name of Fifth Inventor: Jonathan P. Ive Citizenship: Great Britain  
Inventor's signature: \_\_\_\_\_ Date of Signature: \_\_\_\_\_  
Residence: (City) San Francisco (State/Country) CA/U.S.  
Address: 196 Twin Peaks Blvd., San Francisco, CA 94114

Typewritten Full Name of Sixth Inventor: Steve Jobs Citizenship: U.S.  
Inventor's signature:  Date of Signature: 3/13/07  
Residence: (City) Palo Alto (State/Country) CA/U.S.  
Address: 2101 Waverley Street, Palo Alto, CA 94301

Typewritten Full Name of Seventh Inventor: Duncan Robert Kerr Citizenship: Great Britain  
Inventor's signature: \_\_\_\_\_ Date of Signature: \_\_\_\_\_  
Residence: (City) San Francisco (State/Country) CA/U.S.  
Address: 2600 18<sup>th</sup> Street, #15, San Francisco, CA 94110

Typewritten Full Name of Eighth Inventor: Shin Nishibori Citizenship: Japan  
Inventor's signature: \_\_\_\_\_ Date of Signature: \_\_\_\_\_  
Residence: (City) San Francisco (State/Country) CA/U.S.  
Address: 248 Amber Drive, San Francisco, CA 94131

Typewritten Full Name of Ninth Inventor: Matthew Dean Rohrbach Citizenship: U.S.  
Inventor's signature: \_\_\_\_\_ Date of Signature: \_\_\_\_\_  
Residence: (City) San Francisco (State/Country) CA/U.S.  
Address: 29 Ora Way, San Francisco, CA 94131

Typewritten Full Name of Tenth Inventor: Douglas B. Satzger Citizenship: U.S.  
Inventor's signature: \_\_\_\_\_ Date of Signature: \_\_\_\_\_  
Residence: (City) Menlo Park (State/Country) CA/U.S.  
Address: 225 Arden Road, Menlo Park, CA 94025

Typewritten Full Name of  
Eleventh Inventor: Calvin O. Seid Citizenship: U.S.  
Inventor's signature: \_\_\_\_\_ Date of Signature: \_\_\_\_\_  
Residence: (City) Palo Alto (State/Country) CA/U.S.  
Address: 1043 High Street, Palo Alto, CA 94301

Typewritten Full Name of  
Twelfth Inventor: Christopher J. Stringer Citizenship: Australia  
Inventor's signature: \_\_\_\_\_ Date of Signature: \_\_\_\_\_  
Residence: (City) Portola Valley (State/Country) CA/U.S.  
Address: 320 Cervantes Road, Portola Valley, CA 94028

Typewritten Full Name of  
Thirteenth Inventor: Eugene Antony Whang Citizenship: Canada  
Inventor's signature: \_\_\_\_\_ Date of Signature: \_\_\_\_\_  
Residence: (City) San Francisco (State/Country) CA/U.S.  
Address: #1-400 Dolores Street, San Francisco, CA 94114

Typewritten Full Name of  
Fourteenth Inventor: Rico Zorkendorfer Citizenship: Germany  
Inventor's signature: \_\_\_\_\_ Date of Signature: \_\_\_\_\_  
Residence: (City) San Francisco (State/Country) CA/U.S.  
Address: 327 Lombard Street, San Francisco, CA 94133

## Electronic Patent Application Fee Transmittal

<b>Application Number:</b>	
<b>Filing Date:</b>	
<b>Title of Invention:</b>	Electronic Device
<b>First Named Inventor/Applicant Name:</b>	Bartley K. ANDRE
<b>Filer:</b>	Tracy-Gene G. Durkin/Dana Bennett Jackson
<b>Attorney Docket Number:</b>	2607.0590002(P4984USD1)

Filed as Large Entity

### Design Filing Fees

Description	Fee Code	Quantity	Amount	Sub-Total in USD(\$)
<b>Basic Filing:</b>				
Design application filing	1012	1	220	220
Design Search Fee	1112	1	100	100
Design Examination	1312	1	140	140

**Pages:**

**Claims:**

**Miscellaneous-Filing:**

**Petition:**

**Patent-Appeals-and-Interference:**

Description	Fee Code	Quantity	Amount	Sub-Total in USD(\$)
<b>Post-Allowance-and-Post-Issuance:</b>				
<b>Extension-of-Time:</b>				
<b>Miscellaneous:</b>				
<b>Total in USD (\$)</b>				<b>460</b>

## Electronic Acknowledgement Receipt

<b>EFS ID:</b>	4306140
<b>Application Number:</b>	29328018
<b>International Application Number:</b>	
<b>Confirmation Number:</b>	7091
<b>Title of Invention:</b>	Electronic Device
<b>First Named Inventor/Applicant Name:</b>	Bartley K. ANDRE
<b>Customer Number:</b>	63975
<b>Filer:</b>	Tracy-Gene G. Durkin/Dana Bennett Jackson
<b>Filer Authorized By:</b>	Tracy-Gene G. Durkin
<b>Attorney Docket Number:</b>	2607.0590002(P4984USD1)
<b>Receipt Date:</b>	18-NOV-2008
<b>Filing Date:</b>	
<b>Time Stamp:</b>	10:30:21
<b>Application Type:</b>	Design

### Payment information:

Submitted with Payment	yes
Payment Type	Credit Card
Payment was successfully received in RAM	\$460
RAM confirmation Number	6685
Deposit Account	
Authorized User	

### File Listing:

Document Number	Document Description	File Name	File Size(Bytes)/ Message Digest	Multi Part /.zip	Pages (if appl.)
-----------------	----------------------	-----------	----------------------------------	------------------	------------------

1	Miscellaneous Incoming Letter	26070590002cvrltr.pdf	69202 f407bb6b28115073c5608c3d93f054254ab33ef6	no	2
<b>Warnings:</b>					
<b>Information:</b>					
2	Transmittal of New Application	26070590002apptrans.pdf	69460 c3ea09e3b9de98a894c120de501660b88d3de77e	no	1
<b>Warnings:</b>					
<b>Information:</b>					
3	Authorization for Extension of Time all replies	26070590002eotauth.pdf	29738 c9cf6deaa364d3c3672f5785718dd4777dc6a3c8	no	1
<b>Warnings:</b>					
<b>Information:</b>					
4	Application Data Sheet	26070590002ads.pdf	262746 315d8674975e67a6189287f27c0fd8b6cb762b69	no	9
<b>Warnings:</b>					
<b>Information:</b>					
This is not an USPTO supplied ADS fillable form					
5		26090590002specdrw.pdf	422494 21f1063aa369e5284db6af9badcf8fc8429a68f9	yes	12
	<b>Multipart Description/PDF files in .zip description</b>				
	<b>Document Description</b>		<b>Start</b>	<b>End</b>	
	Specification		1	3	
	Claims		4	4	
	Drawings-only black and white line drawings		5	12	
<b>Warnings:</b>					
<b>Information:</b>					
6	Oath or Declaration filed	26070590002dec.pdf	248535 a8108e2029bec3d5073998d9b0e74be43d82898b	no	8
<b>Warnings:</b>					
<b>Information:</b>					
7	Information Disclosure Statement (IDS) Filed (SB/08)	26070590002ids.pdf	343355 a6251d9571661637db22ab77990d8e197f55018c	no	8
<b>Warnings:</b>					
<b>Information:</b>					

This is not an USPTO supplied IDS fillable form

8	Fee Worksheet (PTO-06)	fee-info.pdf	32952 66210ab8ea8ff41970c8a42be18822da0caff 727	no	2
---	------------------------	--------------	---	----	---

**Warnings:**

**Information:**

<b>Total Files Size (in bytes):</b>	1478482
-------------------------------------	---------

**This Acknowledgement Receipt evidences receipt on the noted date by the USPTO of the indicated documents, characterized by the applicant, and including page counts, where applicable. It serves as evidence of receipt similar to a Post Card, as described in MPEP 503.**

**New Applications Under 35 U.S.C. 111**

**If a new application is being filed and the application includes the necessary components for a filing date (see 37 CFR 1.53(b)-(d) and MPEP 506), a Filing Receipt (37 CFR 1.54) will be issued in due course and the date shown on this Acknowledgement Receipt will establish the filing date of the application.**

**National Stage of an International Application under 35 U.S.C. 371**

**If a timely submission to enter the national stage of an international application is compliant with the conditions of 35 U.S.C. 371 and other applicable requirements a Form PCT/DO/EO/903 indicating acceptance of the application as a national stage submission under 35 U.S.C. 371 will be issued in addition to the Filing Receipt, in due course.**

**New International Application Filed with the USPTO as a Receiving Office**

**If a new international application is being filed and the international application includes the necessary components for an international filing date (see PCT Article 11 and MPEP 1810), a Notification of the International Application Number and of the International Filing Date (Form PCT/RO/105) will be issued in due course, subject to prescriptions concerning national security, and the date shown on this Acknowledgement Receipt will establish the international filing date of the application.**

Under the Paperwork Reduction Act of 1995, no persons are required to respond to a collection of information unless it displays a valid OMB control number.

Substitute for form 1449A/PTO				<b>Complete If Known</b>		
<b>INFORMATION DISCLOSURE STATEMENT BY APPLICANT</b>  (Use as many sheets as necessary)				Application Number		To be assigned
				Filing Date		Herewith
				First Named Inventor		ANDRE <i>et al.</i>
				Art Unit		To be assigned
				Examiner Name		To be assigned
				Attorney Docket Number		2607.0590002(P4984USD1)
Sheet	1	of	3			

Examiner Initials*	Cite No. <sup>1</sup>	Document Number	Publication Date MM-DD-YYYY	Name of Patentee or Applicant of Cited Document	Pages, Columns, Lines, Where Relevant Passages or Relevant Figures Appear
		Number-Kind Code <sup>2</sup> (If Known)			
	US1	D289,873	05-19-1987	Gemmell <i>et al.</i>	
	US2	D337,569	07-20-1993	Kando	
	US3	D456,023	04-23-2002	Andre <i>et al.</i>	
	US4	D489,731	05-11-2004	Huang	
	US5	D498,754	11-23-2004	Blyth	
	US6	D499,423	12-07-2004	Bahroocha <i>et al.</i>	
	US7	D502,173	02-22-2005	Jung <i>et al.</i>	
	US8	D504,889	05-10-2005	Andre <i>et al.</i>	
	US9	D505,950	06-07-2005	Summit <i>et al.</i>	
	US10	2005/0130715	06-16-2005	Fujisawa	
	US11	D507,003	07-05-2005	Pai <i>et al.</i>	
	US12	D514,121	01-31-2006	Johnson	
	US13	D514,590	02-07-2006	Naruki	
	US14	D519,523	04-25-2006	Chiu <i>et al.</i>	
	US15	D520,020	05-02-2006	Senda <i>et al.</i>	
	US16	D528,542	09-19-2006	Luminosu <i>et al.</i>	
	US17	D528,561	09-19-2006	Ka-Wei <i>et al.</i>	
	US18	D529,045	09-26-2006	Shin	

FOREIGN PATENT DOCUMENTS						
Examiner Initials*	Cite No. <sup>1</sup>	Foreign Patent Document	Publication Date MM-DD-YYYY	Name of Patentee or Applicant of Cited Document	Pages, Columns, Lines, Where Relevant Passages or Relevant Figures Appear	T <sup>6</sup>
		Country Code <sup>4</sup> Kind Code <sup>5</sup> (in known)				
	FP1	KR 30-0452432	06-14-2007			

Examiner Signature		Date Considered	
--------------------	--	-----------------	--

\*EXAMINER: Initial if reference considered, whether or not citation is in conformance with MPEP 609. Draw line through citation if not in conformance and not considered. Include copy of this form with next communication to applicant. <sup>1</sup>Applicant's unique citation designation number (optional). <sup>2</sup>See Kinds Codes of USPTO Patent Documents at [www.uspto.gov](http://www.uspto.gov) or MPEP 901.04. <sup>3</sup>Enter Office that issued the document, by the two-letter code (WIPO Standard ST.3). <sup>4</sup>For Japanese patent documents, the indication of the year of the reign of the Emperor must precede the serial number of the patent document. <sup>5</sup>Kind of document by the appropriate symbols as indicated on the document under WIPO Standard ST.16 if possible. <sup>6</sup>Applicant is to place a check mark here if English language Translation is attached.  
 This collection of information is required by 37 CFR 1.97 and 1.98. The information is required to obtain or retain a benefit by the public which is to file (and by the USPTO to process) an application. Confidentiality is governed by 35 U.S.C. 122 and 37 CFR 1.14. This collection is estimated to take 2 hours to complete, including gathering, preparing, and submitting the completed application form to the USPTO. Time will vary depending upon the individual case. Any comments on the amount of time you require to complete this form and/or suggestions for reducing this burden, should be sent to the Chief Information Officer, U.S. Patent and Trademark Office, U.S. Department of Commerce, P.O. Box 1450, Alexandria, VA 22313-1450. DO NOT SEND FEES OR COMPLETED FORMS TO THIS ADDRESS. SEND TO: Commissioner for Patents, P.O. Box 1450, Alexandria, VA 22313-1450.



Under the Paperwork Reduction Act of 1995, no persons are required to respond to a collection of information unless it displays a valid OMB control number.

Substitute for form 1449A/PTO				<b>Complete If Known</b>	
<b>INFORMATION DISCLOSURE STATEMENT BY APPLICANT</b>  (Use as many sheets as necessary)				Application Number	To be assigned
				Filing Date	Herewith
				First Named Inventor	ANDRE <i>et al.</i>
				Art Unit	To be assigned
				Examiner Name	To be assigned
				Attorney Docket Number	2607.0590002(P4984USD1)
Sheet	2	of	3		

Examiner Initials*	Cite No. <sup>1</sup>	Document Number	Publication Date MM-DD-YYYY	Name of Patentee or Applicant of Cited Document	Pages, Columns, Lines, Where Relevant Passages or Relevant Figures Appear
		Number-Kind Code <sup>2</sup> (If Known)			
	US19	D532,791	11-28-2006	Kim	
	US20	2006/0281501	12-14-2006	Zuo <i>et al.</i>	
	US21	D534,143	12-26-2006	Lheem	
	US22	D535,281	01-16-2007	Yang	
	US23	D536,691	02-13-2007	Park	
	US24	D538,822	03-20-2007	Andre <i>et al.</i>	
	US25	2007/0082718	04-12-2007	Yoon <i>et al.</i>	
	US26	D541,298	04-24-2007	Andre <i>et al.</i>	
	US27	D541,299	04-24-2007	Andre <i>et al.</i>	
	US28	D546,313	07-10-2007	Lheem	
	US29	D548,747	08-14-2007	Andre <i>et al.</i>	

FOREIGN PATENT DOCUMENTS						
Examiner Initials*	Cite No. <sup>1</sup>	Foreign Patent Document	Publication Date MM-DD-YYYY	Name of Patentee or Applicant of Cited Document	Pages, Columns, Lines, Where Relevant Passages or Relevant Figures Appear	T <sup>6</sup>
		Country Code <sup>3</sup> Kind Code <sup>5</sup> (in known)				

Examiner Signature	Date Considered
--------------------	-----------------

\*EXAMINER: Initial if reference considered, whether or not citation is in conformance with MPEP 609. Draw line through citation if not in conformance and not considered. Include copy of this form with next communication to applicant. <sup>1</sup>Applicant's unique citation designation number (optional). <sup>2</sup>See Kinds Codes of USPTO Patent Documents at [www.uspto.gov](http://www.uspto.gov) or MPEP 901.04. <sup>3</sup>Enter Office that issued the document, by the two-letter code (WIPO Standard ST.3). <sup>4</sup>For Japanese patent documents, the indication of the year of the reign of the Emperor must precede the serial number of the patent document. <sup>5</sup>Kind of document by the appropriate symbols as indicated on the document under WIPO Standard ST.16 if possible. <sup>6</sup>Applicant is to place a check mark here if English language Translation is attached.

This collection of information is required by 37 CFR 1.97 and 1.98. The information is required to obtain or retain a benefit by the public which is to file (and by the USPTO to process) an application. Confidentiality is governed by 35 U.S.C. 122 and 37 CFR 1.14. This collection is estimated to take 2 hours to complete, including gathering, preparing, and submitting the completed application form to the USPTO. Time will vary depending upon the individual case. Any comments on the amount of time you require to complete this form and/or suggestions for reducing this burden, should be sent to the Chief Information Officer, U.S. Patent and Trademark Office, U.S. Department of Commerce, P.O. Box 1450, Alexandria, VA 22313-1450. DO NOT SEND FEES OR COMPLETED FORMS TO THIS ADDRESS. SEND TO: Commissioner for Patents, P.O. Box 1450, Alexandria, VA 22313-1450.

If you need assistance in completing the form, call 1-800-PTO-9199 and select option 2.

Under the Paperwork Reduction Act of 1995, no persons are required to respond to a collection of information unless it displays a valid OMB control number.

Substitute for form 1449B/PTO  <b>INFORMATION DISCLOSURE STATEMENT BY APPLICANT</b>  (Use as many sheets as necessary)			<b>Complete If Known</b>		
			Application Number	To be assigned	
			Filing Date	Herewith	
			First Named Inventor	ANDRE <i>et al.</i>	
			Art Unit	To be assigned	
			Examiner Name	To be assigned	
Sheet	3	of	3	Attorney Docket Number	2607.0590002(P4984USD1)

NON PATENT LITERATURE DOCUMENTS			
Examiner Initials*	Cite No. <sup>1</sup>	Include name of the author (in CAPITAL LETTERS), title of the article (when appropriate), title of the item (book, magazine, journal, serial, symposium, catalog, etc.), date page(s), volume-issue number(s), publisher, city and/or country where published	T <sup>2</sup>
	NPL1	Samsung F700, announced February 2007, [online], [retrieved on 02-08-07]. Retrieved from Internet ,<URL:http://www.gsmarena.com>	
	NPL2	Philips S900, announced June 2006, [online], [retrieved on 02-20-07]. Retrieved from Internet ,<URL:http://www.gsmarena.com>	
	NPL3	LG KE850 Prada, announced January 2007, [online], [retrieved on 02-20-07]. Retrieved from Internet ,<URL:http://www.gsmarena.com>	
	NPL4	Apple iPhone, announced January 2007, [online], [retrieved on 03-12-07]. Retrieved from Internet ,<URL:http://www.gsmarena.com>	
	NPL5	Tinnos PDA, posted May 19, 2006, [online], [retrieved on 08-22-07]. Retrieved from Internet ,<URL:http://www.mobilewhack.com>	
	NPL6	Meizu M8, posted January, 29, 2007, [online], [retrieved on 09-13-07]. Retrieved from Internet ,<URL:http://www.engadget.com>	
	NPL7	U.S. Appl. No. 29/284,271, Andre et al., Electronic Device, filed 09-04-2007.	
	NPL8	U.S. Appl. No. 29/284,312, Andre et al., Electronic Device, filed 09-05-2007.	
	NPL9	U.S. Appl. No. 29/319,377, Andre et al., Electronic Device, filed 06-06-2008.	

Examiner Signature		Date Considered	
--------------------	--	-----------------	--

\*EXAMINER: Initial if reference considered, whether or not citation is in conformance with MPEP 609. Draw line through citation if not in conformance and not considered. Include copy of this form with next communication to applicant.

<sup>1</sup>Applicant's unique citation designation number (optional). <sup>2</sup> Applicant is to place a check mark here if English language Translation is attached.

This collection of information is required by 37 CFR 1.97 and 1.98. The information is required to obtain or retain a benefit by the public which is to file (and by the USPTO to process) an application. Confidentiality is governed by 35 U.S.C. 122 and 37 CFR 1.14. This collection is estimated to take 2 hours to complete, including gathering, preparing, and submitting the completed application form to the USPTO. Time will vary depending upon the individual case. Any comments on the amount of time you require to complete this form and/or suggestions for reducing this burden, should be sent to the Chief Information Officer, U.S. Patent and Trademark Office, U.S. Department of Commerce, P.O. Box 1450, Alexandria, VA 22313-1450. DO NOT SEND FEES OR COMPLETED FORMS TO THIS ADDRESS. SEND TO: Commissioner for Patents, P.O. Box 1450, Alexandria, VA 22313-1450.

If you need assistance in completing the form, call 1-800-PTO-9199 and select option 2.



Robert Greene Sterne  
Jorge A. Goldstein  
David K.S. Cornwell  
Robert W. Esmond  
Tracy-Gene G. Durkin  
Michele A. Cimbala  
Michael B. Ray  
Robert E. Sokohl  
Eric K. Steffe  
Michael Q. Lee  
John M. Covert  
Robert C. Millonig  
Donald J. Featherstone  
Timothy J. Shea, Jr  
Michael V. Messenger  
Judith U. Kim  
Jeffrey T. Helvey  
Eldora L. Ellison  
Donald R. Banowitz

Peter A. Jackman  
Brian J. Del Buono  
Mark Fox Evens  
Vincent L. Capuano  
Elizabeth J. Haanes  
Michael D. Specht  
Kevin W. McCabe  
Glenn J. Perry  
Theodore A. Wood  
Edward W. Yee  
Grant E. Reed  
Jason D. Eisenberg  
Tracy L. Muller  
Jon E. Wright  
LuAnne M. DeSantis  
Helene C. Carlson  
Cynthia M. Bouchez  
Timothy A. Doyle  
Gaby L. Longworth

Lori A. Gordon  
Laura A. Vogel  
Shannon A. Carroll  
Anbar F. Khal  
Michelle K. Holoubek  
Marsha A. Rose  
Scott A. Schaller  
Lei Zhou  
W. Blake Coblentz  
James J. Pohl  
John T. Haran  
Mark W. Rygiel  
Michael R. Malek\*  
Carla Ji-Eun Kim  
Doyle A. Siever\*  
Ulrike Winkler Jenks  
Paul A. Calvo  
C. Matthew Rozier\*  
Randall K. Baldwin

Daniel J. Nevivy  
Lori M. Brandes  
Jeffrey K. Mills\*  
Mita Mukherjee\*  
Scott M. Woodhouse\*  
Christian A. Camarce\*  
Richard D. Collier III\*  
Keisha Hylton-Rodic  
Bonnie Nannenga-Combs  
Alyssa K. Sandrowitz\*  
Jonathan M. Strang\*  
Ishan P. Weerakoon\*  
  
Registered Patent Agents\*  
Karen R. Markowicz  
Matthew J. Dowd  
Peter A. Socarras  
Danielle L. Letting  
Steven C. Oppenheimer

Aaron S. Lukas  
Gaurav Asthana  
Stephanie L. Elmer  
Robert E. Bakin  
Salvador M. Bezos  
Yasser Mountada

Of Counsel  
Edward J. Kessler  
Kenneth C. Bass III  
Marvin C. Guthrie  
Christopher P. Wrist  
David C. Isaacson

\* Admitted only in Maryland  
\* Admitted only in Virginia  
\* Practice Limited to  
Federal Agencies

November 18, 2008

*WRITER'S DIRECT NUMBER:*  
(202) 772-8660  
*INTERNET ADDRESS:*  
TDURKIN@SKGF.COM

Commissioner for Patents  
PO Box 1450  
Alexandria, VA 22313-1450

Re: U.S. Design Patent Application  
(*Divisional of Appl. No. 29/282,834; Filed July 30, 2007*)  
Appl. No. *To be assigned*; Filed: November 14, 2008  
For: **Electronic Device**  
Inventors: ANDRE *et al.*  
Our Ref: 2607.0590002(P4984USD1)/TGD/AKS

Sir:

The following documents are transmitted herewith for appropriate action by the U.S. Patent and Trademark Office:

1. Design Patent Application Transmittal Form (PTO/SB/18);
2. Online Credit Card Payment Authorization for \$460.00 to cover basic filing, search, and examination fees;
3. Authorization to Treat a Reply as Incorporating an Extension of Time Under 37 C.F.R. § 1.136(a)(3);
4. U.S. Design Patent Application entitled:

**Electronic Device**

and naming as inventors:

Bartley K. ANDRE  
Daniel J. COSTER  
Daniele DE IULIIS  
Richard P. HOWARTH  
Jonathan P. IVE  
Steve JOBS

Duncan Robert KERR  
Shin NISHIBORI  
Matthew Dean ROHRBACH  
Douglas B. SATZGER  
Calvin Q. SEID  
Christopher J. STRINGER  
Eugene Antony WHANG  
Rico ZORKENDORFER

the application consisting of:

- a. an Application Data Sheet (37 C.F.R. § 1.76);
  - b. 4 pages of textual specification including one claim;
  - c. 8 sheets of formal drawings comprising Figures 1-32; and
  - d. A copy of the executed Declaration, as filed in U.S. Appl. No. 29/282,834;
5. An Information Disclosure Statement (IDS);
  6. IDS Forms (3 pages) citing documents US1-US29, FP1 and NPL1-NPL9.

The above-listed documents are filed electronically through EFS-Web.

Fee payment is provided through online credit card payment. The U.S. Patent and Trademark Office is hereby authorized to charge any fee deficiency, or credit any overpayment, to our Deposit Account No. 19-0036.

Respectfully submitted,

STERNE, KESSLER, GOLDSTEIN & FOX P.L.L.C.



Tracy-Geoff G. Durkin  
Attorney for Applicants  
Registration No. 32,831

TGD/AKS:dbj  
Enclosures

902171\_1.DOC

IN THE UNITED STATES PATENT AND TRADEMARK OFFICE

In re application of:

ANDRE *et al.*

Appl. No.: *To be assigned (Divisional of U.S.  
Appl. No. 29/282,834; Filed: July 30, 2007)*

Filed: *Herewith*

For: **Electronic Device**

Confirmation No.: *To be assigned*

Art Unit: *To be assigned*

Examiner: *To be assigned*

Atty. Docket:  
2607.0590002(P4984USD1)/TGD/AKS

**Information Disclosure Statement**

***Mail Stop Amendment***

Commissioner for Patents  
PO Box 1450  
Alexandria, VA 22313-1450

Sir:

Listed on accompanying IDS Forms are documents that may be considered material to the patentability of this application as defined in 37 C.F.R. §1.56, and in compliance with the duty of disclosure requirements of 37 C.F.R. §§ 1.97 and 1.98.

Where the publication date of a listed document does not provide a month of publication, the year of publication of the listed document is sufficiently earlier than the effective U.S. filing date and any foreign priority date so that the month of publication is not in issue. Applicants have listed publication dates on the attached IDS Forms based on information presently available to the undersigned. However, the listed publication dates should not be construed as an admission that the information was actually published on the date indicated.

Applicants reserve the right to establish the patentability of the claimed invention over any of the information provided herewith, and/or to prove that this information may not be prior art, and/or to prove that this information may not be enabling for the teachings purportedly offered.

This statement should not be construed as a representation that a search has been made, or that information more material to the examination of the present patent application does not exist. The Examiner is specifically requested not to rely solely on the material submitted herewith.

Applicants have checked the appropriate boxes below.

- 1. Statement under 37 C.F.R. 1.704(d). Each item of information contained in this Information Disclosure Statement was first cited in a communication from a foreign patent office in a counterpart application and this communication was not received by any individual designated in 37 C.F.R. § 1.56(c) more than thirty days prior to the filing of this information disclosure statement.
- 2. Filing under 37 C.F.R. § 1.97(b). This Information Disclosure Statement is being filed within three months of the date of filing of a national application other than a continued prosecution application (CPA), OR within three months of the date of entry of the national stage as set forth in 37 C.F.R. § 1.491 in an international application, OR before the mailing date of a first Office Action on the merits OR before the mailing of a first Office Action after the filing of a request for continued examination under 37 C.F.R. § 1.114. No statement or fee is required.
- 3. Filing under 37 C.F.R. § 1.97(c). This Information Disclosure Statement is being filed more than three months after the U.S. filing date AND after the mailing date of the first Office Action on the merits, but before the mailing date of a Final Rejection, or Notice of Allowance, or an action that otherwise closes prosecution in the application.

- a. Statement under 37 C.F.R. § 1.97(e)(1). I hereby state that each item of information contained in this Information Disclosure Statement was first cited in any communication from a foreign patent office in a counterpart foreign application not more than three months prior to the filing of this Information Disclosure Statement. 37 C.F.R. § 1.97(e)(1).
- b. Statement under 37 C.F.R. § 1.97(e)(2). I hereby state that no item of information in this Information Disclosure Statement was cited in a communication from a foreign patent office in a counterpart foreign application and, to my knowledge after making reasonable inquiry, was known to any individual designated in 37 C.F.R. § 1.56(c) more than three months prior to the filing of this Information Disclosure Statement. 37 C.F.R. § 1.97(e)(2).
- c. Attached is our PTO-2038 Credit Card Payment Form in the amount of \$\_\_\_\_\_ in payment of the fee under 37 C.F.R. § 1.17(p).
4. Filing under 37 C.F.R. § 1.97(d) This Information Disclosure Statement is being filed more than three months after the U.S. filing date and after the mailing date of a Final Rejection or Notice of Allowance, but on or before payment of the Issue Fee. Enclosed find our PTO-2038 Credit Card Payment Form in the amount of \$\_\_\_\_\_ in payment of the fee under 37 C.F.R. § 1.17(p); in addition:
- a. Statement under 37 C.F.R. § 1.97(e)(1). I hereby state that each item of information contained in this Information Disclosure

Statement was first cited in any communication from a foreign patent office in a counterpart foreign application not more than three months prior to the filing of this Information Disclosure Statement. 37 C.F.R. § 1.97(e)(1).

- b. Statement under 37 C.F.R. § 1.97(e)(2). I hereby state that no item of information in this Information Disclosure Statement was cited in a communication from a foreign patent office in a counterpart foreign application and, to my knowledge after making reasonable inquiry, was known to any individual designated in 37 C.F.R. § 1.56(c) more than three months prior to the filing of this Information Disclosure Statement. 37 C.F.R. § 1.97(e)(2).
5. The document(s) was/were cited in a search report by a foreign patent office in a counterpart foreign application. Submission of an English language version of the search report that indicates the degree of relevance found by the foreign office is provided in satisfaction of the requirement for a concise explanation of relevance. 1138 OG 37, 38.
6. A concise explanation of the relevance of the non-English language document(s) appears below in accordance with 37 C.F.R. § 1.98(a)(3).
7. In accordance with 37 C.F.R. § 1.98(a)(2), no copies of U.S. patents and patent application publications cited on the attached IDS Forms are submitted. Further, NPL7-NPL9 are believed to be stored on the Image File Wrapper System. Thus, copies of these documents are not attached. MPEP 1406; 1287 O.G. 163 (Oct. 19, 2004).



8. Copies of the documents FP1 and NPL1-NPL6 were cited by or submitted to the Office in an IDS that complies with 37 C.F.R. § 1.98(a)-(c) in Application No. 29/282,834, filed July 30, 2007, which is relied upon for an earlier filing date under 35 U.S.C. § 120. Thus, copies of these documents are not attached. 37 C.F.R. § 1.98(d).
9. It is expected that the examiner will review the prosecution and cited art in the parent application nos. 29/282,834, filed July 30, 2007 and 29/270,888, filed January 5, 2007 in accordance with MPEP 2001.06(b), and indicate in the next communication from the office that the art cited in the earlier prosecution history has been reviewed in connection with the present application.

It is respectfully requested that the Examiner initial and return a copy of the enclosed IDS Forms, and indicate in the official file wrapper of this patent application that the documents have been considered.

The U.S. Patent and Trademark Office is hereby authorized to charge any fee deficiency, or credit any overpayment, to our Deposit Account No. 19-0036.

Respectfully submitted,

STERNE, KESSLER, GOLDSTEIN & FOX P.L.L.C.



Tracy-Gen G. Durkin  
Attorney for Applicants  
Registration No. 32,831

Date: November 18, 2008

1100 New York Avenue, N.W.  
Washington, D.C. 20005-3934  
(202) 371-2600

902143\_1.DOC

Atty. Dkt. No. 2607.0590002(P4984USD1)/TGD/AKS



UNITED STATES PATENT AND TRADEMARK OFFICE

UNITED STATES DEPARTMENT OF COMMERCE
United States Patent and Trademark Office
Address: COMMISSIONER FOR PATENTS
P.O. Box 1450
Alexandria, Virginia 22313-1450
www.uspto.gov

Table with 6 columns: APPLICATION NUMBER, FILING or 371(c) DATE, GRP ART UNIT, FIL FEE REC'D, ATTY.DOCKET.NO, TOT CLAIMS, IND CLAIMS. Row 1: 29/328,018, 11/18/2008, 2913, 460, 2607.0590002(P4984USD1)/T, 1, 1

CONFIRMATION NO. 7091

FILING RECEIPT

63975
STERNE KESSLER GOLDSTEIN & FOX P.L.L.C.
1100 NEW YORK AVENUE, N.W.
WASHINGTON, DC 20005



Date Mailed: 11/28/2008

Receipt is acknowledged of this non-provisional patent application. The application will be taken up for examination in due course. Applicant will be notified as to the results of the examination. Any correspondence concerning the application must include the following identification information: the U.S. APPLICATION NUMBER, FILING DATE, NAME OF APPLICANT, and TITLE OF INVENTION. Fees transmitted by check or draft are subject to collection. Please verify the accuracy of the data presented on this receipt. If an error is noted on this Filing Receipt, please submit a written request for a Filing Receipt Correction. Please provide a copy of this Filing Receipt with the changes noted thereon. If you received a "Notice to File Missing Parts" for this application, please submit any corrections to this Filing Receipt with your reply to the Notice. When the USPTO processes the reply to the Notice, the USPTO will generate another Filing Receipt incorporating the requested corrections

Applicant(s)

- Bartley K. ANDRE, Menlo Park, CA;
Daniel J. Coster, San Francisco, CA;
Daniele De Iuliis, San Francisco, CA;
Richard P. Howarth, San Francisco, CA;
Jonathan P. Ive, San Francisco, CA;
Steve Jobs, Palo Alto, CA;
Duncan Robert Kerr, San Francisco, CA;
Shin Nishibori, Portola Valley, CA;
Matthew Dean Rohrbach, San Francisco, CA;
Douglas B. Satzger, Menlo Park, CA;
Calvin Q. Seid, Palo Alto, CA, Deceased;
Christopher J. Stringer, Woodside, CA;
Eugene Anthony Whang, San Francisco, CA;
Rico Zorkendorfer, San Francisco, CA;

Power of Attorney: None

Domestic Priority data as claimed by applicant

This application is a DIV of 29/282,834 07/30/2007 PAT D,581,922
which is a CON of 29/270,888 01/05/2007 PAT D,558,758

Foreign Applications

If Required, Foreign Filing License Granted: 11/26/2008

The country code and number of your priority application, to be used for filing abroad under the Paris Convention, is **US 29/328,018**

**Projected Publication Date:** None, application is not eligible for pre-grant publication

**Non-Publication Request:** No

**Early Publication Request:** No  
**Title**

Electronic Device

**Preliminary Class**

D14

## **PROTECTING YOUR INVENTION OUTSIDE THE UNITED STATES**

Since the rights granted by a U.S. patent extend only throughout the territory of the United States and have no effect in a foreign country, an inventor who wishes patent protection in another country must apply for a patent in a specific country or in regional patent offices. Applicants may wish to consider the filing of an international application under the Patent Cooperation Treaty (PCT). An international (PCT) application generally has the same effect as a regular national patent application in each PCT-member country. The PCT process **simplifies** the filing of patent applications on the same invention in member countries, but **does not result** in a grant of "an international patent" and does not eliminate the need of applicants to file additional documents and fees in countries where patent protection is desired.

Almost every country has its own patent law, and a person desiring a patent in a particular country must make an application for patent in that country in accordance with its particular laws. Since the laws of many countries differ in various respects from the patent law of the United States, applicants are advised to seek guidance from specific foreign countries to ensure that patent rights are not lost prematurely.

Applicants also are advised that in the case of inventions made in the United States, the Director of the USPTO must issue a license before applicants can apply for a patent in a foreign country. The filing of a U.S. patent application serves as a request for a foreign filing license. The application's filing receipt contains further information and guidance as to the status of applicant's license for foreign filing.

Applicants may wish to consult the USPTO booklet, "General Information Concerning Patents" (specifically, the section entitled "Treaties and Foreign Patents") for more information on timeframes and deadlines for filing foreign patent applications. The guide is available either by contacting the USPTO Contact Center at 800-786-9199, or it can be viewed on the USPTO website at <http://www.uspto.gov/web/offices/pac/doc/general/index.html>.

For information on preventing theft of your intellectual property (patents, trademarks and copyrights), you may wish to consult the U.S. Government website, <http://www.stopfakes.gov>. Part of a Department of Commerce initiative, this website includes self-help "toolkits" giving innovators guidance on how to protect intellectual property in specific countries such as China, Korea and Mexico. For questions regarding patent enforcement issues, applicants may call the U.S. Government hotline at 1-866-999-HALT (1-866-999-4158).

**LICENSE FOR FOREIGN FILING UNDER**  
**Title 35, United States Code, Section 184**  
**Title 37, Code of Federal Regulations, 5.11 & 5.15**

**GRANTED**

The applicant has been granted a license under 35 U.S.C. 184, if the phrase "IF REQUIRED, FOREIGN FILING LICENSE GRANTED" followed by a date appears on this form. Such licenses are issued in all applications where the conditions for issuance of a license have been met, regardless of whether or not a license may be required as set forth in 37 CFR 5.15. The scope and limitations of this license are set forth in 37 CFR 5.15(a) unless an earlier license has been issued under 37 CFR 5.15(b). The license is subject to revocation upon written notification. The date indicated is the effective date of the license, unless an earlier license of similar scope has been granted under 37 CFR 5.13 or 5.14.

This license is to be retained by the licensee and may be used at any time on or after the effective date thereof unless it is revoked. This license is automatically transferred to any related applications(s) filed under 37 CFR 1.53(d). This license is not retroactive.

The grant of a license does not in any way lessen the responsibility of a licensee for the security of the subject matter as imposed by any Government contract or the provisions of existing laws relating to espionage and the national security or the export of technical data. Licensees should apprise themselves of current regulations especially with respect to certain countries, of other agencies, particularly the Office of Defense Trade Controls, Department of State (with respect to Arms, Munitions and Implements of War (22 CFR 121-128)); the Bureau of Industry and Security, Department of Commerce (15 CFR parts 730-774); the Office of Foreign Assets Control, Department of Treasury (31 CFR Parts 500+) and the Department of Energy.

**NOT GRANTED**

No license under 35 U.S.C. 184 has been granted at this time, if the phrase "IF REQUIRED, FOREIGN FILING LICENSE GRANTED" DOES NOT appear on this form. Applicant may still petition for a license under 37 CFR 5.12, if a license is desired before the expiration of 6 months from the filing date of the application. If 6 months has lapsed from the filing date of this application and the licensee has not received any indication of a secrecy order under 35 U.S.C. 181, the licensee may foreign file the application pursuant to 37 CFR 5.15(b).

**HILON** 海龙资讯 | 首页 | 行情促销 | 新闻中心 | 报价中心 | 评测中心 | DC/DV | MP3/MP4 | 笔记本 | 硬件频道  
 摄影会 | 歌友会 | 论坛 | 海龙电子地图 | 网上投诉 | 海龙维修中心 | 海龙采风

## 黑白猜 LG新颖DMB MP3 FM35精美图赏

时间： 2006-06-29 作者： 来源： 海龙资讯

第1页：纯白演艺

对于LG的新品DMB MP3——FM35，我们以前早有报道：DMB战火愈演愈烈 LG新推FM35、MP3+DMB LG FM35，而今天要给大家展示的是韩国网站pmpinside和minivian为FM35拍摄的精美图片，很凑巧的是这两个网站拍摄的分别是一黑一白两款机器，倒是更加充分的展示FM35的魅力所在。

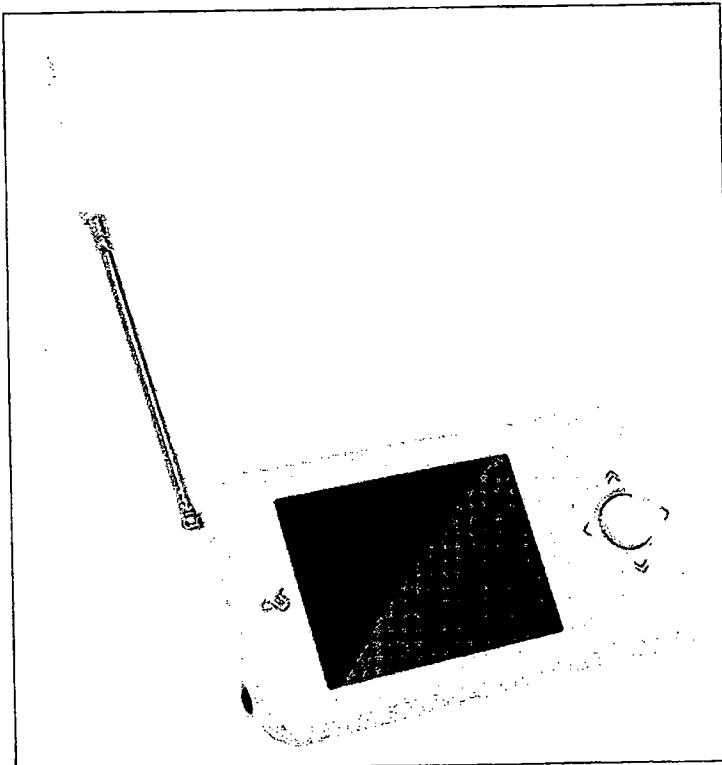

### 最新文章 New

- 神舟疾速X700独显 承天 W280A降1000
- IBM T60售价35000元 送429元电子鱼
- 大降500元 三星R50-CV04售9688元!
- 炎夏送清凉 理光巧克力冰淇淋版上市
- S3000高配版也便宜 NEC白色本11988
- 学生机杀手 三星C1 256M容量小降60元

### 5月10日 TOP10

- ▶ 和512M容量MP3说再见! LG彩屏MP3导购
- ▶ 炎热挡不住 夏日狂降笔记本分享篇
- ▶ iPod video疯狂降价! 30G容量仅售2580
- ▶ MP4变PSP! JXD683 游戏MP4仅售750元
- ▶ 告别熬夜看世界杯! 彩屏MP3、MP4导购
- ▶ 不用锻炼臂力 家用长焦防抖相机选购

### -- 论坛热贴 --

- 教你如何刻录极品CD音乐碟
- DIY牛人自制MM机箱 男士至爱
- K8 超频完整教学
- 笔记本维修也分三六九等
- DELL30英寸LCD 3007WFP
- 939 Opteron明年继续出货









责任编辑:高靖宇

第一页 1 2 3 4 5 6 7 8 9 最后页

**Kodak 柯达 V570**  **RETINA双镜头技术** **加399元即送**  
**23毫米超广角** **柯达3系相片打印机**  
**5倍光学变焦** **¥2599元** 

相关文章

- 我是双芯的! DEC C150 512MB仅售399元( 2006-06-29)
- 天籁之音 OPPO X17K 256M仅售499元( 2006-06-29)
- 明基暑假忙! 买DA102送精美挂链一条( 2006-06-29)
- 学生机杀手 三星C1 256M容量小降60元( 2006-06-29)
- 炎夏送清凉 理光巧克力冰淇淋版上市( 2006-06-29)
- 宏基高端商务机 TM8204 惊爆降价中( 2006-06-29)
- 神舟疾速X700独显 承运W280A降1000( 2006-06-29)
- S3000高配版也便宜 NEC白色本11988( 2006-06-29)
- IBM T60售价35000元 送429元电子鱼( 2006-06-29)
- 宏基高端系列Aspire 5672跌破12000( 2006-06-29)

用户名:  匿名  申请新用户

密码: \_\_\_\_\_

内容: \_\_\_\_\_

[查看最新评论](#)

网站合作、内容监督、商务咨询电话: 010-82660133  
 海龙资讯网所有文章和图片版权所有, 禁止一切非授权的转载和抄袭行为  
 网站经营许可证编号: \*京ICP证050702号



**HILON** 海龙资讯

[首页](#) | [行情促销](#) | [新闻中心](#) | [报价中心](#) | [评测中心](#) | [DC/DV](#) | [MP3/MP4](#) | [笔记本](#) | [硬件频道](#)  
[爱摄会](#) | [歌友会](#) | [论坛](#) | [海龙电子地图](#) | [网上投诉](#) | [海龙维修中心](#) | [海龙采风](#)

搜索

## 黑白猜 LG新颖DMB MP3 FM35精美图赏

时间： 2006-06-29 作者： 来源： 海龙资讯

第2页： 嫩绿心情



### 最新文章 New

- 神舟疾速X700独显 承运 W280A降1000
- IBM T60售价35000元 送429元电子鱼
- 大降500元 三星R50-CV04售9688元!
- 炎夏送清凉 理光巧克力冰淇淋版上市
- S3000高配版也便宜 NEC白色本11988
- 学生机杀手 三星C1 256M容量小降60元

### 本月之星 TOP10

- ▶ 和512M容量MP3说再见! 1G彩屏MP3导购
- ▶ 炎热挡不住 夏日狂降笔记本分享篇
- ▶ iPod video疯狂降价! 30G容量仅售2580
- ▶ MP4变PSP! JXD683 游戏MP4仅售750元
- ▶ 告别熬夜看世界杯! 彩屏MP3、MP4导购
- ▶ 不用锻炼臂力 家用长焦防抖相机选购

### -- 论坛热点 --

- 教你如何刻录极品CD音乐碟
- DIY牛人自制MM机箱 男士至爱
- K8 超频完整教学
- 笔记本维修也分三六九等
- DELL.30英寸LCD 3007WFP
- 939 Opteron明年继续出货





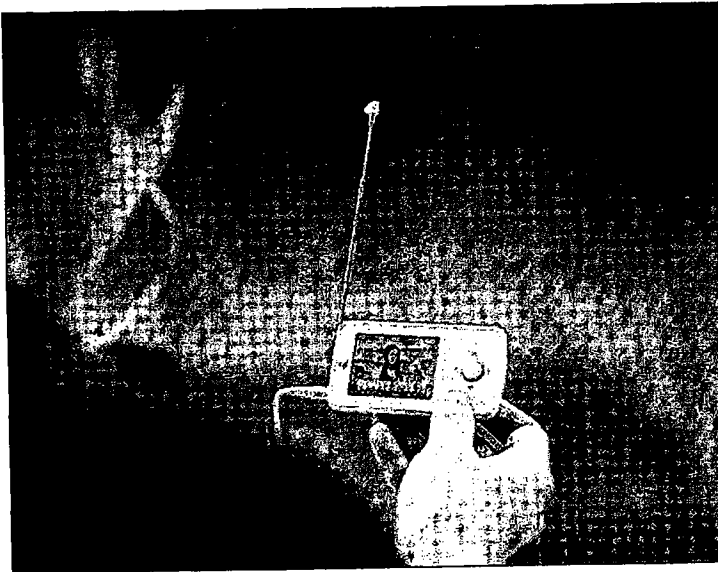
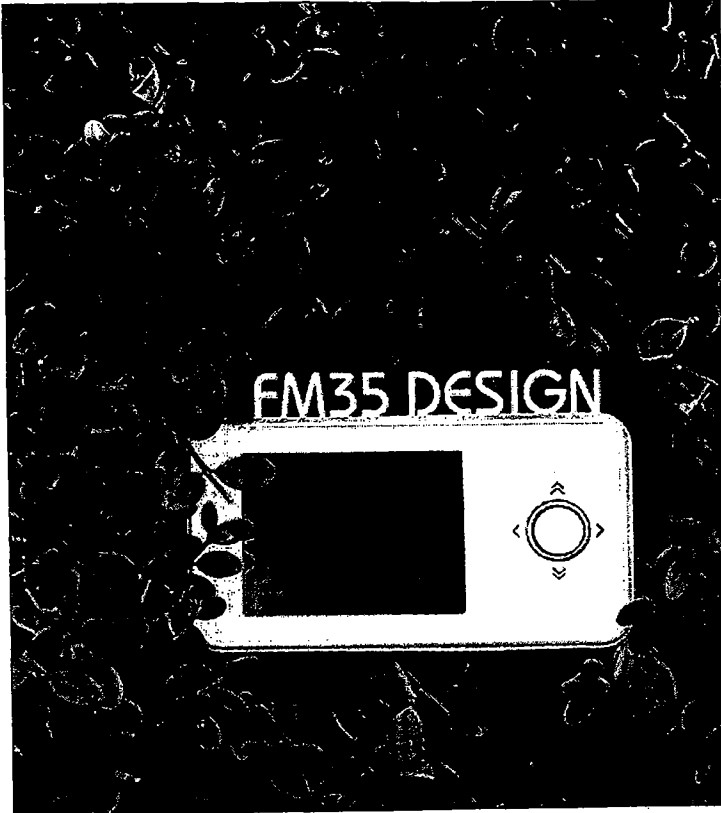

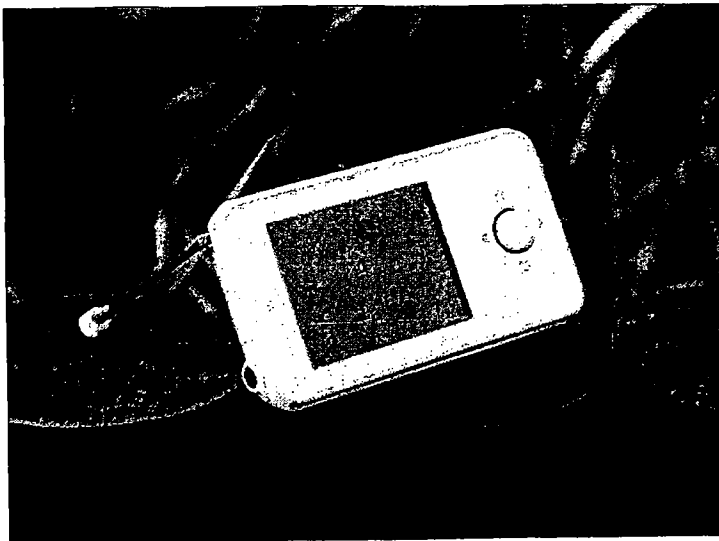



责任编辑：高靖宇

第一页 1 2 3 4 5 6 7 8 9 最后页

**Kodak 柯达 V570**  **RETINA双镜头技术 23毫米超广角 5倍光学变焦** **加399元即送 柯达3系相片打印机** **2599元** 

相关文章:

- 我是双芯的! DEC C150 512MB仅399元(2006-06-29)
- 天籁之音 OPPO X17K 256M仅售499元(2006-06-29)
- 明基暑假忙! 买DA102送精美挂链一条(2006-06-29)
- 学生机杀手 三星CI 256M容量小降60元(2006-06-29)
- 炎夏送清凉 理光巧克力冰淇淋版上市(2006-06-29)
- 宏基高端商务机 TM8204 惊爆降价中(2006-06-29)
- 神舟疾速X700独显 承运W280A降1000(2006-06-29)
- S3000高配版也便宜 NEC白色本11988(2006-06-29)
- TBM T60售价35000元 送429元电子鱼(2006-06-29)
- 宏基高端系列Aspire 5672跌破12000(2006-06-29)

网友评论:

用户名:  匿名  申请新用户

密码: \_\_\_\_\_

内容: \_\_\_\_\_

[查看最新评论](#)

网站合作、内容监督、商务咨询电话: 010-82660133  
 海龙资讯网所有文章和图片版权所有, 禁止一切非授权的转载和抄袭行为  
 网站经营许可证编号: \*京ICP证050702号



**HILON** 海龙资讯 | 首页 | 行情促销 | 新闻中心 | 报价中心 | 评测中心 | 闪存 | MP3/MP4 | 笔记本 | 硬件频道  
 爱摄会 | 歌友会 | 论坛 | 海龙电子地图 | 网上投诉 | 海龙维修中心 | 海龙采风  **搜索**

# 黑白猜 LG新颖DMB MP3 FM35精美图赏

时间：2006-06-29 作者：来源：海龙资讯

第3页：黑色基调

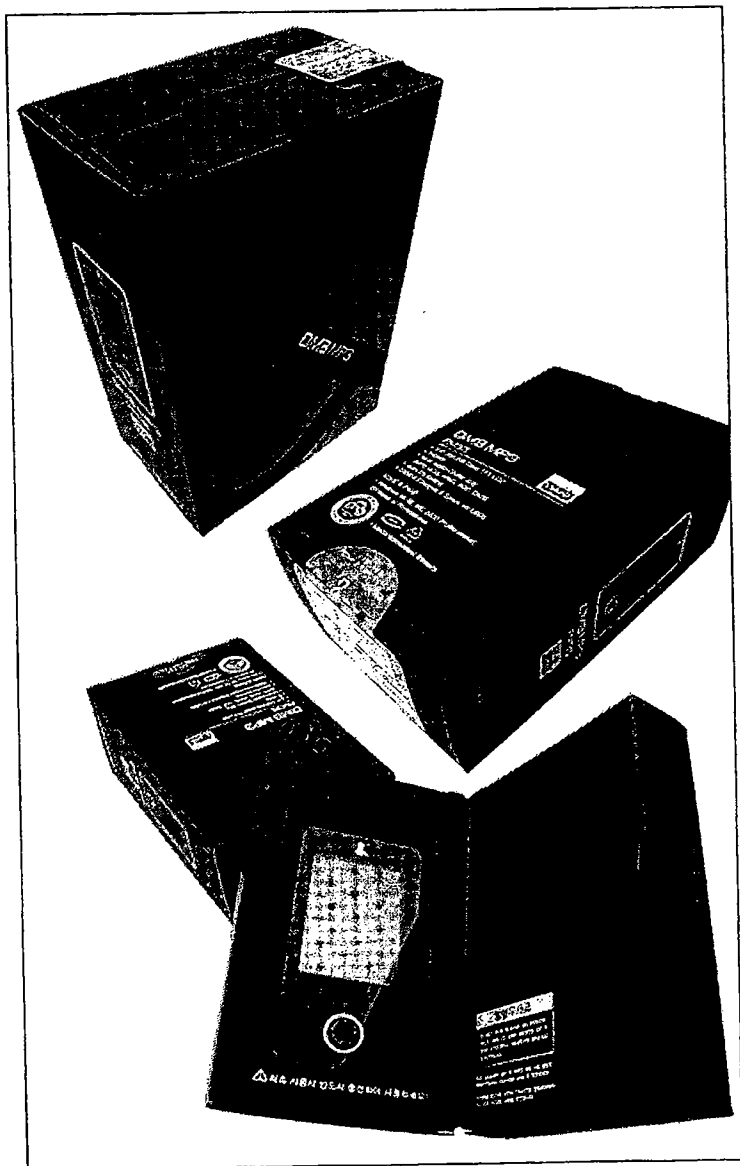

### 最新文章 New

- 神舟疾速X700独显 承运 W280A降1000
- IBM T60售价35000元 送429元电子鱼
- 大降500元 三星R50-CV04售9688元!
- 炎夏送清凉 理光巧克力冰淇淋版上市
- S3000高配版也便宜 NEC白色本11988
- 学生机杀手 三星C1 256M容量小降60元

### 本月文章TOP1

- ▶ 和512M容量MP3说再见! 1G彩屏MP3导购
- ▶ 炎热挡不住 夏日狂降笔记本分享篇
- ▶ iPod video疯狂降价! 30G容量仅售2580
- ▶ MP4变PSP! JXD683 游戏MP4仅售750元
- ▶ 告别熬夜看世界杯! 彩屏MP3、MP4导购
- ▶ 不用锻炼臂力 家用长焦防抖相机选购

### -- 论坛热贴 --

- 教你如何刻录极品CD音乐碟
- DIY牛人自制MM机箱 男士至爱
- K8 超频完整教学
- 笔记本维修也分三六九等
- DELL30英寸LCD 3007WFP
- 939 Opteron明年继续出货



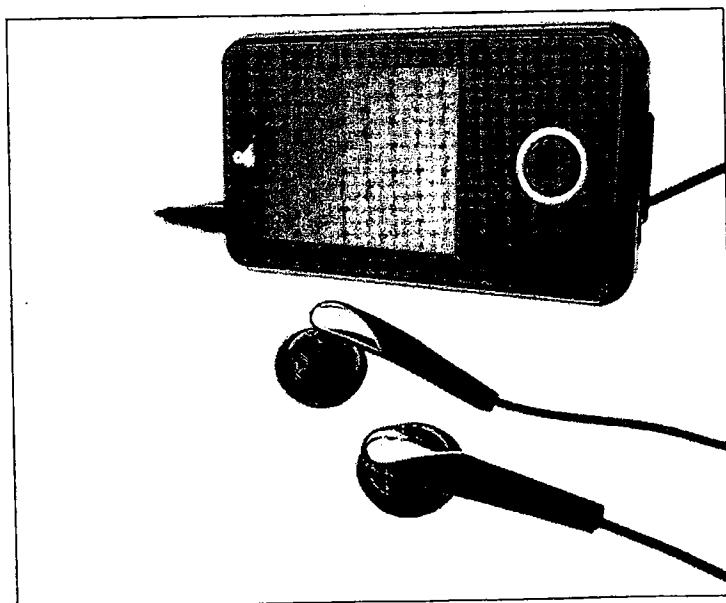
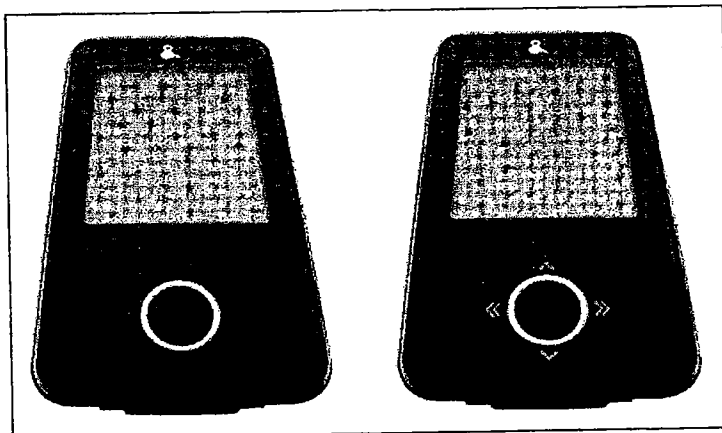
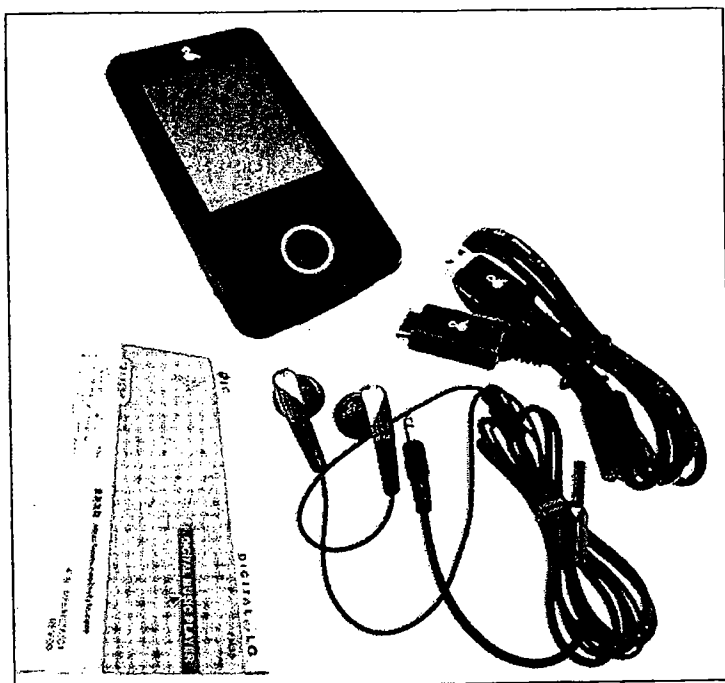

责任编辑: 高靖宇

第一页 1 2 3 4 5 6 7 8 9 最后页

Kodak 柯达  
V570



RETINA双镜头技术  
23毫米超广角  
5倍光学变焦

加 399元 即送  
柯达3系相片打印机



¥2599元

相关文章:

- 我是双芯的! DEC C150 512MB仅399元( 2006-06-29)
- 天籁之音 OPPO X17K 256M仅售499元( 2006-06-29)
- 明基暑假忙! 买DA102送精美挂链一条( 2006-06-29)
- 学生机杀手 三星C1 256M容量小降60元( 2006-06-29)
- 炎夏送清凉 理光巧克力冰淇淋版上市( 2006-06-29)
- 宏基高端商务机 TM8204 惊爆降价中( 2006-06-29)
- 神舟疾速X700独显 承运W280A降1000( 2006-06-29)
- S3000高配版也便宜 NEC白色本11988( 2006-06-29)
- IBM T60售价35000元 送429元电子鱼( 2006-06-29)
- 宏基高端系列Aspire 5672跌破12000( 2006-06-29)

论坛

用户名:   匿名 [申请新用户](#)

密 码:

内 容:

发表 清除

[查看最新评论](#)

网站合作、内容监督、商务咨询电话: 010-82660133  
 海龙资讯网所有文章和图片版权所有, 禁止一切非授权的转载和抄袭行为  
 网站经营许可证编号: \*京ICP证050702号



**HILON** 海龙资讯 | 首页 | 行情促销 | 新闻中心 | 报价中心 | 评测中心 | 显卡/DV | MP3/MP4 | 笔记本 | 硬件频道  
 摄影会 | 歌友会 | 论坛 | 海龙电子地图 | 网上投诉 | 海龙维修中心 | 海龙采风

## 黑白猜 LG新颖DMB MP3 FM35精美图赏

时间: 2006-06-29 作者: 来源: 海龙资讯

第4页: 多彩屏幕

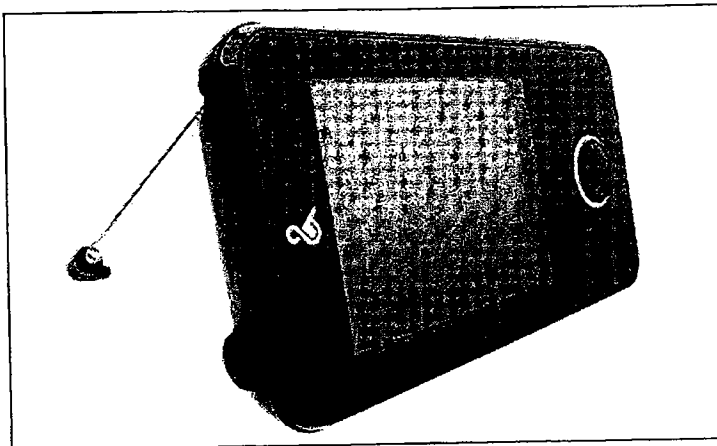

### 最新文章 New

- 神舟疾速X700独显 承运 W280A降1000
- IBM T60售价35000元 送429元电子鱼
- 大降500元 三星R50-CV04售9688元!
- 炎夏送清凉 理光巧克力冰淇淋版上市
- S3000高配版也便宜 NEC白色本11988
- 学生机杀手 三星CI 256M容量小降60元

### TOP4

- 和512M容量MP3说再见! 1G彩屏MP3导购
- 炎热挡不住 夏日狂降笔记本分享篇
- iPod video疯狂降价! 30G容量仅售2580
- MP4变PSP! JXD683 游戏MP4仅售750元
- 告别熬夜看世界杯! 彩屏MP3、MP4导购
- 不用锻炼臂力 家用长焦防抖相机选购

### 论坛热贴

- 教你如何刻录极品CD音乐碟
- DIY牛人自制MM机箱 男士至爱
- K8 超频完整教学
- 笔记本维修也分三六九等
- DELL30英寸LCD 3007WFP
- 939 Opteron明年继续出货



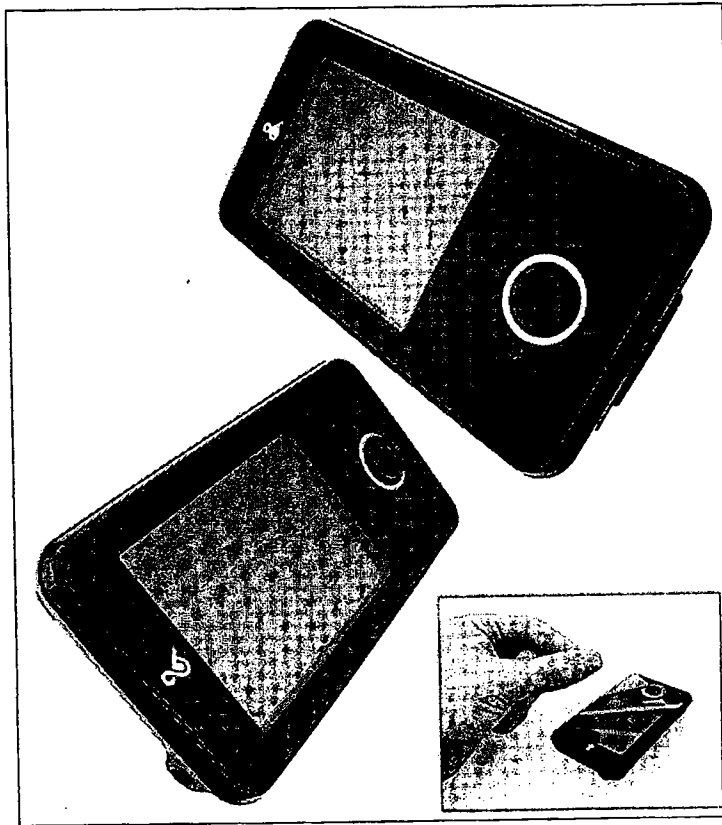
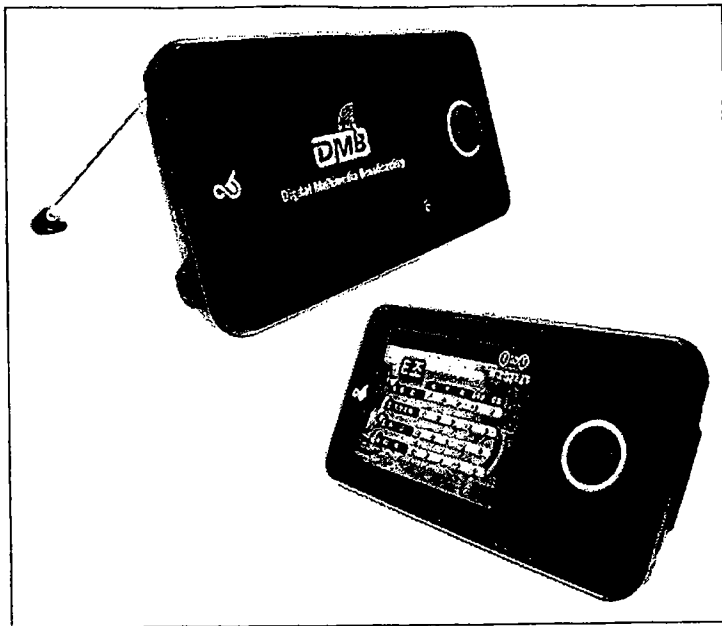

责任编辑：高靖宇

第一页 1 2 3 4 5 6 7 8 9 最后页

Kodak 柯达  
V570



RETINA双镜头技术  
23毫米超广角  
5倍光学变焦

加 399元 即送  
柯达3系相片打印机



¥2599元

相关文章：

- 我是双芯的！DEC C150 512MB仅售399元（2006-06-29）
- 天籁之音 OPPO X17K 256M仅售499元（2006-06-29）

论坛热议

用户名：

匿名  申请新用户

密码：

- 明基暑假忙! 买DA102送精美挂链一条( 2006-06-29)
- 学生机杀手 三星C1 256M容量小降60元( 2006-06-29)
- 炎夏送清凉 理光巧克力冰淇淋版上市( 2006-06-29)
- 宏基高端商务机 TM8204 惊爆降价中( 2006-06-29)
- 神舟疾速X700独显 承运W280A降1000( 2006-06-29)
- S3000高配版也便宜 NEC白色本11988( 2006-06-29)
- IBM T60售价35000元 送429元电子鱼( 2006-06-29)
- 宏基高端系列Aspire 5672跌破12000( 2006-06-29)

内 容:

发表

清除

[查看最新评论](#)

网站合作、内容监督、商务咨询电话: 010-82660133  
海龙资讯网所有文章和图片版权所有, 禁止一切非授权的转载和抄袭行为  
网站经营许可证编号: \*京ICP证050702号





**HILON** 海龙资讯

[首页](#) | [行情促销](#) | [新闻中心](#) | [报价中心](#) | [评测中心](#) | [PC/DV](#) | [MP3/MP4](#) | [笔记本](#) | [硬件频道](#)  
[爱摄会](#) | [歌友会](#) | [论坛](#) | [海龙电子地图](#) | [网上投诉](#) | [海龙维修中心](#) | [海龙采风](#)

搜索

## 黑白猜 LG新颖DMB MP3 FM35精美图赏

时间: 2006-06-29 作者: 来源: 海龙资讯

第5页: 八方展示

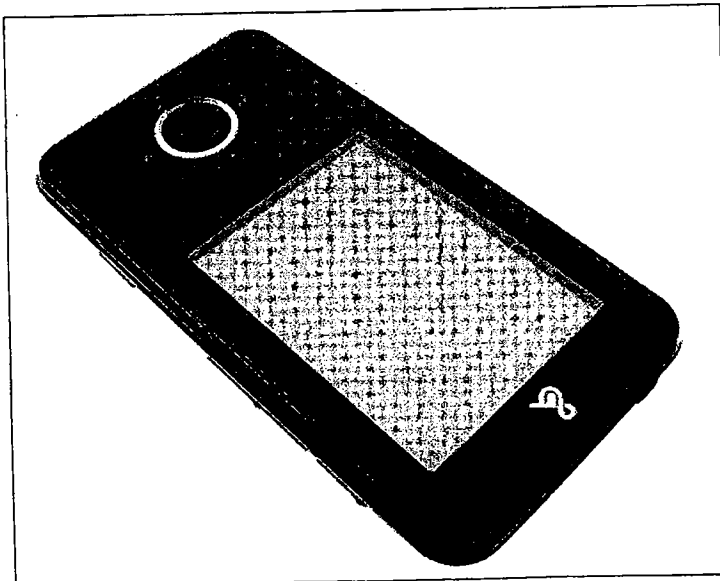
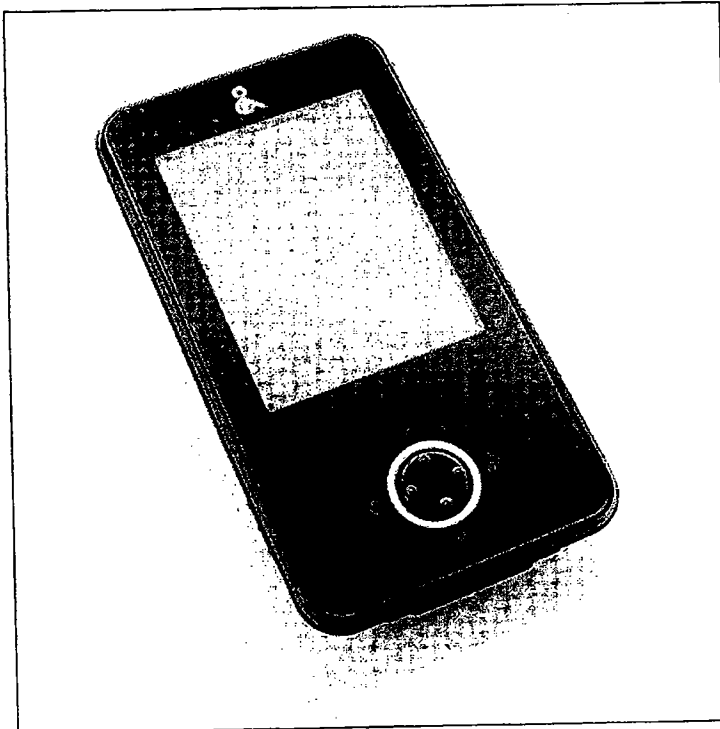

### 最新文章 New

- 神舟疾速X700独显 承运 W280A降1000
- IBM T60售价35000元 送429元电子鱼
- 大降500元 三星R50-CV04售9688元!
- 炎夏送清凉 理光巧克力冰淇淋版上市
- S3000高配版也便宜 NEC白色本11988
- 学生机杀手 三星C1 256M容量小降60元

### 本月文章TOP10

- ▶ 和512M容量MP3说再见! 1G彩屏MP3导购
- ▶ 炎热挡不住 夏日狂降笔记本分享篇
- ▶ iPod video疯狂降价! 30G容量仅售2580
- ▶ MP4变PSP! JXD683 游戏MP4仅售750元
- ▶ 告别熬夜看世界杯! 彩屏MP3、MP4导购
- ▶ 不用锻炼臂力 家用长焦防抖相机选购

### 论坛热贴

- 教你如何刻录极品CD音乐碟
- DIY牛人自制MM机箱 男士至爱
- K8 超频完整教学
- 笔记本维修也分三六九等
- DELL 30英寸LCD 3007WFP
- 939 Opteron明年继续出货



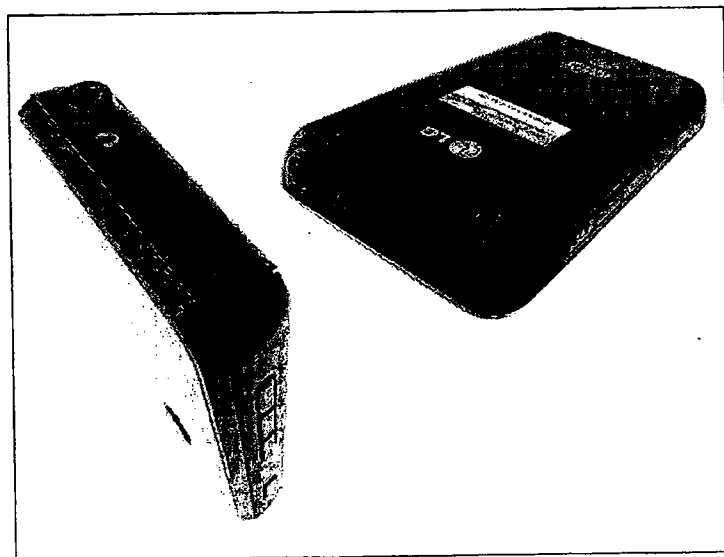
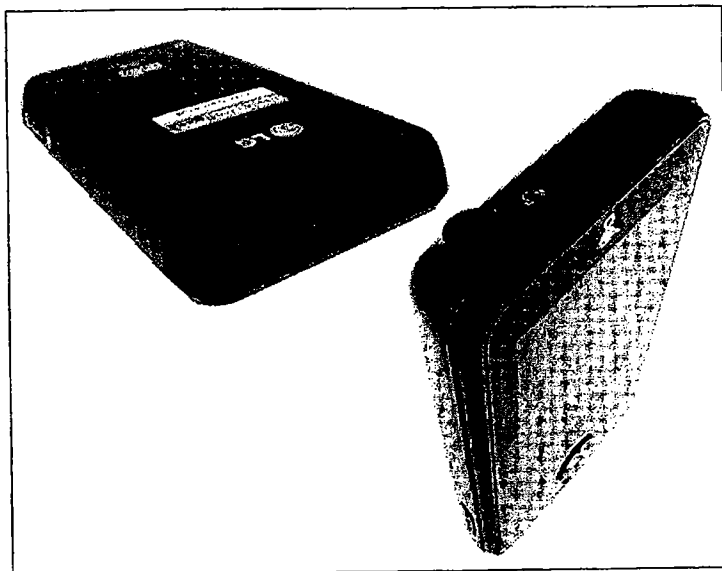

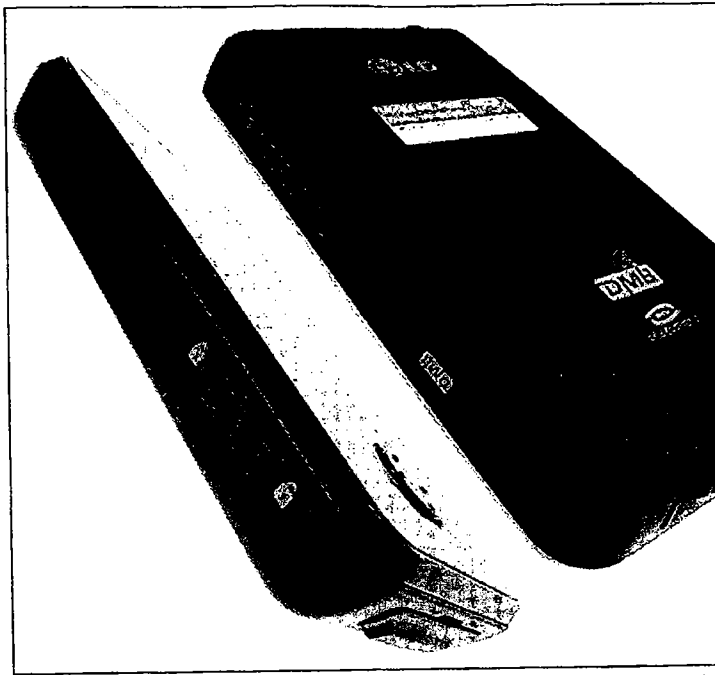

责任编辑: 高靖宇

第一页 1 2 3 4 5 6 7 8 9 最后页

Kodak 柯达  
V570



RETINA双镜头技术  
23毫米超广角  
5倍光学变焦

加399元即送  
柯达3系相片打印机

¥2599元



相关文章:

- 我是双芯的! DEC C150 512MB仅399元(2006-06-29)
- 天籁之音 OPPO X17K 256M仅售499元(2006-06-29)
- 明基器促忙! 买DA102送精美挂链一条(2006-06-29)
- 学生机杀手 三星C1 256M容量小降60元(2006-06-29)
- 炎夏送清凉 理光巧克力冰淇淋版上市(2006-06-29)
- 宏基高端商务机 TM8204 惊爆降价中(2006-06-29)
- 神舟疾速X700独显 承运W280A降1000(2006-06-29)
- S3000高配版也便宜 NEC白色本11988(2006-06-29)
- IBM T60售价35000元 送429元电子鱼(2006-06-29)
- 宏基高端系列Aspire 5672跌破12000(2006-06-29)

最新评论:

用户名:  匿名  申请新用户

密码: \_\_\_\_\_

内容: \_\_\_\_\_

发表 清除

查看最新评论

网站合作、内容监督、商务咨询电话: 010-82660133

海龙资讯网所有文章和图片版权所有, 禁止一切非授权的转载和抄袭行为

网站经营许可证编号: \*京ICP证050702号



**HILON** 海龙资讯

[首页](#) | [行情促销](#) | [新闻中心](#) | [报价中心](#) | [评测中心](#) | [DC/DV](#) | [MP3/MP4](#) | [笔记本](#) | [硬件频道](#)  
[爱摄会](#) | [歌友会](#) | [论坛](#) | [海龙电子地图](#) | [网上投诉](#) | [海龙维修中心](#) | [海龙采风](#)

搜索

## 黑白猜 LG新颖DMB MP3 FM35精美图赏

时间: 2006-06-29 作者: 来源: 海龙资讯

第6页: 万用天线

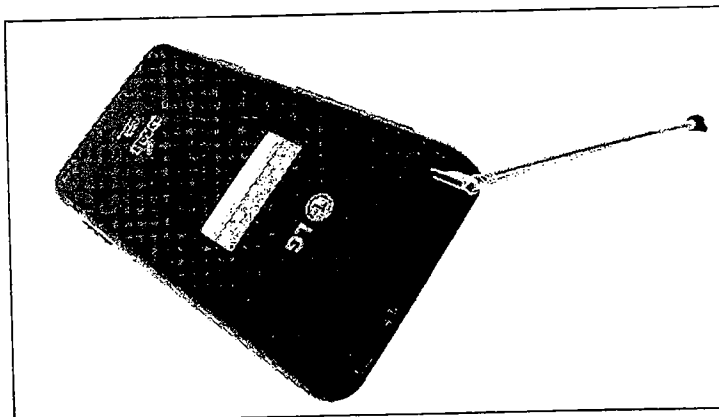
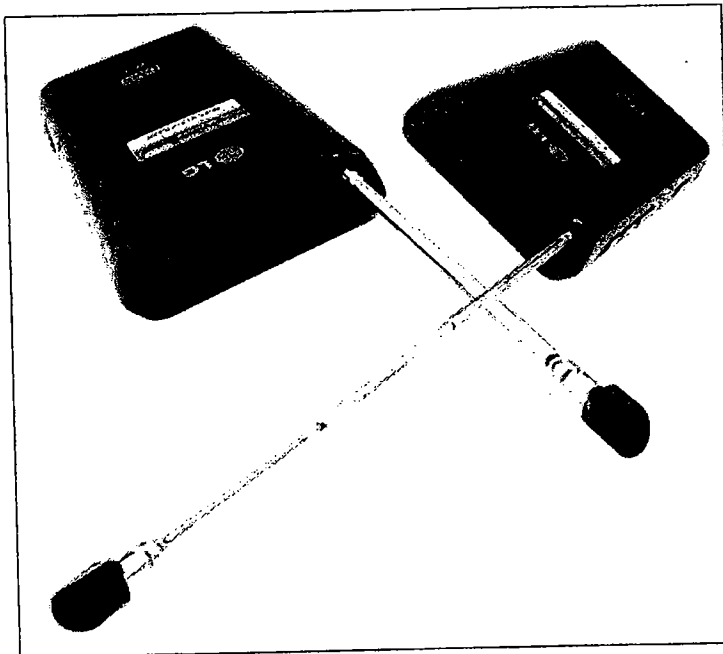

### 最新文章 New

- 神舟疾速X700独显 承运 W280A降1000
- IBM T60售价35000元 送429元电子鱼
- 大降500元 三星R50-CV04售9688元!
- 炎夏送清凉 理光巧克力冰淇淋版上市
- S3000高配版也便宜 NEC白色本11988
- 学生机杀手 三星C1 256M容量小降60元

### 本月最热门

- ▶ 和512M容量MP3说再见! 1G彩屏MP3导购
- ▶ 炎热挡不住 夏日狂降笔记本分享篇
- ▶ iPod video疯狂降价! 30G容量仅售2580
- ▶ MP4变PSP! JXD683 游戏MP4仅售750元
- ▶ 告别熬夜看世界杯! 彩屏MP3、MP4导购
- ▶ 不用锻炼臂力 家用长焦防抖相机选购

### -- 论坛热贴 --

- 教你如何刻录极品CD音乐碟
- DIY牛人自制MM机箱 男士至爱
- K8 超频完整教学
- 笔记本维修也分三六九等
- DELL.30英寸LCD 3007WFP
- 939 Opteron明年继续出货

海龙BS  
海龙论坛欢迎您!

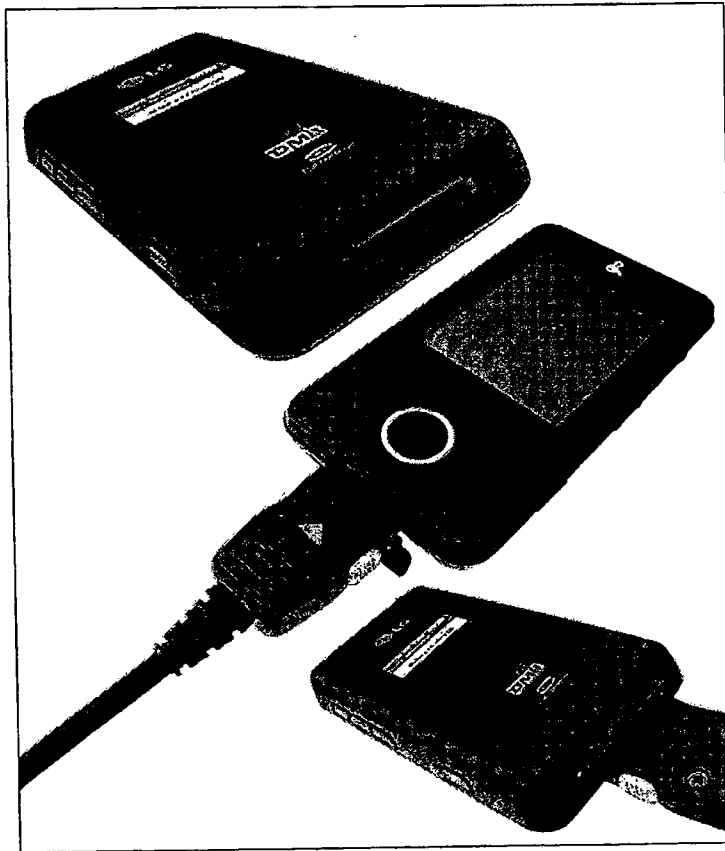
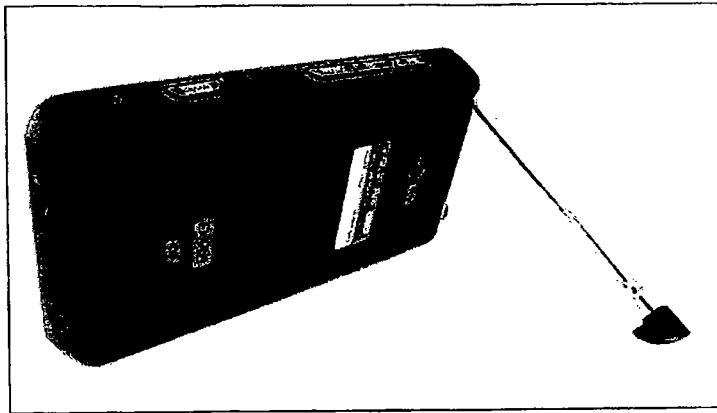

责任编辑: 高靖宇

第一页 1 2 3 4 5 6 7 8 9 最后页

**Kodak 柯达 V570**  RETINA双镜头技术 加**399元**即送**柯达3系相片打印机**  
 23毫米超广角 5倍光学变焦 **2599元**

相关文章:

- 我是双芯的! DEC C150 512MB仅售399元( 2006-06-29)
- 天籁之音 OPPO X17K 256M仅售499元( 2006-06-29)
- 明基暑假忙! 买DA102送精美挂链一条( 2006-06-29)
- 学生机杀手 三星C1 256M容量小降60元( 2006-06-29)
- 炎夏送清凉 理光巧克力冰淇淋版上市( 2006-06-29)
- 宏基高端商务机 TMS204 惊爆降价中( 2006-06-29)
- 神舟疾速X700独显 承运W280A降1000( 2006-06-29)
- S3000高配版也便宜 NEC白色本11988( 2006-06-29)

用户名:   匿名  申请新用户

密码:

内容:

- IBM T60售价35000元 送429元电子鱼( 2006-06-29)
- 宏基高端系列Aspire 5672跌破12000( 2006-06-29)

[查看最新评论](#)

网站合作、内容监督、商务咨询电话: 010-82660133  
海龙资讯网所有文章和图片版权所有, 禁止一切非授权的转载和抄袭行为  
网站经营许可证编号: \*京ICP证050702号



# 消费电子



4-10  
大奖等你拿!  
向英特尔峰会致敬  
打印机的未来!

西门子M65手机

## 手机精英 数码精英

### OPEN YOUR EYES

5款让你打开心扉的随身看

## 2004年终回顾之

# 我说三十六计

## 漫步在魔法花园

5款硬盘MP3随身听大巡礼

数字家居生活

## 家用电器每月消费指南



ISSN 1007-077X



**最佳搭档** 惠普 Photowalker 375 照片打印机 · **谁领** 数字影像格式之争  
**领航者** 索尼爱立信 P910c 手机 · **游遍空气中** 晟敏蓝牙耳机

# 新潮电子 领导数码时尚新生活 eFashion Magazine

国际刊号-ISSN 1007-077X 国内刊号-CN50-1077/TN

主管·科学技术部 **Authorities in charge**-Ministry of Science and Technology of the People's Republic of China  
主办·科学技术部西南信息中心 **Sponsor**-South West Information Center of MOST  
合作·电脑报社 **Cooperator**-China PC Weekly  
编辑出版·《新潮电子》杂志社 **Publication**-eFashion Magazines

**Editor-in-Chief 总编** 曾晓东 Zeng Xiaodong  
**Standing Deputy Editor-in-Chief 常务副总编** 陈宗周 Chen Zongzhou  
**Executive Deputy Editor-in-Chief 执行副总编** 谢东 / 谢宁倡 Xie Dong / Xie Ningchang  
**Operation Deputy Editor-in-Chief 业务副总编** 车东林 David Che  
**Marketing Deputy Editor-in-Chief 营销副总编** 张仪平 Zhang Yiping

**编辑部 Editorial Department**  
**Director [主任]** 范再生 Jason Fan  
**Vice-Director [副主任]** 陈旭 Phoebus Chen  
**Editor&Reporter [编辑·记者]** 蒲鹏 / 徐林 / 游宇 Paco Pu / Lynn Xu / Eric You  
赵宏伟 / 刘頌 / 望坤 Rocky Zhao / Thomas Liu / Kevin Wang  
董延斌 / 叶蕾 / 孔华 Joy Dong / Cloris Ye / When K  
**Tel [电话]** +86-23-63501706  
**Fax [传真]** +86-23-63513494  
**Homepage [网址]** <http://www.efashion.cn>  
**E-mail [电子邮箱]** [efashion@cniti.com](mailto:efashion@cniti.com)

**设计制作部 Designing Department**  
**Director [主任]** 郑亚佳 Coco Zheng  
**Art Editor [美术编辑]** 程若谷 / 邱江 / 黄幸 Raymond / Bloods / Huang Xin

**广告部 Advertising Department**  
**Director [主任]** 祝康 Kent Zhu  
**E-mail [电子邮箱]** [adv@cniti.com](mailto:adv@cniti.com)  
**Tel [电话]** +86-23-63509118

**发行部 Distribution Department**  
**Director [主任]** 杨胜 Yang Su  
**E-mail [电子邮箱]** [pub@cniti.com](mailto:pub@cniti.com)  
**Tel [电话]** +86-23-63501710 / 63536932

**市场部 Market Department**  
**Director [主任]** 白昆鹏 Kisan Bai  
**E-mail [电子邮箱]** [market@cniti.com](mailto:market@cniti.com)  
**Tel [电话]** +86-23-63521906

**读者服务部 Reader Service Department**  
**Homepage [网址]** <http://reader.cniti.com>  
**E-mail [电子邮箱]** [reader@cniti.com](mailto:reader@cniti.com)  
**Tel [电话]** +86-23-63521711

**Beijing Office 北京联络站** 霄锐 Light Xu  
**Tel [电话]** +86-10-82563520 / 82563521  
**Fax [传真]** +86-10-82563521-20  
**E-mail [电子邮箱]** [bjoffice@cniti.com](mailto:bjoffice@cniti.com)

**Shenzhen Office 深圳联络站** 张晓鹏 Zhang Xiaopeng  
**Tel [电话]** +86-755-83864778  
**Fax [传真]** +86-755-83864766  
**E-mail [电子邮箱]** [szoffice@cniti.com](mailto:szoffice@cniti.com)

**Shanghai Office 上海联络站** 李岩 Li Yan  
**Tel [电话]** +86-21-54900725  
**Fax [传真]** +86-21-54900726  
**E-mail [电子邮箱]** [shoffice@cniti.com](mailto:shoffice@cniti.com)

**Guangzhou Office 广州联络站** 张宪伟 Zhang Xianwei  
**Tel [电话]** +86-20-38299753  
**Fax [传真]** +86-20-38299234  
**E-mail [电子邮箱]** [gzoffice@cniti.com](mailto:gzoffice@cniti.com)

社址 中国重庆市胜利路132号  
邮政编码 400013  
邮局订阅代号 78-55  
发行 重庆市报刊发行局  
订阅 全国各地邮局  
零售 全国各地报刊零售点  
邮购 远望资讯读者服务部  
零售价 15元  
印刷 重庆建新印务有限公司  
出版日期 2004年12月1日

广告经营许可证 渝工商广字 020569号  
本刊常年法律顾问 中豪律师事务所

本刊作者授权本刊发表声明:

本刊图文版权所有, 未经允许不得任意转载或摘编。本刊(含远望资讯旗下所属媒体)及本刊授权合作网站为作者作品的指定使用单位。本刊根据著作权法有关规定, 向作者一次性支付稿酬。若白稿件刊发之日起两个月内未收到稿酬, 请与本刊联系。本刊作者发表的文章仅代表作者个人观点, 与本刊立场无关。作者投稿给本刊即意味着同意以上约定, 若有异议, 请事先与本刊签定书面协议。

承诺:

发现装订错误或缺页, 请将杂志寄回远望资讯读者服务部调换。





领导数码时尚新生活

# 新潮电子

eFashion Magazine

2004-12

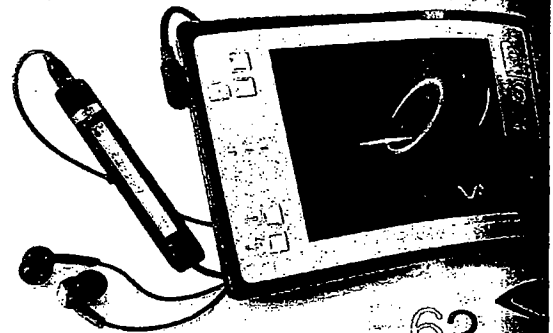

62

**P40**  
**冬日“表情”**  
 卡西欧系列腕表

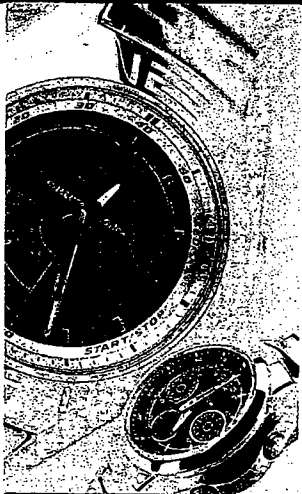

16 BESTBUY

18 e热讯 HotNews

## 视点 Viewpoint

20 “掌中影院”时代还有多远?

22 昙花一现 Or 前途无量?  
由三星 V5400 硬盘手机看开去

26 通信行业大变脸  
解读 2004 年国际通信展

29 视听盛宴  
索尼影音新品立体出击

## 尖峰体验 Experience

48 以退为进 轻装上阵  
柯尼卡美能达  
DiMAGE A200 数码相机

52 领航者  
索尼爱立信 P910c 手机

56 终结者和开拓者  
品味两款最新 Pocket PC Phone

62 ALL IN WONDER!  
索尼 VAIO VGN-U8C 迷你笔记本电脑

66 手机非常 体验非常  
西门子 M65 手机

70 专注与“花心”  
摩托罗拉 MPx220 智能手机

86 没落贵族  
palmOne TUNGSTEN T5 掌上电脑

90 情人  
奥林巴斯 μ-mini DIGITAL  
VS 佳能 Digital IXUS i<sup>9</sup>

94 锋芒乍现  
LG C910 手机

2004

年终回顾之 **戏说三十六计** P116 专辑

在即将告别 2004 年之际,我们并不希望以刻板而俗套的年终盘点来结束这异彩纷呈的一年。数码《三十六计》一个个尘封在你记忆深处的兵法故事即将具有全新的现代诠释。

幕背光均匀，色彩过渡自然，没有生硬的色块。而文字的显示则显得特别精细，字体笔画圆润，让人丝毫感觉不到屏幕缩小对阅读带来的负面影像。

CPU方面，多普达818采用了英特尔XScale PXA270 416MHz CPU，具备了较强的运算能力，也为多媒体应用打下了坚实的基础。同样，运行SPB Benchmark测试得到了1618分的总成绩，在同级别的Pocket PC中处于上游。看来，即便只是单纯作为PPC，818在目前的PPC市场上仍然可占有一席之地。

在关闭电话功能（即开启飞行模式），开启最大声音和最大背光，连续全屏播放有声视频的电池消耗测试中，使用多普达原配的3.7V 1200mAh电池得到了224分钟的成绩。在416MHz的频率下，能够有如此的表现，足以让用户对其续航能力放心。

简单的软件配备并不影响818的性能发挥，信奉经典也许才是优雅女人和个性男士真正需要的，而818也正是个中高手。

多普达818在软件配置上并没有大手笔，软件以操作系统自带的为主，但随机附带的“SIM卡管理器”和“Windows Media Player 1.0”等软件绝对算得上经典。此外，818在网络连接设置上还专门进行了强化，允许用户在设置菜单中对多种上网方式进行详细的设置。如允许用户对GPRS级数进行设置，可以分别选择Class 8（4+1）或Class 10（3+2），还用户更多的自由空间。

此外，130万像素的摄像头并没有配备太多花哨的拍摄功能，而是仅仅提供了选择照片尺寸（最大1280×960）、拍摄模式（静态还是动态）、存盘格式（JPEG或BMP）等项目，让用户可以在简单设置后享受拍摄的乐趣。拍摄状态可以直接和相册互相切换，随时浏览拍摄得到的照片，颇具人性化。

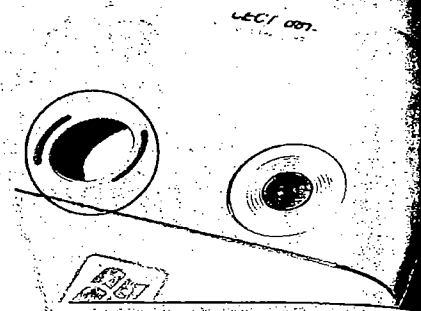

藏身于自拍镜下的扬声器整体表现不错

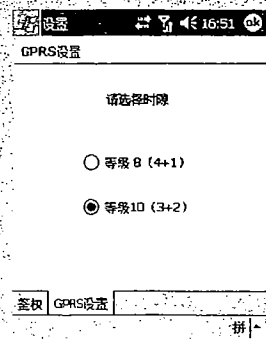

左 可选择GPRS级数的选项在应用中有实际的意义  
中 拍摄设置选项简单明了

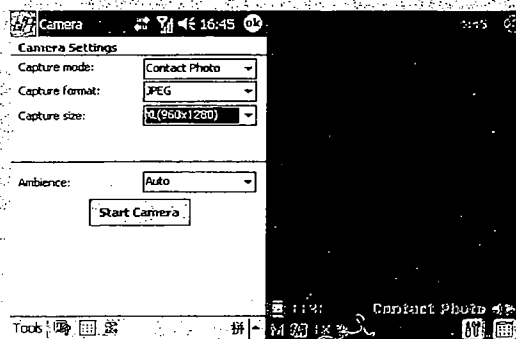

右 “连接”设置页面下，提供了极为丰富的设置项目，用户对于无线连接有了更多的自主权

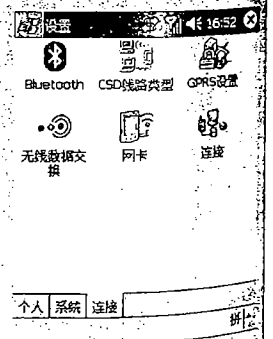

### 总结

在多普达818这位开拓者面前，出现的是一条光明大道，毕竟打开了顶起人类半边天的女性市场，就意味着PPC Phone在理论上多出了一倍的市场空间。更何况，多普达818并非仅仅适用于女性用户，它也容易得到大多数男性用户的青睐，毕竟用“砖块”长时间通话只能是权宜之计。

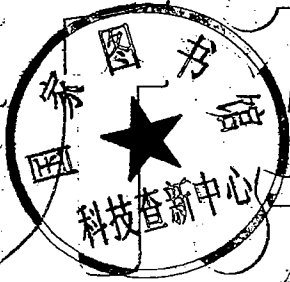

总第119期 2005年6月1日出版

素混合器

西欧 EX-1505 数码相机

# 贝克汉姆的胡渣

## 2006年世界杯之高清备战

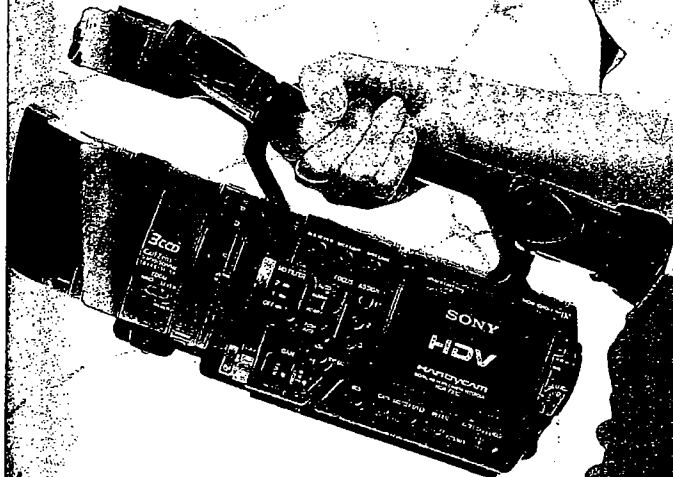

### 将会失去一切

## 家用电器每月消费指南

数字家居生活  
这是聪明的吸尘器  
用游戏机蓄势待发  
ing的智能厨房世界

ISSN 1007-077X



11> **DIY, 移动娱乐之旅** 打造属于自己的车载电脑 · **该怎么选择你, 我的“随身翻译”** PDA 词典软件大盘点  
**穿越季节的奥永** 感受避暑胜地的召唤 · **挡不住的趋势** Symbian 手机病毒介绍及防治 · **掘巷** 感悟城市旧巷的文化魅力

邮发资源 www.cnli.com ISSN 1007-077X(国际标准刊号) CN50-1077/TN(国内统一刊号) 邮发代号 78-55

# 新潮电子 领导数码时尚新生活 eFashion Magazine

国际刊号·ISSN 1007-077X 国内刊号·CN50-1077/TN

主管·科学技术部 **Authorities in charge**·Ministry of Science and Technology of the People's Republic of China  
主办·科学技术部西南信息中心 **Sponsor**·South West Information Center of MOST  
合作·电脑报社 **Cooperator**·China PC Weekly  
编辑出版·《新潮电子》杂志社 **Publication**·eFashion Magazines

Editor-in-Chief 总编 曾晓东 Zeng Xiaodong  
Standing Deputy Editor-in-Chief 常务副总编 陈宗周 Chen Zongzhou  
Executive Deputy Editor-in-Chief 执行副总编 谢东 / 谢宁倡 Xie Dong / Xie Ningchang  
Operation Deputy Editor-in-Chief 业务副总编 车东林 David Che  
Marketing Deputy Editor-in-Chief 营销副总编 张仪平 Zhang Yiping

## 编辑部 Editorial Department

Director [主任] 范再生 / Jason Fan  
Vice-Director [副主任] 胥锐 / 陈旭 Light Xu / Phoebus Chen  
Editor & Reporter [编辑·记者] 蒲鹏 / 徐林 Pao Pu / Lynn Xu  
贺延斌 / 张海涛 Joy Dong / Tide Chang  
叶慧 / 吴可佳 Cloris Ye / Woody Wu  
张晶 / 张翼 / 张燕 Jakin Zhang / Yale zhang / Nancy Zhang  
杨超 / 吴佳 Choy Yang / Wu Jia

Photograph Editor [摄影编辑] 游宇 / Eric You  
Art Editor [美术编辑] 程若谷 / 邱江 / 黄幸 / 陈静 Raymond / Bloods / Grant / Chen Jing

Tel [电话] +86-23-63501706  
Fax [传真] +86-23-63513494  
E-mail [电子邮箱] efashion@cniti.com

## 广告部 Advertising Department

Director [主任] 祝康 Kent Zhu  
Tel [电话] +86-23-63509118  
E-mail [电子邮箱] adv@cniti.com

Beijing Office 北京广告热线 胥锐 Light Xu  
Tel [电话] +86-10-82563520/82563521  
Fax [传真] +86-10-82563521-20  
E-mail [电子邮箱] bjoffice@cniti.com

Shanghai Office 上海广告热线 李岩 Li Yan  
Tel [电话] +86-21-54900725  
Fax [传真] +86-21-54900726  
E-mail [电子邮箱] shoffice@cniti.com

Guangzhou Office 广州广告热线 张宏伟 Zhang Xianwei  
Tel [电话] +86-20-38299753  
Fax [传真] +86-20-38299234  
E-mail [电子邮箱] gzoffice@cniti.com

Shenzhen Office 深圳广告热线 张晓鹏 Zhang Xiaopeng  
Tel [电话] +86-755-83864778  
Fax [传真] +86-755-83864766  
E-mail [电子邮箱] szoffice@cniti.com

## 营销部 Sales Department

Director [主任] 杨旌 Yang Su  
Vice-Director [副主任] 白昆鹏 / 牟燕红 Kisan Bai / Claudio Mu  
E-mail [电子邮箱] pub@cniti.com  
Tel [电话] +86-23-63501710/63536932

## 读者服务部 Reader Service Department

Homepage [网址] <http://reader.cniti.com>  
E-mail [电子邮箱] reader@cniti.com  
Tel [电话] +86-23-63521711

社址 中国重庆市胜利路 132 号

邮政编码 400013

邮局订代号 78-55

发行 重庆市报刊发行局

订户 全国各地邮局

零售 全国各地报刊零售点

邮购 远望资讯读者服务部

零售价 15 元

印刷 重庆建新印务有限公司

出版日期 2005 年 6 月 1 日

广告经营许可证 渝工商广字 020569 号

本刊常年法律顾问 中蒙律师事务所

本刊作者授权本刊发表声明:

本刊图文版权所有, 未经允许不得任意转载或摘编。本刊(含远望资讯旗下所属媒体)及本刊授权合作网站为作者作品的指定使用单位。本刊根据著作权法有关规定, 向作者一次付清稿酬。若自稿件刊发之日起两个月内未收到稿酬, 请与本刊联系。本刊作者发表的文章仅代表作者个人观点, 与本刊立场无关。作者投稿给本刊即意味着同意以上约定, 若有异议, 请事先与本刊签订书面协议。

承诺:

发现装订错误或缺页, 请将杂志寄回远望资讯读者服务部调换。