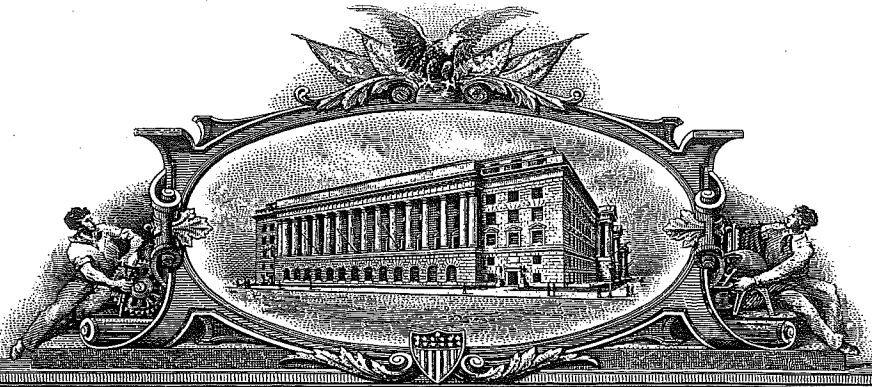

EXHIBIT 34

1874608



THE UNITED STATES OF AMERICA

TO ALL TO WHOM THESE PRESENTS SHALL COME;

**UNITED STATES DEPARTMENT OF COMMERCE
United States Patent and Trademark Office**

March 15, 2012

**THIS IS TO CERTIFY THAT ANNEXED IS A TRUE COPY OF
FOREIGN PATENT KR 30-0398307.**

**By Authority of the
Under Secretary of Commerce for Intellectual Property
and Director of the United States Patent and Trademark Office**



T. Lawrence

**T. LAWRENCE
Certifying Officer**

SAMNDCA00402644

(19)대한민국특허청(KR)
(12) 등록디자인공보(S)

(52) 분류 H5-40

(45) 공고일자

2005년11월15일

(11) 등록번호

30-0398307

(24) 등록일자

2005년11월07일

(51) 국제분류

14-02

(21) 출원번호

30-2005-0009073

(22) 출원일자

2005년03월21일

(73) 디자인권자

(주)블루버드 소프트
서울시 강남구 신사동 558-5

(72) 창작자

유주연
서울 성북구 정릉1동 1018-1 태영아파트 105동 804호

(74) 대리인

권영규
한지희
윤재석

담당심사관 천광신

※디자인보호법(법률 제7289호, 시행일 2005.7.1)에 의거 종전의 규정에 의한 의장은
이 법의 개정규정에 의한 디자인으로 봅니다.

(54) 개인휴대단말기(PDA)

디자인의 대상이 되는 물품

개인휴대단말기(PDA)

디자인의 설명

1. 재질은 금속, 합성수지 및 유리임.
2. PDA(Personal Digital Assistant)는 정보의 수집, 저장, 작성, 검색 및 통신기능이 결합된 개인휴대단말기(PDA)임.

디자인 창작 내용의 요점

"개인휴대단말기(PDA)"의 형상과 모양의 결합을 의장창작 내용의 요점으로 함.

【 사시도 】

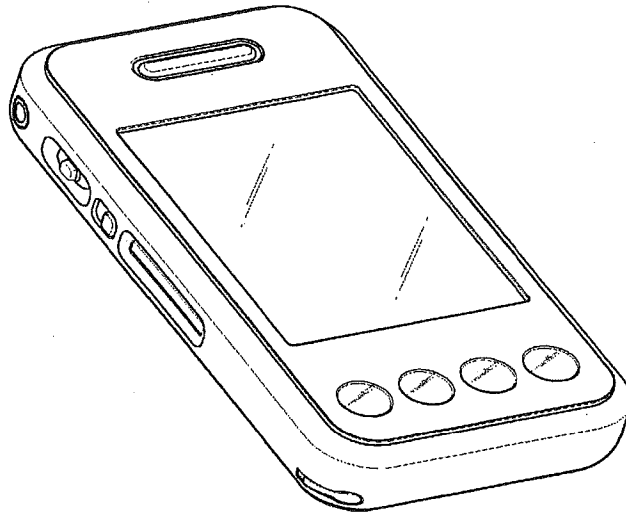

【 정면도 】

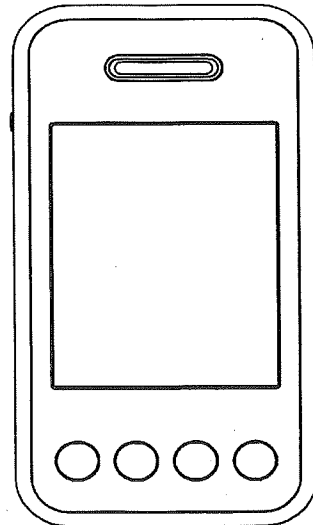

【 배면도 】

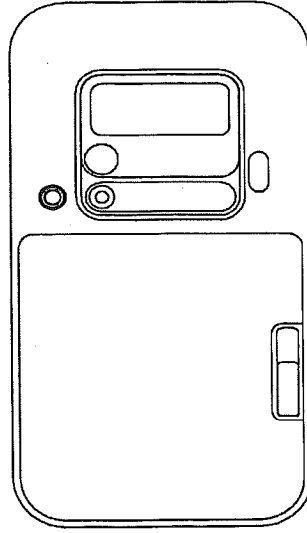

【 좌측면도 】



【 우측면도 】



【 평면도 】

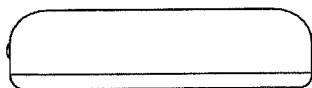

【 저면도 】

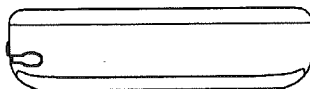

CERTIFICATION OF TRANSLATION

I certify that the Korean to English translation of the Korean document entitled *KR300398307* is an accurate and complete rendering of the contents of the source document to the best of my knowledge and ability. I further certify that I am a qualified professional translator familiar with both languages with more than twenty years of experience in Korean to English translation of various legal, technical or business documents including a number of legal evidentiary documents submitted to various courts in the United States.

May 8, 2012

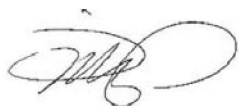

Alex N. Jo, Translator

1874C08



THE UNITED STATES OF AMERICA

TO ALL TO WHOM THESE PRESENTS SHALL COME;

**UNITED STATES DEPARTMENT OF COMMERCE
United States Patent and Trademark Office**

March 15, 2012

**THIS IS TO CERTIFY THAT ANNEXED IS A TRUE COPY OF
FOREIGN PATENT KR 30-0398307.**

**By Authority of the
Under Secretary of Commerce for Intellectual Property
and Director of the United States Patent and Trademark Office**



T. Lawrence

**T. LAWRENCE
Certifying Officer**

Perspective View

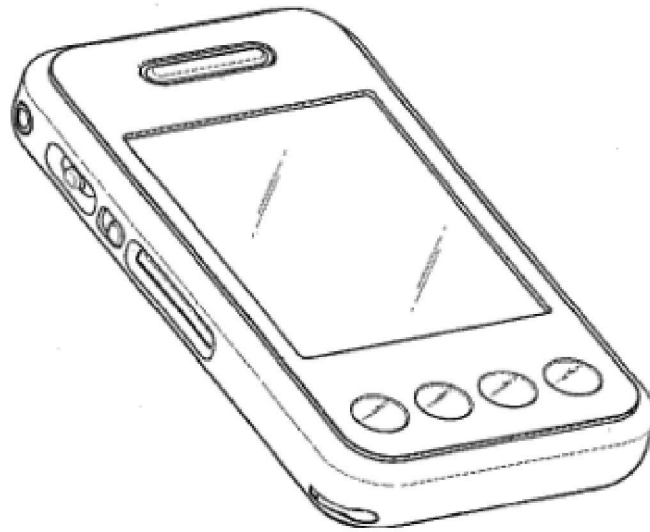

Frontal View

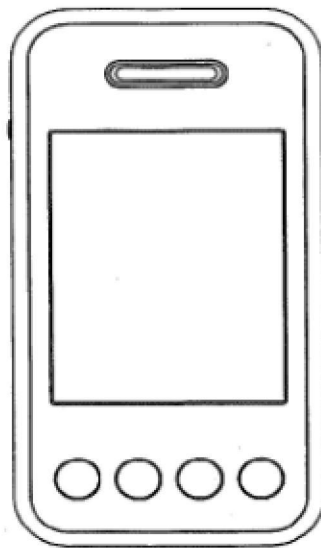

Rear View

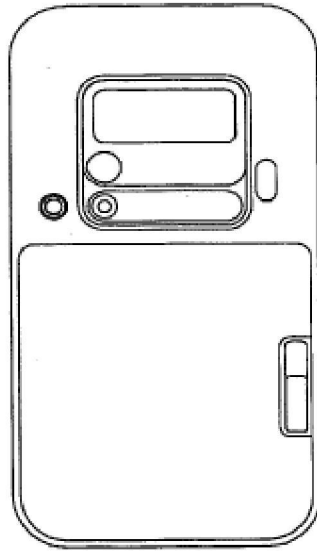

Left Lateral View

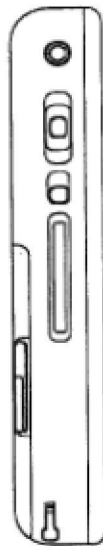

Right Lateral View



Plan View

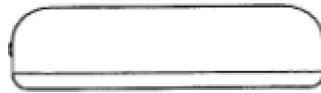

[Bottom View]

