

# EXHIBIT 39



US00D602015S

(12) **United States Design Patent**  
**Andre et al.**

(10) **Patent No.:** **US D602,015 S**

(45) **Date of Patent:** **\*\* Oct. 13, 2009**

(54) **ELECTRONIC DEVICE**

(75) Inventors: **Bartley K. Andre**, Menlo Park, CA (US); **Daniel J. Coster**, San Francisco, CA (US); **Daniele De Iulius**, San Francisco, CA (US); **Richard P. Howarth**, San Francisco, CA (US); **Jonathan P. Ive**, San Francisco, CA (US); **Steve Jobs**, Palo Alto, CA (US); **Duncan Robert Kerr**, San Francisco, CA (US); **Shin Nishibori**, Portola Valley, CA (US); **Matthew Dean Rohrbach**, San Francisco, CA (US); **Peter Russell-Clarke**, San Francisco, CA (US); **Douglas B. Satzger**, Menlo Park, CA (US); **Christopher J. Stringer**, Woodside, CA (US); **Eugene Antony Whang**, San Francisco, CA (US); **Rico Zorkendorfer**, San Francisco, CA (US)

(73) Assignee: **Apple Inc.**, Cupertino, CA (US)

(\*\*) Term: **14 Years**

(21) Appl. No.: **29/306,334**

(22) Filed: **Apr. 7, 2008**

(51) **LOC (9) Cl.** ..... **14-02**

(52) **U.S. Cl.** ..... **D14/341; D14/496; D14/203.7**

(58) **Field of Classification Search** ..... **D14/341-347, D14/420, 426, 427, 432, 439-441, 448, 496, D14/125, 129-130, 137, 138, 147, 156, 218, D14/247-248, 250, 389, 203.1-203.7; D10/65, D10/104; D18/6-7; D21/329, 686; D6/596, D6/601, 605; 455/90.3, 6.1, 556.2, 575.1, 455/575.3, 575.4; 379/433.01, 433.04, 433.06, 379/433.07; 361/814; 341/22; 345/169; 346/173**

See application file for complete search history.

(56) **References Cited**

**U.S. PATENT DOCUMENTS**

D337,569 S \* 7/1993 Kando ..... D14/341

(Continued)

**FOREIGN PATENT DOCUMENTS**

JP D1250487 9/2005

(Continued)

**OTHER PUBLICATIONS**

Samsung F700, announced Feb. 2007, [online], [retrieved on Feb. 8, 2007]. Retrieved from Internet, <URL:http://www.gsmarena.com>.

(Continued)

*Primary Examiner*—Cathron C Brooks

*Assistant Examiner*—Barbara Fox

(74) *Attorney, Agent, or Firm*—Sterne, Kessler, Goldstein & Fox P.L.L.C.

(57) **CLAIM**

The ornamental design for an electronic device, as shown and described.

**DESCRIPTION**

FIG. 1 is a front perspective view of an electronic device showing our new design;

FIG. 2 is a rear perspective view thereof;

FIG. 3 is a front view thereof;

FIG. 4 is a rear view thereof;

FIG. 5 is a side view thereof;

FIG. 6 is another side view thereof;

FIG. 7 is a top view thereof;

FIG. 8 is a bottom view thereof;

FIG. 9 is an enlarged perspective view of the top portion of the front face of the device as shown in FIG. 1;

FIG. 10 is an enlarged front view of the top portion of the front face of the device as shown in FIG. 3;

FIG. 11 is an enlarged perspective view of the bottom portion of the device as shown in FIG. 1; and,

FIG. 12 is an enlarged view of the bottom portion of the device as shown in FIG. 8.

The broken lines shown in the drawings represent unclaimed portions of the electronic device and form no part of the claimed design.

**1 Claim, 3 Drawing Sheets**

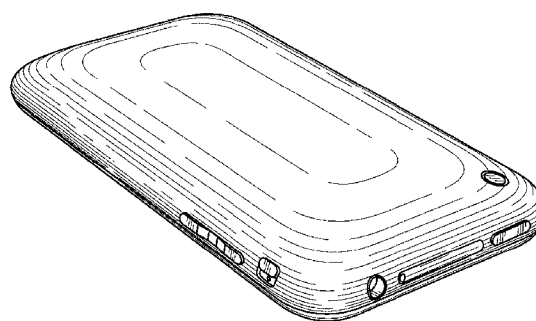
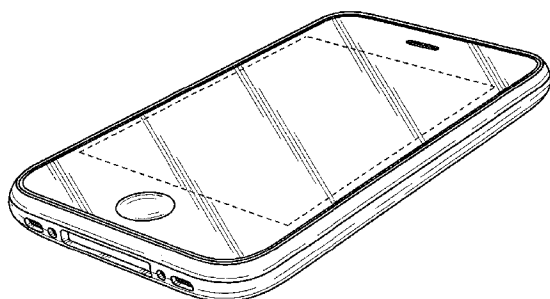

U.S. PATENT DOCUMENTS

D420,354 S 2/2000 Morales  
 D424,535 S 5/2000 Peltola  
 6,297,795 B1\* 10/2001 Kato et al. .... 345/684  
 D498,754 S 11/2004 Blyth  
 D504,889 S\* 5/2005 Andre et al. .... D14/341  
 D505,950 S 6/2005 Summit et al.  
 D514,590 S\* 2/2006 Naruki .... D14/203.3  
 D519,116 S 4/2006 Tanaka et al.  
 D520,020 S 5/2006 Senda et al.  
 D527,379 S\* 8/2006 Oe et al. .... D14/248  
 D528,542 S 9/2006 Luminosu et al.  
 D528,561 S 9/2006 Ka-Wei et al.  
 D529,045 S 9/2006 Shin  
 D532,791 S 11/2006 Kim  
 D534,143 S 12/2006 Lheem  
 D535,281 S\* 1/2007 Yang .... D14/203.3  
 D536,691 S 2/2007 Park  
 D536,962 S\* 2/2007 Tanner .... D9/424  
 D541,298 S 4/2007 Andre et al.  
 D541,299 S\* 4/2007 Andre et al. .... D14/496  
 D546,313 S 7/2007 Lheem  
 D548,732 S 8/2007 Cebe et al.  
 D548,747 S 8/2007 Andre et al.  
 D556,211 S 11/2007 Howard  
 D557,238 S 12/2007 Kim  
 D557,259 S\* 12/2007 Hirsch .... D14/217  
 D558,460 S 1/2008 Yu et al.  
 D558,756 S\* 1/2008 Andre et al. .... D14/341  
 D558,757 S\* 1/2008 Andre et al. .... D14/341  
 D558,758 S\* 1/2008 Andre et al. .... D14/341  
 D558,792 S 1/2008 Chigira  
 D559,220 S 1/2008 Lee et al.  
 D560,192 S 1/2008 Lee et al.  
 D560,683 S 1/2008 Lee  
 D560,686 S 1/2008 Kim  
 D561,153 S 2/2008 Hong et al.  
 D561,204 S\* 2/2008 Toh .... D14/496  
 D561,782 S 2/2008 Kim  
 D562,285 S 2/2008 Lim  
 D563,432 S\* 3/2008 Kim .... D14/496  
 D563,929 S 3/2008 Park  
 D568,309 S\* 5/2008 Cebe et al. .... D14/341  
 D575,259 S 8/2008 Kim et al.  
 D578,500 S 10/2008 Lee et al.  
 D579,898 S 11/2008 Lee et al.  
 D580,387 S\* 11/2008 Andre et al. .... D14/138 R  
 D581,384 S 11/2008 Kim et al.  
 D581,922 S 12/2008 Andre et al.  
 D583,345 S\* 12/2008 Kim et al. .... D14/138 AD  
 D584,272 S\* 1/2009 Chung et al. .... D14/138 R  
 D584,303 S\* 1/2009 Andre et al. .... D14/341  
 D584,646 S\* 1/2009 Sanguinetti .... D10/65  
 D584,711 S\* 1/2009 Kim et al. .... D14/138 G  
 D584,738 S\* 1/2009 Kim et al. .... D14/496  
 2003/0125079 A1\* 7/2003 Park et al. .... 455/556  
 2004/0132499 A1 7/2004 Abe  
 2004/0166907 A1 8/2004 Yajima  
 2004/0223004 A1 11/2004 Lincke et al.  
 2007/0082718 A1 4/2007 Yoon et al.

2008/0004085 A1 1/2008 Jung et al.

FOREIGN PATENT DOCUMENTS

KR 30-0394921 12/2005

OTHER PUBLICATIONS

Philips S900, announced Jun. 2006, [online], [retrieved on Feb. 20, 2007]. Retrieved from Internet ,<URL:http://www.gsmarena.com>.  
 LG KE850 Prada, announced Jan. 2007, [online], [retrieved on Feb. 20, 2007]. Retrieved from Internet ,<URL:http://www.gsmarena.com>.  
 Apple iPhone, announced Jan. 2007, [online], [retrieved on Mar. 12, 2007]. Retrieved from Internet ,<URL:http://www.gsmarena.com>.  
 Tinnos PDA, posted May 19, 2006, [online], [retrieved on Aug. 22, 2007]. Retrieved from Internet ,<URL:http://www.mobilewhack.com>.  
 Meizu M8, posted Jan. 29, 2007, [online], [retrieved on Sep. 13, 2007]. Retrieved from Internet ,<URL:http://www.engadget.com>.  
 Hilon LG DMB MP3 FM35, posted Jun. 26, 2006, [online], [retrieved on Dec. 26, 2008]. Retrieved from Internet ,<URL: http://hilon.com.cn.autobak/a8810005549>.  
 eFashion Magazine, No. 12 (2004), p. 60.  
 eFashion Magazine, No. 119 (Jun. 1, 2005), p. 45.  
 eFashion Magazine, No. 172 (Apr. 2006), p. 26.  
 U.S. Appl. No. 29/282,831, Andre et al., Electronic Device, filed Jul. 30, 2007.  
 U.S. Appl. No. 29/282,832, Andre et al., Electronic Device, filed Jul. 30, 2007.  
 U.S. Appl. No. 29/282,833, Andre et al., Electronic Device, filed Jul. 30, 2007.  
 U.S. Appl. No. 29/284,187, Andre et al., Electronic Device, filed Aug. 31, 2007.  
 U.S. Appl. No. 29/284,188, Andre et al., Electronic Device, filed Aug. 31, 2007.  
 U.S. Appl. No. 29/284,269, Andre et al., Electronic Device, filed Sep. 4, 2007.  
 U.S. Appl. No. 29/284,271, Andre et al., Electronic Device, filed Sep. 4, 2007.  
 U.S. Appl. No. 29/284,272, Andre et al., Electronic Device, filed Sep. 5, 2007.  
 U.S. Appl. No. 29/284,276, Andre et al., Electronic Device, filed Sep. 5, 2007.  
 U.S. Appl. No. 29/284,288, Andre et al., Electronic Device, filed Sep. 5, 2007.  
 U.S. Appl. No. 29/284,308, Andre et al., Electronic Device, filed Sep. 5, 2007.  
 U.S. Appl. No. 29/284,310, Andre et al., Electronic Device, filed Sep. 5, 2007.  
 U.S. Appl. No. 29/284,312, Andre et al., Electronic Device, filed Sep. 5, 2007.  
 U.S. Appl. No. 29/306,950, Andre et al., Electronic Device, filed Apr. 18, 2008.  
 U.S. Appl. No. 29/319,239, Andre et al., Electronic Device, filed Jun. 5, 2008.  
 U.S. Appl. No. 29/319,377, Andre et al., Electronic Device, filed Jun. 6, 2008.  
 U.S. Appl. No. 29/319,433, Andre et al., Electronic Device, filed Jun. 9, 2008.

\* cited by examiner

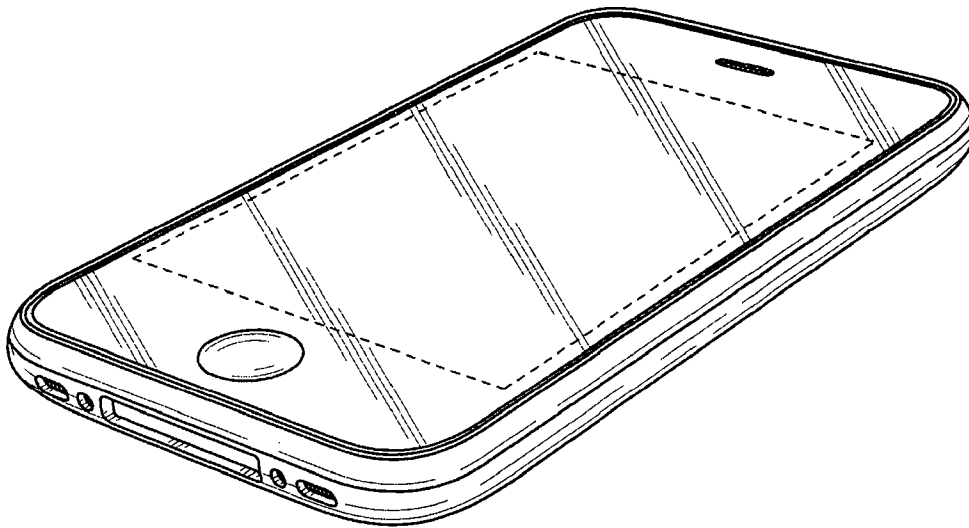

**FIG. 1**

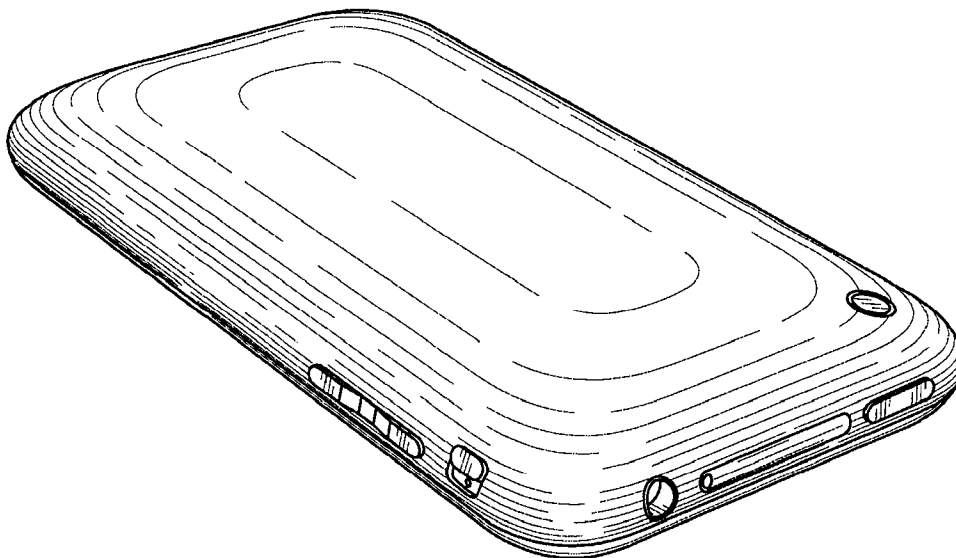

**FIG. 2**

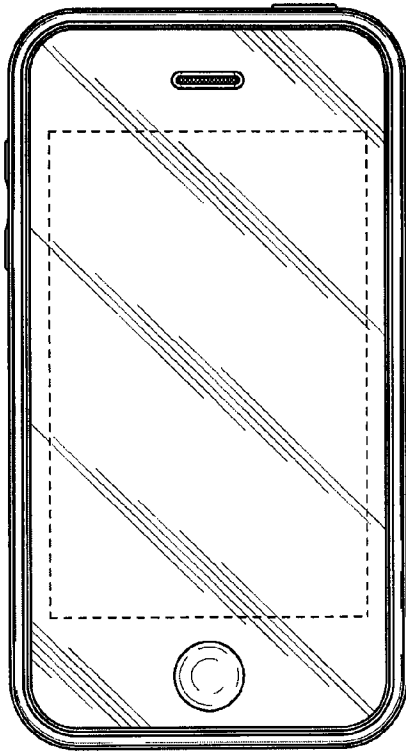

FIG. 3

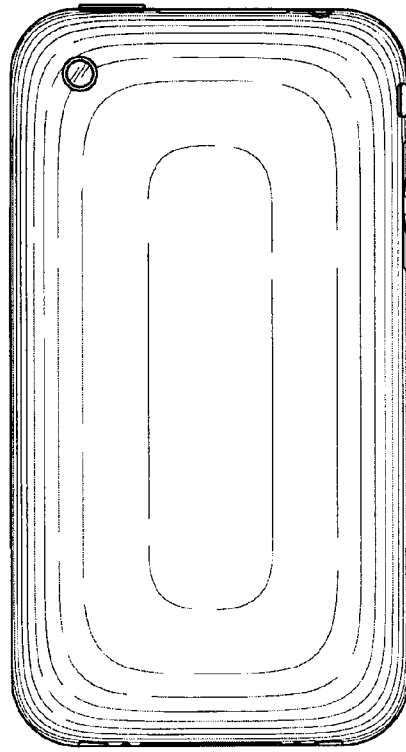

FIG. 4

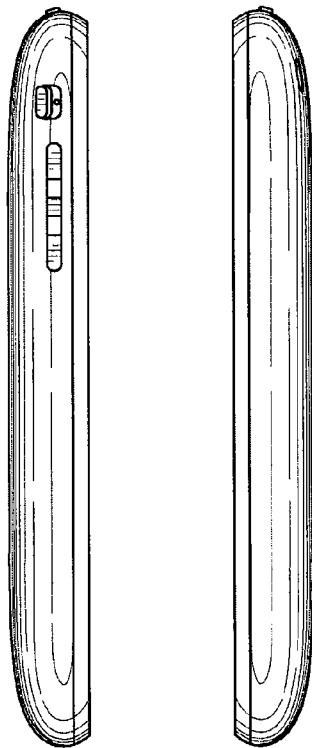

FIG. 5

FIG. 6



FIG. 7



FIG. 8

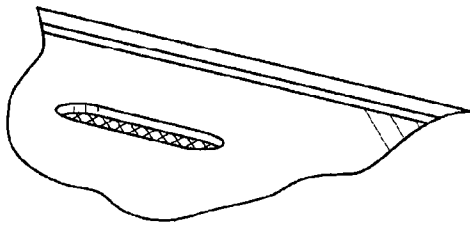

FIG. 9

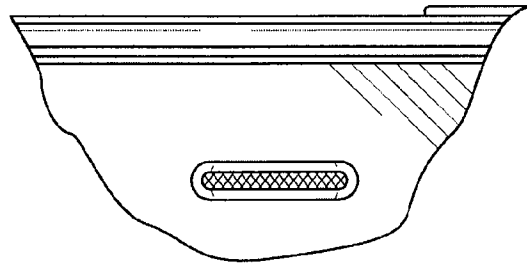

FIG. 10

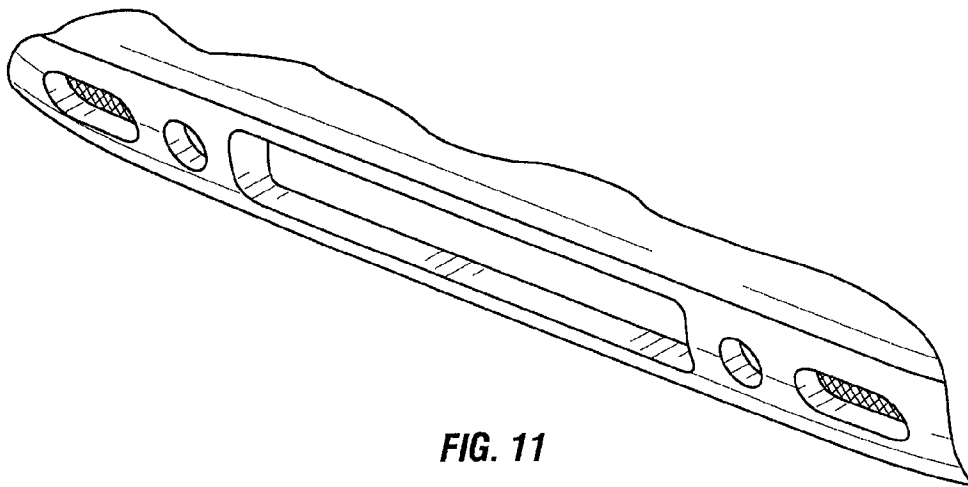

FIG. 11

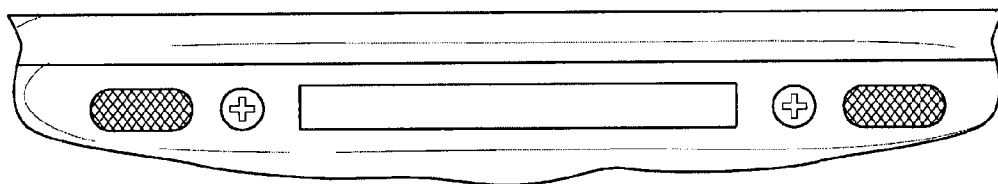

FIG. 12