

# **KANG DECLARATION EXHIBIT 21**

**Bressler Decl. In Support of  
Apple's Opp. to Samsung's  
Mot. For Summary  
Judgment**

**Ex. 38**

**Filed Under Seal**

Peter Mauro Schroepfer  
6397 Thornhill Dr.  
Oakland, CA 94611

510.290.3439  
schroepfer@gmail.com  
seobanseok@gmail.com

Certificate of Translation

March 12, 2012

I hereby certify that this Korean to English translation the document with the beginning Bates number S-ITC-007849424 is an accurate and complete rendering of the contents of the source document to the best of my knowledge, except for the word "TRANSLATION" at the upper right corner of each translated page. I further certify that I translated said document, that I am competent in both languages and have twenty years of professional experience in Korean to English translation.

By:   
Peter Mauro Schroepfer

# Aries-Q (GT-I9050)

## Global GSM Level. 2

Department		Responsible Executive	Working Level
Product Planning	PP	Vice President HanGil Yoon	Senior Manager ByungJin Kang, Assistant Manager IkSun Kang
	PM	Vice President JoonYoung Kim	Senior Manager HyukMin Kwon, Manager HyunDuk Yang
	VPS	Vice President JongIn Kim	Senior Manager TaeGil Kim, Assistant Manager DalWon Kim
Enabling		Vice President YongBae Lee	Manager JongHoon Park, Associate EonJi Lee
Development	PM	Vice President TaeMoon Noh	Vice President TaeMoon Noh
	PL		Vice President HakSang Kim
	H/W		Lead SangRyul Park
	S/W	Senior Vice President SeungHwan Cho	Principal WonIk Ahn
	Device	Vice President HyunMyung Song	Lead ByungJoon Lee, Senior HeeJun Lee
	Sound Lab.	Vice President JunTae Kim	Senior JoBong Cho, Associate SookKyung Kim
	Antenna	Vice President SukHo Kim	Lead DongHwan Kim, Associate JaeHo Lim
	SE Group	Vice President TaeShik Kim	Lead DongIk Shin, Lead JongSook Lee, Associate SungRae Cho
Design	Product	Vice President SukGeun Kim	Principal MinHyouk Lee, Associate GiYoung Lee
	UX	Vice President DongHoon Chang	AUI Lead JoongSam Yoon, UI Senior YoungMi Kim, GUI Lead SoYoung Yoon
R&D Management		Senior Vice President DongJin Ko	Senior Manager JinGyu Kim, Manager YoungJoong Kim
Sales		Senior Vice President HeungShik Cho, Senior Vice President YoungWoo Lee, Vice President GiYong Suh, Vice President GeunIk Yoo, Vice President MyungDong Park, Vice President ChulJin Kim	
Purchasing		Vice President JongKwon Lim	Senior Manager, ImSoon Lee, Assistant Manager GyungPil Kim
MSC		Vice President KyungHan Lee	Head of Department SungWon Cho, Assistant Manager HyungSoo Kim
CS Team (Reliability)		Vice President DooPyo Yoon	Senior Manager JungTae Lee, Manager Yong Kim
Product Technology H/W S/W		Vice President TekWon Ryu Vice President JungHo Baek	Senior Manager HyunGyu Park Manager DongGu Kim, Manager YoonDo Huh

# Aries-Q (GT-I9050)

## Global GSM Level. 2

Department		Responsible Executive	Working Level
Product Planning	PP	Vice President Hangil Yoon	Senior Manager ByungJin Kang, Associate JiWon Ahn
	PM	Vice President Joonyoung Kim	Senior Manager HyukMin Kwon, Manager HyunDuk Yang
	VPS	Vice President Jongin Kim	Senior Manager TaeGil Kim, Assistant Manager DalWon Kim
Enabling		Vice President Yongbae Lee	Manager JongHoon Park, Associate EonJi Lee
Development	PM	Vice President Taemoon Noh	Vice President HakSang Kim
	PL		Principal ByungDo Ahn
	H/W		Lead YeonBum Kim
	S/W	Senior Vice President Seunghwan Cho	Lead JoonHyuk Lee
	Device	Vice President Hyunmyung Song	Senior oonChul Lee
	Sound Lab.	Vice President Juntae Kim	Senior JoBong Cho, Associate SookKyung Kim
	Antenna	Vice President Sukho Kim	Lead DongHwan Kim, Associate JaeHo Lim
	SE Group	Vice President Taeshik Kim	Lead DongIk Shin, Lead JongSook Lee, Associate SungRae Cho
Design	Product	Vice President Sukgeun Kim	Principal MinHyouk Lee, Associate JinHoo Lee
	UX	Vice President DongHoon Chang	AUI Lead JoongSam Yoon, UI Senior HyoYoung Kim, GUI Senior JunSuk Kim
R&D Management		Senior Vice President DongJin Ko	Senior Manager JinGyu Kim, Assistant Manager SungMi Kim
Sales		Senior Vice President HeungShik Cho, Senior Vice President YoungWoo Lee, Vice President GiYong Suh, Vice President GeunIk Yoo, Vice President MyungDong Park, Vice President ChulJin Kim	
Purchasing		Vice President JongKwon Lim	ImSoon Lee Senior Manager, , Assistant Manager GyungPil Kim
MSC		Vice President KyungHan Lee	Department Head SungWon Cho, Manager HyungSoo Kim
CS Team (Reliability)		Vice President DooPyo Yoon	Senior Manager JungTae Lee, Manager Yong Kim
Product Technology H/W S/W		Vice President TekWon Ryu Vice President JungHo Baek	Senior Manager HyunGyu Park Manager DongGu Kim, Manager YoonDo Huh

# **0. Content**

*CONFIDENTIAL*

*£*

## **1. Positioning**

- Roadmap
- Competition map

## **2. Sales Point**

## **3. Competitor Comparison**

## **4. Evaluation**

## **5. Specification**

- H/W
- S/W
- UX
- Service
- CMF
- Assignment Check List

## **6. VPS**

## **7. Target Sales Volume, Price and Profit**

## **8. PLC**













## **9. Schedule**

## **10. Summary**

# 1-1. Positioning – Roadmap

CONFIDENTIAL  
I

Confidential Business Information -- Subject to Protective Order

Competitor	2009	2010
	2H	1H
<b>SonyEricsson</b> <b>Xperia X10</b>  '10.03 8MP 4" qHD Rachael UI 3.5pi earjack		 <b>Halo</b> '10.05 8MP/HSUPA5.76 3.7 WVGA OCT AMOLED Mobile Projector GII Eclair
<b>Moto</b> <b>Milestone</b>  '09.11 5MP 3.7 WVGA Eclair	 <b>I7500 (Galaxy)</b> '09.07 5MP/HSUPA 3.2" HVGA AMOLED 8GB + microSD Cupcake	 <b>Aries-Q</b> '10.06 5MP/HSUPA5.76 4.0 WVGA OCT AMOLED Touch+QWERTY Eclair
<b>HTC Hero</b>  '09.06 5MP 3.2 HVGA Sense UI		 <b>Aries</b> '10.05 5MP/HSUPA5.76 4.0 WVGA OCT AMOLED 9.9mm Eclair
<b>LG GW620</b>  '09.11 5MP 3.0 HVGA S Class UI	 <b>I5700 (Spica)</b> '09.10 3MP/HSDPA3.6 3.2" HVGA Affordable Android Cupcake → Eclair	<b>China Only</b>  <b>Saturn</b> '10.02 3MP/HSUPA 5.76 3.2" HVGA AMOLED Eclair
<b>HTC Tattoo</b>  '09.10 3MP 2.8 QVGA Sense UI Multi-Touch		 <b>Apollo</b> '10.05 3MP/HSDPA3.6 3.2" WQVGA 1GB MicroSD Eclair
		 <b>Europa</b> '10.06 2MP/HSDPA7.2 2.8" QVGA 1GB MicroSD Eclair

S-ITC-007849427

# 1-2. Positioning – Competition map

Confidential Business Information -- Subject to Protective Order

S-ITC-007849428

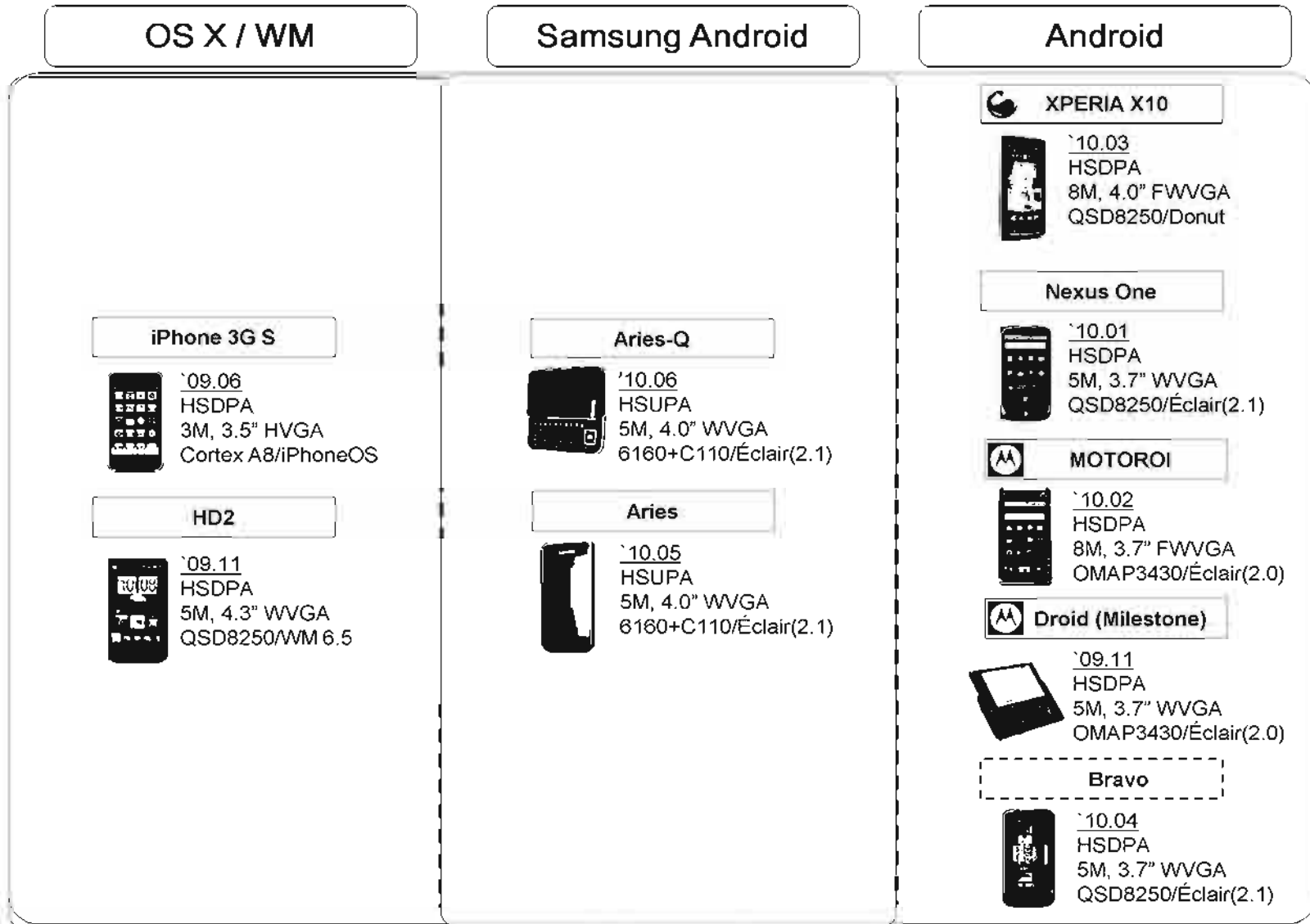



## 2. Sales Point

CONFIDENTIAL  
I

# “The S : Samsung Superior Smartphone”

### 1 Stylish, Slim & Minimal Design

- 4.0" Large Super AMOLED
- 9.9t Ultra-Slim w/ 1500 mAh Batt.
- Seamless Tempered Glass

### 2 Powerful Performance

- Higher CPU Performance (1GHz)
- HD Video (720p) Play/Recording
- Fast Speed: WiFi n, BT3.0, HSUPA 5.76

### 3 Fully ranged Accessories

- Speaker Cradle, External Battery
- Projector, Navi-kit



### New User eXperience 4

- Social Hub : Integrated Phonebook
- TouchWiz 3.0 w/ Hybrid Widgets (Hybrid Clock/Stock, Daily Briefing etc)
- Smart Life Enabler: Context-Aware

### Advanced Features 5

- Augmented Reality w/ Global POI
- Convergence by AllShare
- Enhanced Multimedia & Security

### Rich Contents 6

- E-book optimized for Large OCTA
- Expandable by Samsung Kies

## “Google Co-marketing”

with Google™

## 2. Sales Point - Design

CONFIDENTIAL  
I

### Design Concept

- Wide & Large Touch Display
- Ultra-Slim (9.9t) : 64.2 x 122.4 x 9.9 mm
- Minimal Design
- Comfortable Hand Grip

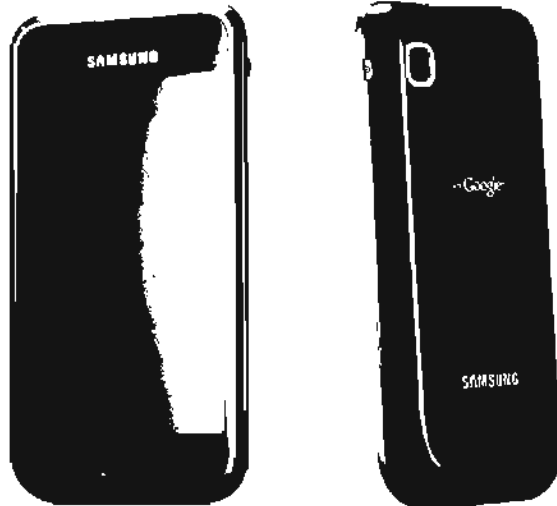

- 4.0 " WVGA On-Cell TSP AMOLED Display
- 9.9t Ultra-Slim Thickness (w/ 1500mAh battery)
- Refined Minimal Design
- Ergonomic Edge for Comfortable One-hand grip

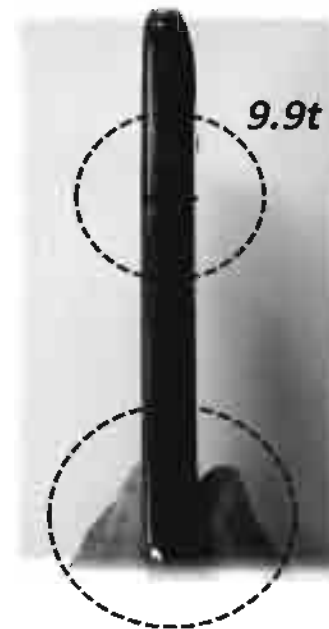

**Upward round for comfortable hand grip**

#### Competitors

Apple  
iPhone 3GS  
12.3 mm

HTC  
NexusOne  
11.5 mm

## 2. Sales Point - Display

CONFIDENTIAL  
I

**“Super AMOLED : Crystal-clear & Ultra-thin Large Display”**

✓ OCTA (On-Cell TSP AMOLED) : No Air Gap between Window Glass & LCD



Vivid Color

High Contrast

10000:1

Outstanding Luminescence



- Borderless Display

- Better Sunlight Visibility

### Super AMOLED

Normal AMOLED

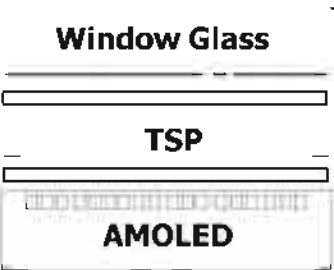

2.87t

Super AMOLED

0.53t save

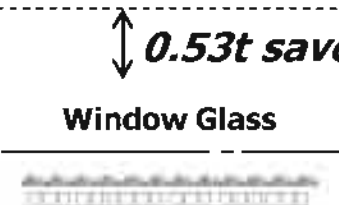

2.34t

	AMOLED	Super AMOLED	improvement
Thickness	2.87t	2.34t	0.53t down (no air gap)
Luminance	240cd/m <sup>2</sup>	300cd/m <sup>2</sup>	1.25 times up
Reflectance	16%	4%	1.3 times Visibility up

[ Structure Comparison ]

[ Spec Comparison ]

## 2. Sales Point – HW Performance

### *“Powerful Performance & Fast Speed”*

- ✓ **C111 : ARM CortexA8 1GHz, 89.5 M tri/s 3D Graphics**
- ✓ **WiFi b/g/n, HSUPA 5.76**
  - . WiFi-n : up to 75 Mbps, x2 wider range than WiFi-g

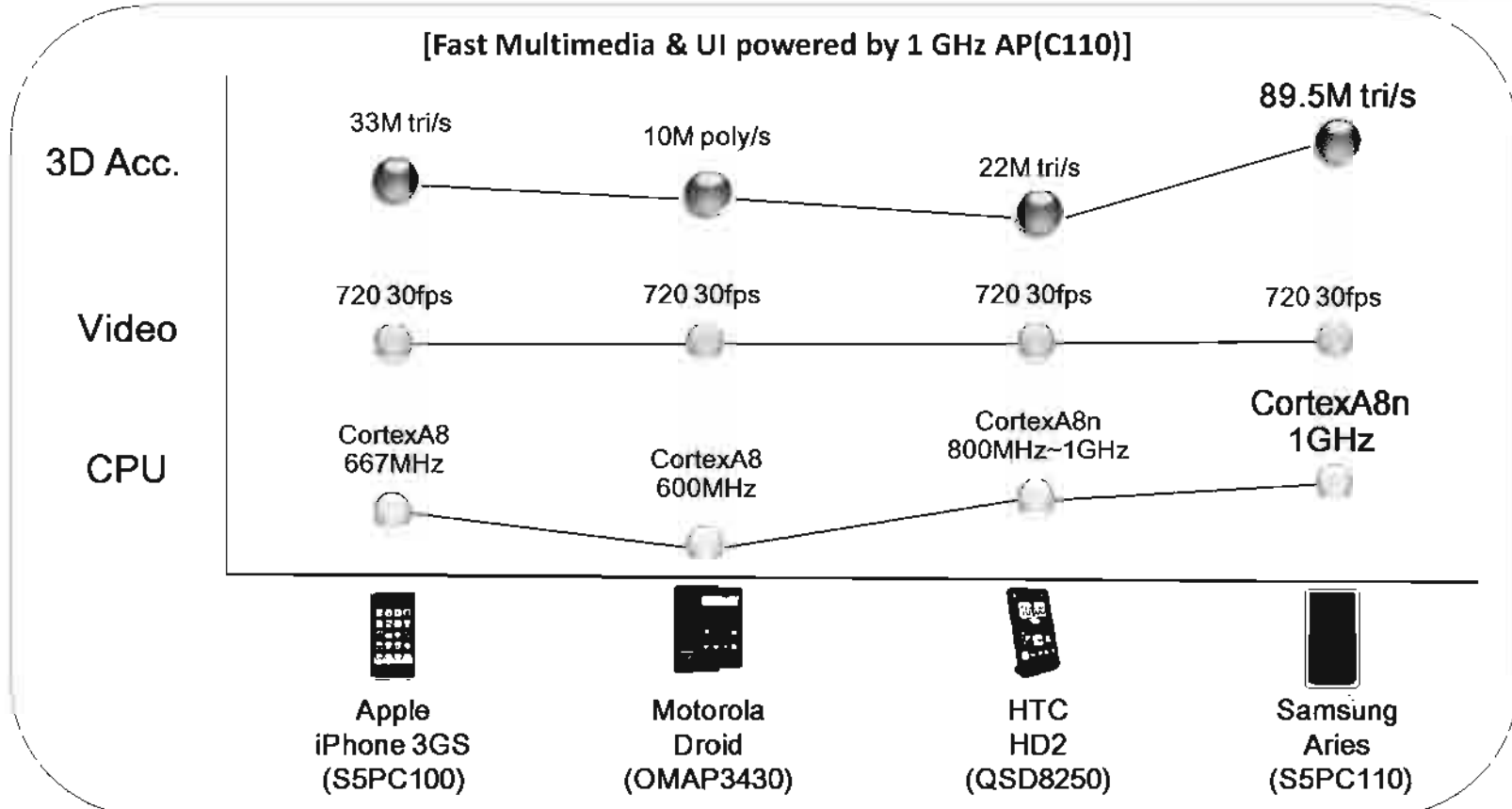

# 2. Sales Point - Multimedia

CONFIDENTIAL  
I

## "Maximized Multimedia Experience"

### ✓ Outstanding Multimedia & Entertainment

- HD (720p) Play & Recording, Video & Image Editor and Additional Music Info(Kies)
- Capacitive-type Multi-Touch Support
- First VT Camera for Android



[HD Play & Recording]

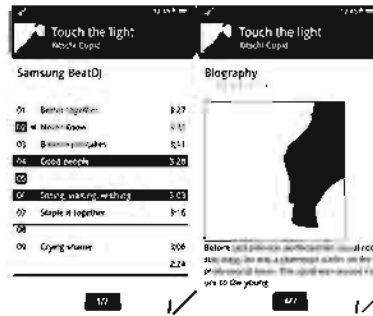

[Music Info by Samsung Kies]

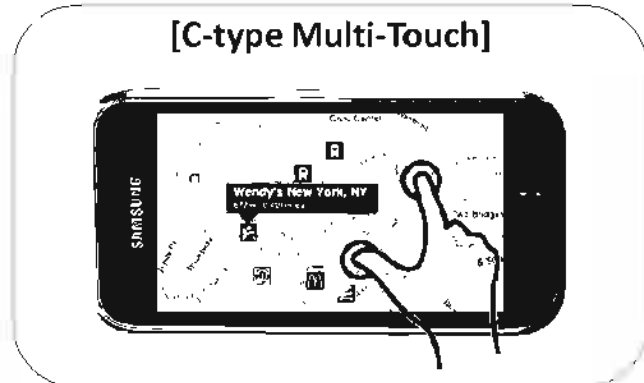

[C-type Multi-Touch]



[Video & Image Editor]

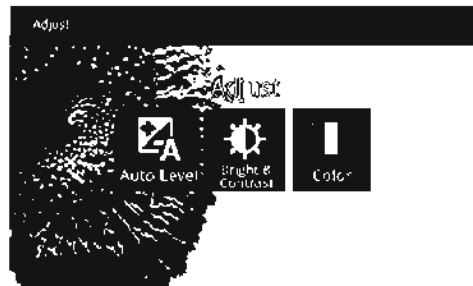

[VT camera for Android]

## 2. Sales Point – Social Hub

CONFIDENTIAL  
L

### *“Share Life Experiences While on the Go”*

- ✓ **Integrated Phonebook with SNS, IM, E-mail, SMS & MMS**  
- Immediate accessibility and interaction with SNS, IM, E-mail, SMS & MMS
- ✓ **Life Manager : Unified Calendar**



**[Contact with Updated Status]**  
- Unified view of SNS, IM, E-mail, SMS, MMS

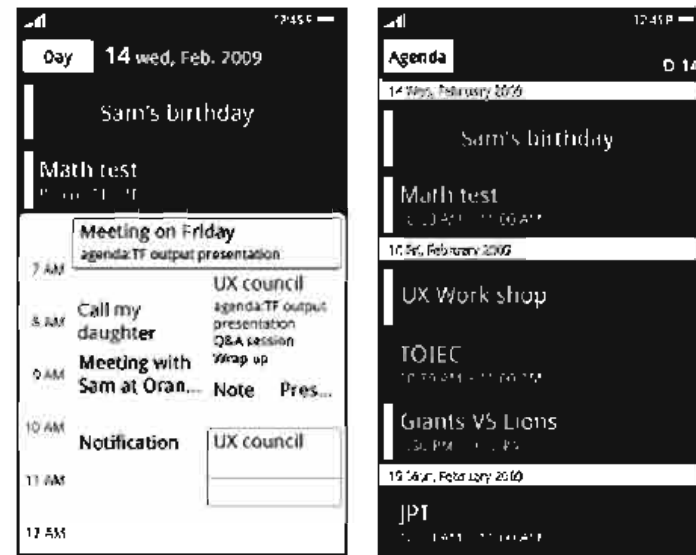

**[Multiple Calendar Integration]**  
- Integration of Google, Outlook & Facebook Calendar

# 2. Sales Point - Widgets

CONFIDENTIAL  
L

## “Hybrid Widgets to Create New Experiences”

- ✓ Up-to-date Information from Multiple Widgets
- ✓ Maximize Homescreen Experience through Various Information



[Hybrid Clock: Weather]



[Buddies Now]

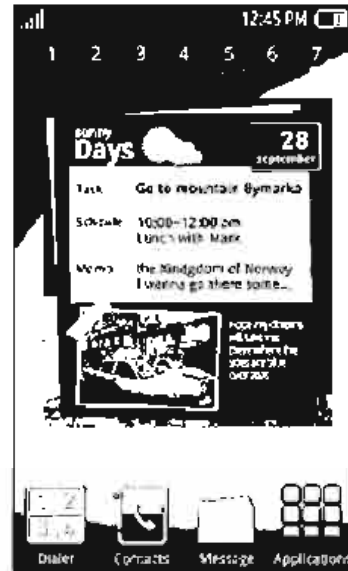

[Days]



[Daily Briefing]

## 2. Sales Point – Context-Aware

### *“Smart Life Enabler by Context-Awareness”*

- ✓ Customized & Evolved by Aggregating Behavior Patterns
- ✓ Always Your Smart & Friendly Companion

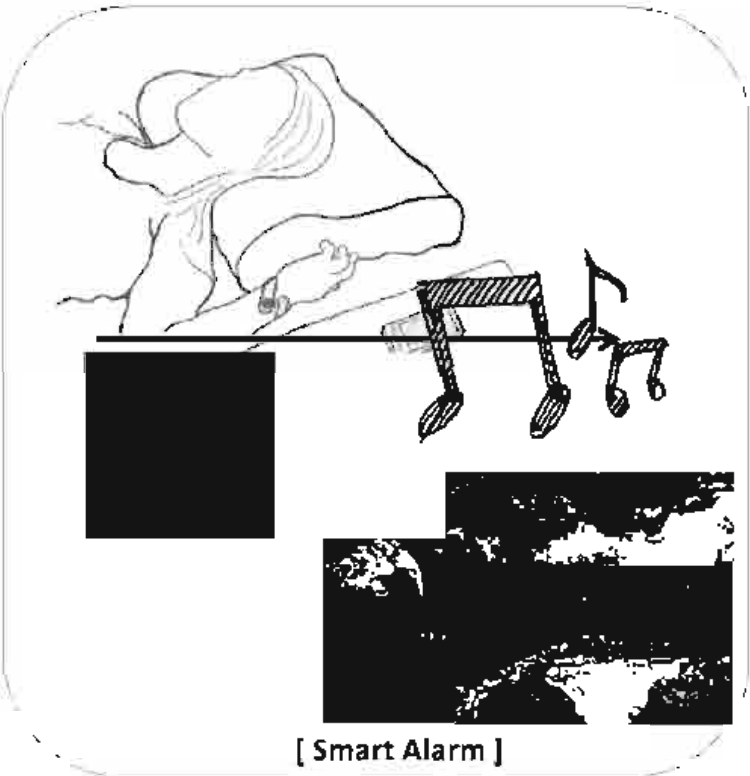
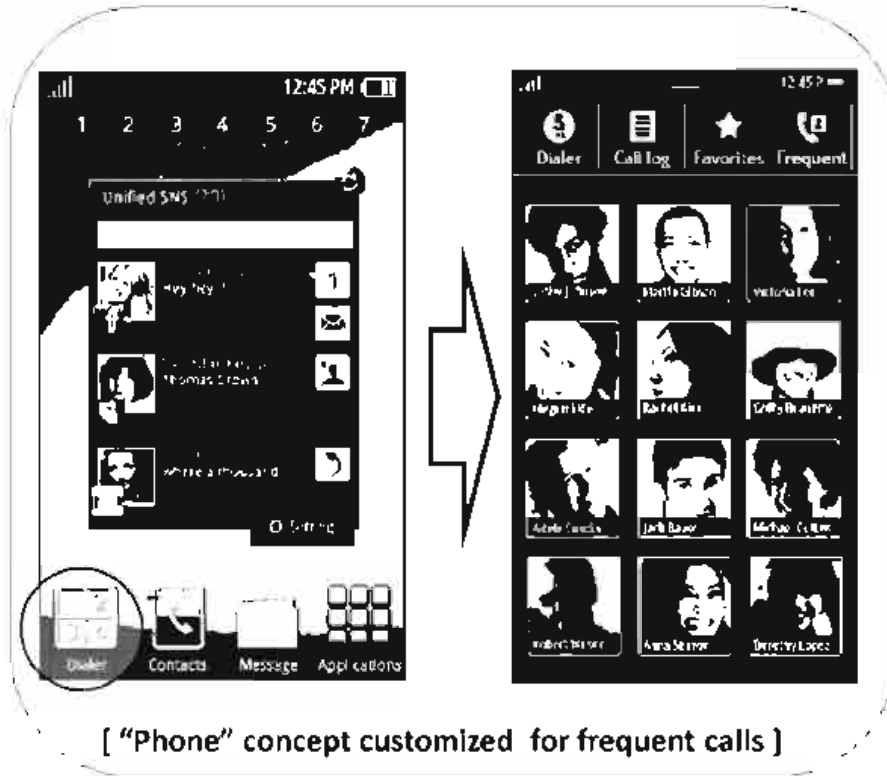



## 2. Sales Point – Augmented Reality

### *“Augmented Reality-based Social Browser”*

- ✓ Show User’s Surroundings & Display Information on Camera-view
- ✓ Global Core POI Information powered by Google Maps
  - Easy POI Search / More Accurate Search / Rich DB & Maintenance

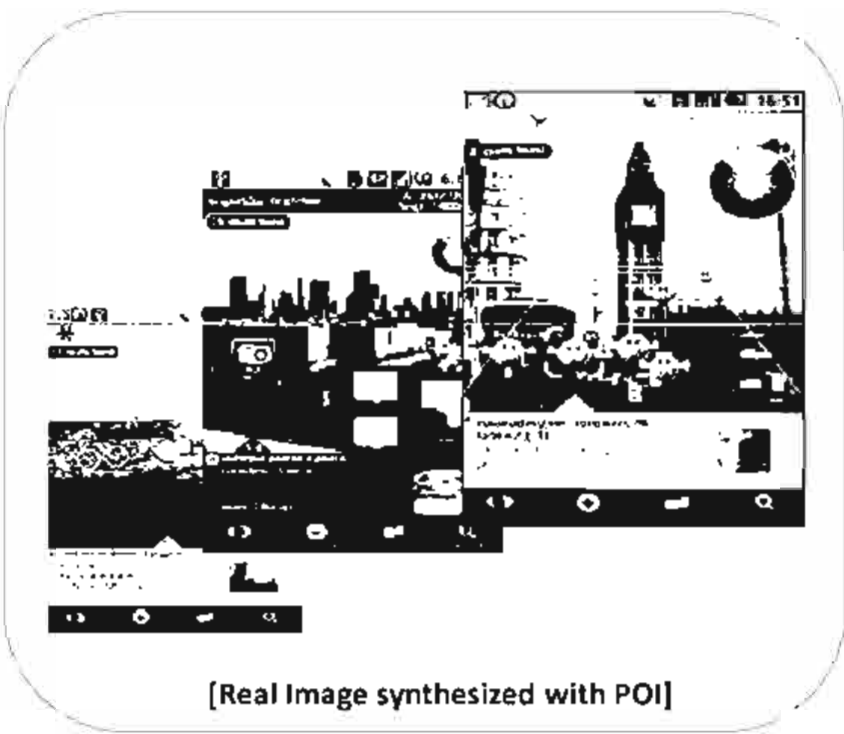

## 2. Sales Point - Convergence

### *“Center of Convergence with All-around Multimedia”*

- ✓ Easy & Convenient Convergence powered by DLNA (AllShare)

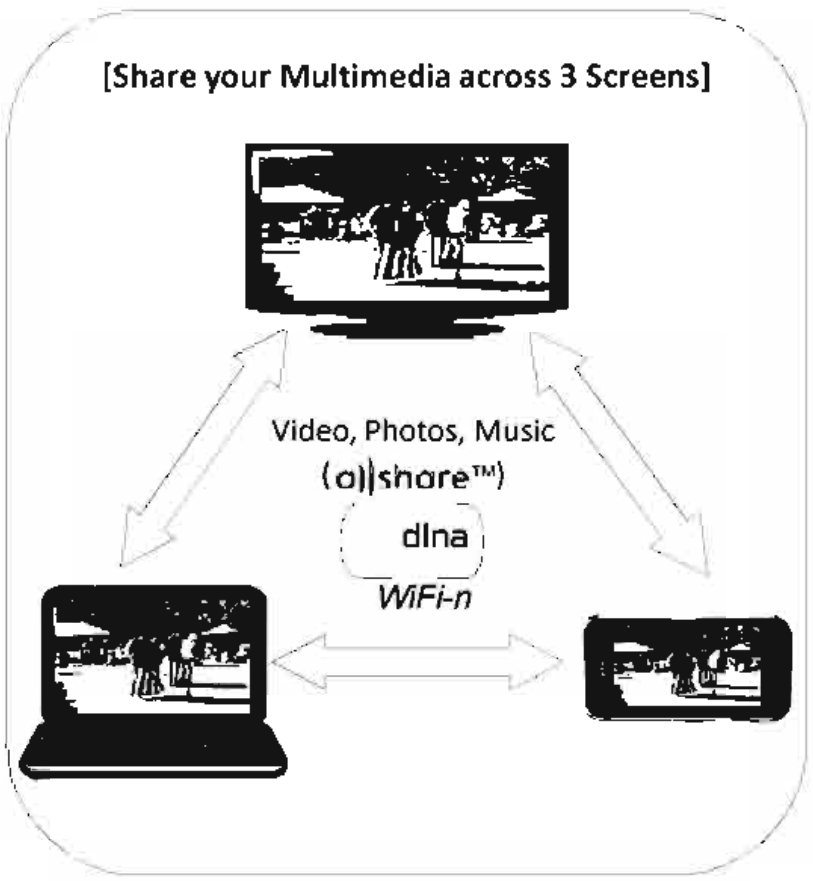

## 2. Sales Point - Advanced Features

CONFIDENTIAL  
L

### *“Fun Multimedia Experience”*

- Enhanced Camera Features for Perfect & Extraordinary Photos

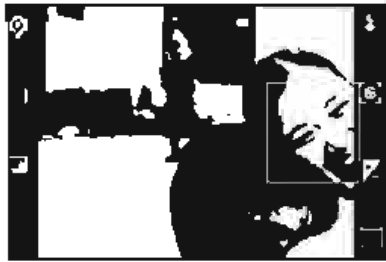

[Face Detection]



[Smile Recognition]



[Action shot]

### *“Smart Security”*



[Find Location]

- My Phone location on the map



[Remote Back-up & Remote Lock]

- Back-up my Data to Server  
- Lock or Wipeout my phone

### *“Expandable Connectivity”*

Media Management

Link to Web

#### Samsung Kies

Cross Device Support

DLNA

Contents Delivery Channel

#### [Samsung Kies]

- PC Studio for Contents Management

CONFIDENTIAL  
I

## 2. Sales Point – E-book

### “Best In-class Reading Experience”

- ✓ E-Book Experience optimized for 4.0” Large OCTA LCD
- ✓ Convenient & Customized for Reading Books
  - Customizable Themes, Easy Text search, and Intuitive Book list Management

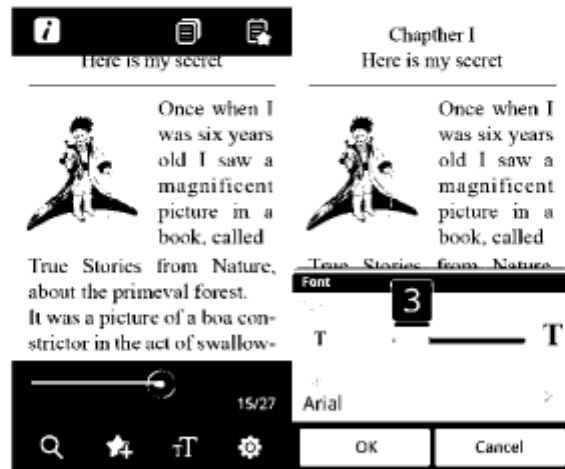

[ Customizable Themes ]

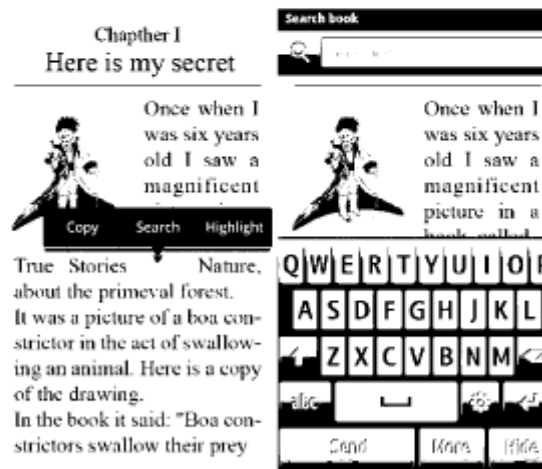

[ Easy Text Search ]

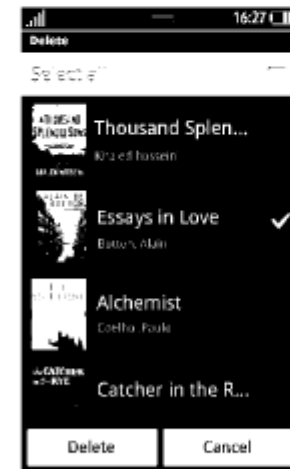

[ Book List ]

## 2. Sales Point – Aries-Q

### “Best Input Interface for Mobile Web”

- ✓ **Touch + QWERTY** : Most Preferred Input Interface of End-users
- ✓ **Optimized UX for QWERTY-slide**
  - Dedicated Key for “Write & Go”

#### Most Preferred Interface

Q. What's your perfect mobile input interface?

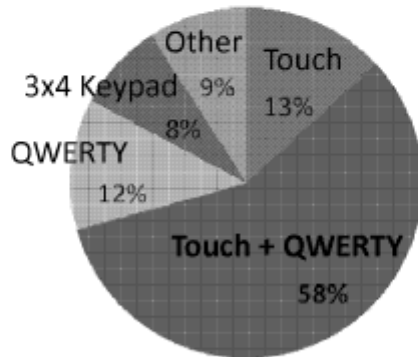

#### QWERTY Optimized UX

- **Dedicated Key for Write & Go**

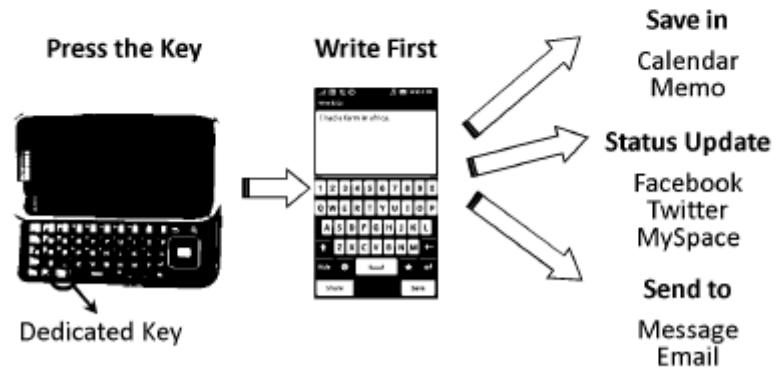

CONFIDENTIAL  
I

## 2. Sales Point - Accessories

### “Fully ranged Accessories”

- ✓ **A Variety of Accessories for Universal Multimedia Life**
  - Dedicated Accessories: External Battery, Projector, Navigation Kit

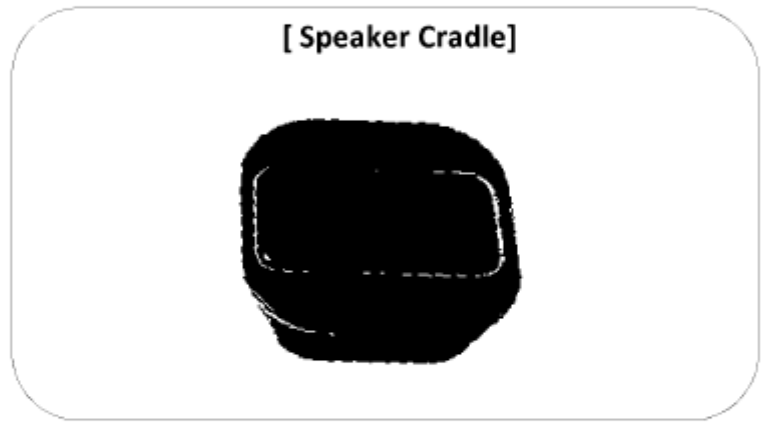
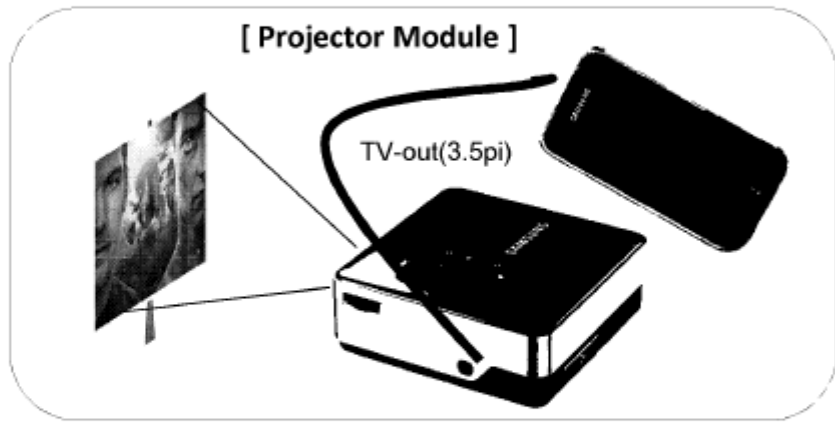



Acc.	Speaker Dock Cradle	External Battery Pack	Navigation Kit	Projector	Portable Dock Cradle
Image					
Spec.	Charger/Data Sync Int.Batt(1,500mAh)	4,000 mAh Micro USB * 2EA	Car Cradle Suction Holder Car Charger	WVGA(480x800) Composite 2*1W SPK,2000 mAh	Charger/Data Sync Portable, Slim 1,500 mAh

Confidential Business Information -- Subject to Protective Order

S-ITC-007849442

### 3. Competitor comparison



CONFIDENTIAL  
I

	Aries (S1) (GT-I9000)	NexusOne	iPhone 3G S
Design			
Launch	'10.05 (SRA Standard)	'10.01	'09.06
Price(T/P)	€380 (16GB) / €350 (8GB)	€379 (R/P Standard)	€465(16GB) / €535(32GB)
OS	Android Éclair 2.1	Android Éclair 2.1	iPhone OS 3.0
Processor	S5PC111 (1GHz)	QSD8250 (1GHz)	S5PC100 (600 MHz)
Dimension	64.2 x 122.4 x 9.9 mm, 118 g	59.8 x 119 x 11.9 mm, 130 g	62.1 x 115.5 x 12.3 mm, 135 g
Band	GSM (850/900/1800/1900) HSUPA5.76 (900/1900/2100)	GSM (850/900/1800/1900) HSDPA 7.2 (900/2100)	GSM (850/900/1800/1900) HSDPA 7.2 (850/1900/2100)
LCD	4.0" WVGA (480x800) On-Cell AMOELD	3.7" WVGA (480x800) AMOLED	3.5" HVGA (320x480) TFT
Touch Type	C-type	C-type	C-type
Camera + Flash	5MP AF w/o LED Flash	5MP AF w/ LED Flash	3MP AF w/o LED Flash
Battery	1500 mAh	1400 mAh	1200 mAh
Memory	4Gb+3Gb+1Gb / MovinAND 16GB microSD (upto 32GB)	4Gb + 4Gb / microSD 4GB microSD (upto 32GB)	4 Gb RAM / 16GB NAND Flash
Connectivity	BT 3.0, USB 2.0, GPS, WiFi 802.11 b/g/n microUSB, 3.5pi	BT 2.1, USB 2.0, GPS, WiFi 802.11 b/g microUSB, 3.5pi	BT 2.1, USB 2.0, GPS, WiFi 802.11 b/g microUSB, 3.5pi
Sensor	Accelerometer, Digital compass, Proximity, Light	Accelerometer, Digital compass, Proximity, Light	Accelerometer, Digital compass, Proximity, Light

### 3. Competitor comparison (Our Company)

CONFIDENTIAL

I

	Aries(S1) (GT-I9000)	Kessler	Lismore (GT-S8500)
<b>Design</b>			
<b>Launch</b>	'10.05	'10.09	'10.04
<b>Price(T/P)</b>	€ 380	€ 380	€ 245
<b>OS</b>	Android Éclair 2.1	LiMo (Linux OS 2.6.29)	bada
<b>Processor</b>	S5PC111	S5PC111	S5PC111
<b>Dimension</b>	64.2 x 122.4 x 9.9 mm	66.9 x 124.8 x 9.9 mm	118 x 56 x 10.9 mm
<b>Band</b>	GSM (850/900/1800/1900) HSUPA 5.76 (900/1900/2100)	GSM (850/900/1800/1900) HSUPA 5.76 (900/1900/2100)	GSM (850/900/1800/1900) HSDPA 3.6 (900/2100)
<b>LCD</b>	4.0" WVGA (480x800) On-Cell AMOLED	4.3" WVGA (800x480) On-Cell AMOLED	3.3" WVGA (480x800) On-Cell AMOLED (Curved Glass)
<b>Touch Type</b>	C-type	C-type	C-type
<b>Camera + Flash</b>	5MP AF w/o LED Flash	5MP AF w/o LED Flash	5MP AF w/ LED Flash
<b>Battery</b>	1500 mAh	1500 mAh	1500 mAh
<b>Memory</b>	4Gb+3Gb+1GB / MoviNAND 16GB microSD(up to 32GB)	4Gb+3Gb+1GB / MoviNAND 16GB microSD(up to 32GB)	4Gb+2Gb+1GB / MoviNAND 8GB microSD(up to 32GB)
<b>Connectivity</b>	BT 3.0, USB 2.0, WiFi 802.11 b/g/n	BT 3.0, USB 2.0, WiFi 802.11 b/g/n	BT 3.0, USB 2.0, WiFi 802.11 b/g/n
<b>Sensor</b>	Accelerometer, Light, Proximity, Digital compass	Accelerometer, Light, Proximity, Digital compass	Accelerometer, Light, Proximity, Digital compass
<b>Video</b>	720p@30fps, DivX/XviD	720p@30fps, DivX/XviD	720p@30fps, DivX/XviD



4-1. Evaluation – Aries	CONFIDENTIAL
-------------------------	--------------

Design Evaluation Result	8.1 (Acceptable)
--------------------------	------------------

Category	Evaluation Result		Remarks
Exterior Design	8	Appropriate	<ul style="list-style-type: none"> <li>A new change tried by applying the curved glass on the lower front.</li> <li>Applying to the lower backside a curve with the opposite value from that of the front created a connected feel and a better grip feel, and protects the surface when laid down.</li> </ul>
Color/Material	8	Appropriate	<ul style="list-style-type: none"> <li>Added luxurious feel by applying the metal edge to the simple black body</li> </ul>
Usability	8.2	Appropriate	<ul style="list-style-type: none"> <li>Very slim for its size, and the key operation is highly stable.</li> </ul>

Problems/Issues	Solutions
<ul style="list-style-type: none"> <li>No hanger hole, camera key, flash, or mirror</li> <li>Need to mark high/low division on the volume key – imprint or apply separated high/low keys (refer to the Samsung Standard Proposal)</li> </ul>	<ul style="list-style-type: none"> <li>Hanger hole to be added; camera key/flash/mirror are strategically removed for the competitiveness in design and size (confirmed by the Head of the Division on 1/19)</li> <li>High/low division to be marked on the volume key</li> </ul>

CONFIDENTIAL  
I

# 4-1. Evaluation – Aries-Q

Design Evaluation Results	8.0 (Appropriate)
---------------------------	-------------------

Category	Evaluation Result		Remarks
Exterior Design	8	Appropriate	<ul style="list-style-type: none"> <li>▶ A new change tried by applying the curved glass on the lower front.</li> <li>▶ Applying to the lower backside a curve with the opposite value from that of the front created a connected feel and a better grip feel, and protects the surface when laid down.</li> <li>▶ Samsung logo on the front and the back seems a bit small.</li> </ul>
Color//Material	8	Appropriate	<ul style="list-style-type: none"> <li>▶ Added luxurious feel through the balanced application of the metal edge to the simple black body</li> <li>▶ Luxurious feel by using the appropriate contrast of gloss and matte</li> </ul>
Usability	8	Appropriate	<ul style="list-style-type: none"> <li>▶ Very slim for its size; due to the curve at the bottom, high stability during front surface/QWERTY key usage</li> </ul>

Problems/Issues	Fix Action
<ul style="list-style-type: none"> <li>▶ No hanger hole, camera key, flash, or mirror</li>   <li>▶ Need to mark high/low division on the volume key – imprint or apply separated high/low keys (refer to the Samsung Standard Proposal)</li> </ul>	<ul style="list-style-type: none"> <li>▶ Hanger hole to be added; camera key/flash/mirror are strategically removed for the competitiveness in design and size (confirmed by the Head of the Division on 1/19)</li>   <li>▶ High/low division to be marked on the volume key</li> </ul>

~~CONFIDENTIAL~~  
L

## 4-2. Evaluation (Feature) – Aries

Confidential Business Information -- Subject to Protective Order

Feature Evaluation Results		<b>8.44 (+21.9%)</b>
Model that is Compared Against		<b>iPhone 3GS</b>
<b>Image</b>		
Detailed Evaluation Results		Remarks
Superior Items	19	Instant Messenger, WAP browser, Changeable covers, Camera resolution, Camera extra features, Video resolution, BT version, BT profile, WiFi extra features, Display type/resolution/diagonal, Audio codec, FM radio, Memory card slot/max capa, JAVA, Games, In-box acc.
Inferior Items	1	Multi-language

Problems/Issues	Solutions
- Multi-language	Aries (14 languages, Samsung XT9 Keyboard standard) is currently inferior to iPhone (30 languages), but in process of developing 15 additional Locales, and to review consequent expansion

S-ITC-007849447

# 4-3. Evaluation (Service) – Aries

Confidential Business Information -- Subject to Protective Order

Service Evaluation Results		8.2 (▲10%)
Comparison Target Model		iPhone 3GS
Image		
Detailed Evaluation Results		Remarks
Superior Items	5	Superior: SNS, IM, Widget, Kies Equal: Video, E-book
Inferior Items	2	Photo-upload Application, Android Market
Problems/Issues		Solutions
Android Market is inferior compared to Appstore		<ul style="list-style-type: none"> <li>1) Google plans to have a Global Promotion of the Android Market in the second quarter of 2010</li> <li>2) Respond to the Needs of Local consumers by loading More Widgets that will allow Samsung to be distinguished</li> <li>3) In countries where the Android Market is not available, load Slideme to provide a Marketplace in place of the Android Market.</li> </ul>

S-ITC-007849448

CONFIDENTIAL  
I

# 5-1. H/W Spec.

Confidential Business Information -- Subject to Protective Order

S-ITC-007849449

Category	Description
B/B Chipset	IFX6160
Standard	HSUPA 5.76 Mbps, HSDPA 7.2 Mbps EDGE/GPRS Class 12
RF Band	Tri band UMTS 900/1900/2100 Quad band GSM 850/900/1800/1900
Additional Chip	S5PC111 (1GHz)
Dimension	Aries: 64.2 x 122.4 x 9.9 mm Aries-Q: 64.2 x 126 x 13.5 mm (Manual, PK)
Display	4.0" WVGA On-Cell AMOLED, C-type touch
Camera	5M AF
Flash	N/A
Memory	4Gb+3Gb+1Gb, 16GB MovinAND
Ex. Memory	microSD (upto 32GB)
Antenna	Integrated Antenna
SIM	Sliding Type, 3V Only

Category	Description
Battery	Li-polymer 1500mAh
- STD time	250H (@PP2)
- Talk time	5H (@PL5)
Connectivity	WiFi 802.11 b/g/n USB 2.0 H/S BT v3.0
IF Connector	microUSB
Speaker	Size : 1115 SPK/RCV : Separated type 12x07 Resonance Space: 0.625 cc Volume Standard: Reliability 65dB
Ear Jack	Φ3.5 4-Pole
CMF	Front : Reinforced glass Rear : PC molding Main Color : Noble Black
VPS	Package : Batt., Manual, TA, Earphone etc Option : Car charger, BT headset, Data cable
User Benefit	- 4.0" Large Super AMOLED optimized for Enhanced Outdoor Visibility & HD Experience - 9.9t Ultra Slim for Comfortable Hand Grip - Large 1500 mAh Batt. for Long Multimedia Experience

## 5-2. S/W Spec.

Category	Description
OS	Android Éclair 2.1
Message	SMS / MMS(OMA v 1.2) E-mail (POP3/IMAP/SMTP) Exchange ActiveSync E-mail (Push e-mail)
Codec	- Audio : MP3, OGG, AAC, AAC+, eAAC+, AMR-NB, WMA, WAV, MID, AC3, IMY, AAC(Mono), AMR_NB -Video : . Codec: Mpeg4, H.264, H.263, H263Sorenson, Divx/XviD, VC-1 . Format: 3gp(mp4), wmv(asf), avi(divx), mkv, flv Image : JPEG, PNG, GIF, WBMP, BMP, AGIF
WAP	No support of WAP in android Chrome Lite Browser, HTML 5.0 HTTP, OTA provisioning supported
GPS	A-GPS (Supports SUPL)
JAVA (JSR's)	Variably applied depending on the carrier's request
DRM	OMA DRM 1.0 Full (FL, CD, SD), WMDRM/ MTP (SEUK Spec)

Category	Description
Bluetooth	<ul style="list-style-type: none"> <li>▪ Bluetooth v3.0</li> <li>▪ Profile : GAP, SSP, SDAP, HSP, HFP1.5, A2DP, AVRCP, SPP, DUN, FTP, SAP, BPP, OPP, PBAP</li> </ul>
SyncML	MS Outlook Exchangeable SyncML DS v1.2, SyncML DM v1.2, FOTA
Others	<ul style="list-style-type: none"> <li>▪ TouchWiz 3.0</li> <li>. Homescreen, Hybrid Widgets</li> <li>▪ Integrated Messaging</li> <li>▪ Google Mobile Services</li> <li>▪ Kies, DLNA, FM Radio</li> <li>▪ Media Browser, Photo Editor, Write &amp; Go</li> </ul>
User Benefit	<ul style="list-style-type: none"> <li>▪ TouchWiz 3.0 UX</li> <li>. 7 home screens &amp; editable menu</li> <li>. Hybrid widgets</li> <li>▪ Stay connected with friends in real time</li> <li>. Integrated Contact with SNS, IM, Email</li> <li>▪ Sync with PC, Mobile and Social Event</li> <li>. Integrated Calendar</li> <li>▪ Push Service (SNS, Email, IM)</li> <li>▪ Easy Photo Management with Media Browser</li> <li>▪ VT Call for Android</li> </ul>

## 5-2. S/W Spec.( Features with License Payments)

<b>Planned Applications</b>		
<b>Type</b>	<b>Category Guide (52 Types)</b>	<b>Planned Applications (13 Types)</b>
<b>Basic Features</b>	Pocket PC/Smartphone, MS Active Sync, MMV, QVM, MPEG-2 SYSTEM H.264 AVC, JAVA, Vsuite, Global Map, NDIS, MTP/PTP/DFU, SS, Smile/blink Detection, ArcSoft Video Editor, Codec package Audio amp, 3D graphic Flashplayer, vibration solution, Browser DIVIX, Music ID( sound source recognition), Media Player, Aricent(Emuzod), UMA-compliant moWLAN Navigation S/W, Kastor Engine, Rich media, Open SVG solution, video edit, Dataviz Activesync, 3D sound/ bass boost, USB Driver, EA game title SyncML/ FOTA WAP Browser, Caps Engine, Digital Bridges game title Caps Engine, AlexVG Engine/Player ARICENT video codec OMA DRM, Photo Slides / Zoomer, Flashplayer, UMA-compliant MoWLAN Localization, Steam house game contents, MBX Core (3D Graphic Accelerator), o photo, DRM / JAVA / Music / Video Game(Asphalt4), Russian recognition and dictionary capability	MPEG-2 System, H.264 AVC, JAVA, Vsuite, Smile/Blink Detection, JTEK, Flashplayer, Vibration solution, video CODEC, document viewer, editor SyncML/FOTA, Caps Engine, AlexVG Engine/player
<b>New/Additional Features</b>		Layar, Evernote, Flipfont, Bump

<b>New/Additional Features</b>		
<b>New/Additional Features</b>	<b>Feature Summary</b>	<b>Reason for Application</b>
Layar	Augmented Reality browser	- Favorable local consumer response when installed on Galaxy
Evernote	Web-based Note	- Enhance User note function
Flipfont	Font Change	- Font change differentiation for Android possible
Bump	Business card exchange function	- Fun function

TRANSLATION

Planned Applications	Category Guide (52 Types)	Planned Applications (13 Types)
Type		
<p><b>New/Additional Features</b></p>	<p><b>Basic Features</b></p> <p>Pocket PC/Smartphone: MS Active Sync (MVC/2MVC), MPEG-2 SYSTEM H.264 AVC, JAVA, Vsuite, Global Key, MIDX, H.264 AVC, JAVA, Vsuite, Global Key, MIDX, Editor, Code Editor, Document Editor, Audio/Video, Audio email, 3gp, quiet, Ringtone, vibration solution, Browser, DIVX, Music, IC, sound source recognition, Modem Player, Microsoft, UML-complement, LAN, Navigation, S/W, Kalendar, Expense, Zonemedia, Open, SVG solution, VNC, etc.,</p> <p>Development: 3D, Serial, Boss, 0099, USB, Driver, Diagnose, the, SyncML, FOTA, VMAP, browser, Code Engine, Digital, Badges, game, file, Caps Engine, Always, Engine/Player, ARKENT, video, CODE, OMA, DHTML, photo, Silder / Zoom, Flip/Player, UML-complement, MOV, LAN, Localization, System, touch, game, contents, MSX, Code (3D, Graphic, Acceleration, to, protocol, DHTML, JAVA, Basic, Video, Genet/Flash, Kalendar, reservation, and, dictionary, capability</p>	<p>MPEG-2 System, H.264 AVC, JAVA, Vsuite, Smile/Blink Delection, JTEK, Flashplayer, Vibration solution, video CODEC, document viewer, editor</p> <p>SyncML/FOTA, Caps Engine, AlexV/S Engine/Player</p>
<p><b>New/Additional Features</b></p>	<p>Layer, Evernote, Flipfont, Bump</p>	
New/Additional Features	Feature Summary	Reason for Application
<p><b>New/Additional Features</b></p>	<p>Layer</p> <p>Evernote</p> <p>Flipfont</p> <p>Bump</p>	<p>• Favorable local consumer response when installed on Galaxy</p> <p>- Enhance User note function</p> <p>- Font change differentiation for Android possible</p> <p>- Fun function</p>
	<p>Augmented Reality browser</p> <p>Web-based Note</p> <p>Font Change</p> <p>Business card exchange function</p>	

NDIS: ACM Modem Driver/NDIS Driver for MAC PC



# 5-4. UX RELATED

## PLANNED ARIES UX APPLICATION

### DISTINGUISHING POINTS

### Basic

1. Android OS UI Based :Basic component, pop-up, settings, wireless controls
2. Apply Samsung TouchWiz 3.0 UI

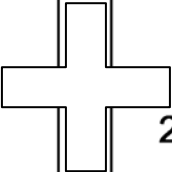

### New features

1. Enhanced SNS UX
  - Support integrated phonebook & Calendar
  - Add Online album to the Media browser
  - Support push event (Email, SNS activities), Support IM
2. New widgets
  - Buddies now, hybrid clocks, Daily briefing ...
3. Add Additional Features
  - Multi-media UX for a fun (Add me, Action shot, Stop motion), Write & Go

Confidential

# 5-4. UX RELATED

## New Features

### 1. Enhanced SNS UX



### 2. New widgets

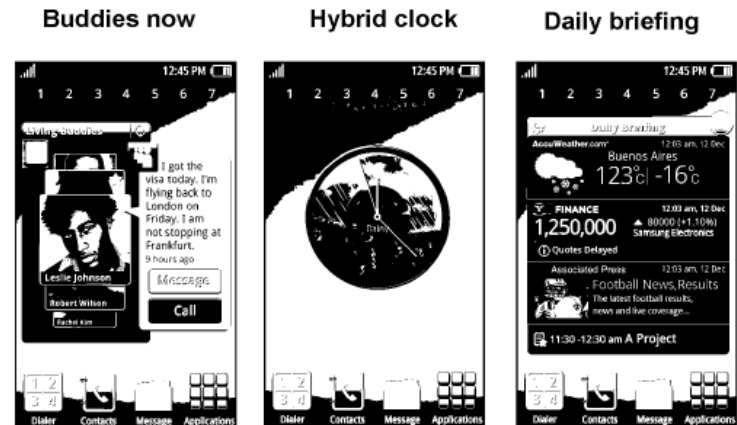

### 3. Distinguishing the Additional Features

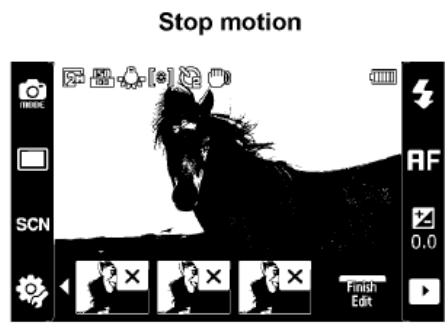
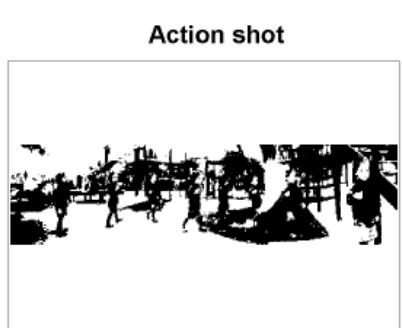



Confidential Business Information -- Subject to Protective Order

S-ITC-007849454



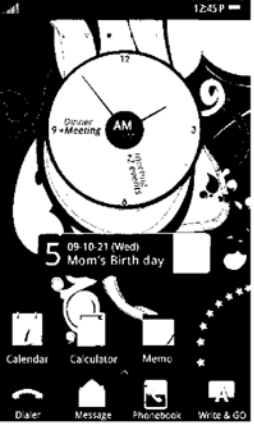

# 5-4. Service Spec.

CONFIDENTIAL

Category		Description
Widget for Android	2.5	<p><b>Hybrid Widgets</b></p> <ul style="list-style-type: none"> <li>- Display Multiple Information on single Widget</li> <li>- Hybrid Clock (Clock + Weather, Finance, Calendar)</li> <li>- Daily Brief (Alarm + Weather, News, Stock...)</li> <li>- Days (Photo diary on my hand)</li> </ul> <p><b>eRobert Parker</b></p> <ul style="list-style-type: none"> <li>- World famous wine vintage guide</li> </ul>
		<div style="display: flex; justify-content: space-around;"> <div style="text-align: center;">  <p><b>Hybrid Clock</b></p> </div> <div style="text-align: center;">  <p><b>Daily Brief</b></p> </div> <div style="text-align: center;">  <p><b>eRobert Parker</b></p> </div> </div> <div style="text-align: center; margin-top: 10px;">  <p><b>Days</b></p> </div> <p style="text-align: right; margin-top: 10px;">* UI screenshot may change</p>

# 5-4. Service Spec. (Cont'd)

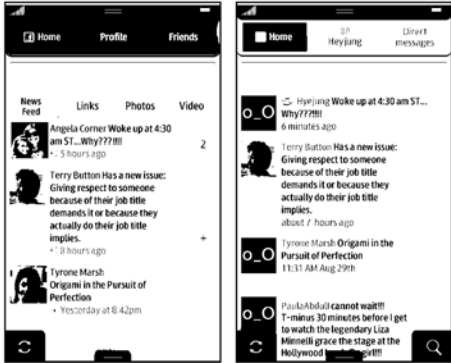
CONFIDENTIAL

Category	Description
<p>SNS</p> <p>4.0</p>	<p><b>Phonebook integration</b></p> <ul style="list-style-type: none"> <li>-User can check SNS feeds on the phonebook and comment on them directly from the phonebook.</li> <li>-Person-centric network/communication service will be provided on an application.</li> </ul> <p><b>Unified feeds and update</b></p> <ul style="list-style-type: none"> <li>- Multiple SNS on single widget (Facebook, Twitter, MySpace)</li> <li>- Display feeds and update my status on single widget</li> </ul> <div style="display: flex; justify-content: space-around; align-items: center;"> <div style="text-align: center;">   </div> <div style="text-align: center;">  <p>Phonebook Integration</p> </div> <div style="text-align: center;">  <p>SNS Applications</p> </div> </div> <div style="text-align: center; margin-top: 20px;">  <p>SNS Widgets</p> </div> <p style="text-align: right; font-size: small;">* UI screenshot may change</p>

# 5-4. Service Spec. (Cont'd)









CONFIDENTIAL

Category	Description
<p align="center"><b>Calendar Integration</b></p>	<p><b>Social Calendar</b></p> <ul style="list-style-type: none"> <li>- Real-time 2 way sync with Google and Yahoo</li> <li>- Get event from facebook</li> <li>- Supporting EAS calendar sync feature</li> <li>- Calendar 1.0 + facebook, Yahoo, Google</li> </ul> <div data-bbox="1239 552 1806 812" style="border: 1px solid black; border-radius: 15px; padding: 10px; margin: 10px 0;"> </div> <div data-bbox="672 828 1764 1299" style="border: 1px solid black; padding: 10px; margin: 10px 0;"> <p align="center"> <span>Month view</span>      <span>List view</span>      <span>Detail view</span>      <span>Create Event</span> </p> </div> <p align="right">* UI screenshot may change</p>

CONFIDENTIAL  
I

# 5-4. Service Spec. (Cont'd)

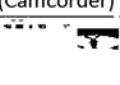
Confidential Business Information -- Subject to Protective Order

Category	Description
Kies 1.5	<ul style="list-style-type: none"> <li>- Samsung Kies is an integration PC SW for Samsung Digital Devices</li> <li>- Easy Data Backup/Sync, Contents Management</li> <li>- Contents Delivery Channel (Music/Video/Application)</li> <li>- Cross-Device Content Share through DLNA</li> <li>- User Beneficial Features</li> <li>- PC : Support Windows XP/Vista/7</li> </ul> <div style="text-align: center;"> <p><b>PC SW for Mobile handset</b></p> <div style="display: flex; justify-content: space-around;"> <div style="text-align: center;"> <p>PC Studio (GSM)</p>  </div> <div style="text-align: center;"> <p>PC Link, PMP (CDMA)</p>  </div> <div style="text-align: center;"> <p>PC Manager</p>  </div> <div style="text-align: center;"> <p>NPS (HHP)</p>  </div> </div> <p><b>PC SW for digital device</b></p> <div style="display: flex; justify-content: space-around;"> <div style="text-align: center;"> <p>EmoDio (MP3P)</p>  </div> <div style="text-align: center;"> <p>Samsung Master(DSC)</p>  </div> <div style="text-align: center;"> <p>Cyberlink (Camcorder)</p>  </div> <div style="text-align: center;"> <p>AV Station (PC)</p>  </div> </div> <div style="text-align: right; margin-top: 20px;"> <p><b>Samsung kies</b></p>  <ul style="list-style-type: none"> <li>- Integrate PC SW</li> <li>- Improve usability with user-friendly interface</li> </ul> </div> </div>

S-ITC-007849459

# 5-5. CMF Spec. – Aries-Q

Confidential Business Information -- Subject to Protective Order

S-ITC-007849461

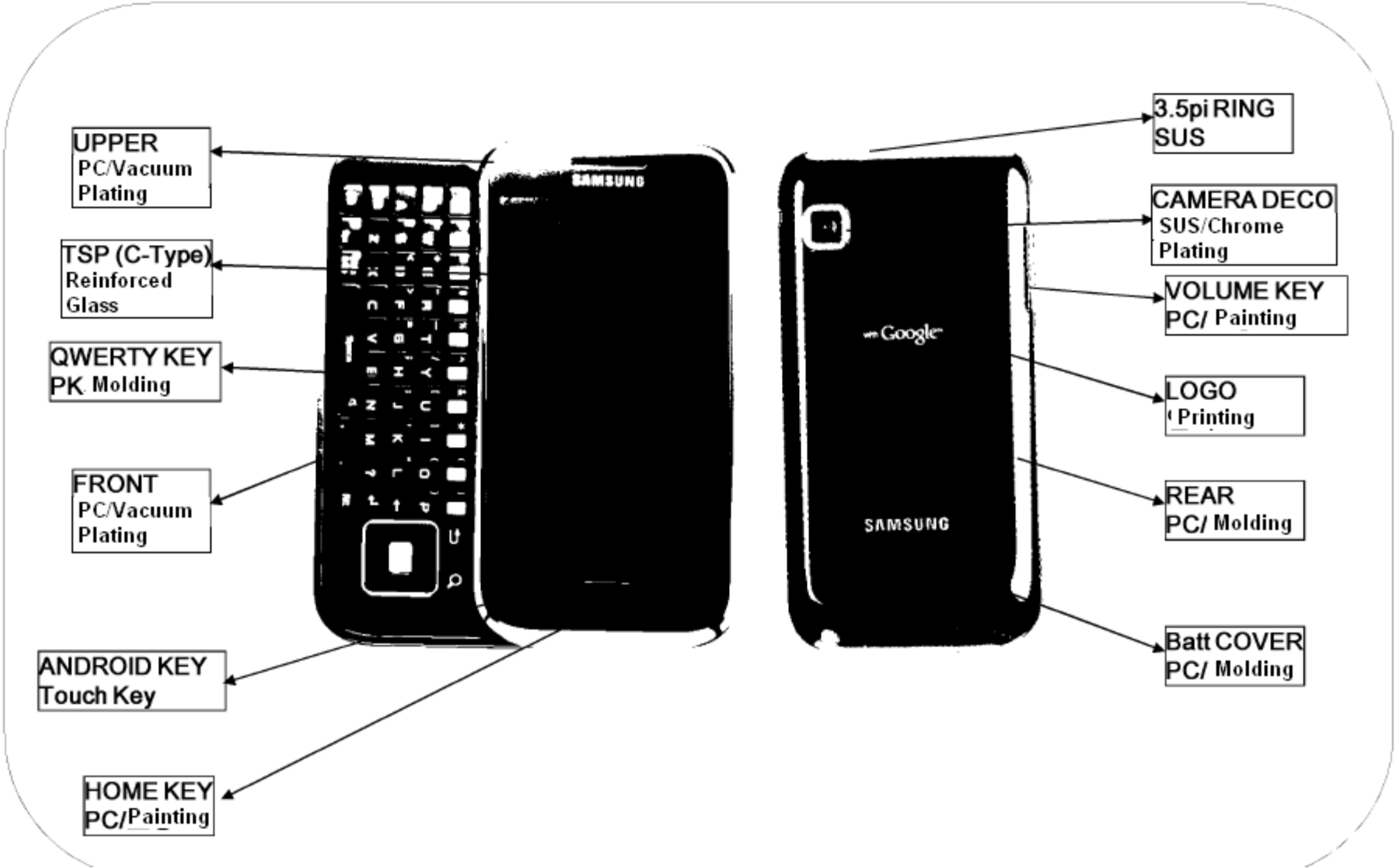

## 5-6. Project Review Checklist













Presentation of the Development PL

- Presentation focused on main issues



CONFIDENTIAL

## 6. VPS

	Item	Spec.	Image	Remark	Material Cost	Sale Price (Target)
Package	Standard Battery	Li-Polymer, 1500mA		Common	\$3.31	
	Manual (Quick guide+Manual)	- User guide - PC Suite user guide - CD Installer		English 1EA	\$0.30	
	Travel Adapter	microUSB		Common	\$1.14	
	Earphone	EHS60 In-canal Stereo 3.5mm 4p, Mini Mic		Common	\$1.25	
	Data Cable	microUSB		Common	\$0.40	
Option	B/T Headset (Mono)	HM3100		Common	-	\$49.9
	B/T Headset (Stereo)	SBH650		Common	-	\$89.9
	Wired Speaker	SP100 2 * 2 Watt		Common	-	\$29.9
	Speaker Dock Cradle	2 * 1 Watt 1,500 mAh		Dedicated	-	\$45.9
	Portable Dock Cradle	1,500 mAh		Dedicated	-	\$34.9
	Navigation Kit	- Car Cradle - Suction Holder - CLA		Dedicated	-	\$44.9
	External Battery Pack	4,000 mAh Micro USB		Common	-	\$69.9
	Mobile Beam Projector	MBP110 WVGA(854*480) 2,000mAh, TV-out & HDMI		Common	-	\$249.9

CONFIDENTIAL  
I

# 7. Target Sales Volume, Price and Profit

Aries

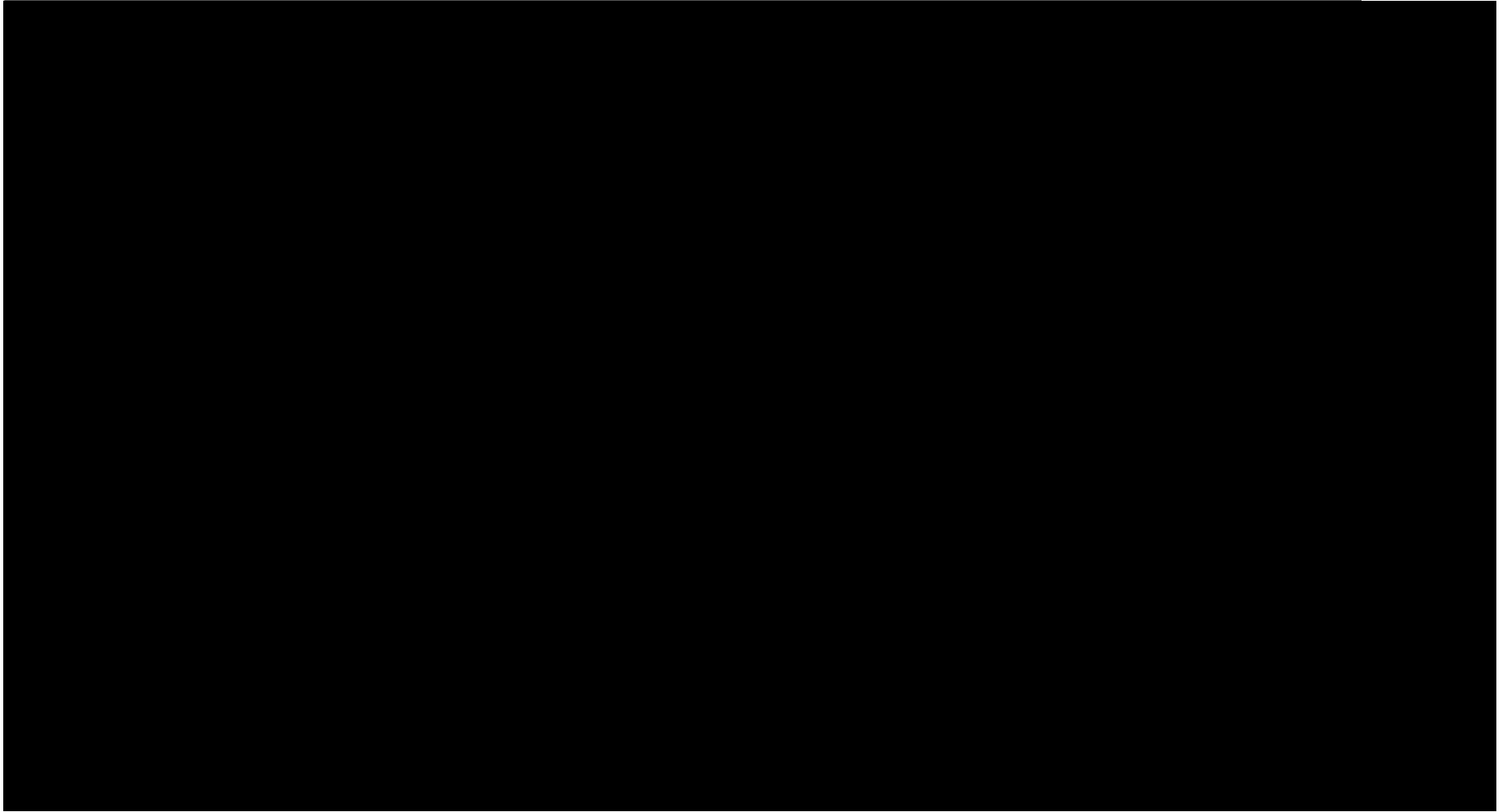

CONFIDENTIAL  
I

# 7. Target Sales Volume, Price and Profit

Aries-Q

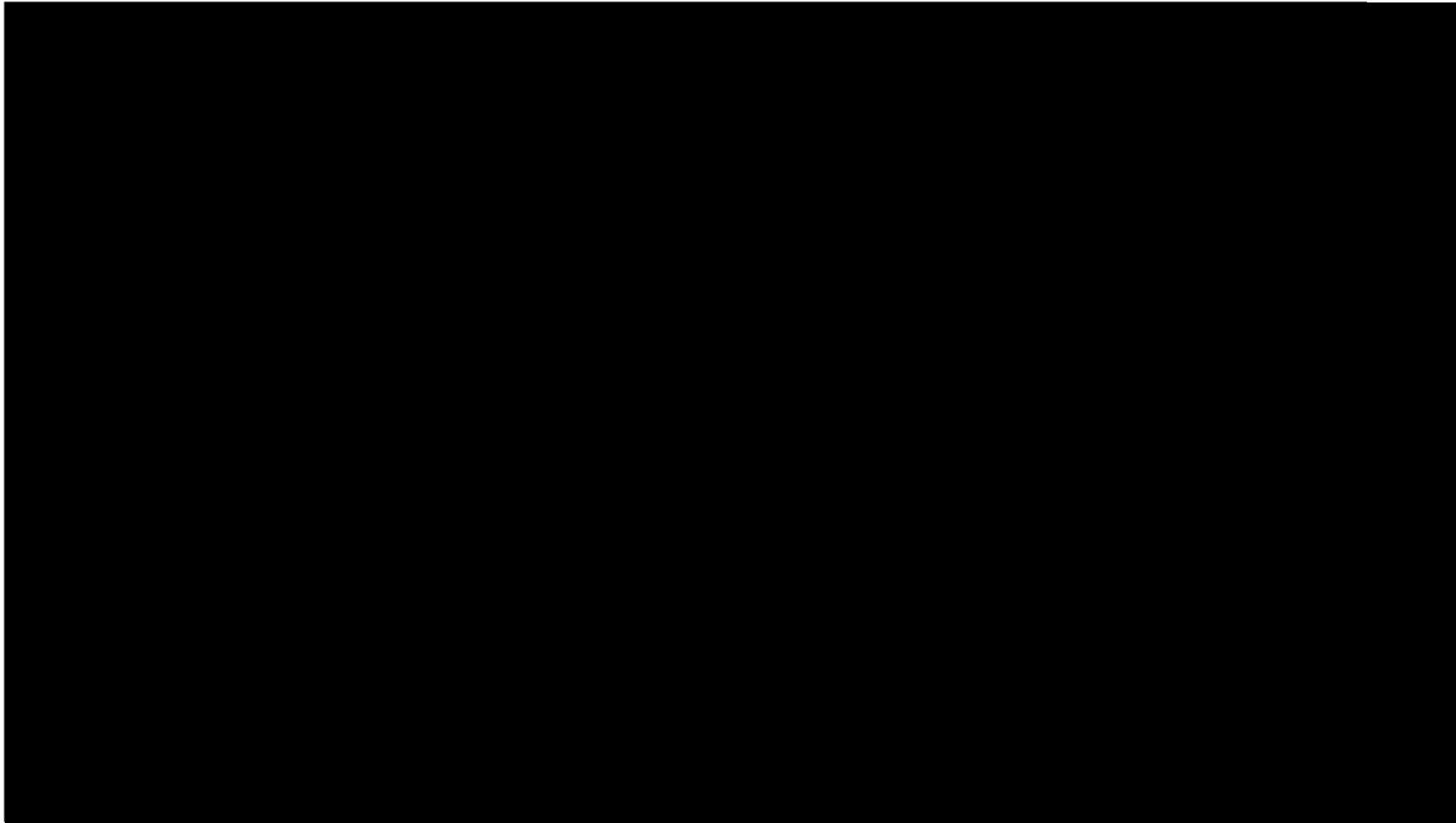

## 8. PLC (Aries)

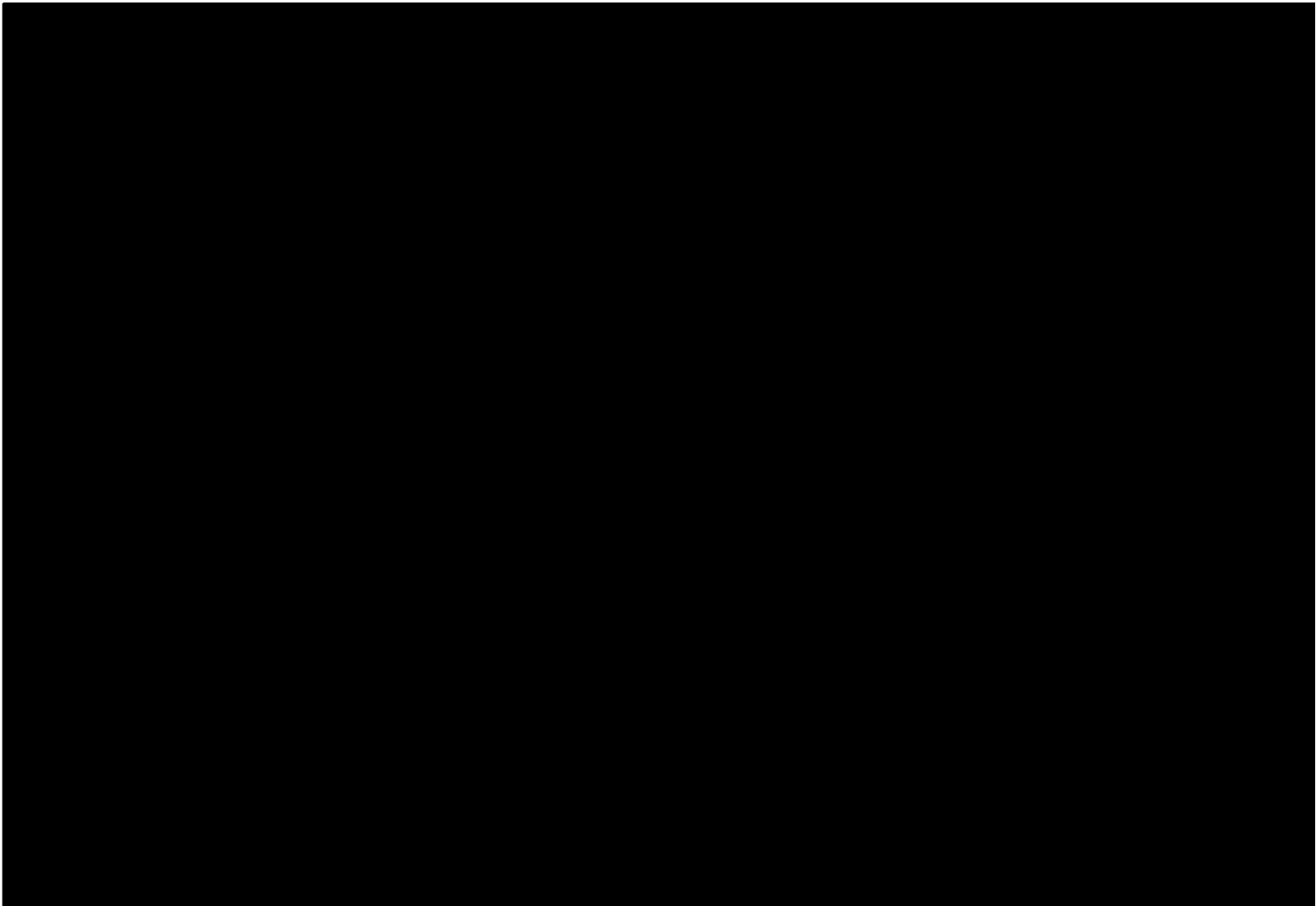

## 8. PLC (Aries-Q)



CONFIDENTIAL  
I

# 9. Schedule : Development Schedule - Aries

	2009	2010						
	Dec	Jan	Feb	Mar	Apr	May	Jun	Jul
<b>Design</b>	→	Final Design W2 (1/15)	→	Mount Review W4 (1/29)				
<b>Product Planning</b>	→		DIA Completion W5 (2/3)					
<b>Standard Approval</b>								
<b>DV</b>	DV →			DVR W12 (3/24)				
<b>PV</b>				PV →	FVR W16 (4/21)			
<b>PR</b>					→	PRA W18 (5/6)		
<b>TA</b>								
<b>Shipment</b>						Internal Target W20 (5/20)	SRA	Announced SRA W26 (7/2)
<b>Sample</b>		MWC W/S 10EA W5 (2/5)	○	Pre-MKT 500EA W7 (2/19)				

CONFIDENTIAL  
I

# 9. Schedule : Development Schedule – Aries-Q

	2009	2010							
	Dec	Jan	Feb	Mar	Apr	May	Jun	Jul	Aug
<b>Design</b>		Design Confirmation W2 (1/15)	Review as Mounted W3 (1/22)						
<b>Product Planning</b>			DIA Completion W5 (2/3)						
<b>DV</b>		DV			DVR W16 (4/23)				
<b>PV</b>					PV		PVR W20 (5/20)		
<b>PR</b>							PRA W22 (6/4)		
<b>TA</b>									
<b>Shipment</b>							Internal Goal SRA W24 (6/18)		Official SRA W31 (8/2)
<b>Sample</b>				Pre-MKT 300EA W12 (3/26)					

CONFIDENTIAL  
I

# 9. Schedule : Global Launch Plan

Aries Regional Development Schedule (Based on Internal Goal SRA 5/20)

		2010											
Classification	Dimension (Thickness: mm)	March	April	May	June	July	August	September	October	November	December		
<b>G. GSM (open)</b>	9.9T	DIA 2/3	→			SRA 5/20							
		GPG 4 Major Carriers	→			SRA 6/25							
		North America GSM TMO	DIA 2/8	→				SRA 7/14					
		Domestic	DIA 2/3	SRA 3/30									
China CMCC	10.8T	DIA 2/17	→				SRA 7/14						
Central/South America		DIA 2/3	→			SRA 5/20							
Japan		DIA 2/24	→									SRA 11/30	

Confidential Business Information -- Subject to Protective Order

S-ITC-007849470



# Schedule - Service

CONFIDENTIAL  
L

	PVR	PRA	SRA
<b>Widget</b>	<ul style="list-style-type: none"> <li>• Check contract with CPs</li> <li>• Check embedding widget list</li> <li>• Check regional coverage of each widget</li> <li>• Complete widget development</li> <li>• Complete unit test</li> </ul>	<ul style="list-style-type: none"> <li>• Complete unit test</li> <li>• Check local language translation</li> <li>• Interoperability test among device, Widget server, and each CP server</li> </ul>	
<b>SNS</b>	<ul style="list-style-type: none"> <li>• Check development status of widget and application</li> <li>• Check contract with each SNS SPs</li> <li>• Check supporting SNS list</li> </ul>	<ul style="list-style-type: none"> <li>• Interoperability test among device, Samsung server, and each SNS server</li> </ul>	
<b>Integrated Phonebook</b>	<ul style="list-style-type: none"> <li>• Check contract with each ISPs</li> <li>• Check supporting ISP list</li> <li>• Check development status of following S/W               <ul style="list-style-type: none"> <li>SEVEN Engine</li> <li>IM Client</li> <li>Email Client</li> <li>Service Integration</li> </ul> </li> </ul>	<ul style="list-style-type: none"> <li>• Interoperability test among device, Samsung server, and each ISP server</li> </ul>	
<b>kies</b>	<ul style="list-style-type: none"> <li>• Check PC Application development status</li> <li>• Complete unit test</li> </ul>	<ul style="list-style-type: none"> <li>• Check connectivity test between PC and device</li> </ul>	

# Aries(S1) (I9000)

Smartphone for Smart Life

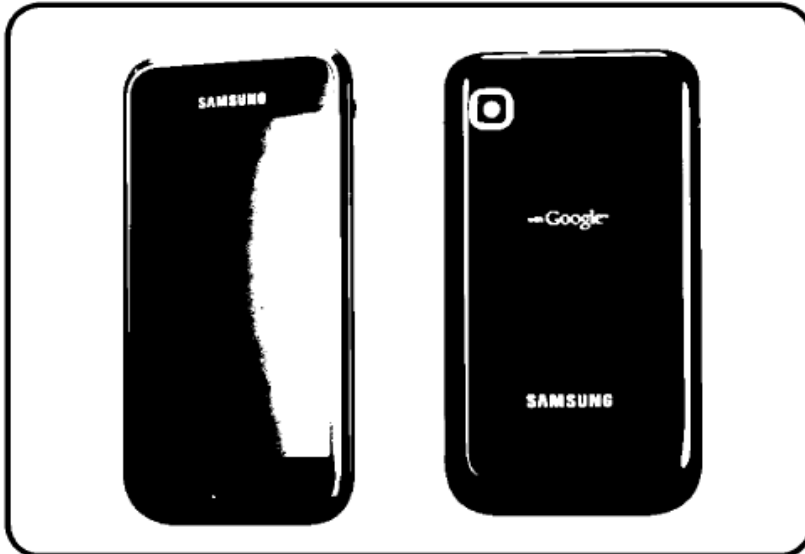

Bearer	Cam.	LCD	OS	Type
HSUPA	5M	4.0" WVGA	Android (Éclair)	Touch

**Availability** May 2010

**T/P** € 380

**Predecessor**  
GT-I7500 (5MP, Android)



Infotainment  
Rich Media

Operator's  
Category

## Key Features (USP):

1. Large(4.0") & Thin(9.9t) Stylish Design  
- Slimmest w/ 1500mAh Battery
2. Ultra Vivid Display with On-Cell AMOLED  
- Best Readability & Low Power Consumption
3. Social Hub: Unified Social Life  
- Integrated Phonebook w/ SNS, IM, E-mail  
- Life Manager : Unified Calendar
4. Widget Almighty  
- Multiple Information In a Widget  
. Hybrid Clock, Buddies Now etc

**Main Color** TBD  
**Freq. Band** 3G 900/1900/2100  
2G 850/900/1800/1900

<b>I9000</b>	<b>GPP Aries(S1)</b>
Galaxy(I7500)'s Successor	Smartphone for Smart Life

**Form Factor & Design**

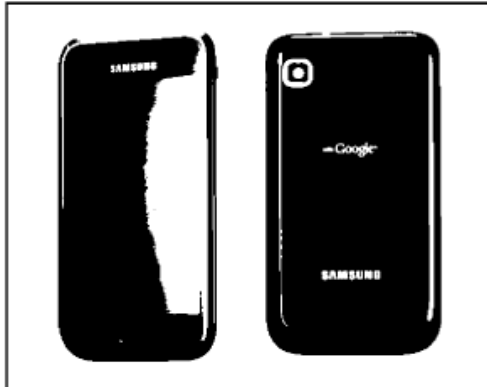

Slider	Folder	Bar	Touch	Qwerty
		○	○	

**Dimensions & Weight**

- 64.2 x 122.4 x 9.9 mm, TBD g

**USPs**

1. Large(4.0") & Thin(9.9t) Stylish Design
  - Slimmest w/ 1500mAh Battery
2. Ultra Vivid Display with OOAMOLED
  - Best Readability & Low Power Consumption
3. Social Hub: Unified Social Life
  - Integrated Phonebook w/ SNS, IM etc
  - Life Manager : Unified Calendar
4. Widget Almighty
  - Multiple Information In a Widget
  - . Hybrid Clock, Buddies Now etc

**Main Features**

Operating System	Android OS Éclair 2.1
Chipset	BB: IFX6160 / AP: S5P C110
Camera	5MP AF w/o LED flash
Display Resolution/Size	4.0" WVGA On-Cell AMOLED
3G Bearer &Band	HSUPA 5.76 Mbps 900/1900/2100
2G Bearer &Band	EDGE/GPRS 850/900/1800/1900
Connectivity	BT 2.1, USB 2.0, WiFi(b/g/n), MicroUSB
GPS	A-GPS
Radio	FM Radio with RDS
Audio	MP3, AAC, AAC+, eAAC+, WMA, RA
Video	MPEG4, H.263, H.264, WMV, RV, DivX, Xvid
Memory	4Gb+3Gb+1Gb/16GB MoviNAND, MicroSD (upto 32GB)
Additional Applications	TouchWiz 3.0 for Android, Multistage, Augmented Reality, Integrated phonebook with SNS, IM &E-mail
Talk/Standby time	1500 mAh
SPK	11x15

	<b>1 (Main)</b>	<b>2 (option)</b>	<b>3 (option)</b>
CMF	-		
<b>SRA</b>	<b>'10.05</b>		
M/C, ASP	<b>\$205, €380(16GB)</b>		
Release Area	<b>Global</b>		

**Jan. 31<sup>th</sup> 2010**

**Target Category**

- Infotainment

**Target Segment**

- Rich Media

**Main competitors**

- iPhone 3G S
- NexusOne
- Moto Droid
- SENC X10
- HTC Bravo

**Inbox VPS**

- Data Cable
- TA
- Headset

**Optional VPS**

- Basic Cradle
- Stereo Speaker
- Project Module
- Car Navi-kit
- BT Headset
- C-type Stylus Pen

# Aries-Q (S1-Q) (I9050)

Innovative Social Bridge – Easier to Cross

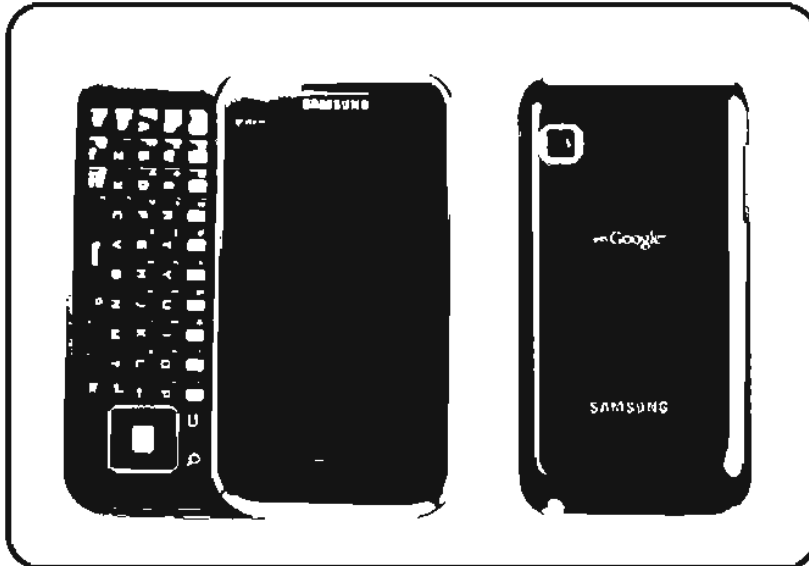

Bearer	Cam.	LCD	OS	Type
HSUPA	5M	4.0" WVGA	Android (Éclair)	Touch+ QWERTY

<b>Availability</b>	Jun. 2010	<b>T/P</b>	€ 400
---------------------	-----------	------------	-------

**Predecessor**  
GT-I9000 (5MP, Android)

Infotainment  
Rich Media

Operator's  
Category

**Key Features (USP):**

- Best Input Interface for Mobile Web
  - Optimal input interface for GMS, IM & Write & Go
- Ultra Vivid and Clear Display with AMOLED +
  - Best readability & Low power consumption
- Unified Social Life
  - Integrated Phonebook w/ SNS, IM, E-mail
  - Real-time Update : Push Services
  - Life Manager : Unified Calendar
- Widget Almighty
  - Multiple Information In a Widget
  - Hybrid Clock, Living Buddies, Days etc

<b>Main Color</b>	TBD
<b>Freq. Band</b>	3G 900/1900/2100 2G 850/900/1800/1900

<b>GT-I9050</b>	<b>GPP Aries-Q (S1-Q)</b>
Aries(I9000)'s Successor	Innovative Social Bridge – Easier to Cross

**Form Factor & Design**



Slider	Folder	Bar	Touch	Qwerty
<input type="radio"/>	<input type="radio"/>	<input type="radio"/>	<input type="radio"/>	<input type="radio"/>

**Dimensions & Weight**

- 126 x 64.2 x 13.5 mm, TBD g

- USPs**
- Best Input Interface for Mobile Web
  - Unified Social Life
    - . Integrated PB with SNS, IM, E-mail
    - . Real-time Update : Push Services
    - . Life Manager : Unified Calendar
  - Widget Almighty
    - . Unified Multiple Widgets
  - Focus & Find
    - . Augmented Reality Social Browser
  - Powerful Multimedia

**Main Features**

Operating System	Android OS Éclair 2.1
Chipset	BB: IFX6160 / AP: S5P C110
Camera	5MP AF w/o LED Flash
Display Resolution/Size	4.0" WVGA On-Cell AMOLED
3G Bearer &Band	HSUPA 5.76 Mbps 900/1900/2100
2G Bearer &Band	EDGE/GPRS 850/900/1800/1900
Connectivity	BT 2.1, USB 2.0, WiFi(b/g/n), MicroUSB
GPS	A-GPS
Radio	FM Radio with RDS
Audio	MP3, AAC, AAC+, eAAC+, WMA, RA
Video	MPEG4, H.263, H.264, WMV, RV, DivX, Xvid
Memory	4Gb+3Gb+1Gb+16GB moviNAND, MicroSD (up to 32GB)
Additional Applications	TouchWiz 3.0 for Android, Multistage, Augmented Reality, Integrated phonebook with SNS, IM, E-mail, etc.
Talk/Standby time	1500 mAh
SPK	11x15

	<b>1 (Main)</b>	<b>2 (option)</b>	<b>3 (option)</b>
CMF	-		
<b>SRA</b>	<b>'10.06</b>		
M/C, ASP	<b>\$217, €400 (16GB)</b>		
Release Area	<b>Global</b>		

**Feb. 3<sup>rd</sup> 2010**

**Target Category**

- Infotainment

**Target Segment**

- Rich Media

**Main competitors**

- Moto Droid  
- HTC Bravo  
- Google Nexus One

**Inbox VPS**

- Data Cable  
- TA  
- Headset

**Optional VPS**

- Basic Cradle  
- Stereo Speaker  
- Project Module  
- Car Navi-kit  
- BT Headset

# Appendix

# Competitiveness Review

CONFIDENTIAL  
I

## Strengths compared to iPhone

- Multi-tasking supported  
(Up to 6 viewable on Aries, possible as permitted by memory)
- Diverse video file formats supported  
(iPhone only supports mp4)
- Carrier customization allowed
- **Universal search (Local+Web search)**
- FOTA upgrade allowed

(has to connect to iTunes via cable and download at home for iPhone)

- Adobe Flash 9 Supported

## Strengths compared to other Androids

- Samsung Android UX applied
- Superior HW spec  
(Super AMOLED, 1GHz Chipset, VT Call support, etc.)
- Additional marketplace other than Android Market provided, such as More Widget, Slideme, etc.
- Plenty of User Memory Provided for storing applications and contents (16GB default)
- Multi-touch Pinch zoom in/out applied
- Convergence between devices: 3 Screen (DLNA)



## [Shared Strengths]

- Fast typing with Swype Integration
- Social Hub (Integrated Phonebook) Supported
- **Hybrid Widgets**
- Context Awareness UX applied

# Android Platform Roadmap

<p><b>Android 1.0</b> (Sep '08)</p>	<ul style="list-style-type: none"> <li>✓ Linux kernel 2.6.25</li> <li>✓ MSM 7K chipsets</li> <li>✓ RIL, Wi-Fi, BT 2.0 support</li> <li>✓ HVGA support</li> </ul>
<p><b>Cupcake</b> (Apr '09)</p>	<ul style="list-style-type: none"> <li>✓ Linux kernel 2.6.27</li> <li>✓ UI refinement</li> <li>✓ Performance improvements</li> <li>- Faster camera start-up &amp; image capture</li> <li>- Faster acquisition of GPS location</li> <li>- Smoother pad scrolling in browser</li> <li>✓ <u>New features</u></li> </ul>
<p><b>Donut</b> (Sep '09)</p>	<ul style="list-style-type: none"> <li>✓ Linux kernel 2.6.29</li> <li>✓ Open core 2</li> <li>✓ Support for CDMA</li> <li>✓ Various LCD resolution (QVGA, HVGA, WVGA, WQVGA)</li> <li>✓ Text-to-speech engine(Pico) and APIs</li> <li>✓ VPN support</li> <li>✓ Quick Search Box (Universal Search)</li> <li>✓ <u>New features</u></li> </ul>
<p><b>Éclair</b> (Nov '09)</p>	<ul style="list-style-type: none"> <li>✓ Linux kernel 2.6.30</li> <li>✓ Support 3D engine</li> <li>✓ OpenGL ES 2.0</li> <li>✓ Improved audio routing</li> <li>✓ Browser support for HTML5</li> <li>✓ Exchange support</li> <li>✓ Refreshed UI</li> <li>✓ Social Contacts support</li> <li>✓ <u>New features</u></li> </ul>
<p><b>Froyo</b> (May/Jun '10)</p>	<ul style="list-style-type: none"> <li>✓ JIT (Just in Time) Compiler</li> <li>✓ App installation on SD Card</li> <li>✓ Flash support via Adobe Flash plugin</li> <li>✓ New UI for Music &amp; Gallery Application</li> <li>✓ Unbundling of apps with platform</li> <li>✓ Exchange Calendar Sync</li> <li>✓ Tethering / DUN on Bluetooth</li> <li>✓ <u>New features</u></li> </ul>



# Android 1.5 – New Feature

## Android 1.5 (Cupcake)

### User interface refinements:

#### System-wide:

- Refinement of all core UI elements
- Animated window transitions (off by default)
- Accelerometer-based application rotations

### Performance improvements:

- Faster Camera start-up and image capture
- Much faster acquisition of GPS location (powered by SUPL AGPS)
- Smoother page scrolling in Browser

### Applications

- Camera & Gallery ; Video recording / Video playback (MPEG-4 & 3GP formats)
- Browser ; Updated with latest Webkit browser & Squirrelfish Javascript engines, Copy 'n paste in browser,, etc.
- Contacts ; Shows user picture for Favorites, Specific date/time stamp for events in call log, etc.

### Application framework

- On-screen soft keyboard ; Works in both portrait and landscape orientation, User dictionary for custom words, etc.
- Home screen ; Widgets, Live folders
- UI framework ; Framework for easier background/UI thread interaction, New SlidingDrawer widget, etc.
- Home Screen framework ; APIs for creating secure home screen widgets, etc.
- Media framework ; Raw audio recording and playback APIs, Interactive MIDI playback engine, Media search Intent, etc.
- Input Method framework ; Text prediction engine, Ability to provide downloadable IMEs to users
- Speech recognition framework ; Support for using speech recognition libraries via Intent
- Misc API additions

 for more, visit [HERE](#)

# Android 1.6 – New Feature

## Android 1.6 (Donut)

### User interface refinements:

- Quick Search Box: search across multiple sources from home screen (browser bookmarks, history, contacts, and the web)
- Battery usage indicator: lets users see which apps and services are consuming battery power
- Camera: Integrated camera, camcorder, and gallery experience, enable user to select multiple photos

### Performance improvements:

- Faster Camera experience: launching the camera, completing one shot to the next

### Android Market Updates

- At the homescreen, users can choose among Apps, Games, and Downloads.
- Inside a category, users can explore titles that are Top paid, Top free, and Just in.
- For each title, users can now see screenshots submitted by developers in addition to reviews from other users

### Application framework

- VPN, 802.1x: VPN control panel in Settings
- Text-to-speech engine(Pico): allows any Android application to "speak" a string of text with an accent (supports the following languages: English (American and British accents), French, Italian, German and Spanish)
- Gestures: creating, storing, loading, and recognizing gestures and associating them with specific actions (GestureBuilder tool included in the Android 1.6 SDK)
- Accessibility: accessibility plugins that respond to user input, such as making a sound when a new window is shown, vibrating when navigating to the top of a list, and providing spoken feedback

 for more, visit [HERE](#)

# Android 2.0 – New Feature

## Android 2.0 (Éclair)

### User interface refinements

- **Contacts & accounts:** Sync support for contact sync from multiple data sources including Exchange.  
Handset manufacturers will need EAS license for distribution.
- **Mail:** Exchange support. Handset manufacturers will need EAS license for distribution.  
Merged folders across multiple accounts for inbox, unread, flagged
- **Camera :** Support for built-in flash
- **Android keyboard :** Improved layout and better responsiveness, Smarter dictionary
- **Browser:** Refreshed UI with actionable browser URL bar, Support for double-tap to zoom
- **Calendar:** Agenda view with infinite scrolling, Attendee status and guest invites
- **Messaging:** Ability to search SMS and MMS messages, Auto-delete old messages when short on storage

### New Platform Technologies

- **Media framework:** Completely revamped graphics architecture for improved performance enabling better hardware acceleration
- **Bluetooth:** New BT profiles(Object Push Profile (OPP), Phone Book Access Profile (PBAP), Bluetooth 2.1

### New Developer APIs

- **Bluetooth:** Turn on/off Bluetooth, device and service discovery, send/receive data
- **Sync adapters:** New APIs for contacts sync adapters to connect to any backend
- **Account Manager API:** Centralized account manager API to securely store and access auth tokens/passwords across one or more services
- **Contacts APIs:** New contacts APIs that allow for data from multiple accounts, Support for 3rd party sync adapters
- **WebView:** HTML5 support(Database API, Application cache, Geolocation API, <video> tag support in Fullscreen mode)
- **Framework:** Framework support for simultaneous touch events

# Android Froyo Features

---

## Android Froyo (Former Flan)

- OS version upgrade with the goal of improving performance as well as increasing user convenience
- More features than the Éclair but same or less RAM/ROM requirement through OS optimization (fit & polish)
- Scheduled for announcement 2010 May or June, Official Letter is scheduled for delivery to partner companies by the second week of February

### Performance Improvement

- JIT(Just in Time Compiler) loaded – Increase performance of JAVA application (Also loaded on the Éclair but function revitalized for the first time with Froyo)
- Loaded Stagefright instead of the formerly used Opencore to make the OS more lighter and faster
- Kernel: 2.6.32 (Éclair: 2.6.30)



### Increasing User Convenience

- Applications can be saved on the SD card (formerly: Only savable on the internal memory)
- Adobe Flash supported: Adobe Flash Browser Plugin downloadable through Android Market
- Unbundling of apps with platform
  - Update possible for Google Mobile Services as well as system app through Android Market
- New UI as well as partial UI refresh for Music & Gallery App

### Etc.

- Exchange Support – Calendar Sync, Password Admin (Remote Wipe function loaded)
- Tethering function using USB as well as BT(DUN)
- Publication of referential sample code scheduled to support game developers

# Apple App Store vs. Google Android Market

Apple App Store		Google Android Market
	<p>Image</p>	
77 Countries	Coverage	26 Countries
Developer 70%, Apple 30%	R/S Model	Developer 70%, Operator 30%
133,979	Number of Applications	23,475
Game, Apps (20 Categories)	Categories	Games, Apps (18 Categories)
On-Device Client (Wireless) iTunes(Non-Wireless)	Store Channel	On-Device Client (Wireless)
Credit Card, iTunes Gift Card	Payment	Credit Card, Operator Billing
<p>Superiority of Apps with a variety of local apps through entering many countries</p> <ul style="list-style-type: none"> <li>Membership fee \$99 (individual), \$299 (corporations)</li> </ul>	Etc.	<ul style="list-style-type: none"> <li>Comparatively inferior expansion speed as it is not a source of profit but only uses GSM's partial appl</li> <li>Membership fee \$25 (same)</li> <li>Business friendly by sharing 30% profit</li> </ul>
<ul style="list-style-type: none"> <li>Continuous expansion and growth in number of apps along with the iPhone, iPad (300,000 anticipated by the end of 2010)</li> </ul>	Assessment	<ul style="list-style-type: none"> <li>The number of Apps is comparatively lesser due to a slower terminal expansion speed of the iPhone however a an Android Market Promotion is scheduled for the middle of 2010</li> </ul>

# Intuitive Touch UX (1)

## ● Easier & More Customizable UX, TouchWiz 3.0

### 1. Integrated Home Screen

- 4 Menu Customizing possible within the Widget screen
  - Combined Home screen
- Title set-up possible by Widget/Menu page
  - Easy of Managing



### 2. Maximizing Contents Area

- Maximize contents within the screen with simple Menu/Key arrangements on screens such as Video, Browser



### 3. Efficient Multitasking, Quick Panel

- Maximization of the Multi-Tasking environment with Quick Panel, Task Switcher and others



Quick Panel



Task Switcher

### 4. Gesture Interaction

- Eliminated unnecessary interaction and strengthened usability by inserting Quick Panel & More Option window through Sweeping Up/Down Gesture



# Intuitive Touch UX (2)

## ● Hybrid Widget

- Improved information gathering by comprising various features in one Widget.
  - ✓ Info alarm – weather, stock, latest news information real time Update
  - ✓ Hybrid clock - clock with various contents (finance, weather etc.)
- Consolidated management of SNS and Contact Update status possible in one Widget (Live Buddy, etc.)

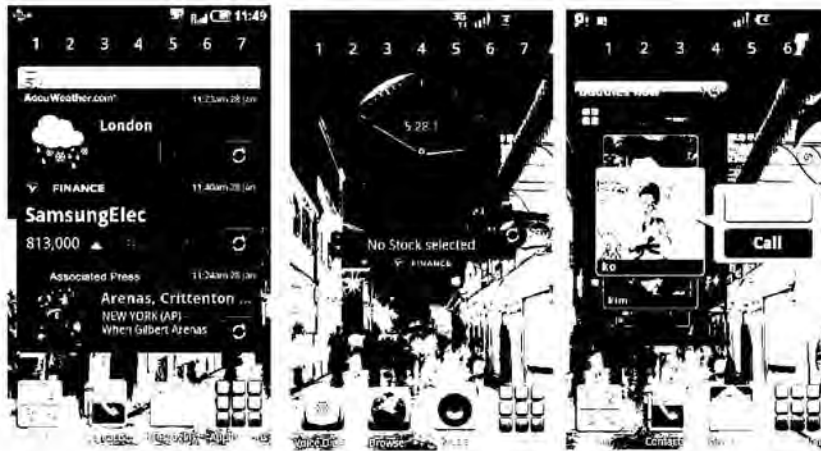

Advanced widgets

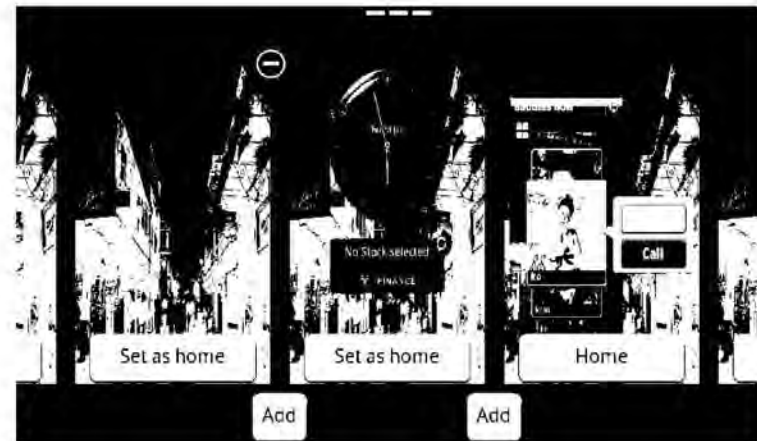

Menu/widget page edit

# Intuitive Touch UX (3)

## ● More Comfortable Input Mechanism

### - SWYPE

- ✓ Fast word input possible with a finger or stylus gliding on the keyboard
- ✓ SWYPE vs. iPhone performance comparison (Inputting 25 words)  
: SWYPE 39sec vs. iPhone 79sec → 1.5x faster



Ex) Inputting the word "cool"

### - XT9



- ✓ Provides words frequently used by the user in advance by prediction (able to set on/off)
- ✓ Able to add & edit desired words by the user

### - Voice Command

- ✓ Improved user convenience by providing various voice recognition features (Voice Dialing/Playing/Recording)
- ✓ Provides notifications to the user through Text-to-Speech control (Time & Date, Battery Level, Signal Strength, Memory Status, etc.)

→ Provides Beyond Touch Experience



# Unified Social Life (1)



- Real-time Push Service

Establishes 'Always-on Communication Channel' through real time updates based on PIMS(Phonebook/Calendar), SNS, Messaging(IM, Email) Push

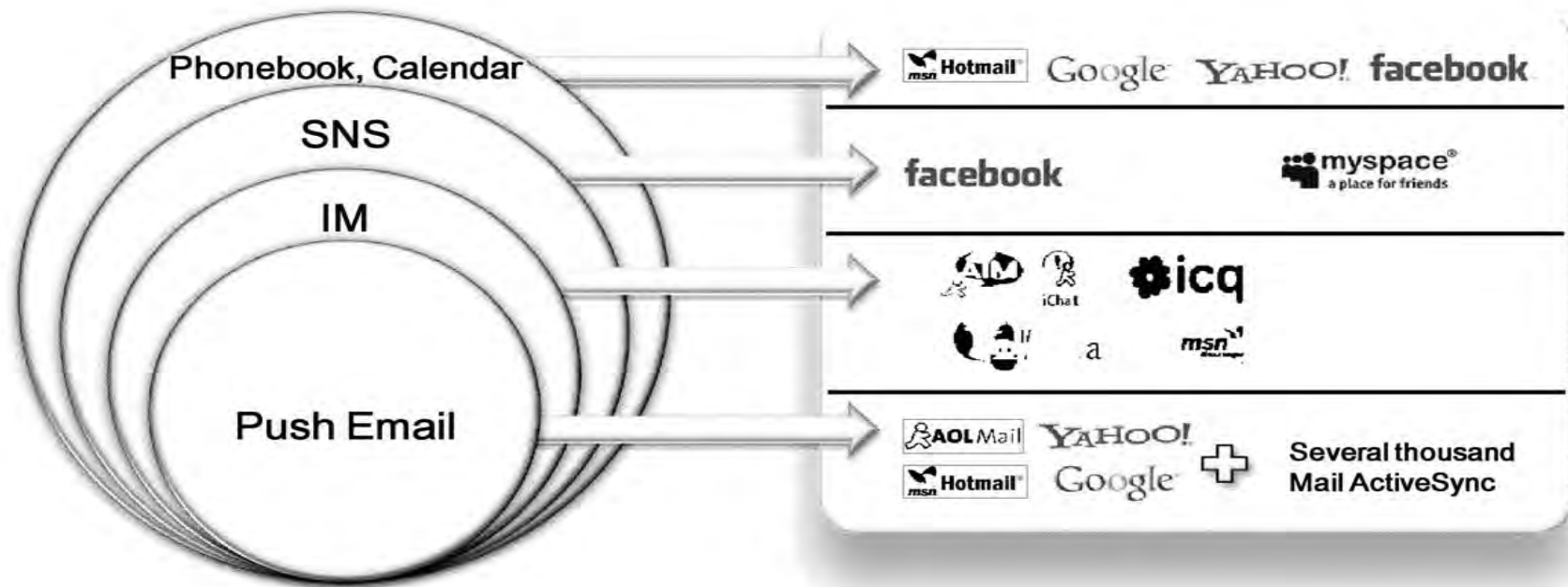

# Unified Social Life (2)

## ● Unified Phonebook

- Consolidated management possible on phone through integrating 4 portals and major SNS
- IM Login confirmation and chatting possible in Contact info



➔  
Contact List Consolidation



## ● Unified Calendar

- Consolidated management possible on phone through integrating Outlook and Facebook
- Displays the integrated schedule information sorted by the source



➔  
Schedule Information Consolidation



## ● Easy Email Set-up

- Easy set-up of Email using the Email address and Password possible by providing information for more than 10 thousand Email ISPs

# More Intelligent Web Experience

## ● Customizing Google Chrome browser

- Value-added Features added on Chrome Browser provided by Android Éclair version

- ✓ Flash Lite 3.1 support : Displays Flash videos on major portals
- ✓ Improved Download feature : OMA Download support → DRM Contents Download possible

→ Provides PC-like Web Experience compared to other Android Phones

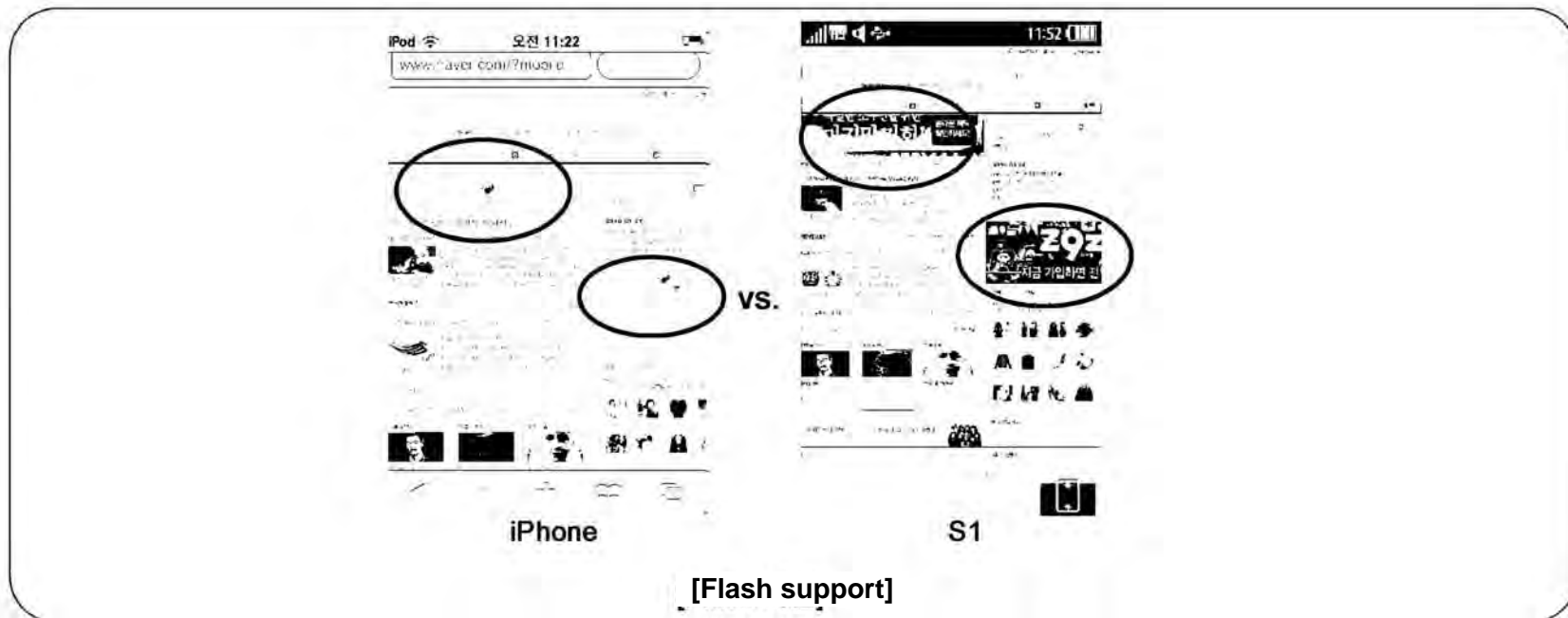

# Special Embedded Features

## ● Layar

### - Social browser based on Augmented-Reality

- ✓ Displays the location of desired contents as an icon through Camera View (Wikipedia, restaurant location and phone number, others' SNS, etc.)



## ● EverNote

### - Record & Access possible anytime, anywhere through Text, Photo, and Audio

- ✓ Text, photo & audio notes creation possible
- ✓ Text search possible within image
- ✓ Share and Sync of all created Note among Phone, PC, and Server



## ● FlipFont **fl!pfont**

### -Phone Title/Menu font can be modified to a font downloaded by the user

- Customizing possible according to the user preference

# Enhanced Connectivity (1)

## ● Faster, Broader, and More Efficient Wi-Fi Experience

- Improved Wireless Access performance by supporting 802.11 b/g + 802.11 n



### -WiFi usability improvement

(Image modification planned)

- ✓ **Quick Panel : WiFi on/off setting possible in Idle screen**
- ✓ **Auto Connecting : WiFi automatic access possible when the frequented AP is found after the AP search**

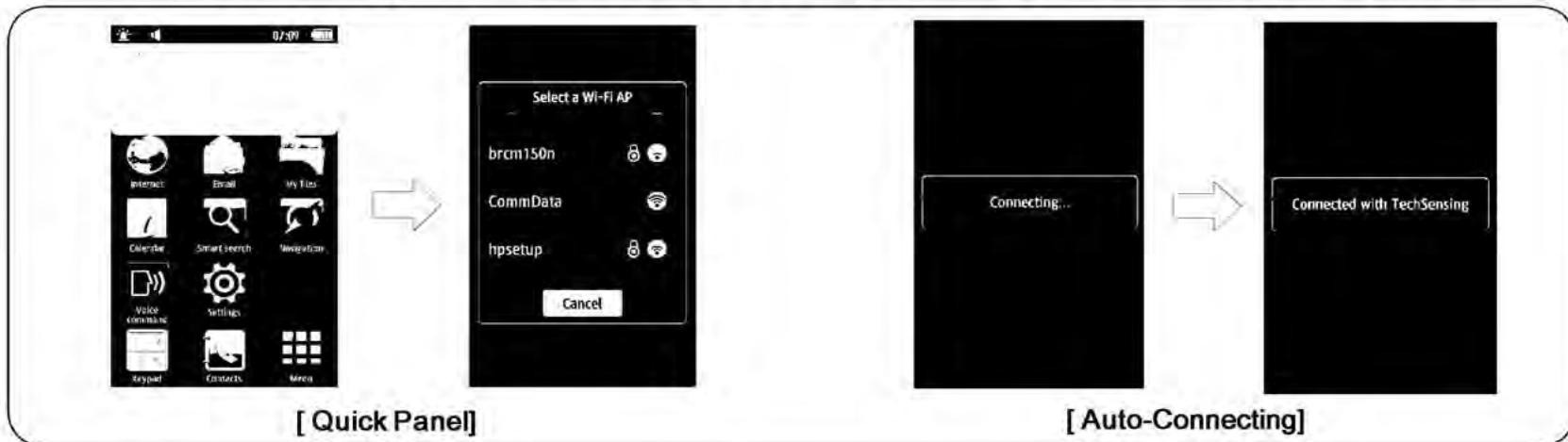

## Enhanced Connectivity (2)

- Upgrade Short-Distance Communication,



- Expands utilization of short-distance communication through mobile phone by supporting various Bluetooth 3.0 Profile

- ✓ Added features such as BPP (Remote Printing), FTP (File sending) unsupported by iPhone

- Mobile AP

- Supports Tethering Application which utilizes mobile phone as Wireless Access Point

→ 3G N/W communication from WiFi enabled Mobile Device possible through mobile phone

→ Internet access anytime & anywhere

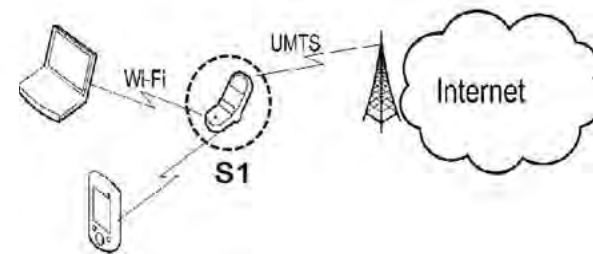

**- E N D -**

# Aries (GT-19000)

## Global GSM Level. 2

부서	담당 임원	실무
상품기획	PP	강병진 차장, 강익선 대리
	PM	권혁민 차장, 양현덕 과장
	VPS	김태길 차장, 김달원 대리
Enabling	이용배 상무	박종훈 과장, 이언지 사원
	PM	노태문 상무
개발	PL	김학상 상무
	H/W	박상률 책임
	S/W	안원익 수석
	기구	이병준 책임, 이희진 선임
	음향 Lab.	조봉조 선임, 김속경 사원
	안테나	김동환 책임, 임재호 사원
	SE 그룹	신동의 책임, 이종숙 책임, 조성래 사원
디자인	제품	이민혁 수석, 이기영 사원
	UX	AUI 윤종삼 책임, UI 김영미 선임, GUI 윤소영 책임
개발관리	고동진 전무	김진규 차장, 김영중 과장
영업	조홍식 전무, 이영우 전무, 서기용 상무, 유근의 상무, 박명동 상무, 김철진 상무	
구매	임종권 상무	이민순 차장, 김경필 대리
MSC	이경한 상무	조성원 부장, 김형수 과장
CS팀(신뢰성)	윤두표 상무	이정태 차장, 김용 과장
제품기술 H/W S/W	류택원 상무	박현규 차장
	백정호 상무	김동구 과장, 허윤도 과장



# Aries-Q (GT-19050)













## Global GSM Level. 2

부서	담당 임원	실무
상품기획	PP	강병진 차장, 안지원 사원
	PM	권혁민 차장, 양현덕 과장
	VPS	김태길 차장, 김달원 대리
Enabling	이용배 상무	박종훈 과장, 이언지 사원
	PM	김학상 상무
개발	PL	안병도 수석
	H/W	김연범 책임
	S/W	이준혁 책임
	기구	이준철 선임
	음향 Lab.	조병조 선임, 김속경 사원
	안테나	김동환 책임, 임재호 사원
	SE 그룹	신동의 책임, 이종숙 책임, 조성래 사원
디자인	제품	이민혁 수석, 이진후 사원
	UX	AUI 윤중삼 책임, UI 김효영 선임, GUI 김준석 선임
개발관리	고동진 전무	김진규 차장, 김성미 대리
영업	조홍식 전무, 이영우 전무, 서기용 상무, 유근의 상무, 박명동 상무, 김철진 상무	
구매	임종권 상무	이인순 차장, 김경필 대리
MSC	이경한 상무	조성원 부장, 김형수 과장
CS팀(신뢰성)	윤두표 상무	이정태 차장, 김용 과장
제품기술 H/W S/W	류택원 상무	박현규 차장
	백정호 상무	김동구 과장, 허윤도 과장

# 0. Content

- 1. Positioning**
  - . Roadmap
  - . Competition map
- 2. Sales Point**
- 3. Competitor Comparison**
- 4. Evaluation**
- 5. Specification**
  - . HW
  - . SW
  - . UX
  - . Service
  - . CMF
  - . 과제 점검 List
- 6. VPS**
- 7. Target Sales Volume, Price and Profit**
- 8. PLC**
- 9. Schedule**
- 10. Summary**

# 1-1. Positioning – Roadmap

Competitor	2009 2H	2010 1H
<p><b>Sony Ericsson</b> Xperia X10  '10.03 8MP 4" qHD Rachael UI 3.5pi earjack</p>		<p><b>Halo</b>  '10.05 8MP/HSUPA5.76 3.7 WVGA OCT AMOLED Mobile Projector GII Eclair</p>
<p><b>Moto</b> Milestone  '09.11 5MP 3.7 WVGA Eclair</p>	<p><b>17500 (Galaxy)</b>  '09.07 5MP/HSUPA 3.2" HVGA AMOLED 8GB + microSD Cupcake</p>	<p><b>Aries-Q</b>  '10.06 5MP/HSUPA5.76 4.0 WVGA OCT AMOLED Touch+QWERTY Eclair</p>
<p><b>HTC Hero</b>  '09.06 5MP 3.2 HVGA Sense UI</p>		<p><b>Aries</b>  '10.05 5MP/HSUPA5.76 4.0 WVGA OCT AMOLED 9.9mm Eclair</p>
<p><b>LG GW620</b>  '09.11 5MP 3.0 HVGA S Class UI</p>	<p><b>15700 (Spica)</b>  '09.10 3MP/HSDPA3.6 3.2" HVGA Affordable Android Cupcake → Eclair</p>	<p><b>China Only</b> <b>Saturn</b>  '10.02 3MP/HSUPA 5.76 3.2" HVGA AMOLED Eclair</p>
<p><b>HTC Tattoo</b>  '09.10 3MP 2.8 QVGA Sense UI Multi-Touch</p>		<p><b>Apollo</b>  '10.05 3MP/HSDPA3.6 3.2" WQVGA 1GB MicroSD Eclair</p> <p><b>Europa</b>  '10.06 2MP/HSDPA7.2 2.8" QVGA 1GB MicroSD Eclair</p>

# 1-2. Positioning – Competition map

## OS X / WM

## Samsung Android

## Android

iPhone 3G S



'09.06  
HSDPA  
3M, 3.5" HVGA  
Cortex A8/iPhoneOS

HD2



'09.11  
HSDPA  
5M, 4.3" WVGA  
QSD8250/MM 6.5

Aries-Q

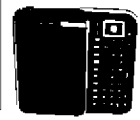

'10.06  
HSUPA  
5M, 4.0" WVGA  
6160+C110/Éclair(2.1)

Aries



'10.05  
HSUPA  
5M, 4.0" WVGA  
6160+C110/Éclair(2.1)

XPERIA X10



'10.03  
HSDPA  
8M, 4.0" FWVGA  
QSD8250/Donut

Nexus One



'10.01  
HSDPA  
5M, 3.7" WVGA  
QSD8250/Éclair(2.1)

MOTOROI



'10.02  
HSDPA  
8M, 3.7" FWVGA  
OMAP3430/Éclair(2.0)

Droid (Milestone)



'09.11  
HSDPA  
5M, 3.7" WVGA  
OMAP3430/Éclair(2.0)

Bravo



'10.04  
HSDPA  
5M, 3.7" WVGA  
QSD8250/Éclair(2.1)

## 2. Sales Point

# "The S : Samsung Superior Smartphone"

### 1

#### ***Stylish, Slim & Minimal Design***

- 4.0" Large Super AMOLED
- 9.9t Ultra-Slim w/ 1500 mAh Batt.
- Seamless Tempered Glass

### 2

#### ***Powerful Performance***

- Higher CPU Performance (1GHz)
- HD Video (720p) Play/Recording
- Fast Speed: WiFi n, BT3.0, HSUPA 5.76



### 3

#### ***Fully ranged Accessories***

- Speaker Cradle, External Battery
- Projector, Navi-kit

### 4

#### ***New User eXperience***

- Social Hub : Integrated Phonebook
- TouchWiz 3.0 w/ Hybrid Widgets (Hybrid Clock/Stock, Daily Briefing etc)
- Smart Life Enabler: Context-Aware

### 5

#### ***Advanced Features***

- Augmented Reality w/ Global POI
- Convergence by AllShare
- Enhanced Multimedia & Security

### 6

#### ***Rich Contents***

- E-book optimized for Large OCTA
- Expandable by Samsung Kies

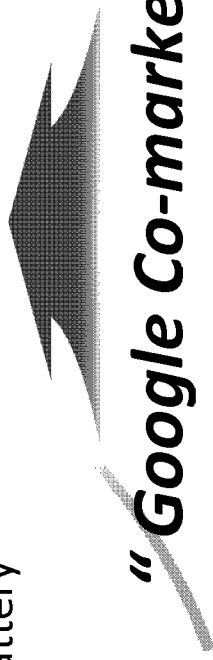

## "Google Co-marketing"

with Google™

## 2. Sales Point - Design

- Wide & Large Touch Display
- Ultra-Slim (9.9t) : 64.2 x 122.4 x 9.9 mm
- Minimal Design
- Comfortable Hand Grip

### Design Concept



9.9t

Competitors

Apple  
iPhone 3GS  
12.3 mm

HTC  
NexusOne  
11.5 mm

**Upward round for comfortable hand grip**

- 4.0 " WVGA On-Cell TSP AMOLED Display
- 9.9t Ultra-Slim Thickness (w/ 1500mAh battery)
- Refined Minimal Design
- Ergonomic Edge for Comfortable One-hand grip

# 2. Sales Point - Display

## “Super AMOLED : Crystal-clear & Ultra-thin Large Display”

✓ OCTA (On-Cell TSP AMOLED) : No Air Gap between Window Glass & LCD







Vivid Color



High Contrast

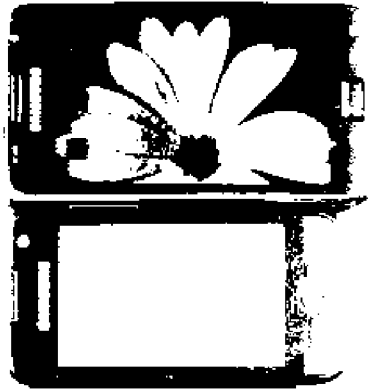

Outstanding Luminescence

- Borderless Display  
- Better Sunlight Visibility

## Super AMOLED

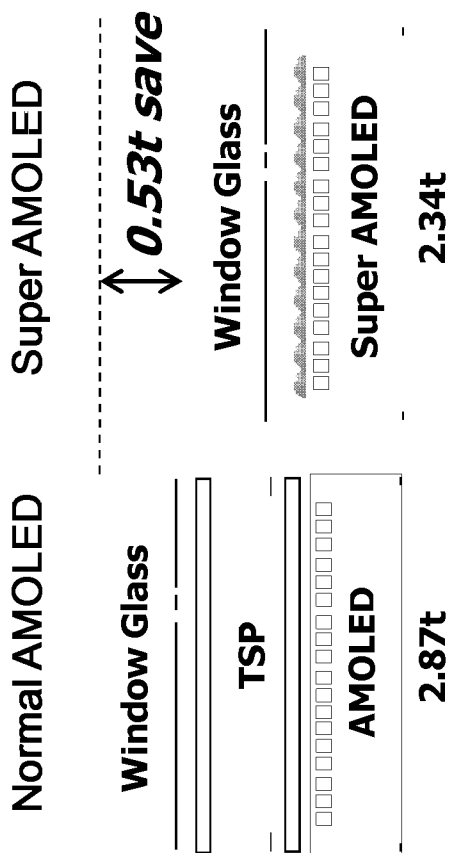

	AMOLED	Super AMOLED	improvement
Thickness	2.87t	2.34t	0.53t down (no air gap)
Luminance	240cd/m <sup>2</sup>	300cd/m <sup>2</sup>	1.25 times up
Reflectance	16%	4%	1.3 times Visibility up

[ Structure Comparison ]

[ Spec Comparison ]

## 2. Sales Point – HW Performance

### “Powerful Performance & Fast Speed”

- ✓ C111 : ARM CortexA8 1GHz, 89.5 M tri/s 3D Graphics
- ✓ WiFi b/g/n, HSUPA 5.76

. WiFi-n : up to 75 Mbps, x2 wider range than WiFi-g

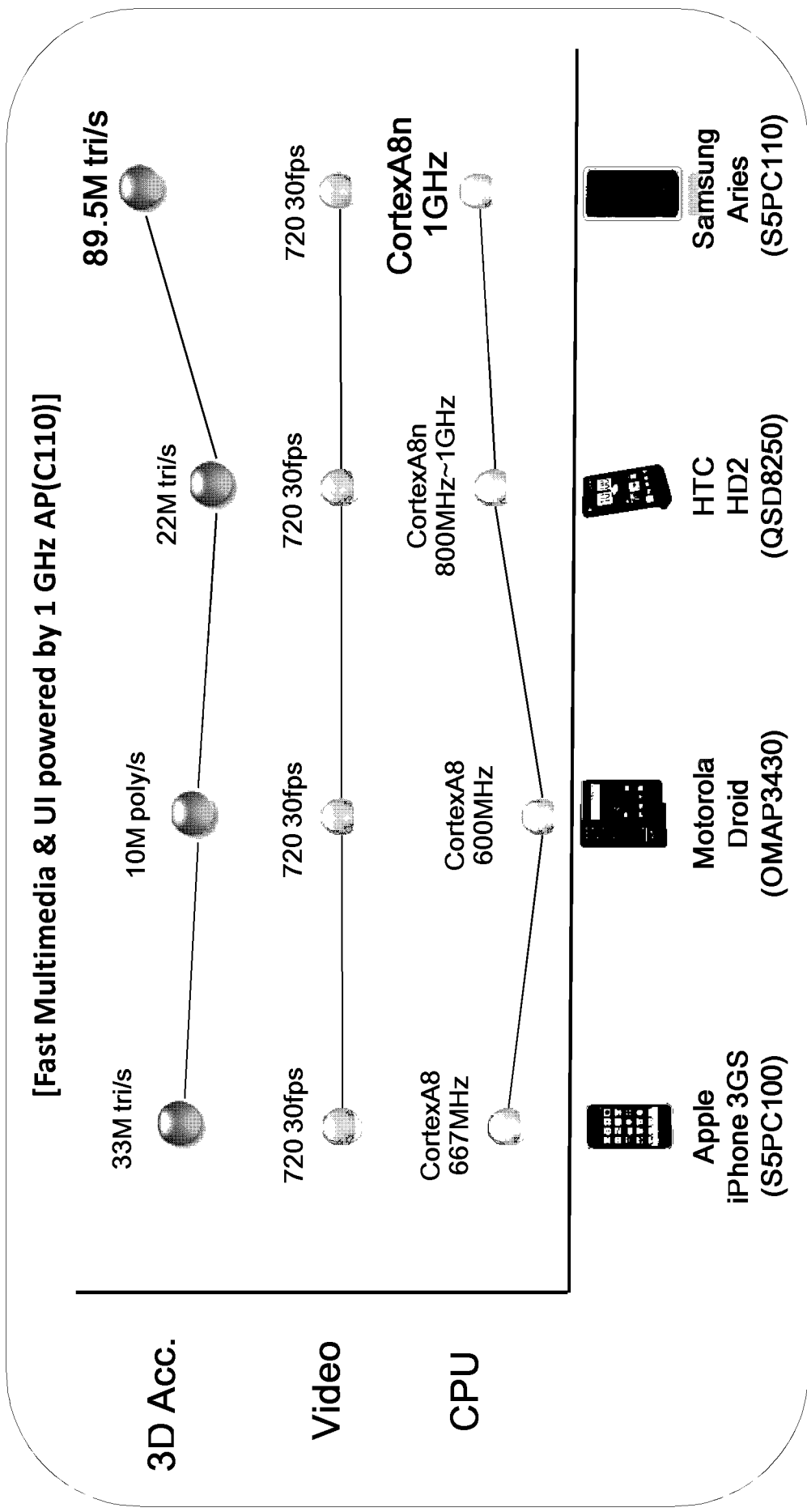
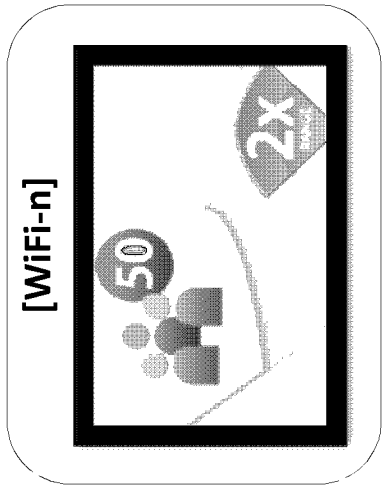



# 2. Sales Point - Multimedia

## “Maximized Multimedia Experience”

### ✓ Outstanding Multimedia & Entertainment

- HD (720p) Play & Recording, Video & Image Editor and Additional Music Info(Kies)
- Capacitive-type Multi-Touch Support
- First VT Camera for Android

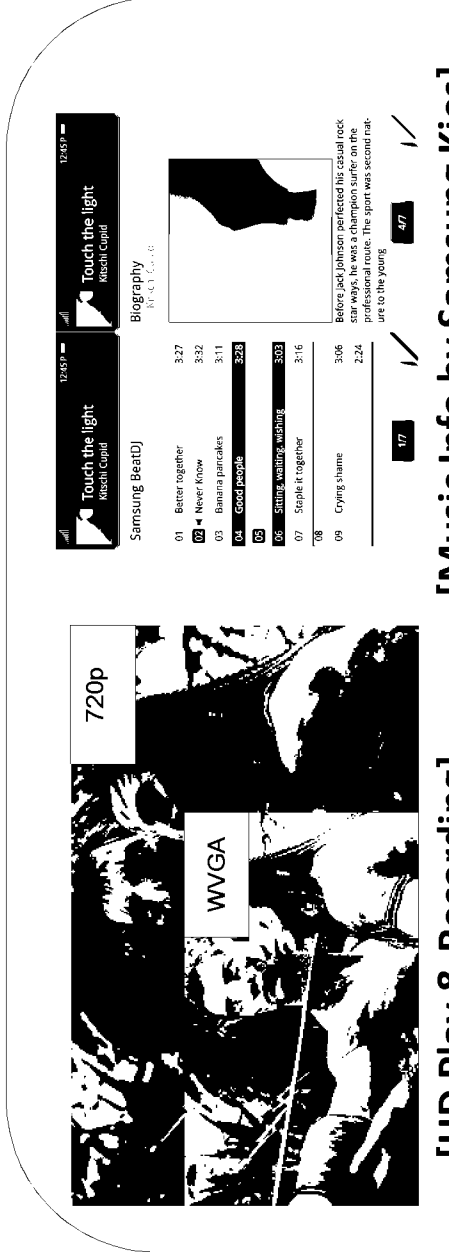
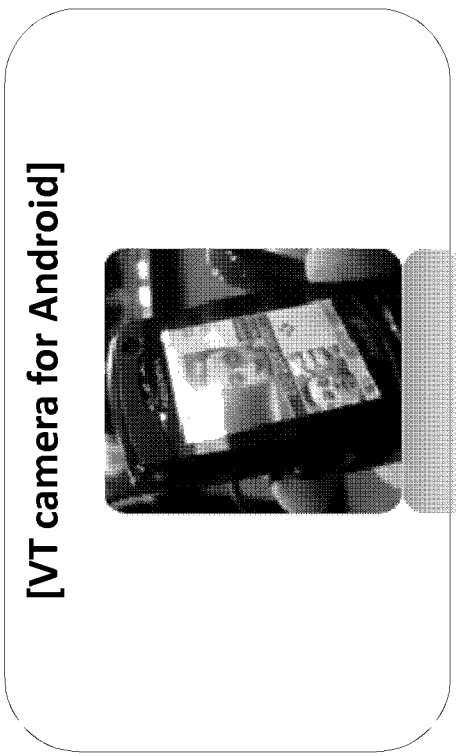
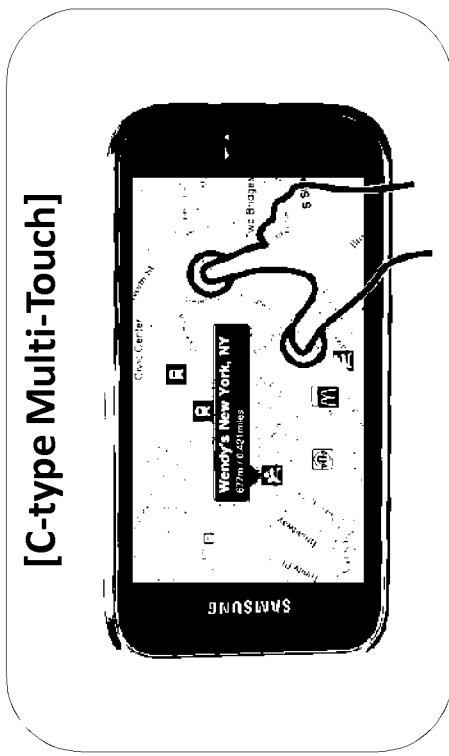

## 2. Sales Point – Social Hub

### “Share Life Experiences While on the Go”

- ✓ **Integrated Phonebook with SNS, IM, E-mail, SMS & MMS**
  - Immediate accessibility and interaction with SNS, IM, E-mail, SMS & MMS
- ✓ **Life Manager : Unified Calendar**

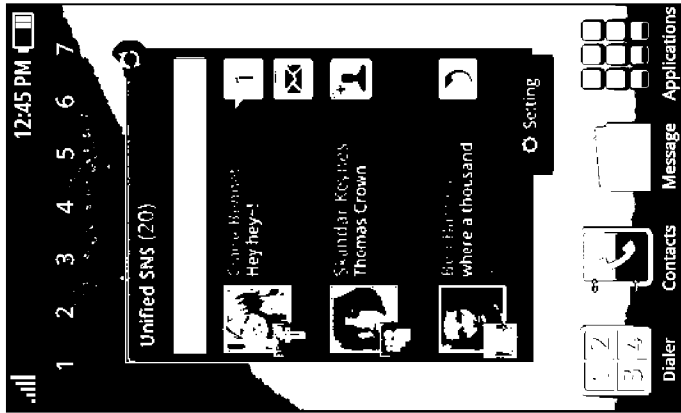

[Contact with Updated Status]

- Unified view of SNS, IM, E-mail, SMS, MMS

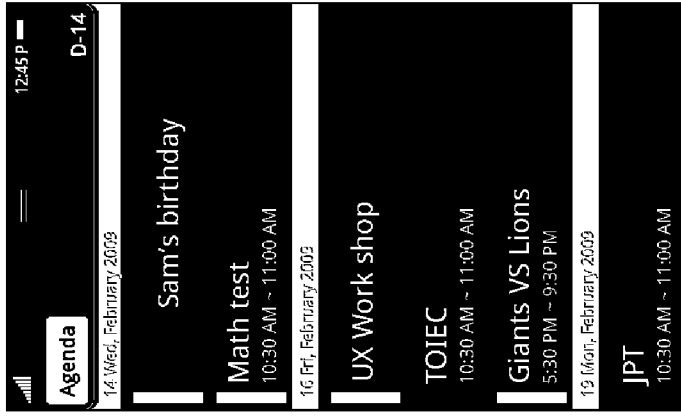
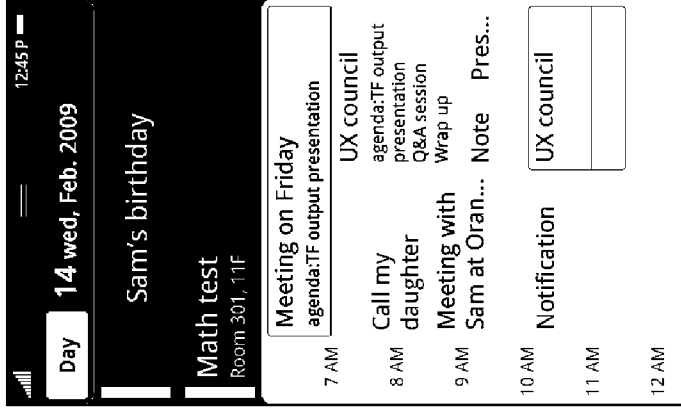
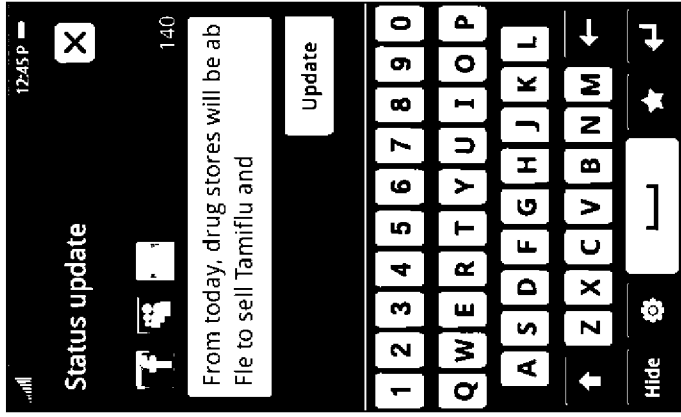

[Multiple Calendar Integration]

- Integration of Google, Outlook & Facebook Calendar

## 2. Sales Point - Widgets

### “Hybrid Widgets to Create New Experiences”

- ✓ Up-to-date Information from Multiple Widgets
- ✓ Maximize Homescreen Experience through Various Information

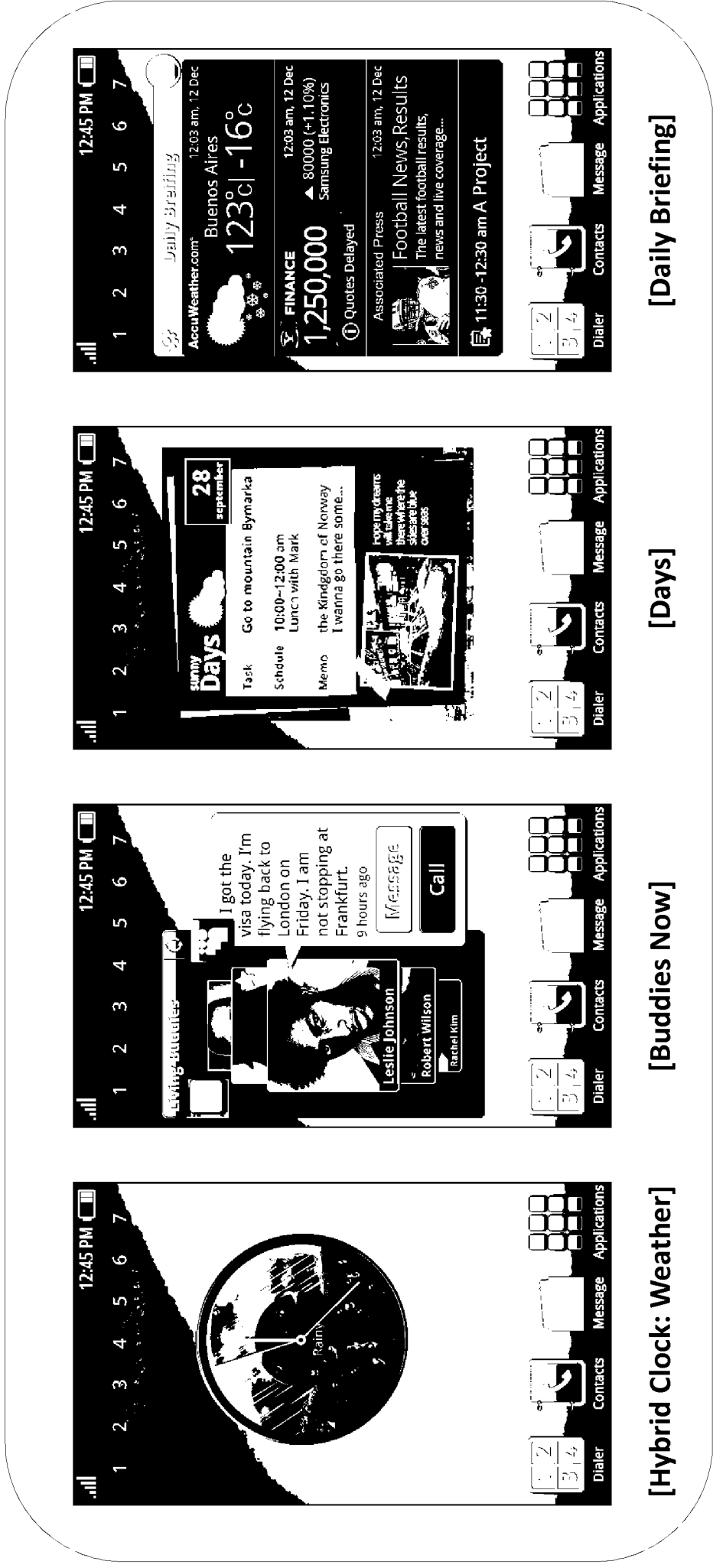

[Hybrid Clock: Weather]

[Buddies Now]

[Days]

[Daily Briefing]

# 2. Sales Point – Context-Aware

## “Smart Life Enabler by Context-Awareness”

- ✓ Customized & Evolved by Aggregating Behavior Patterns
- ✓ Always Your Smart & Friendly Companion

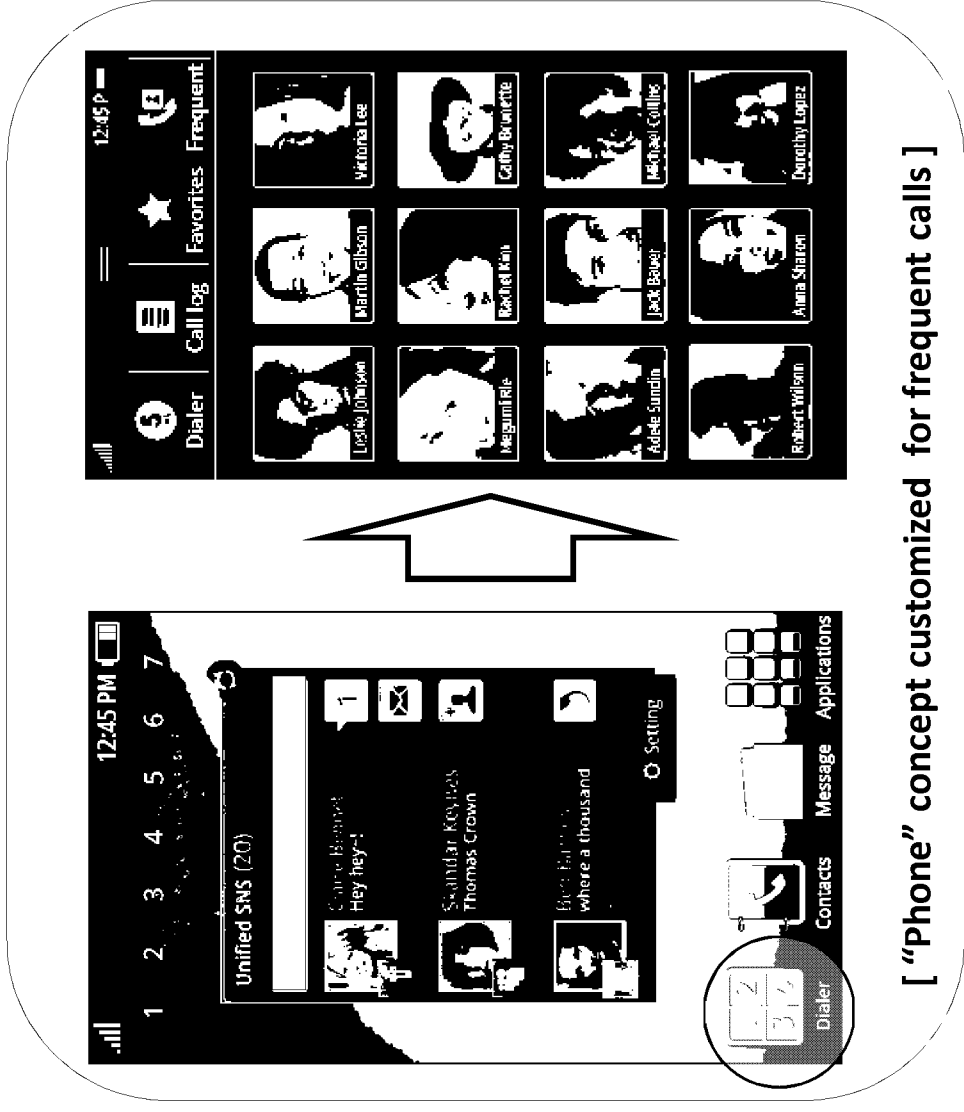
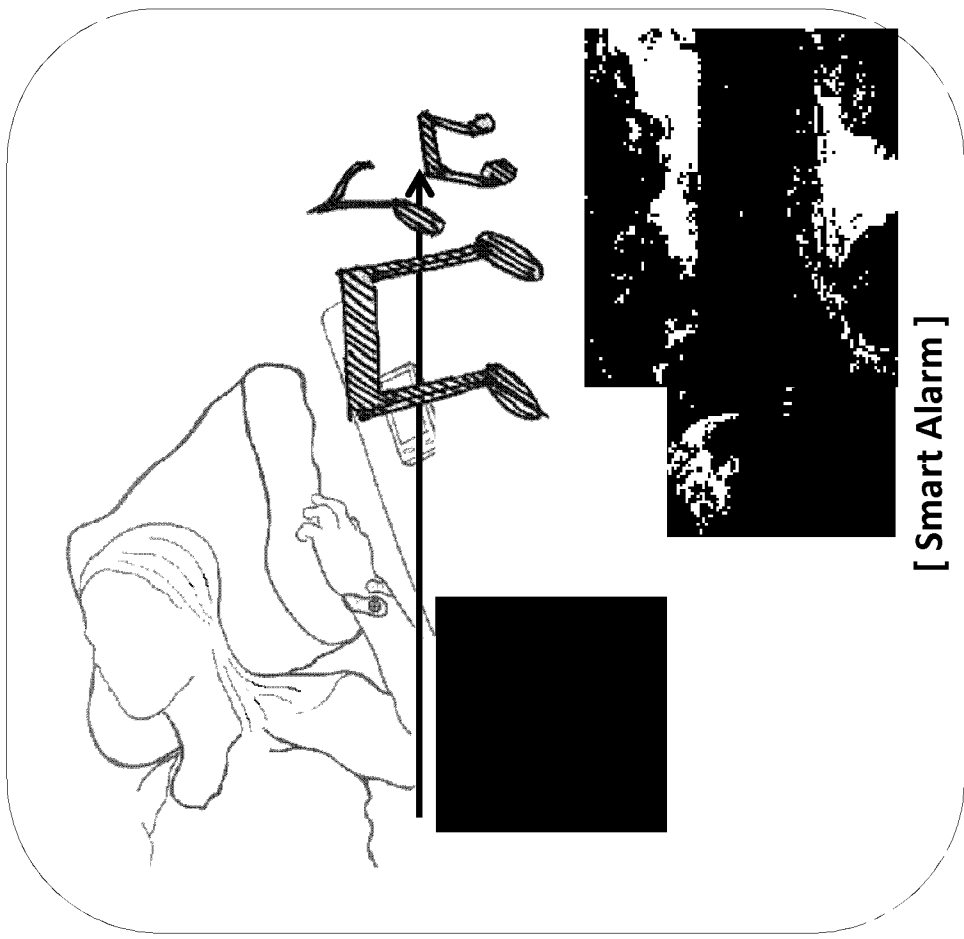

[ Smart Alarm ]

[ “Phone” concept customized for frequent calls ]

## 2. Sales Point – Augmented Reality

### *“Augmented Reality-based Social Browser”*

- ✓ Show User’s Surroundings & Display Information on Camera-view
- ✓ Global Core POI Information powered by Google Maps
  - Easy POI Search / More Accurate Search / Rich DB & Maintenance

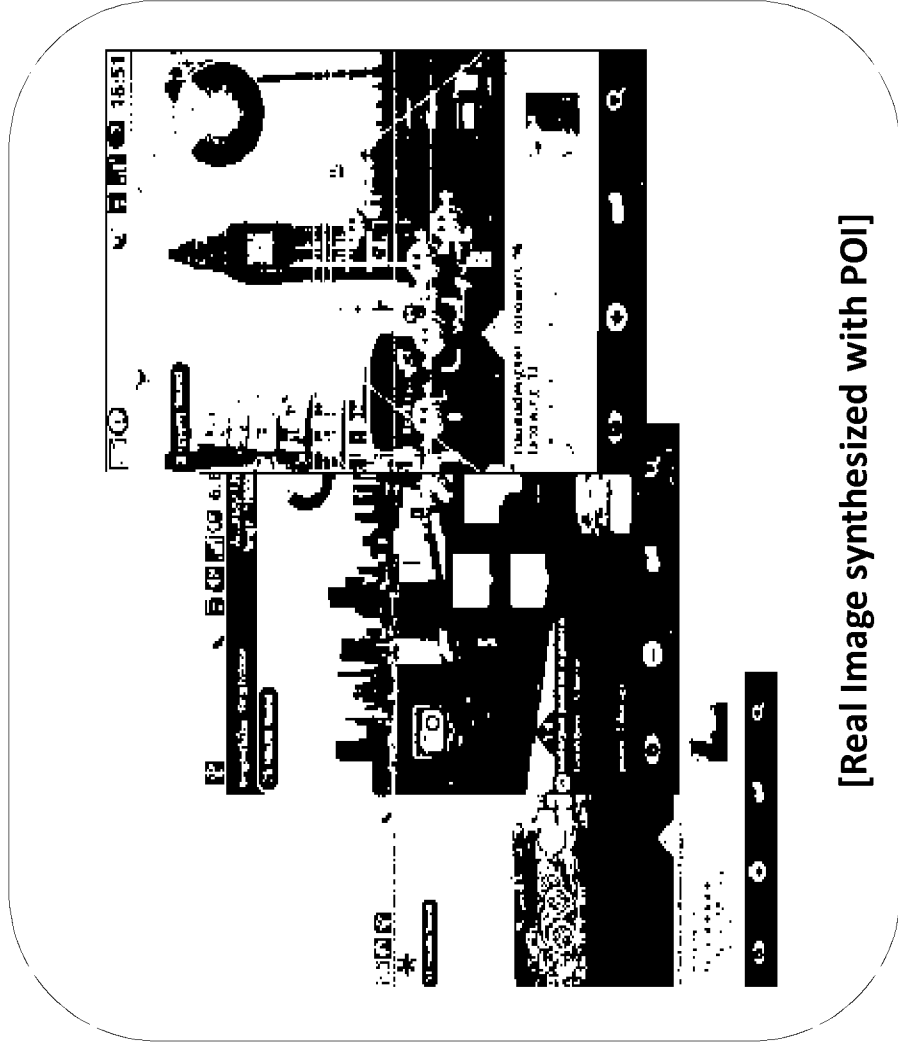

[Real Image synthesized with POI]

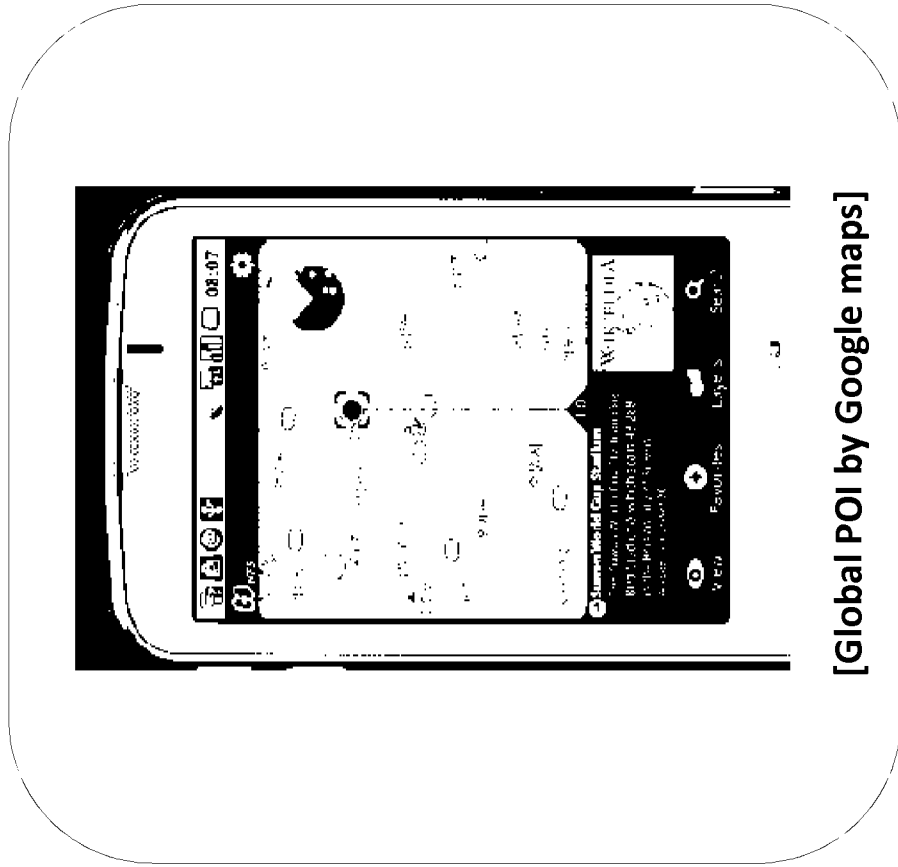

[Global POI by Google maps]

# 2. Sales Point - Convergence

CONFIDENTIAL

## “Center of Convergence with All-around Multimedia”

- ✓ Easy & Convenient Convergence powered by DLNA (AllShare)

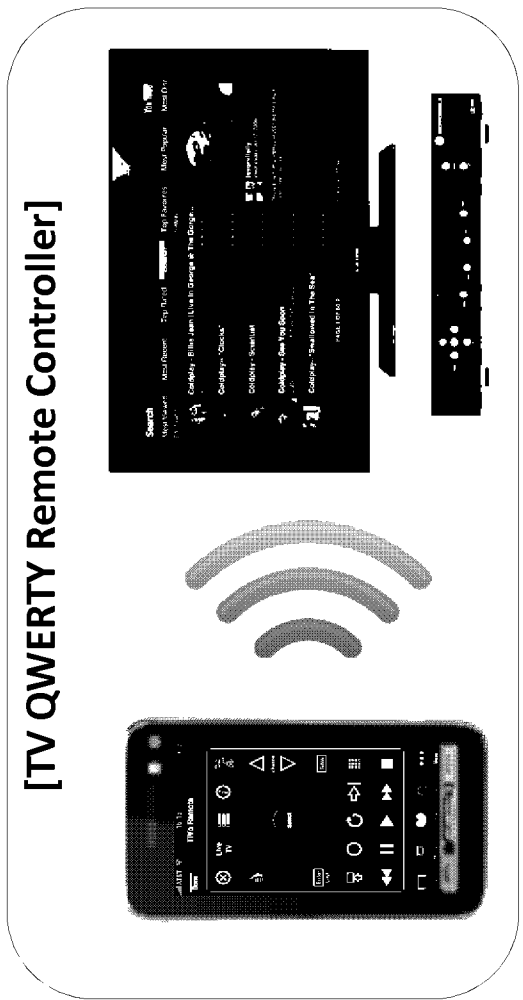
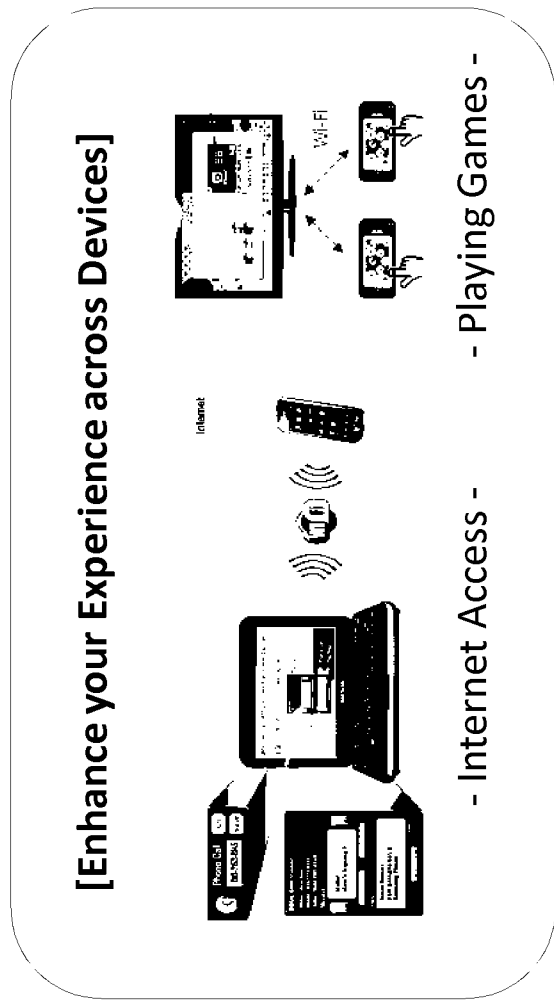
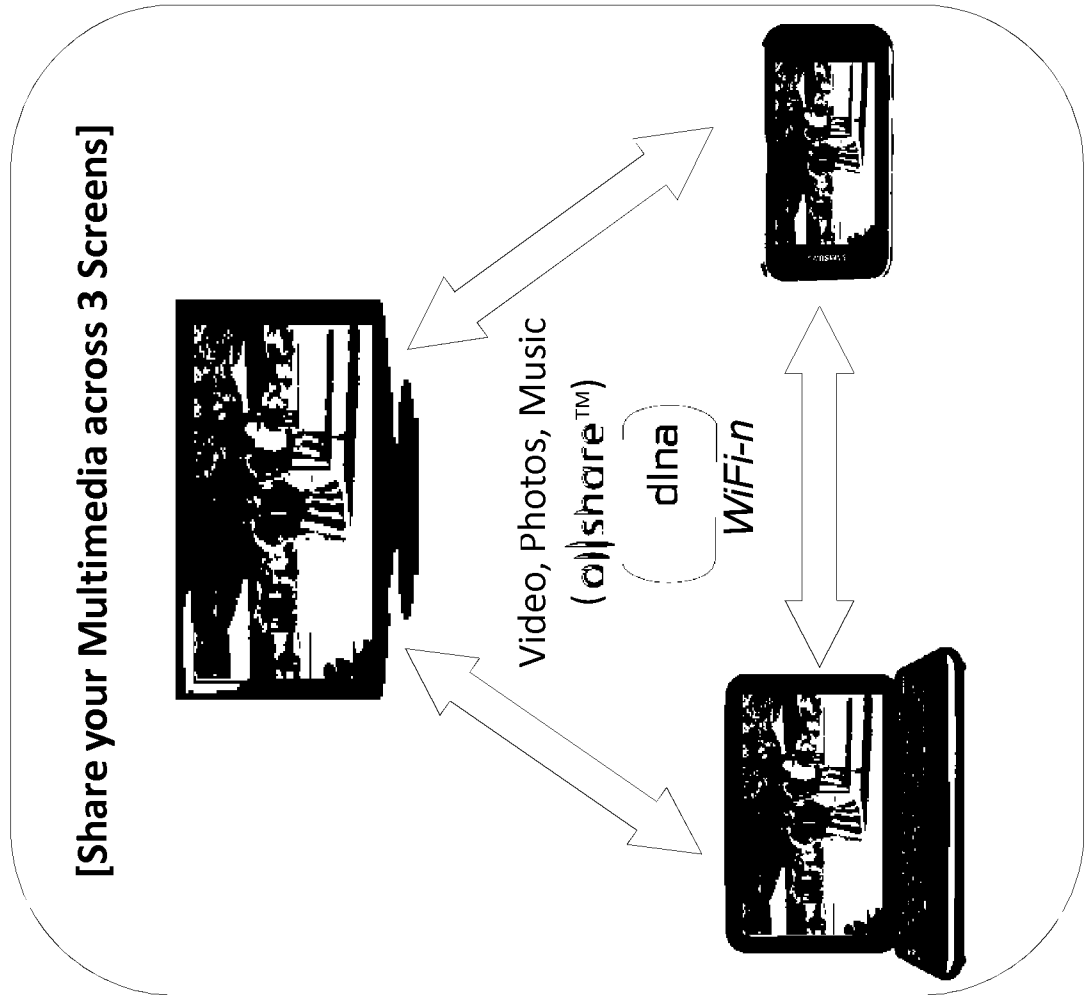

# 2. Sales Point - Advanced Features

## “Fun Multimedia Experience”

- Enhanced Camera Features for Perfect & Extraordinary Photos

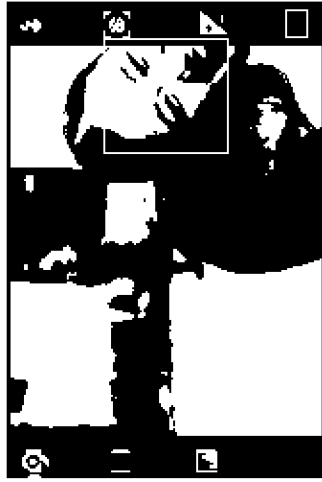

[Face Detection]

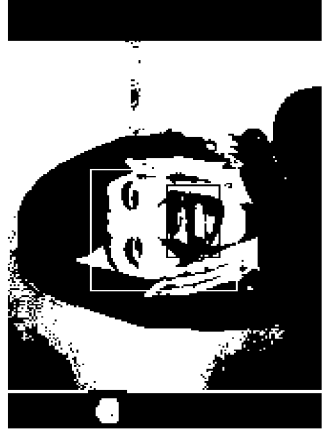

[Smile Recognition]

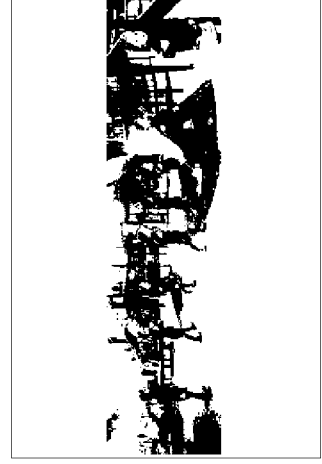

[Action shot]

## “Smart Security”

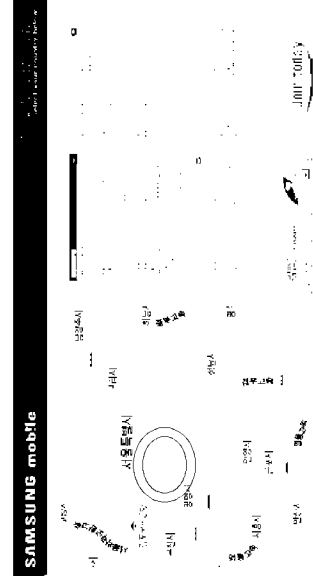

[Find Location]

- My Phone location on the map



[Remote Back-up & Remote Lock]

- Back-up my Data to Server  
- Lock or Wipeout my phone

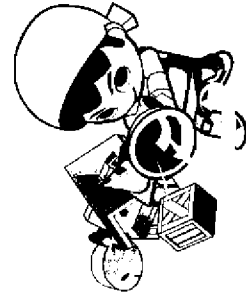

## “Expandable Connectivity”

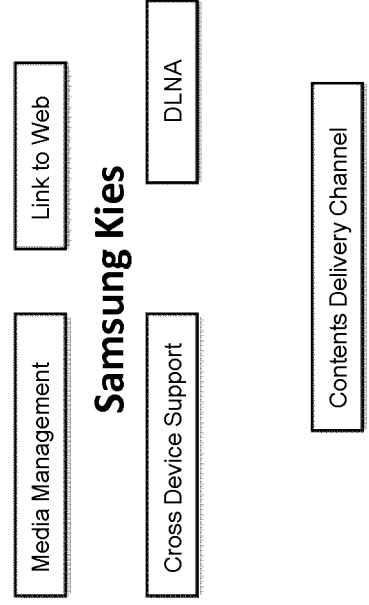

[Samsung Kies]

- PC Studio for Contents Management

# 2. Sales Point – E-book

## “Best In-class Reading Experience”

- ✓ E-Book Experience optimized for 4.0” Large OCTA LCD
- ✓ Convenient & Customized for Reading Books
- Customizable Themes, Easy Text search, and Intuitive Book list Management

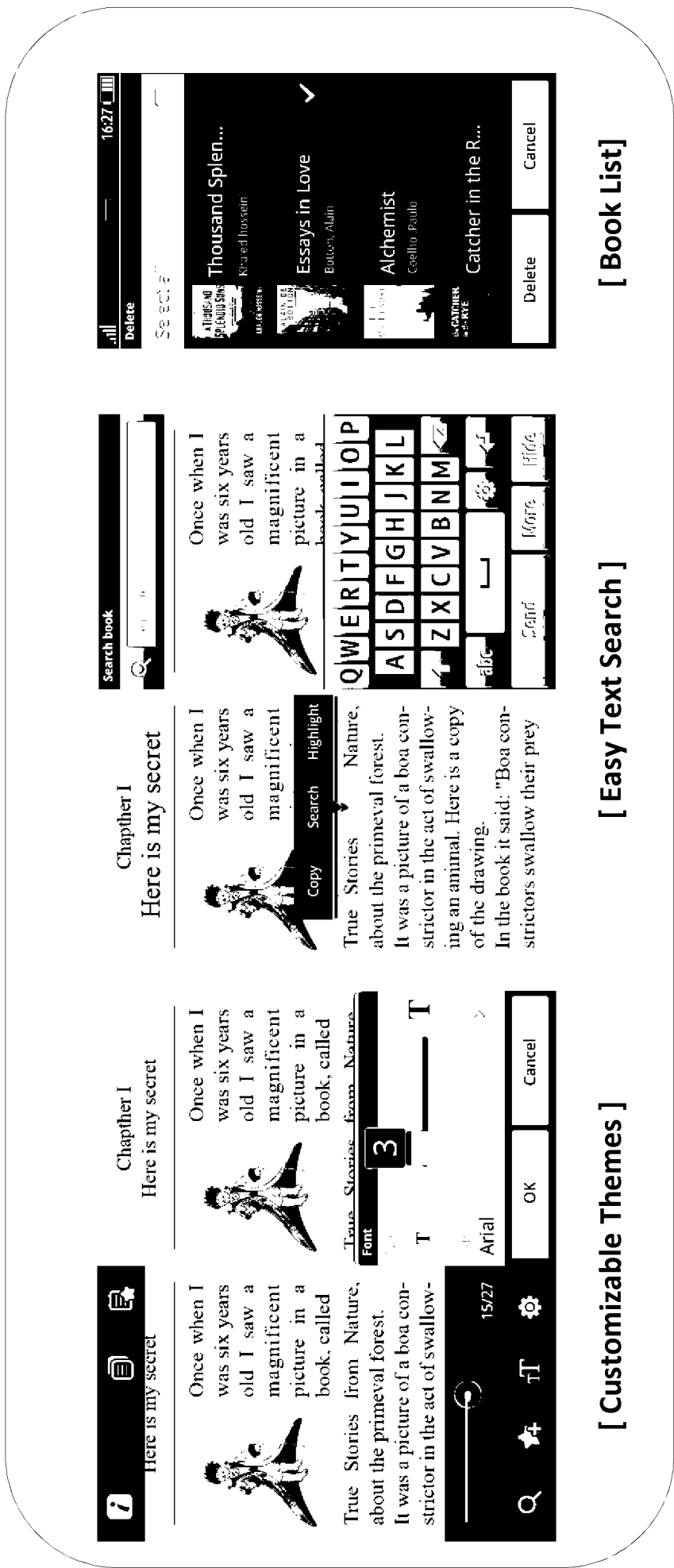



## 2. Sales Point – Aries-Q

### “Best Input Interface for Mobile Web”

- ✓ Touch + QWERTY : Most Preferred Input Interface of End-users
- ✓ Optimized UX for QWERTY-slide
  - Dedicated Key for “Write & Go”

#### Most Preferred Interface

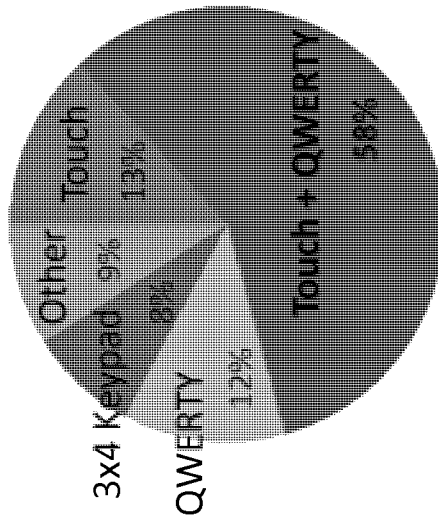

Q. What's your perfect mobile input interface?

#### QWERTY Optimized UX

- Dedicated Key for Write & Go

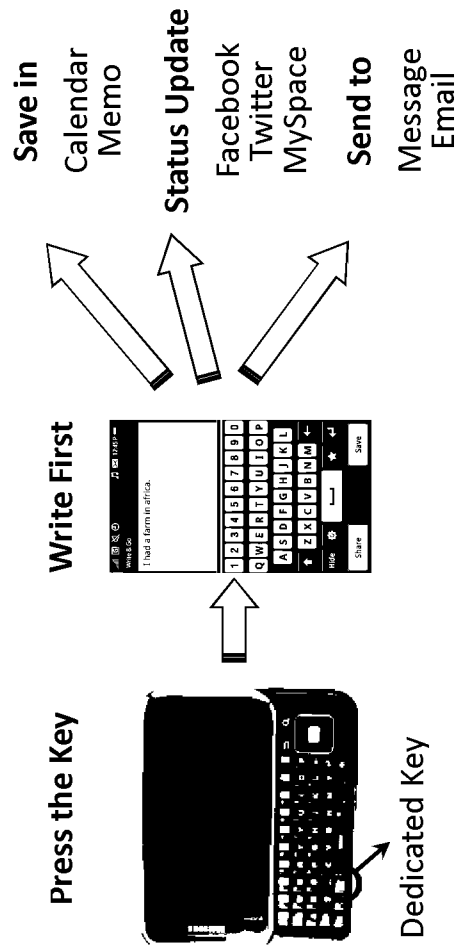





## 2. Sales Point - Accessories

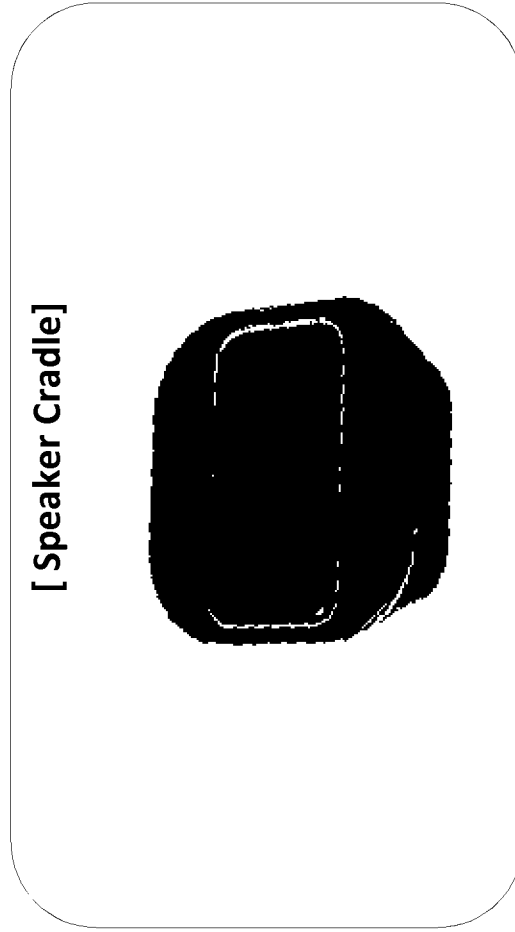
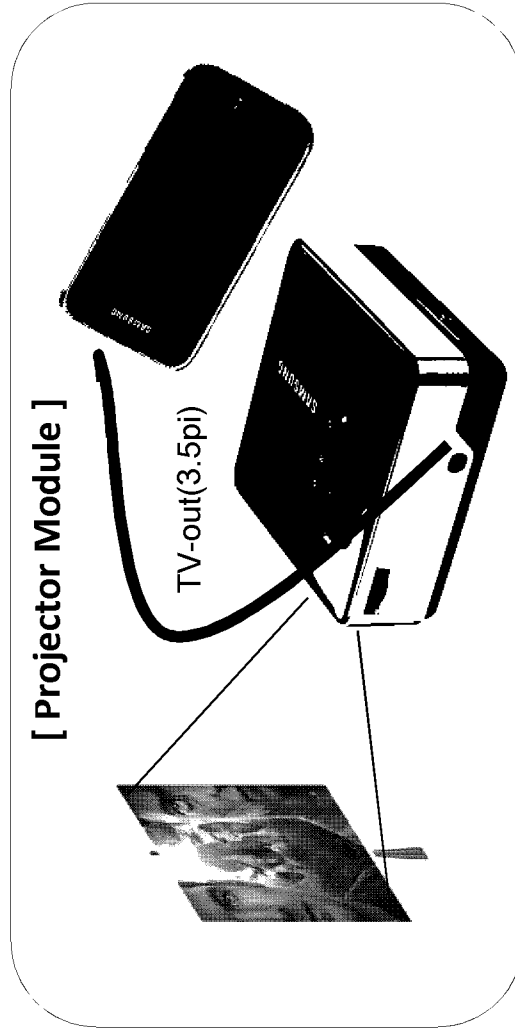

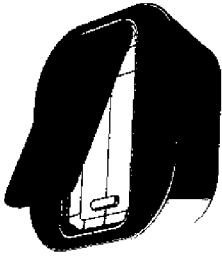
### “Fully ranged Accessories”

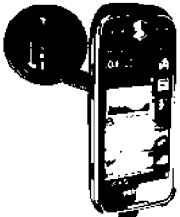
- ✓ A Variety of Accessories for Universal Multimedia Life
  - Dedicated Accessories: External Battery, Projector, Navigation Kit





Acc.	Speaker Dock Cradle	External Battery Pack	Navigation Kit	Projector	Portable Dock Cradle
Image					
Spec.	Charger/Data Sync Int.Batt(1,500mAh)	4,000 mAh Micro USB * 2EA	Car Cradle Suction Holder Car Charger	WVGA(480x800) Composite 2*1W SPK,2000 mAh	Charger/Data Sync Portable, Slim 1,500 mAh

### 3. Competitor comparison

	Aries (S1) (GT-19000)	NexusOne	iPhone 3G S
Design			
Launch	'10.05 (SRA기준)	'10.01	'09.06
Price(T/P)	€380 (16GB) / €350 (8GB)	€379 (R/P 기준)	€465(16GB) / €535(32GB)
OS	Android Éclair 2.1	Android Éclair 2.1	iPhone OS 3.0
Processor	S5PC111 (1GHz)	QSD8250 (1GHz)	S5PC100 (600 MHz)
Dimension	64.2 x 122.4 x 9.9 mm, 118 g	59.8 x 119 x 11.9 mm, 130 g	62.1 x 115.5 x 12.3 mm, 135 g
Band	GSM (850/900/1800/1900) HSUPA5.76 (900/1900/2100)	GSM (850/900/1800/1900) HSDPA 7.2 (900/2100)	GSM (850/900/1800/1900) HSDPA 7.2 (850/1900/2100)
LCD	4.0" WVGA (480x800) On-Cell AMOELD	3.7" WVGA (480x800) AMOLED	3.5" HVGA (320x480) TFT
Touch Type	C-type	C-type	C-type
Camera + Flash	5MP AF w/o LED Flash	5MP AF w/ LED Flash	3MP AF w/o LED Flash
Battery	1500 mAh	1400 mAh	1200 mAh
Memory	4Gb+3Gb+1Gb / MoviNAND 16GB microSD (upto 32GB)	4Gb + 4Gb / microSD 4GB microSD (upto 32GB)	4 Gb RAM / 16GB NAND Flash
Connectivity	BT 3.0, USB 2.0, GPS, WiFi 802.11 b/g/n microUSB, 3.5pi	BT 2.1, USB 2.0, GPS, WiFi 802.11 b/g microUSB, 3.5pi	BT 2.1, USB 2.0, GPS, WiFi 802.11 b/g microUSB, 3.5pi
Sensor	Accelerometer, Digital compass, Proximity, Light	Accelerometer, Digital compass, Proximity, Light	Accelerometer, Digital compass, Proximity, Light

### 3. Competitor comparison (당사)

	Aries(S1) (GT-I9000)	Kessler	Lismore (GT-S8500)
<b>Design</b>			
<b>Launch</b>	'10.05	'10.09	'10.04
<b>Price(T/P)</b>	€ 380	€ 380	€ 245
<b>OS</b>	Android Éclair 2.1	LiMo (Linux OS 2.6.29)	bada
<b>Processor</b>	S5PC111	S5PC111	S5PC111
<b>Dimension</b>	64.2 x 122.4 x 9.9 mm	66.9 x 124.8 x 9.9 mm	118 x 56 x 10.9 mm
<b>Band</b>	GSM (850/900/1800/1900) HSUPA 5.76 (900/1900/2100)	GSM (850/900/1800/1900) HSUPA 5.76 (900/1900/2100)	GSM (850/900/1800/1900) HSDPA 3.6 (900/2100)
<b>LCD</b>	4.0" WVGA (480x800) On-Cell AMOLED	4.3" WVGA (800x480) On-Cell AMOLED	3.3" WVGA (480x800) On-Cell AMOLED (Curved Glass)
<b>Touch Type</b>	C-type	C-type	C-type
<b>Camera + Flash</b>	5MP AF w/o LED Flash	5MP AF w/o LED Flash	5MP AF w/ LED Flash
<b>Battery</b>	1500 mAh	1500 mAh	1500 mAh
<b>Memory</b>	4Gb+3Gb+1GB / MovinAND 16GB microSD(up to 32GB)	4Gb+3Gb+1GB / MovinAND 16GB microSD(up to32GB)	4Gb+2Gb+1GB / MovinAND 8GB microSD(up to 32GB)
<b>Connectivity</b>	BT 3.0, USB 2.0, WiFi 802.11 b/g/n	BT 3.0, USB 2.0, WiFi 802.11 b/g/n	BT 3.0, USB 2.0, WiFi 802.11 b/g/n
<b>Sensor</b>	Accelerometer, Light, Proximity, Digital compass	Accelerometer, Light, Proximity, Digital compass	Accelerometer, Light, Proximity, Digital compass
<b>Video</b>	720p@30fps, DivX/XviD	720p@30fps, DivX/XviD	720p@30fps, DivX/XviD

# 4-1. Evaluation – Aries

디자인 평가 결과	8.1 (적합)
-----------	----------

구 분	평가결과		비 고
	점수	적합성	
디자인 외관	8	적합	<ul style="list-style-type: none"> <li>▶ 전면 하단부에 curved glass 적용하여 새로운 변화 시도</li> <li>▶ 후면 하단부는 전면과 반대값의 커브를 적용하여 연결성 있게 표현했으며 그립감을 좋게하고 바닥에 놓았을 때 포면을 보호함</li> </ul>
컬러/소재	8	적합	▶ 심플한 블랙 바디에 금속 테두리 적용으로 고급감을 더함
사용성	8.2	적합	▶ 크기에 비해 매우 슬림하며 하단 curve로 인해 키 조작 시 안정감 높음

문제점/이슈사항	조치사항
<ul style="list-style-type: none"> <li>▶ hanger hole, 카메라키, flash, mirror 없음</li> <li>▶ 볼륨키 상하 경계 구분 필요 - 각인 혹은 상하분리형 적용 (당사 표준안 참조)</li> </ul>	<ul style="list-style-type: none"> <li>▶ hanger hole 추가예정, 카메라키/flash/mirror는 디자인 및 사이즈 경쟁력을 위해 전략적으로 삭제(사업부장 컨펌, 1/19)</li> <li>▶ 볼륨키 상하 경계 구분 적용 예정</li> </ul>

# 4-1. Evaluation – Aries-Q

디자인 평가 결과	8.0(적합)
-----------	---------

구 분	평가결과		비 고
	8	적합	
디자인 외관	8	적합	<ul style="list-style-type: none"> <li>▶ 전면 하단부에 curved glass 적용하여 새로운 변화 시도</li> <li>▶ 후면 하단부는 전면과 반대값의 커브를 적용하여 연결성 있게 표현했으며 그림감을 좋게하고 바닥에 놓았을 때 포면을 보호함</li> <li>▶ 전면, 후면 삼성 로고 다소 작은 느낌</li> </ul>
컬러/소재	8	적합	<ul style="list-style-type: none"> <li>▶ 심플한 블랙 바디에 금속 디테일을 균형감 있게 적용하여 고급감을 더함</li> <li>▶ 유광과 무광의 적절한 대비로 고급스러움</li> </ul>
사용성	8	적합	<ul style="list-style-type: none"> <li>▶ 크기에 비해 매우 슬림하며 하단 curve로 인해 전면/QWERTY 키 조작 시 안정감 높음</li> </ul>

문제점/이슈사항	조치사항
<ul style="list-style-type: none"> <li>▶ hanger hole, 카메라키, flash, mirror 없음</li> <li>▶ 볼륨키 상하 경계 구분 필요 - 각인 혹은 상하분리형 적용 (당사 표준안 참조)</li> </ul>	<ul style="list-style-type: none"> <li>▶ hanger hole 추가예정, 카메라키/flash/mirror는 디자인 및 사이즈 경쟁력을 위해 전략적으로 삭제 (사업부장 컨펌, 1/19)</li> <li>▶ 볼륨키 상하 경계 구분 적용 예정</li> </ul>

## 4-2. Evaluation (Feature) – Aries

Feature 평가 결과		8.44 (+21.9%)
비교 대상 모델		iPhone 3GS
Image		
<b>비 고</b>		
상세 평가 결과	Instant Messenger, WAP browser, Changeable covers, Camera resolution, Camera extra features, Video resolution, BT version, BT profile, WiFi extra features, Display type/resolution/diagonal, Audio codec, FM radio, Memory card slot/max capa, JAVA, Games, In-box acc.	
우세항목	19	
열세항목	1	Multi-language

<b>문제점/이슈사항</b>		<b>조치사항</b>
- Multi-language		- 현재 iPhone(30개 언어) 대비 Aries(14개 언어, Samsung XT9 Keyboard 기준)가 열세이나, 15개 Locale 추가 개발 중이며 추후 확대 검토

# 4-3. Evaluation (Service) – Aries

Service 평가 결과		8.2 (▲10%)
비교 대상 모델		iPhone 3GS
Image		
상세 평가 결과		
우세항목	5	비 고 우세 : SNS, IM, Widget, Kies 동등 : Video, E-book
열세항목	2	Photo-upload Application, Android Market
문제점/이슈사항		조치사항
- Appstore 대비 Android Market 열세		<ol style="list-style-type: none"> <li>1) Google에서 2010년 2분기에 Android Market을 Global Promotion 할 계획임</li> <li>2) Samsung 차별화 가능한 More Widgets 탑재하여 Local 소비자 Needs에 대응</li> <li>3) Android Market을 사용할 수 없는 국가에서는 Slideme 탑재하여 Android Market의 대체 Marketplace 제공</li> </ol>



# 5-1. H/W Spec.

Category	Description
B/B Chipset	IFX6160
Standard	HSUPA 5.76 Mbps, HSDPA 7.2 Mbps EDGE/GPRS Class 12
RF Band	Tri band UMTS 900/1900/2100 Quad band GSM 850/900/1800/1900
Additional Chip	S5PC111 (1GHz)
Dimension	Aries: 64.2 x 122.4 x 9.9 mm Aries-Q: 64.2 x 126 x 13.5 mm (수동, PK)
Display	4.0" WVGA On-Cell AMOLED, C-type touch
Camera	5M AF
Flash	N/A
Memory	4Gb+3Gb+1Gb, 16GB MovINAND
Ex. Memory	microSD (upto 32GB)
Antenna	Integrated Antenna
SIM	Sliding Type, 3V Only

Category	Description
Battery	Li-polymer 1500mAh
- STD time	250H (@PP2)
- Talk time	5H (@PL5)
Connectivity	WiFi 802.11 b/g/n USB 2.0 H/S BT v3.0
IF Connector	microUSB
Speaker	Size : 1115 SPK/RCV : 분리형 12x07 공명 공간 : 0.625 cc 음량 기준 : 신뢰성 65dB
Ear Jack	Φ3.5 4극
CMF	Front : 강화유리 Rear : PC사출 Main Color : Noble Black
VPS	Package : Batt., Manual, TA, Earphone etc Option : Car charger, BT headset, Data cable
User Benefit	- 4.0" Large Super AMOLED optimized for Enhanced Outdoor Visibility & HD Experience - 9.9t Ultra Slim for Comfortable Hand Grip - Large 1500 mAh Batt. for Long Multimedia Experience

# 5-2. S/W Spec.

Category	Description
OS	Android Éclair 2.1
Message	SMS / MMS(OMA v 1.2) E-mail (POP3/IMAP/SMTP) Exchange ActiveSync E-mail (Push e-mail)
Codec	- Audio : MP3, OGG, AAC, AAC+, eAAC+, AMR-NB, WMA, WAV, MID, AC3, IMY, AAC(Mono), AMR_NB -Video : . Codec: Mpeg4, H.264, H.263, H263Sorenson, Divix/XviD, VC-1 . Format: 3gp(mp4), wmv(asf), avi(divx), mkv, flv Image : JPEG, PNG, GIF, WBMP, BMP, AGIF
WAP	No support of WAP in android Chrome Lite Browser, HTML 5.0 HTTP, OTA provisioning supported
GPS	A-GPS (SUPL지원)
JAVA (JSR's)	사업자의 요청에 따라서 가변적으로 적용
DRM	OMA DRM 1.0 Full (FL, CD, SD), WM DRM/ MTP (SEUK 향)

Category	Description
Bluetooth	<ul style="list-style-type: none"> <li>▪ Bluetooth v3.0</li> <li>▪ Profile : GAP, SSP, SDAP, HSP, HFP1.5, A2DP, AVRCP, SPP, DUN, FTP, SAP, BPP, OPP, PBAP</li> </ul>
SyncML	MS Outlook Exchangeable SyncML DS v1.2, SyncML DM v1.2, FOTA
Others	<ul style="list-style-type: none"> <li>▪ TouchWiz 3.0</li> <li>. Homescreen, Hybrid Widgets</li> <li>▪ Integrated Messaging</li> <li>▪ Google Mobile Services</li> <li>▪ Kies, DLNA, FM Radio</li> <li>▪ Media Browser, Photo Editor, Write &amp; Go</li> </ul>
User Benefit	<ul style="list-style-type: none"> <li>▪ TouchWiz 3.0 UX                             <ul style="list-style-type: none"> <li>. 7 home screens &amp; editable menu</li> <li>. Hybrid widgets</li> </ul> </li> <li>▪ Stay connected with friends in real time                             <ul style="list-style-type: none"> <li>. Integrated Contact with SNS, IM, Email</li> </ul> </li> <li>▪ Sync with PC, Mobile and Social Event                             <ul style="list-style-type: none"> <li>. Integrated Calendar</li> </ul> </li> <li>▪ Push Service (SNS, Email, IM)</li> <li>▪ Easy Photo Management with Media Browser</li> <li>▪ VT Call for Android</li> </ul>

# 5-2. S/W Spec.(기술료 지급 기능)

## 적용 계획

구 분	Category Guide (52종)	적용 계획 (13종)
기본 기능	Pocket PC/Smartphone, MS Active Sync, MMV, QVM, MPEG-2 SYSTEM H.264 AVC, JAVA, Vsuite, Global 지도, NDIS, MTP/PTP/DFU, SS, Smile/blink Detection, ArcSoft Video Editor, Codec package Audio amp, 3D 그래픽, Flashplayer, 진동솔루션, Browser DIVIX, Music ID(음원 인식), Media Player, Aricent(Emuzed), UMA-compliant moWLAN Navigation SW, Kastor Engine, Rich media, Open SVG 솔루션, 동영상 편집 Dataviz Activesync, 3D sound/중저음보강, USB Driver, EA 게임 타이틀, SyncML/ FOTA WAP Browser, Caps Engine, Digital Bridges 게임 타이틀, Caps Engine, AlexVG Engine/Player ARICENT 동영상 코덱, OMA DRM, Photo Slides / Zoomer, Flashplayer, UMA-compliant MoWLAN Localization, 스텝하우스 게임 컨텐츠, MBX Core (3D Graphic Accelerator), e-photo, DRM / JAVA / Music / Video Game(Asphalt4), 러시아어 인식 및 사전기능	MPEG-2 System, H.264 AVC, JAVA, Vsuite, Smile/Blink Detection, JTEK, Flashplayer, 진동 솔루션, 동영상 코덱, 문서 뷰어/편집기, SyncML/FOTA, Caps Engine, AlexVG Engine/player
신규/추가 기능		Layar, Evernote, Flipfont, Bump

## 신규/추가 기능

신규/추가 기능	기능 개요	적용 사유
Layar	Augmented Reality browser	- Galaxy 탑재시 현지 소비자 반응 좋음
Evernote	Web-based Note	- User note 기능 강화
Flipfont	Font 변경	- Android용 font변경 차별화 가능
Bump	명함 교환 기능	- Fun function

## 5-2. S/W Spec.(기술로 지급 기능)

CONFIDENTIAL  
L

### 적용 계획

구 분	Category Guide (52종)	적용 계획 (13종)
기본 기능	Pocket PC/Smartphone, MS Active Sync,MMV,QVM,MPEG-2 SYSTEM H.264 AVC, JAVA, Vsuite, Global 지도, NDIS, MTP/PTP/DFU, SS, Smile/blink Detection, ArcSoft Video Editor, Codec package Audio amp, 3D 그래픽, Flashplayer, 진동솔루션, Browser DIVIX, Music ID(음원 인식), Media Player, Aricent(Emuzed), UMA-compliant moWLAN Navigation S/W, Kastor Engine, Rich media, Open SVG 솔루션, 동영상 편집 Dataviz Activesync, 3D sound/중저음보강, USB Driver, EA 게임 타이틀, SyncML/FOTA WAP Browser, Caps Engine, Digital Bridges 게임 타이틀, Caps Engine, AlexVG Engine/Player ARICENT 동영상코덱, OMA DRM, Photo Slides / Zoomer, Flashplayer, UMA-compliant MoWLAN Localization, 스티하우스 게임 콘텐츠, MBX Core (3D Graphic Accelerator), e-photo, DRM / JAVA / Music / Video Game(Asphalt4), 러시아어 인식 및 사진기능	MPEG-2 System, H.264 AVC, JAVA, Vsuite, Smile/Blink Detection, JTEK, Flashplayer, 진동 솔루션, 동영상 코덱, 문서 뷰어/편집기, SyncML/FOTA, Caps Engine, AlexVG Engine/player
신규/추가 기능		Layar, Evernote, Flipfont, Bump

### 신규/추가 기능

신규/추가 기능	기능 개요	적용 사유
Layar	Augmented Reality browser	- Galaxy 탑재시 현지 소비자 반응 좋음
Evernote	Web-based Note	- User note 기능 강화
Flipfont	Font 변경	- Android용 font변경 차별화 가능
Bump	명함 교환 기능	- Fun function

NDIS: Mac PC용 ACM Modem Driver/NDIS Driver

# 5-4. UX 관련

## Aries UX 적용계획

### 차별화 포인트

#### Basic

- 1. Android OS UI 기반  
: Basic component,  
pop-up, settings,  
wireless controls
- 2. 삼성 TouchWiz 3.0  
UI 적용

#### New features

- 1. Enhanced SNS UX
  - Integrated phonebook & Calendar 지원
  - Media browser에 Online album 추가
  - Push event지원 (Email, SNS activities), IM지원
- 2. New widgets
  - Buddies now, hybrid clocks, Daily briefing ...
- 3. 부가 기능 추가
  - Multi-media UX for a fun (Add me, Action shot, Stop motion),  
Write & Go

## New Features

### 1. Enhanced SNS UX

Integrated phonebook

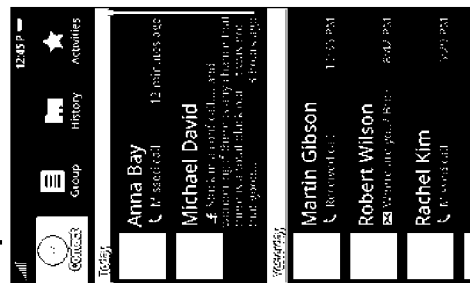

Integrate Calendar with SNS

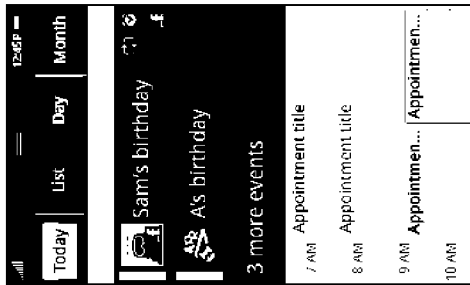

Online media album

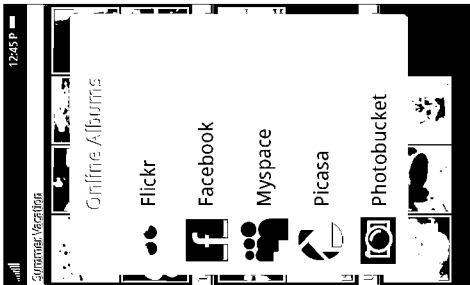

### 2. New widgets

Buddies now

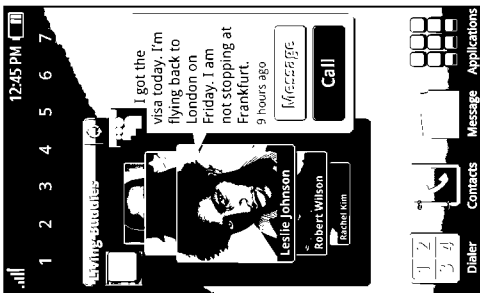

Hybrid clock

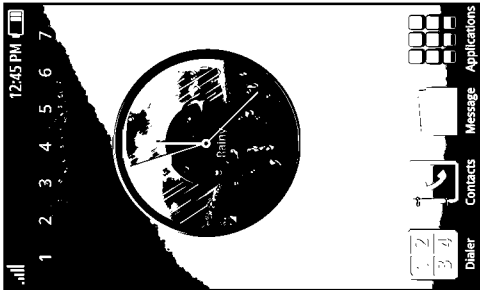

Daily briefing



### 3. 부가 기능 차별화

Action shot

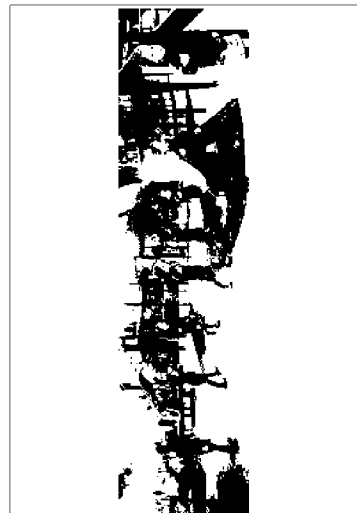

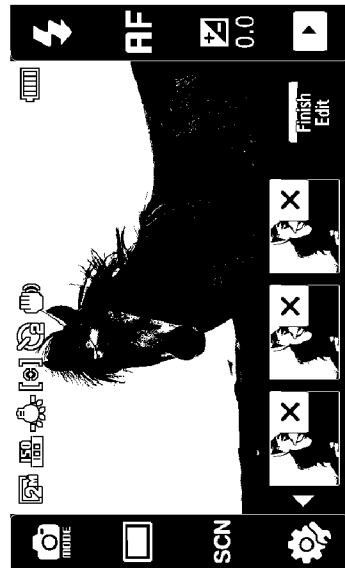

Stop motion



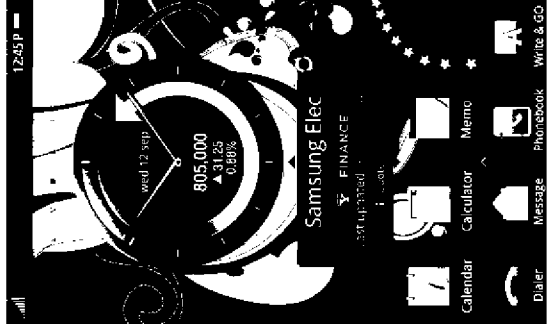
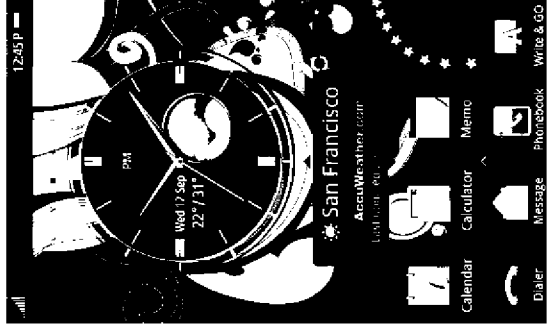
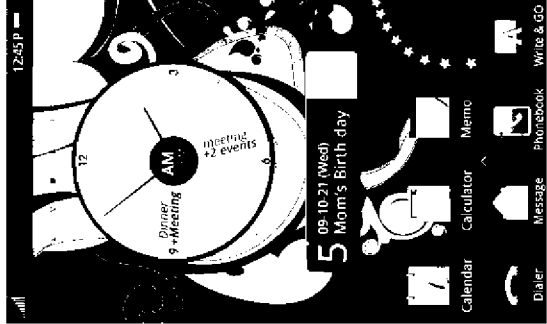
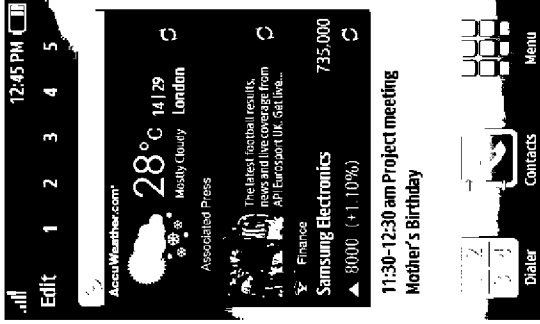

# 5-4. Service Spec.

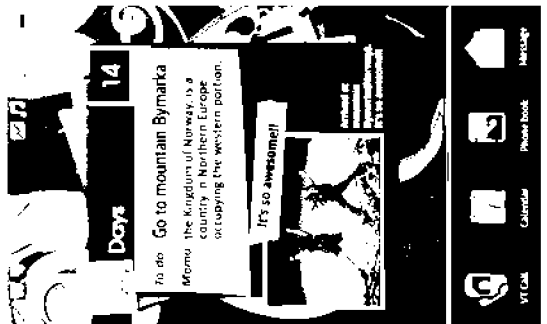
CONFIDENTIAL

Category	Description
<p>Widget for Android</p>	<p><b>Hybrid Widgets</b></p> <ul style="list-style-type: none"> <li>- Display Multiple Information on single Widget</li> <li>- Hybrid Clock (Clock + Weather, Finance, Calendar)</li> <li>- Daily Brief (Alarm + Weather, News, Stock...)</li> <li>- Days (Photo diary on my hand)</li> </ul> <p><b>eRobert Parker</b></p> <ul style="list-style-type: none"> <li>- World famous wine vintage guide</li> </ul>
<p>2.5</p>	<p><b>Hybrid Clock</b></p>    <p><b>Daily Brief</b></p>  <p><b>eRobert Parker</b></p>  <p><b>Days</b></p> 

\* UI screenshot may change

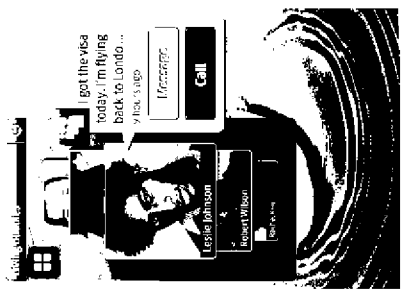
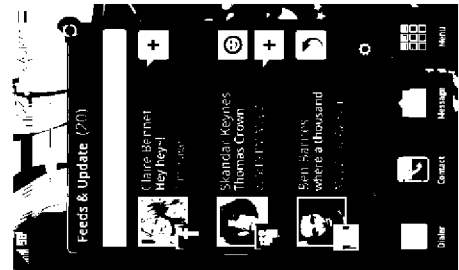
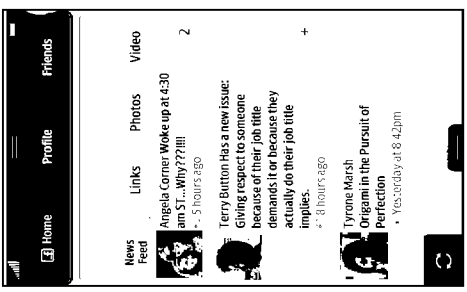
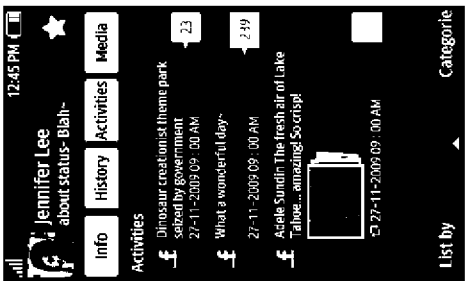
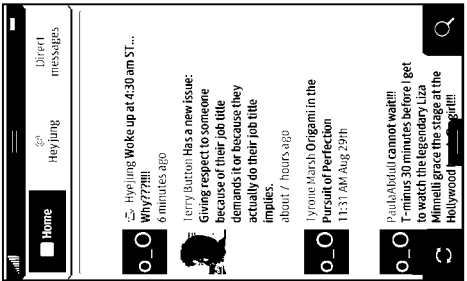



# 5-4. Service Spec. (Cont'd)

Category	Description
<p>SNS</p> <p>4.0</p>	<p><b>Phonebook integration</b></p> <ul style="list-style-type: none"> <li>-User can check SNS feeds on the phonebook and comment on them directly from the phonebook.</li> <li>-Person-centric network/communication service will be provided on an application.</li> </ul> <p><b>Unified feeds and update</b></p> <ul style="list-style-type: none"> <li>- Multiple SNS on single widget (Facebook, Twitter, MySpace)</li> <li>- Display feeds and update my status on single widget</li> </ul> <div style="display: flex; justify-content: space-around;"> <div style="text-align: center;">  </div> <div style="text-align: center;">  </div> </div> <p style="text-align: center;"><b>SNS Widgets</b></p> <div style="display: flex; justify-content: space-around;"> <div style="text-align: center;">  </div> <div style="text-align: center;">  </div> </div> <p style="text-align: center;"><b>Phonebook Integration</b></p> <div style="text-align: center;">  </div> <p style="text-align: center;"><b>SNS Applications</b></p> <div style="text-align: center;">  <p>myspace.com</p> </div>

\* UI screenshot may change

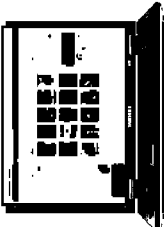
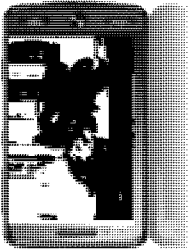

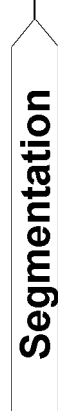
# 5-4. Service Spec. (Cont'd)





Category	Description
<p><b>Video</b></p> <p><b>1.0</b></p>	<p><b>Samsung Movies (Online Video Store)</b></p> <ul style="list-style-type: none"> <li>- Full-length movies &amp; TV shows for Download to Own/ Download to Rent</li> <li>- Mobile version available to be side-loaded to device</li> </ul> <div style="display: flex; justify-content: space-around; align-items: center;"> <div style="text-align: center;">  <p>Browse &amp; Download</p> </div> <div style="text-align: center;">  <p>Side-load to device &amp; Watch</p> </div> </div>
<p><b>Game</b></p> <p><b>2.0</b></p>	<ul style="list-style-type: none"> <li>• <b>Full Embedded Game : Tetris refresh</b></li> <li>- Consumers enjoy Full embed game for free</li> </ul> <div style="display: flex; justify-content: space-around; align-items: center;"> <div style="text-align: center;">  <p>Localization</p> </div> <div style="text-align: center;">  <p>Segmentation</p> </div> <div style="text-align: center;">  <p>Feature maximizer</p> </div> </div>

# 5-4. Service Spec. (Cont'd)

Category	Description
<p><b>Calendar Integration</b></p>	<p><b>Social Calendar</b></p> <ul style="list-style-type: none"> <li>- Real-time 2 way sync with Google and Yahoo</li> <li>- Get event from facebook</li> <li>- Supporting EAS calendar sync feature</li> <li>- Calendar 1.0 + facebook, Yahoo, Google</li> </ul> <div data-bbox="418 107 755 830" style="border: 1px solid black; border-radius: 15px; padding: 10px; margin: 10px 0;"> </div> <div data-bbox="763 161 1356 1530" style="border: 1px solid black; padding: 10px;"> <p>The screenshots illustrate the calendar application's user interface. The top row shows three views: a 'List' view with a calendar grid, a 'Day' view showing a single day's events, and a 'Month' view showing a monthly calendar. The bottom row shows a 'Detail view' for an event titled 'Garden party' and a 'Create Event' screen with fields for 'From', 'To', 'Calendar', and 'Location'.</p> </div>

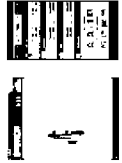
\* UI screenshot may change

# 5-4. Service Spec. (Cont'd)

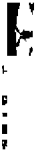
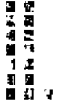
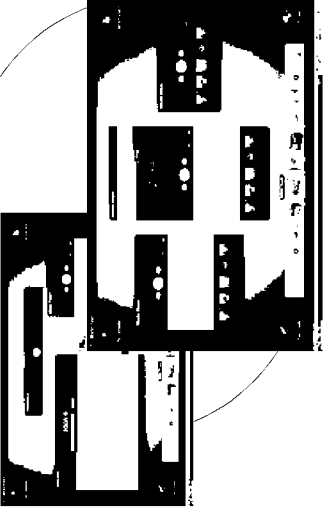
Category	Description
<p><b>Kies 1.5</b></p>	<ul style="list-style-type: none"> <li>- Samsung Kies is an integration PC SW for Samsung Digital Devices</li> <li>- Easy Data Backup/Sync, Contents Management</li> <li>- Contents Delivery Channel (Music/Video/Application)</li> <li>- Cross-Device Content Share through DLNA</li> <li>- User Beneficial Features</li> <li>- PC : Support Windows XP/Vista/7</li> </ul> <div style="display: flex; justify-content: space-around; align-items: center;"> <div style="text-align: center;"> <p><b>PC SW for Mobile handset</b></p> <p>PCStudio (GSM) </p> <p>PCLink, PMP (CDMA) </p> <p>PC Manager </p> <p>NPS (HHP) </p> </div> <div style="text-align: center;"> <p><b>PC SW for digital device</b></p> <p>EmoDio (MP3P) </p> <p>Samsung Master(DSC) </p> <p>Cyberlink (Camcorder) </p> <p>AV Station (PC) </p> </div> </div> <div style="text-align: center; margin-top: 20px;"> <p><b>Samsung kies</b></p>  </div> <ul style="list-style-type: none"> <li>- Integrate PC SW</li> <li>- Improve usability with user-friendly interface</li> </ul>

# 5-5. CMF Spec. - Aries

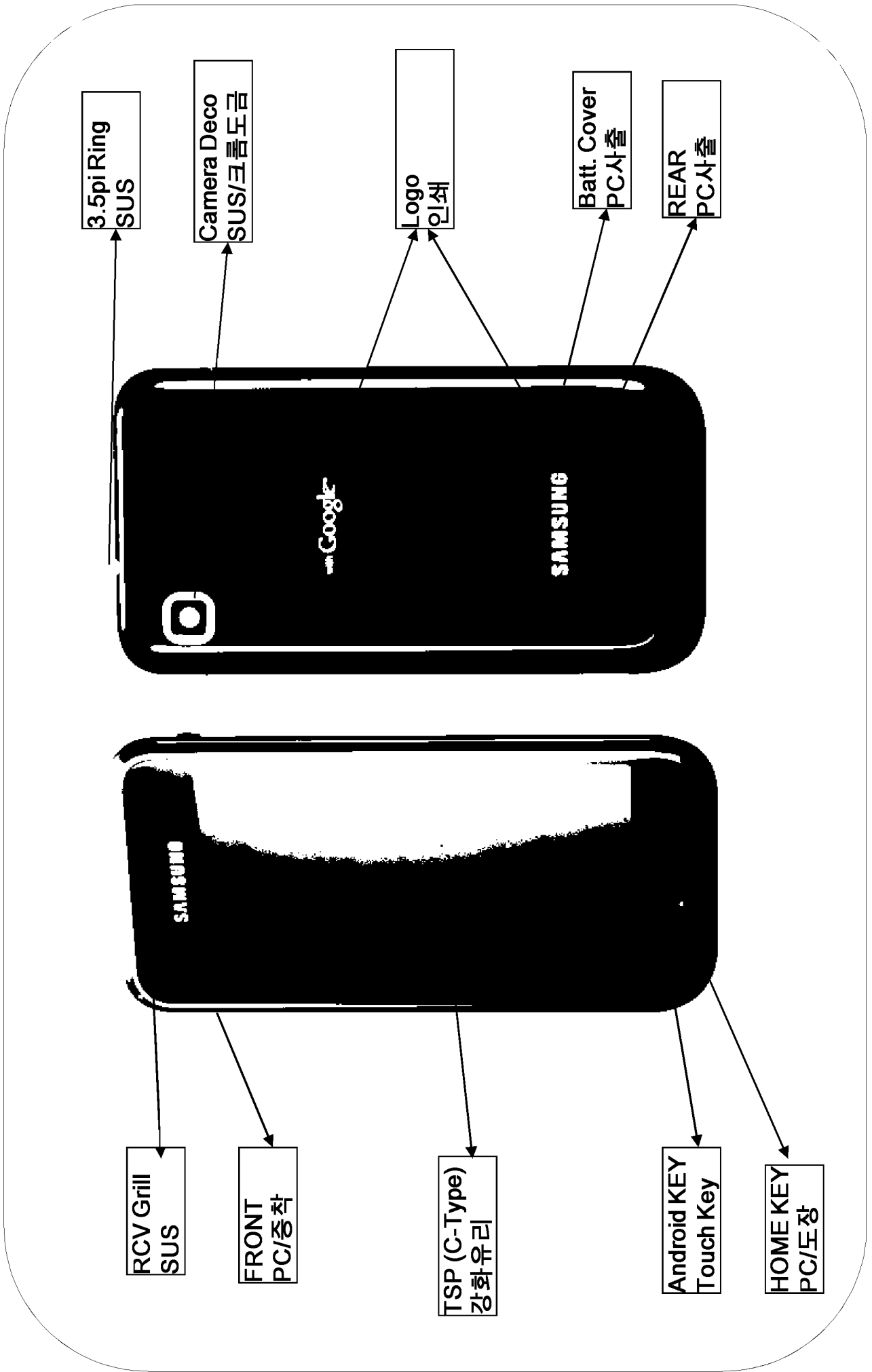

# 5-5. CMF Spec. – Aries-Q

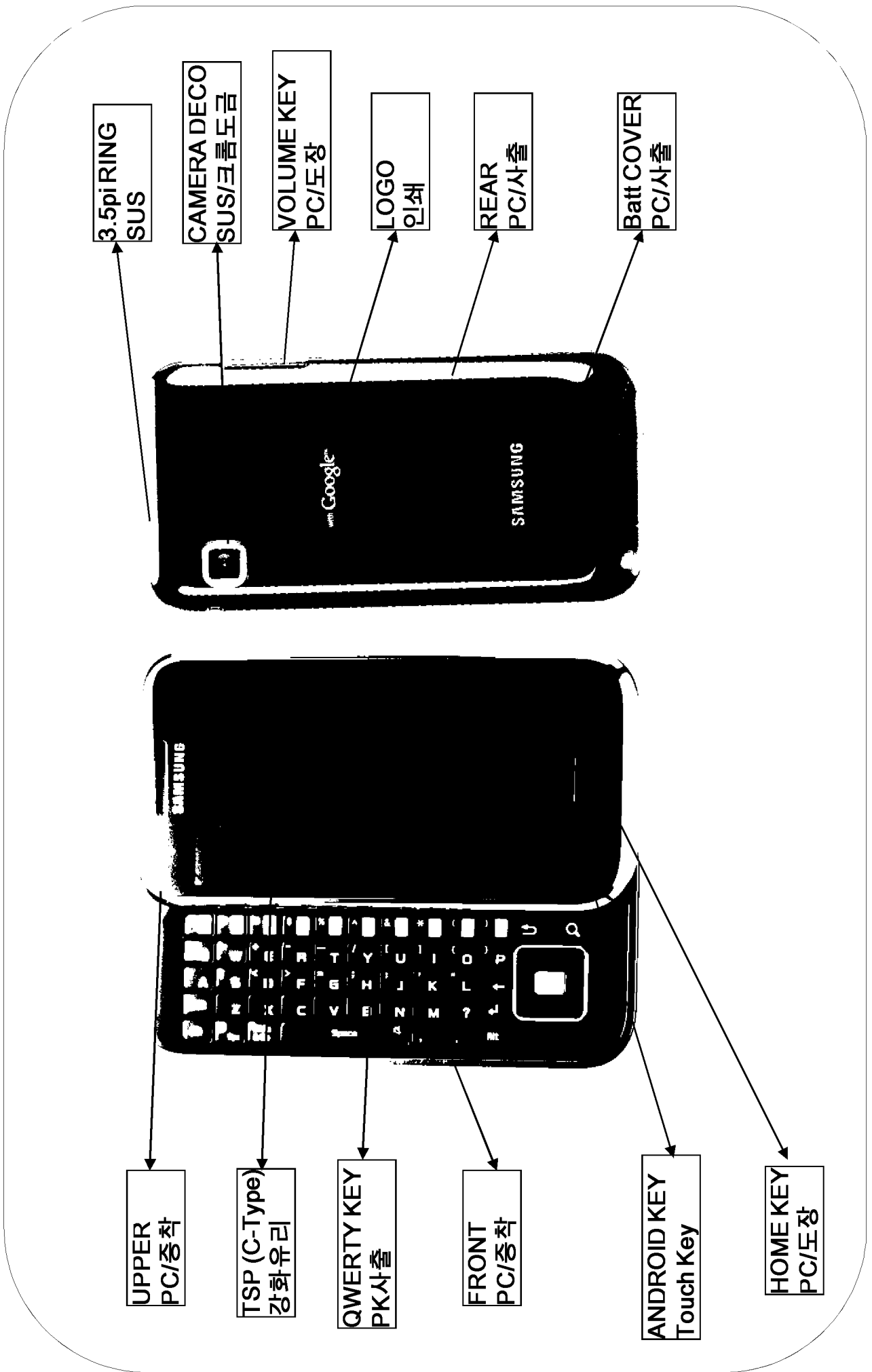













## 5-6. 과제 점검 Check-list

### 개발 PL 발표

- 주요 이슈 사항 위주로 발표

# 6. VPS

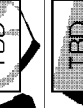
CONFIDENTIAL

	Item	Spec.	Image	Remark	재료비	판매가(목포)
<b>Package</b>	Standard Battery	Li-Polymer, 1500mA		Common	\$3.31	
	Manual (Quick guide+Manual)	- User guide - PC Suite user guide - CD Installer		English 1EA	\$0.30	
	Travel Adapter	microUSB		Common	\$1.14	
	Earphone	EHS60 In-canal Stereo 3.5mm 4p, Mini Mic		Common	\$1.25	
	Data Cable	microUSB		Common	\$0.40	
	B/T Headset (Mono)	HM3100		Common	-	\$49.9
<b>Option</b>	B/T Headset (Stereo)	SBH650		Common	-	\$89.9
	Wired Speaker	SP100 2 * 2 Watt		Common	-	\$29.9
	Speaker Dock Cradle	2 * 1 Watt 1,500 mAh		Dedicated	-	\$45.9
	Portable Dock Cradle	1,500 mAh		Dedicated	-	\$34.9
	Navigation Kit	- Car Cradle - Suction Holder - CLA		Dedicated	-	\$44.9
	External Battery Pack	4,000 mAh Micro USB		Common	-	\$69.9
	Mobile Beam Projector	MBP110 WVGA(854*480) 2,000mAh, TV-out & HDMI		Common	-	\$249.9

## 7. Target Sales Volume, Price and Profit

Aries

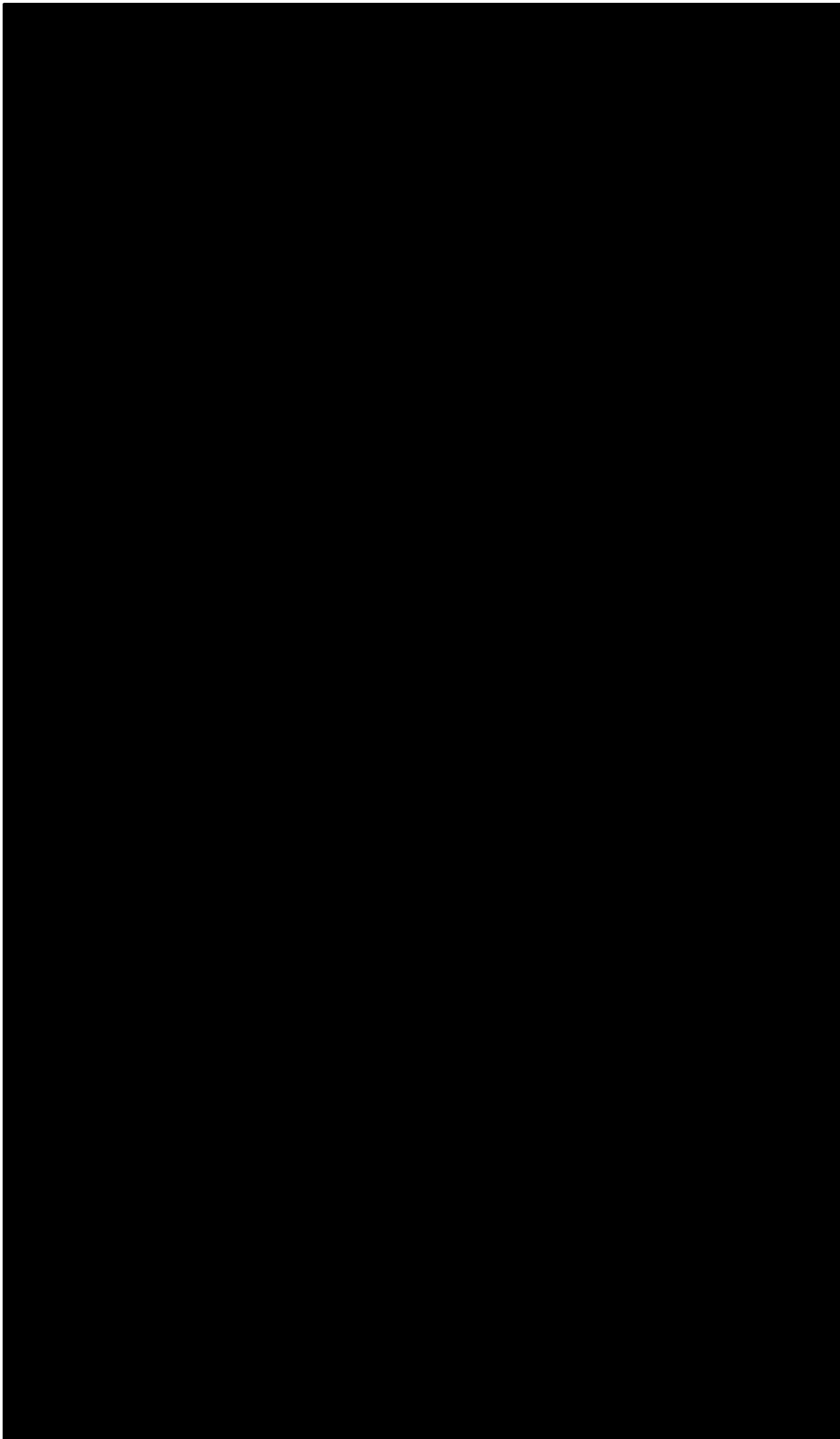



## 7. Target Sales Volume, Price and Profit

Aries-Q

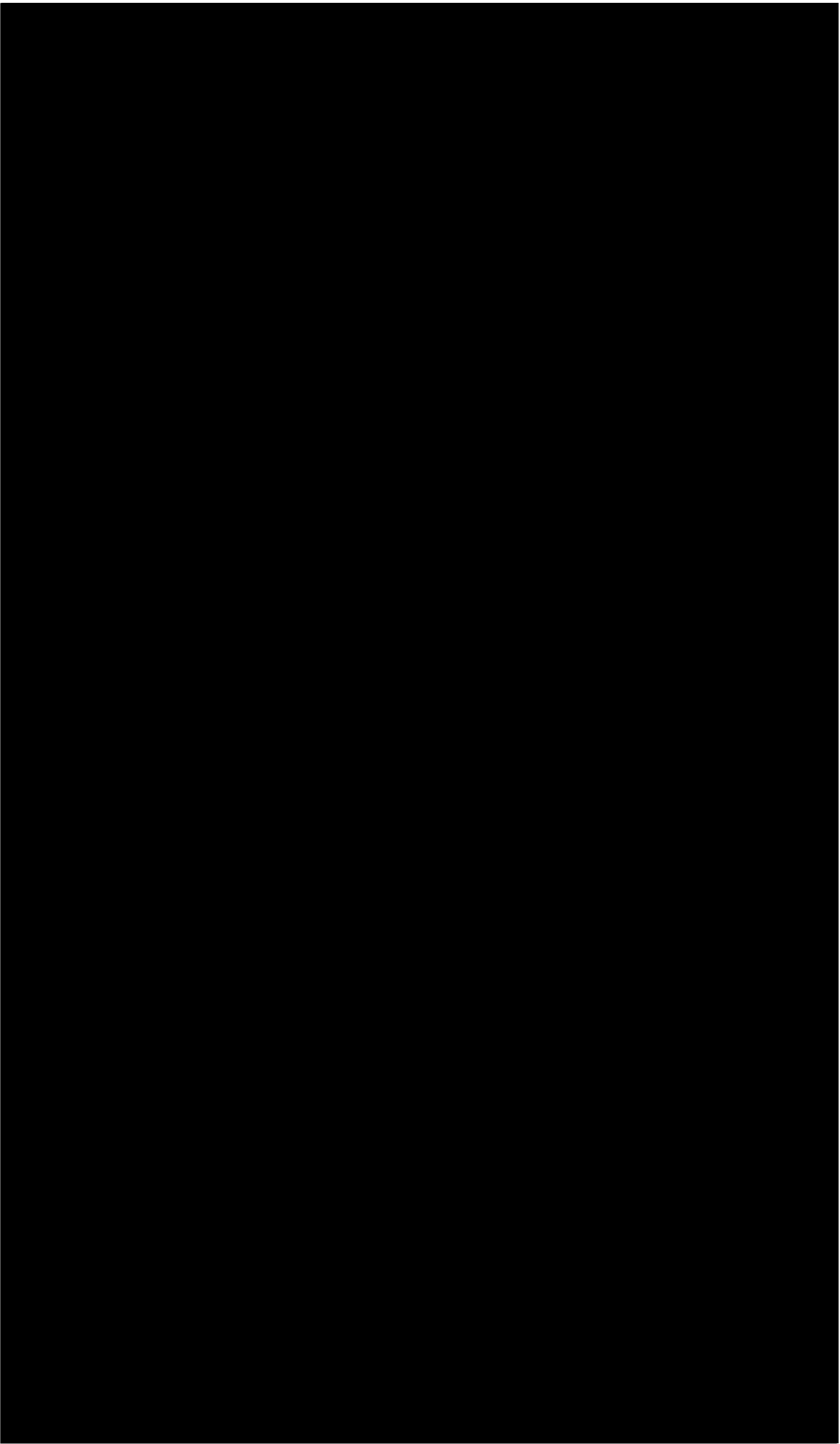

## 8. PLC (Aries)

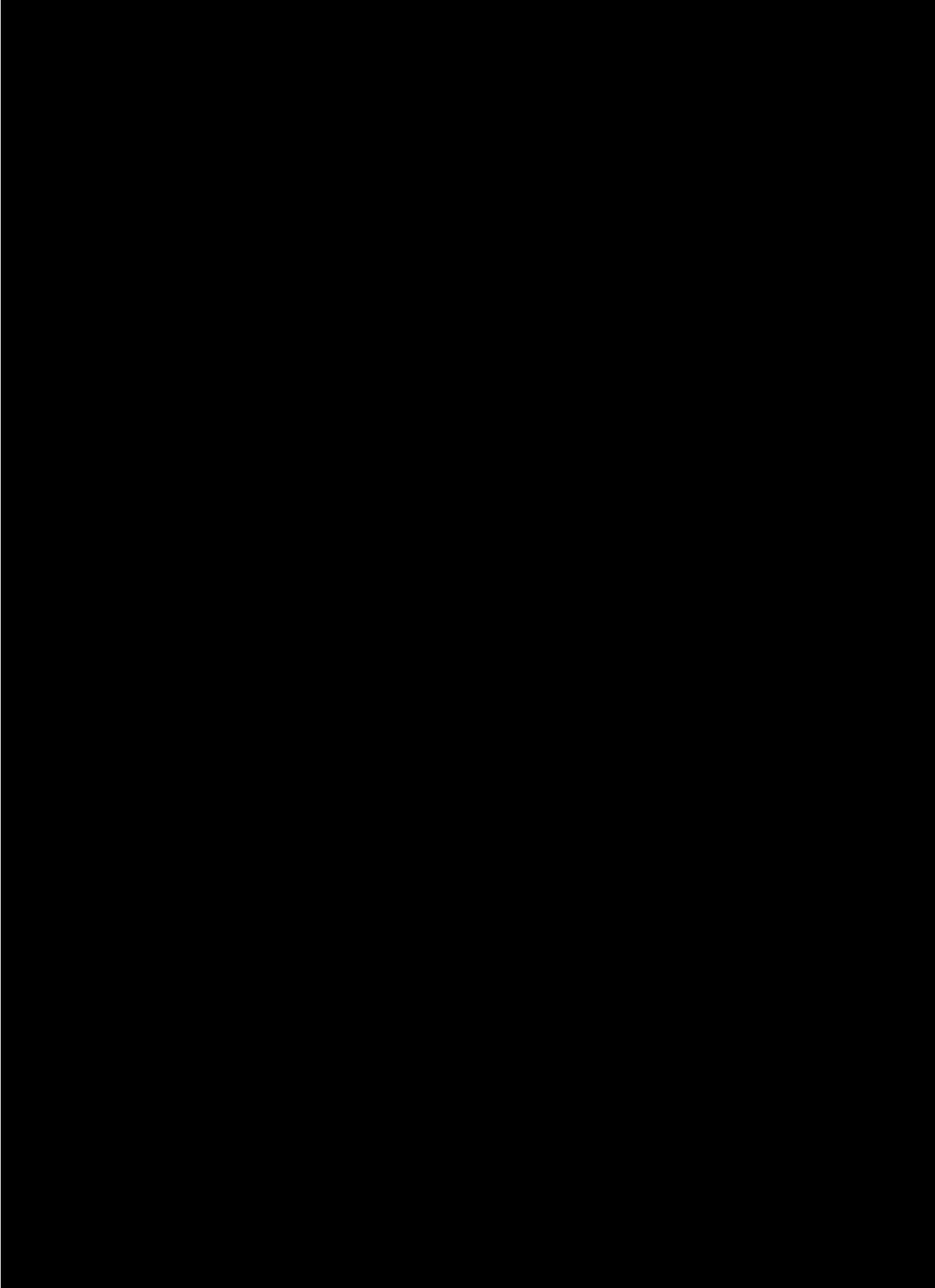

## 8. PLC (Aries-Q)

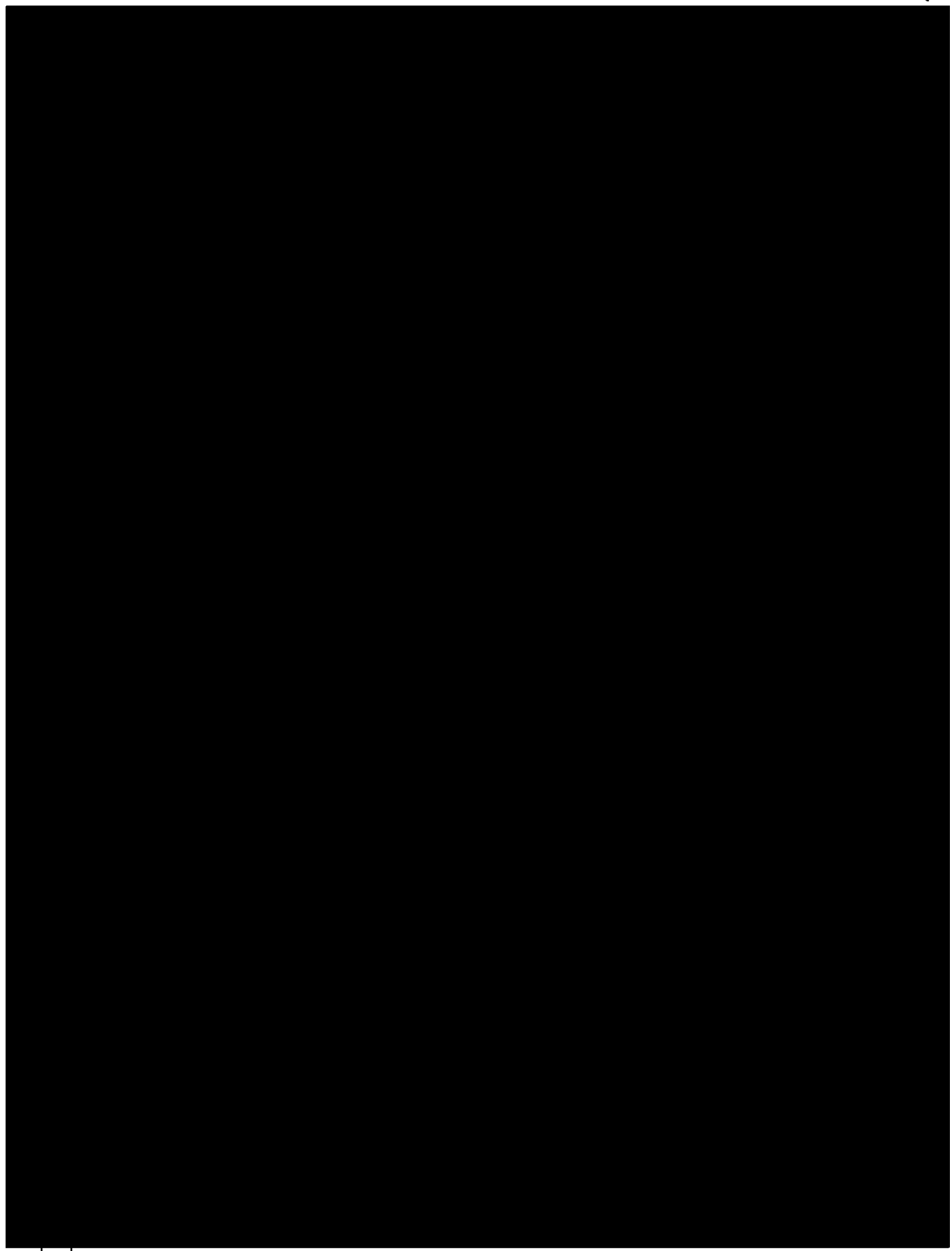

# 9. Schedule : 개발일정 - Aries

CONFIDENTIAL

		2010							
	2009	Dec	Jan	Feb	Mar	Apr	May	Jun	Jul
Design			디자인 확정 W2 (1/15) ↑ 실장검토 W4 (1/29) ↑						
Product Planning			↑ DIA완료 W5 (2/3) ↑						
Standard Approval									
DV		DV			↑ DVR W12 (3/24) ↑				
PV					PV ↑ FVR W16 (4/21) ↑				
PR						↑ PRA W18 (5/6) ↑			
TA									
Shipment							○ 내부목표 SRA W20 (5/20) ○	○ 공식 SRA W26 (7/2) ○	
Sample			MWC W/S 10EA W5 (2/5) ○	Pre-MKT 500EA W7 (2/19) ○					

# 9. Schedule : 개발일정 - Aries-Q

		2010								
2009		Dec	Jan	Feb	Mar	Apr	May	Jun	Jul	Aug
Design			디자인 확정 W2 (1/15) 실장검토 W3 (1/22)							
Product Planning			DIA 완료 W5 (2/3)							
DV			DV			DVR W16 (4/23)				
PV						PV	PVR W20 (5/20)			
PR							PRA W22 (6/4)			
TA										
Shipment								내부목표 SRA W24 (6/18)		공식 SRA W31 (8/2)
Sample					Pre-MKT 300EA W12 (3/26)					

# 9. Schedule : Global Launch Plan

## Aries 지역별 개발 일정 (내부목표 SRA 5/20 기준)

		2010											
		3월	4월	5월	6월	7월	8월	9월	10월	11월	12월		
구분	Dimension (Thickness: mm)												
G. GSM (open)	9.9T	DIA 2/3 ↑		SRA 5/20 ↑									
GPG 4대 사업자					SRA 6/25 ↑								
미주 GSM TMO		DIA 2/8				SRA 7/14 ↑							
국판		DIA 2/3 SRA 3/30 ↑											
중국CMCC	10.8T	DIA 2/17			SRA 7/14 ↑								
중남미		DIA 2/3		SRA 5/20 ↑									
일본		DIA 2/24								SRA 11/30 ↑			

# Schedule - Service

CONFIDENTIAL

PVR

PRA

SRA

<p><b>Widget</b></p>	<ul style="list-style-type: none"> <li>• Check contract with CPs</li> <li>• Check embedding widget list</li> <li>• Check regional coverage of each widget</li> <li>• Complete widget development</li> <li>• Complete unit test</li> </ul>	<ul style="list-style-type: none"> <li>• Complete unit test</li> <li>• Check local language translation</li> <li>• Interoperability test among device, Widget server, and each CP server</li> </ul>	
<p><b>SNS</b></p>	<ul style="list-style-type: none"> <li>• Check development status of widget and application</li> <li>• Check contract with each SNS SPs</li> <li>• Check supporting SNS list</li> </ul>	<ul style="list-style-type: none"> <li>• Interoperability test among device, Samsung server, and each SNS server</li> </ul>	
<p><b>Integrated Phonebook</b></p>	<ul style="list-style-type: none"> <li>• Check contract with each ISPs</li> <li>• Check supporting ISP list</li> <li>• Check development status of following S/W SEVEN Engine IM Client Email Client Service Integration</li> </ul>	<ul style="list-style-type: none"> <li>• Interoperability test among device, Samsung server, and each ISP server</li> </ul>	
<p><b>kies</b></p>	<ul style="list-style-type: none"> <li>• Check PC Application development status</li> <li>• Complete unit test</li> </ul>	<ul style="list-style-type: none"> <li>• Check connectivity test between PC and device</li> </ul>	

# Aries(S1) (I9000)

Smartphone for Smart Life

Infotainment  
Rich Media

Operator's  
Category

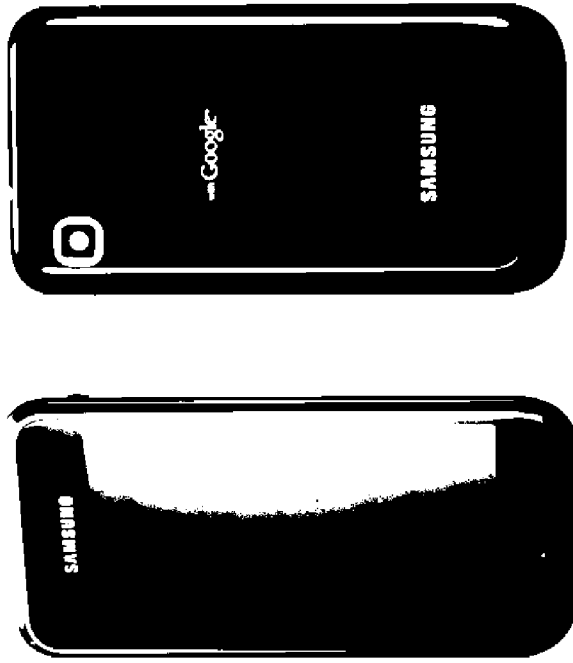

Bearer	Cam.	LCD	OS	Type
HSUPA	5M	4.0"	Android (Éclair)	Touch

Availability May 2010

T/P € 380

## Key Features (USP):

1. Large(4.0") & Thin(9.9t) Stylish Design
  - Slimmest w/ 1500mAh Battery
2. Ultra Vivid Display with On-Cell AMOLED
  - Best Readability & Low Power Consumption
3. Social Hub: Unified Social Life
  - Integrated Phonebook w/ SNS, IM, E-mail
  - Life Manager : Unified Calendar
4. Widget Almighty
  - Multiple Information In a Widget
  - . Hybrid Clock, Buddies Now etc

## Predecessor

GT-I7500 (5MP, Android)



Main Color

TBD

Freq. Band

3G 900/1900/2100

2G 850/900/1800/1900



<b>19000</b>	<b>GPP Aries(S1)</b>
Galaxy(I7500)'s Successor	Smartphone for Smart Life
<b>Jan. 31<sup>th</sup> 2010</b>	
<b>Target Category</b>	- Infotainment
<b>Target Segment</b>	- Rich Media
<b>Main competitors</b>	- iPhone 3G S - NexusOne - Moto Droid - SEMC X10 - HTC Bravo
<b>Inbox VPS</b>	- Data Cable - TA - Headset
<b>Optional VPS</b>	- Basic Cradle - Stereo Speaker - Project Module - Car Navi-kit - BT Headset - C-type Stylus Pen

<b>Main Features</b>	
Operating System	Android OS Éclair 2.1
Chipset	BB: IFX6160 / AP: S5P C110
Camera	5MP AF w/o LED flash
Display Resolution/Size	4.0" WVGA On-Cell AMOLED
3G Bearer &Band	HSUPA 5.76 Mbps 900/1900/2100
2G Bearer &Band	EDGE/GPRS 850/900/1800/1900
Connectivity	BT 2.1, USB 2.0, WiFi(b/g/n), MicroUSB
GPS	A-GPS
Radio	FM Radio with RDS
Audio	MP3, AAC, AAC+, eAAC+, WMA, RA
Video	MPEG4, H.263, H.264, WMV, RV, DivX, Xvid
Memory	4Gb+3Gb+1Gb/16GB MovINAND, MicroSD (upto 32GB)
Additional Applications	TouchWiz 3.0 for Android, Multistage, Augmented Reality, Integrated phonebook with SNS, IM &E-mail
Talk/Standby time	1500 mAh
SPK	11x15
<b>CMF</b>	-
<b>SRA</b>	'10.05
M/C, 판가	<b>\$205, €380(16GB)</b>
출시지역	<b>Global</b>

<b>Form Factor &amp; Design</b>	 <table border="1"> <tr> <td>Slider</td> <td>Folder</td> <td>Bar</td> <td>Touch</td> <td>Qwerty</td> </tr> <tr> <td></td> <td></td> <td>○</td> <td>○</td> <td>○</td> </tr> </table>	Slider	Folder	Bar	Touch	Qwerty			○	○	○
Slider	Folder	Bar	Touch	Qwerty							
		○	○	○							
<b>Dimensions &amp; Weight</b>	- 64.2 x 122.4 x 9.9 mm, TBD g										
<b>USPs</b>	<ol style="list-style-type: none"> <li>Large(4.0") &amp; Thin(9.9t) Stylish Design <ul style="list-style-type: none"> <li>- Slimmest w/ 1500mAh Battery</li> </ul> </li> <li>Ultra Vivid Display with OOAMOLED <ul style="list-style-type: none"> <li>- Best Readability &amp; Low Power Consumption</li> </ul> </li> <li>Social Hub: Unified Social Life <ul style="list-style-type: none"> <li>- Integrated Phonebook w/ SNS, IM etc</li> <li>- Life Manager : Unified Calendar</li> </ul> </li> <li>Widget Almighty <ul style="list-style-type: none"> <li>- Multiple Information In a Widget</li> <li>- Hybrid Clock, Buddies Now etc</li> </ul> </li> </ol>										

# Aries-Q (S1-Q) (I9050)

Innovative Social Bridge – Easier to Cross

Infotainment  
Rich Media

Operator's  
Category

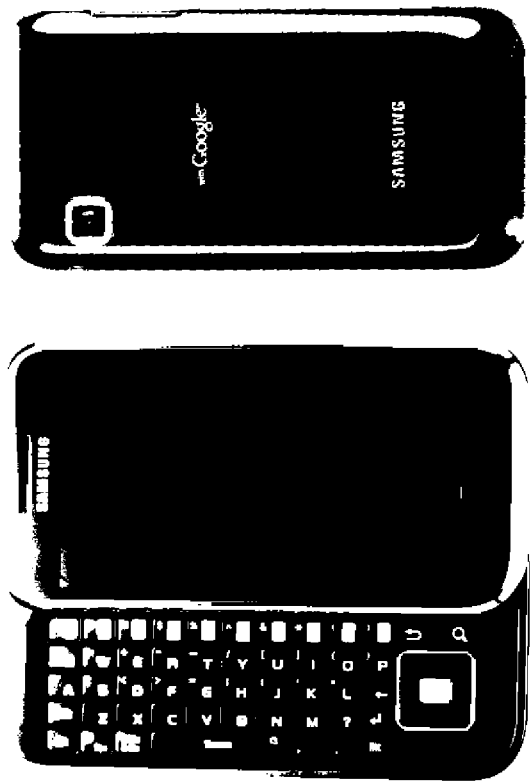

Bearer	Cam.	LCD	OS	Type
HSUPA	5M	4.0" WVGA	Android (Éclair)	Touch+ QWERTY

Availability Jun. 2010

T/P € 400

## Key Features (USP):

1. Best Input Interface for Mobile Web
  - Optimal input interface for GMS, IM & Write & Go
2. Ultra Vivid and Clear Display with AMOLED +
  - Best readability & Low power consumption
3. Unified Social Life
  - Integrated Phonebook w/ SNS, IM, E-mail
  - Real-time Update : Push Services
  - Life Manager : Unified Calendar
4. Widget Almighty
  - Multiple Information In a Widget
  - . Hybrid Clock, Living Buddies, Days etc

Predecessor

GT-I9000 (5MP, Android)



Main Color

TBD

Freq. Band

3G 900/1900/2100

2G 850/900/1800/1900

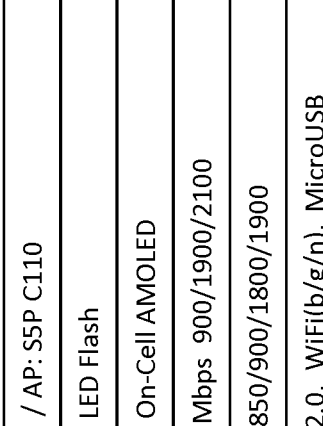
<b>GT-I9050</b>	<b>GPP Aries-Q (S1-Q)</b>	<b>Feb. 3rd 2010</b>																														
Aries(19000)'s Successor	Innovative Social Bridge – Easier to Cross	Target Category																														
<b>Form Factor &amp; Design</b> 		Target Segment																														
		- Infotainment																														
<b>Main Features</b> <table border="1"> <tr> <td>Operating System</td> <td>Android OS Éclair 2.1</td> </tr> <tr> <td>Chipset</td> <td>BB: IFX6160 / AP: S5P C110</td> </tr> <tr> <td>Camera</td> <td>5MP AF w/o LED Flash</td> </tr> <tr> <td>Display Resolution/Size</td> <td>4.0" WVGA On-Cell AMOLED</td> </tr> <tr> <td>3G Bearer &amp;Band</td> <td>HSUPA 5.76 Mbps 900/1900/2100</td> </tr> <tr> <td>2G Bearer &amp;Band</td> <td>EDGE/GPRS 850/900/1800/1900</td> </tr> <tr> <td>Connectivity</td> <td>BT 2.1, USB 2.0, WiFi(b/g/n), MicroUSB</td> </tr> <tr> <td>GPS</td> <td>A-GPS</td> </tr> <tr> <td>Radio</td> <td>FM Radio with RDS</td> </tr> <tr> <td>Audio</td> <td>MP3, AAC, AAC+, eAAC+, WMA, RA</td> </tr> <tr> <td>Video</td> <td>MPEG4, H.263, H.264, WMV, RV, DivX, Xvid</td> </tr> <tr> <td>Memory</td> <td>4Gb+3Gb+1Gb+16GB moviNAND, MicroSD (up to 32GB)</td> </tr> <tr> <td>Additional Applications</td> <td>TouchWiz 3.0 for Android, Multistage, Augmented Reality, Integrated phonebook with SNS, IM, E-mail, etc.</td> </tr> <tr> <td>Talk/Standby time</td> <td>1500 mAh</td> </tr> <tr> <td>SPK</td> <td>11x15</td> </tr> </table>		Operating System	Android OS Éclair 2.1	Chipset	BB: IFX6160 / AP: S5P C110	Camera	5MP AF w/o LED Flash	Display Resolution/Size	4.0" WVGA On-Cell AMOLED	3G Bearer &Band	HSUPA 5.76 Mbps 900/1900/2100	2G Bearer &Band	EDGE/GPRS 850/900/1800/1900	Connectivity	BT 2.1, USB 2.0, WiFi(b/g/n), MicroUSB	GPS	A-GPS	Radio	FM Radio with RDS	Audio	MP3, AAC, AAC+, eAAC+, WMA, RA	Video	MPEG4, H.263, H.264, WMV, RV, DivX, Xvid	Memory	4Gb+3Gb+1Gb+16GB moviNAND, MicroSD (up to 32GB)	Additional Applications	TouchWiz 3.0 for Android, Multistage, Augmented Reality, Integrated phonebook with SNS, IM, E-mail, etc.	Talk/Standby time	1500 mAh	SPK	11x15	Main competitors
		Operating System	Android OS Éclair 2.1																													
Chipset	BB: IFX6160 / AP: S5P C110																															
Camera	5MP AF w/o LED Flash																															
Display Resolution/Size	4.0" WVGA On-Cell AMOLED																															
3G Bearer &Band	HSUPA 5.76 Mbps 900/1900/2100																															
2G Bearer &Band	EDGE/GPRS 850/900/1800/1900																															
Connectivity	BT 2.1, USB 2.0, WiFi(b/g/n), MicroUSB																															
GPS	A-GPS																															
Radio	FM Radio with RDS																															
Audio	MP3, AAC, AAC+, eAAC+, WMA, RA																															
Video	MPEG4, H.263, H.264, WMV, RV, DivX, Xvid																															
Memory	4Gb+3Gb+1Gb+16GB moviNAND, MicroSD (up to 32GB)																															
Additional Applications	TouchWiz 3.0 for Android, Multistage, Augmented Reality, Integrated phonebook with SNS, IM, E-mail, etc.																															
Talk/Standby time	1500 mAh																															
SPK	11x15																															
<b>USPs</b> <ul style="list-style-type: none"> <li>- Best Input Interface for Mobile Web</li> <li>- Unified Social Life</li> <li>- Integrated PB with SNS, IM, E-mail</li> <li>- Real-time Update : Push Services</li> <li>- Life Manager : Unified Calendar</li> <li>- Widget Almighty</li> <li>- Unified Multiple Widgets</li> <li>- Focus &amp; Find</li> <li>- Augmented Reality Social Browser</li> <li>- Powerful Multimedia</li> </ul>		Inbox VPS																														
		- Data Cable - TA - Headset																														
<b>Dimensions &amp; Weight</b> - 126 x 64.2 x 13.5 mm, TBD g		Optional VPS																														
		- Basic Cradle - Stereo Speaker - Project Module - Car Navi-kit - BT Headset																														

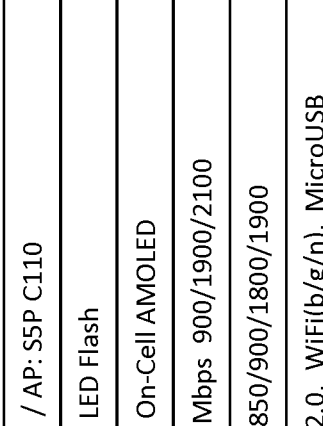
<b>GT-I9050</b>	<b>GPP Aries-Q (S1-Q)</b>	<b>Feb. 3rd 2010</b>																														
Aries(19000)'s Successor	Innovative Social Bridge – Easier to Cross	Target Category																														
<b>Form Factor &amp; Design</b> 		Target Segment																														
		- Infotainment																														
<b>Main Features</b> <table border="1"> <tr> <td>Operating System</td> <td>Android OS Éclair 2.1</td> </tr> <tr> <td>Chipset</td> <td>BB: IFX6160 / AP: S5P C110</td> </tr> <tr> <td>Camera</td> <td>5MP AF w/o LED Flash</td> </tr> <tr> <td>Display Resolution/Size</td> <td>4.0" WVGA On-Cell AMOLED</td> </tr> <tr> <td>3G Bearer &amp;Band</td> <td>HSUPA 5.76 Mbps 900/1900/2100</td> </tr> <tr> <td>2G Bearer &amp;Band</td> <td>EDGE/GPRS 850/900/1800/1900</td> </tr> <tr> <td>Connectivity</td> <td>BT 2.1, USB 2.0, WiFi(b/g/n), MicroUSB</td> </tr> <tr> <td>GPS</td> <td>A-GPS</td> </tr> <tr> <td>Radio</td> <td>FM Radio with RDS</td> </tr> <tr> <td>Audio</td> <td>MP3, AAC, AAC+, eAAC+, WMA, RA</td> </tr> <tr> <td>Video</td> <td>MPEG4, H.263, H.264, WMV, RV, DivX, Xvid</td> </tr> <tr> <td>Memory</td> <td>4Gb+3Gb+1Gb+16GB moviNAND, MicroSD (up to 32GB)</td> </tr> <tr> <td>Additional Applications</td> <td>TouchWiz 3.0 for Android, Multistage, Augmented Reality, Integrated phonebook with SNS, IM, E-mail, etc.</td> </tr> <tr> <td>Talk/Standby time</td> <td>1500 mAh</td> </tr> <tr> <td>SPK</td> <td>11x15</td> </tr> </table>		Operating System	Android OS Éclair 2.1	Chipset	BB: IFX6160 / AP: S5P C110	Camera	5MP AF w/o LED Flash	Display Resolution/Size	4.0" WVGA On-Cell AMOLED	3G Bearer &Band	HSUPA 5.76 Mbps 900/1900/2100	2G Bearer &Band	EDGE/GPRS 850/900/1800/1900	Connectivity	BT 2.1, USB 2.0, WiFi(b/g/n), MicroUSB	GPS	A-GPS	Radio	FM Radio with RDS	Audio	MP3, AAC, AAC+, eAAC+, WMA, RA	Video	MPEG4, H.263, H.264, WMV, RV, DivX, Xvid	Memory	4Gb+3Gb+1Gb+16GB moviNAND, MicroSD (up to 32GB)	Additional Applications	TouchWiz 3.0 for Android, Multistage, Augmented Reality, Integrated phonebook with SNS, IM, E-mail, etc.	Talk/Standby time	1500 mAh	SPK	11x15	Main competitors
		Operating System	Android OS Éclair 2.1																													
Chipset	BB: IFX6160 / AP: S5P C110																															
Camera	5MP AF w/o LED Flash																															
Display Resolution/Size	4.0" WVGA On-Cell AMOLED																															
3G Bearer &Band	HSUPA 5.76 Mbps 900/1900/2100																															
2G Bearer &Band	EDGE/GPRS 850/900/1800/1900																															
Connectivity	BT 2.1, USB 2.0, WiFi(b/g/n), MicroUSB																															
GPS	A-GPS																															
Radio	FM Radio with RDS																															
Audio	MP3, AAC, AAC+, eAAC+, WMA, RA																															
Video	MPEG4, H.263, H.264, WMV, RV, DivX, Xvid																															
Memory	4Gb+3Gb+1Gb+16GB moviNAND, MicroSD (up to 32GB)																															
Additional Applications	TouchWiz 3.0 for Android, Multistage, Augmented Reality, Integrated phonebook with SNS, IM, E-mail, etc.																															
Talk/Standby time	1500 mAh																															
SPK	11x15																															
<b>USPs</b> <ul style="list-style-type: none"> <li>- Best Input Interface for Mobile Web</li> <li>- Unified Social Life</li> <li>- Integrated PB with SNS, IM, E-mail</li> <li>- Real-time Update : Push Services</li> <li>- Life Manager : Unified Calendar</li> <li>- Widget Almighty</li> <li>- Unified Multiple Widgets</li> <li>- Focus &amp; Find</li> <li>- Augmented Reality Social Browser</li> <li>- Powerful Multimedia</li> </ul>		Inbox VPS																														
		- Data Cable - TA - Headset																														
<b>Dimensions &amp; Weight</b> - 126 x 64.2 x 13.5 mm, TBD g		Optional VPS																														
		- Basic Cradle - Stereo Speaker - Project Module - Car Navi-kit - BT Headset																														

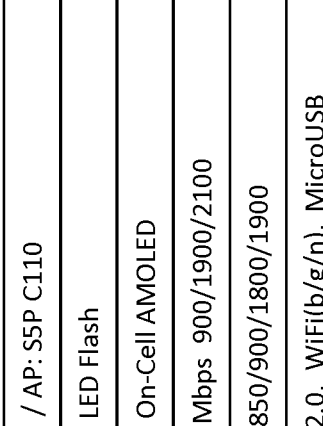
<b>GT-I9050</b>	<b>GPP Aries-Q (S1-Q)</b>	<b>Feb. 3rd 2010</b>																														
Aries(19000)'s Successor	Innovative Social Bridge – Easier to Cross	Target Category																														
<b>Form Factor &amp; Design</b> 		Target Segment																														
		- Infotainment																														
<b>Main Features</b> <table border="1"> <tr> <td>Operating System</td> <td>Android OS Éclair 2.1</td> </tr> <tr> <td>Chipset</td> <td>BB: IFX6160 / AP: S5P C110</td> </tr> <tr> <td>Camera</td> <td>5MP AF w/o LED Flash</td> </tr> <tr> <td>Display Resolution/Size</td> <td>4.0" WVGA On-Cell AMOLED</td> </tr> <tr> <td>3G Bearer &amp;Band</td> <td>HSUPA 5.76 Mbps 900/1900/2100</td> </tr> <tr> <td>2G Bearer &amp;Band</td> <td>EDGE/GPRS 850/900/1800/1900</td> </tr> <tr> <td>Connectivity</td> <td>BT 2.1, USB 2.0, WiFi(b/g/n), MicroUSB</td> </tr> <tr> <td>GPS</td> <td>A-GPS</td> </tr> <tr> <td>Radio</td> <td>FM Radio with RDS</td> </tr> <tr> <td>Audio</td> <td>MP3, AAC, AAC+, eAAC+, WMA, RA</td> </tr> <tr> <td>Video</td> <td>MPEG4, H.263, H.264, WMV, RV, DivX, Xvid</td> </tr> <tr> <td>Memory</td> <td>4Gb+3Gb+1Gb+16GB moviNAND, MicroSD (up to 32GB)</td> </tr> <tr> <td>Additional Applications</td> <td>TouchWiz 3.0 for Android, Multistage, Augmented Reality, Integrated phonebook with SNS, IM, E-mail, etc.</td> </tr> <tr> <td>Talk/Standby time</td> <td>1500 mAh</td> </tr> <tr> <td>SPK</td> <td>11x15</td> </tr> </table>		Operating System	Android OS Éclair 2.1	Chipset	BB: IFX6160 / AP: S5P C110	Camera	5MP AF w/o LED Flash	Display Resolution/Size	4.0" WVGA On-Cell AMOLED	3G Bearer &Band	HSUPA 5.76 Mbps 900/1900/2100	2G Bearer &Band	EDGE/GPRS 850/900/1800/1900	Connectivity	BT 2.1, USB 2.0, WiFi(b/g/n), MicroUSB	GPS	A-GPS	Radio	FM Radio with RDS	Audio	MP3, AAC, AAC+, eAAC+, WMA, RA	Video	MPEG4, H.263, H.264, WMV, RV, DivX, Xvid	Memory	4Gb+3Gb+1Gb+16GB moviNAND, MicroSD (up to 32GB)	Additional Applications	TouchWiz 3.0 for Android, Multistage, Augmented Reality, Integrated phonebook with SNS, IM, E-mail, etc.	Talk/Standby time	1500 mAh	SPK	11x15	Main competitors
		Operating System	Android OS Éclair 2.1																													
Chipset	BB: IFX6160 / AP: S5P C110																															
Camera	5MP AF w/o LED Flash																															
Display Resolution/Size	4.0" WVGA On-Cell AMOLED																															
3G Bearer &Band	HSUPA 5.76 Mbps 900/1900/2100																															
2G Bearer &Band	EDGE/GPRS 850/900/1800/1900																															
Connectivity	BT 2.1, USB 2.0, WiFi(b/g/n), MicroUSB																															
GPS	A-GPS																															
Radio	FM Radio with RDS																															
Audio	MP3, AAC, AAC+, eAAC+, WMA, RA																															
Video	MPEG4, H.263, H.264, WMV, RV, DivX, Xvid																															
Memory	4Gb+3Gb+1Gb+16GB moviNAND, MicroSD (up to 32GB)																															
Additional Applications	TouchWiz 3.0 for Android, Multistage, Augmented Reality, Integrated phonebook with SNS, IM, E-mail, etc.																															
Talk/Standby time	1500 mAh																															
SPK	11x15																															
<b>USPs</b> <ul style="list-style-type: none"> <li>- Best Input Interface for Mobile Web</li> <li>- Unified Social Life</li> <li>- Integrated PB with SNS, IM, E-mail</li> <li>- Real-time Update : Push Services</li> <li>- Life Manager : Unified Calendar</li> <li>- Widget Almighty</li> <li>- Unified Multiple Widgets</li> <li>- Focus &amp; Find</li> <li>- Augmented Reality Social Browser</li> <li>- Powerful Multimedia</li> </ul>		Inbox VPS																														
		- Data Cable - TA - Headset																														
<b>Dimensions &amp; Weight</b> - 126 x 64.2 x 13.5 mm, TBD g		Optional VPS																														
		- Basic Cradle - Stereo Speaker - Project Module - Car Navi-kit - BT Headset																														

# Appendix

# Competitiveness Review

## [iPhone 대비 강점]

- Multi-tasking 가능  
(Aries는 6개까지 보임, memory 허용하는 만큼 가능)
- 다양한 동영상 포맷 지원  
(iPhone의 경우 mp4만 지원)
- 사업자 customization 가능
- Universal search (Local+Web search)
- FOTA upgrade 가능  
(iPhone의 경우 iTunes 유선 연결 후 재택 다운로드)
- Adobe Flash 9 지원



## [타사 Android 대비 강점]

- Samsung Android UX 적용
- HW spec 우수  
(Super AMOLED, 1GHz Chipset, VT Call 지원 등)
- Android Market 외에도 More Widget, Slideme 등 추가적인 Marketplace 제공
- Application 및 Contents를 저장할 수 있는 충분한 User Memory 제공 (16GB default)
- Multi-touch Pinch zoom in/out 적용
- 기기간 Convergence : 3 Screen (DLNA)

## [공통 강점]

- Swype Integration으로 빠른 typing 가능
- Social Hub(Integrated Phonebook) 지원
- Hybrid Widgets
- Context Awareness UX 적용

# Android Platform Roadmap

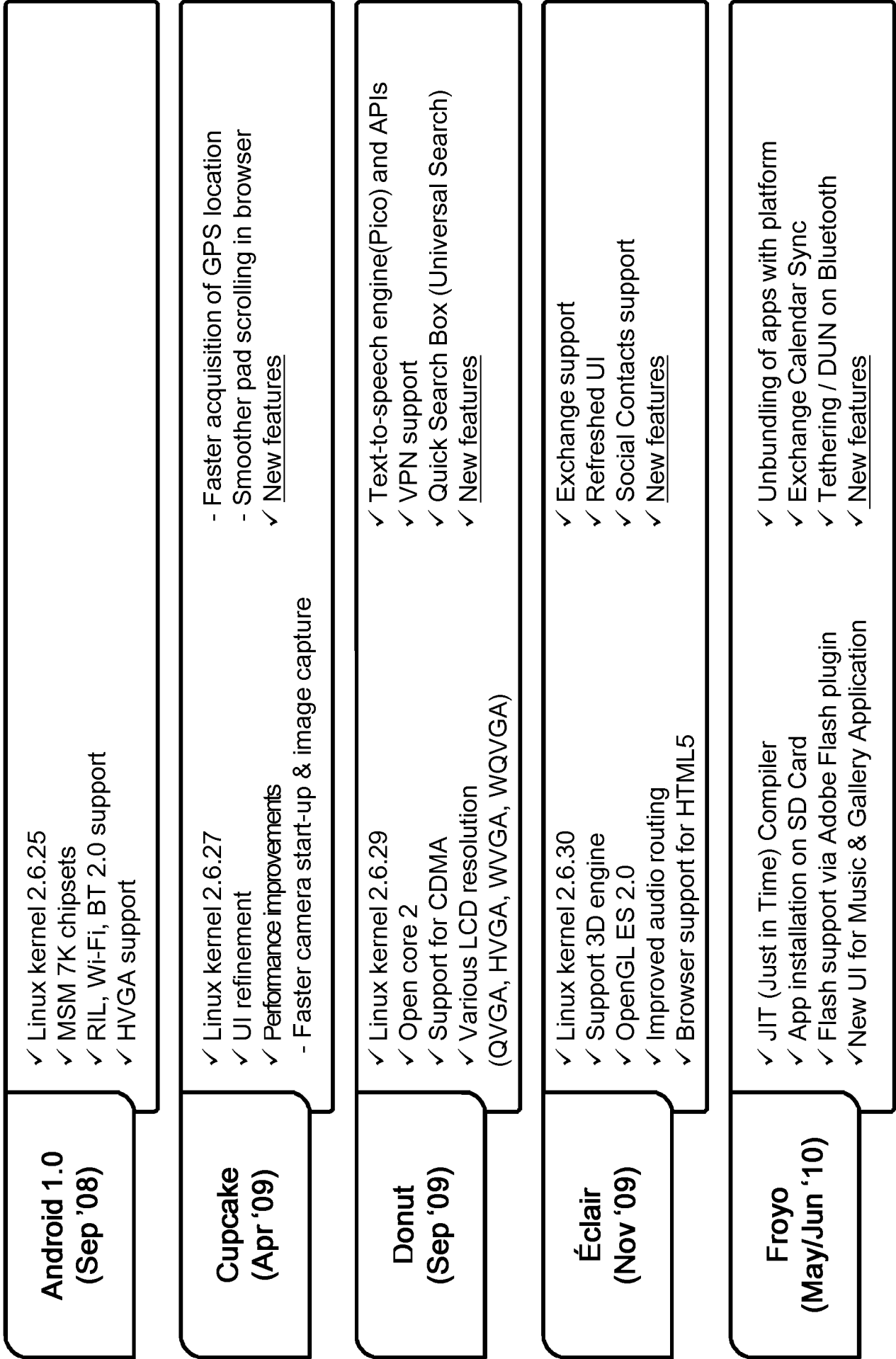

# Android 1.5 – New Feature

## Android 1.5 (Cupcake)

### User interface refinements:

#### System-wide:

- Refinement of all core UI elements
- Animated window transitions (off by default)
- Accelerometer-based application rotations

### Performance improvements:

- Faster Camera start-up and image capture
- Much faster acquisition of GPS location (powered by SUPL AGPS)
- Smoother page scrolling in Browser

### Applications

- Camera & Gallery ; Video recording / Video playback (MPEG-4 & 3GP formats)
- Browser ; Updated with latest Webkit browser & Squirrelfish Javascript engines, Copy 'n paste in browser,, etc.
- Contacts ; Shows user picture for Favorites, Specific date/time stamp for events in call log, etc.

### Application framework

- On-screen soft keyboard ; Works in both portrait and landscape orientation, User dictionary for custom words, etc.
- Home screen ; Widgets, Live folders
- UI framework ; Framework for easier background/UI thread interaction, New SlidingDrawer widget, etc.
- Home Screen framework ; APIs for creating secure home screen widgets, etc.
- Media framework ; Raw audio recording and playback APIs, Interactive MIDI playback engine, Media search Intent, etc.
- Input Method framework ; Text prediction engine, Ability to provide downloadable IMEs to users
- Speech recognition framework ; Support for using speech recognition libraries via Intent
- Misc API additions



for more, visit [HERE](#)

# Android 1.6 – New Feature

## Android 1.6 (Donut)

### User interface refinements:

- Quick Search Box: search across multiple sources from home screen (browser bookmarks, history, contacts, and the web)
- Battery usage indicator: lets users see which apps and services are consuming battery power
- Camera: Integrated camera, camcorder, and gallery experience, enable user to select multiple photos

### Performance improvements:

- Faster Camera experience: launching the camera, completing one shot to the next

### Android Market Updates

- At the homescreen, users can choose among Apps, Games, and Downloads.
- Inside a category, users can explore titles that are Top paid, Top free, and Just in.
- For each title, users can now see screenshots submitted by developers in addition to reviews from other users

### Application framework

- VPN, 802.1x: VPN control panel in Settings
- Text-to-speech engine(Pico): allows any Android application to "speak" a string of text with an accent (supports the following languages: English (American and British accents), French, Italian, German and Spanish)
- Gestures: creating, storing, loading, and recognizing gestures and associating them with specific actions (GestureBuilder tool included in the Android 1.6 SDK)
- Accessibility: accessibility plugins that respond to user input, such as making a sound when a new window is shown, vibrating when navigating to the top of a list, and providing spoken feedback



for more, visit [HERE](#)



# Android 2.0 – New Feature

## Android 2.0 (Éclair)

### User interface refinements

- Contacts & accounts: Sync support for contact sync from multiple data sources including Exchange. Handset manufacturers will need EAS license for distribution.
- Mail: Exchange support. Handset manufacturers will need EAS license for distribution. Merged folders across multiple accounts for inbox, unread, flagged
- Camera : Support for built-in flash
- Android keyboard : Improved layout and better responsiveness, Smarter dictionary
- Browser: Refreshed UI with actionable browser URL bar, Support for double-tap to zoom
- Calendar: Agenda view with infinite scrolling, Attendee status and guest invites
- Messaging: Ability to search SMS and MMS messages, Auto-delete old messages when short on storage

### New Platform Technologies

- Media framework: Completely revamped graphics architecture for improved performance enabling better hardware acceleration
- Bluetooth: New BT profiles(Object Push Profile (OPP), Phone Book Access Profile (PBAP), Bluetooth 2.1

### New Developer APIs

- Bluetooth: Turn on/off Bluetooth, device and service discovery, send/receive data
- Sync adapters: New APIs for contacts sync adapters to connect to any backend
- Account Manager API: Centralized account manager API to securely store and access auth tokens/passwords across one or more services
- Contacts APIs: New contacts APIs that allow for data from multiple accounts, Support for 3rd party sync adapters
- WebView: HTML5 support(Database API, Application cache, Geolocation API, <video> tag support in Fullscreen mode)
- Framework: Framework support for simultaneous touch events

# Android Froyo Features

## Android Froyo (구 Flan)

- Performance 향상 및 사용자 편의성 증대를 목적으로 OS 버전 upgrade
- OS 최적화(fit & polish)를 통해 Éclair 보다 feature 많지만 RAM/ROM requirement가 같거나 더 적음
- 2010년 5-6월에 발표 예정, 공식 Letter는 2월 둘째 주 안에 파트너사에 전달 예정임

### Performance 향상

- JIT(Just in Time Compiler) 탑재 - JAVA 어플리케이션의 performance 향상 (Éclair 에도 탑재되었으나 Froyo에서 최초로 기능 활성화)
- 기존에 사용되던 Opencore 대신 Stagefright을 탑재하여 OS를 더 가볍고 빠르게 만듦
- Kernel: 2.6.32 (Éclair: 2.6.30)

### 사용자 편의성 증대

- Application을 SD card에 저장 가능 (기존: internal memory에만 저장 가능)
- Adobe Flash 지원 : Android Market을 통해 Adobe Flash Browser plugin 다운로드 가능
- Unbundling of apps with platform
  - Google Mobile Services 및 system app의 Android Market을 통한 update 가능
- Music & Gallery App의 새로운 UI 및 부분적인 UI refresh

### 기타

- Exchange Support - Calendar Sync, Password Admin (Remote Wipe 기능 탑재)
- USB 및 BT(DUN)를 이용한 Tethering 기능
- Game 개발자 지원을 위해 reference 용 sample code 발행 예정

# Apple App Store vs. Google Android Market

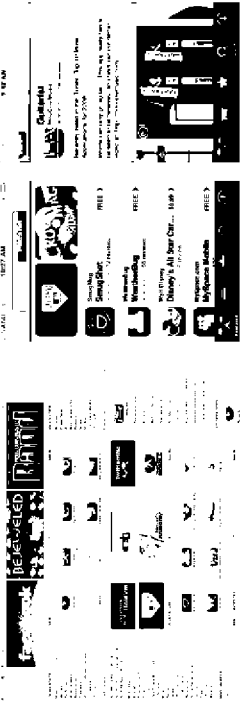
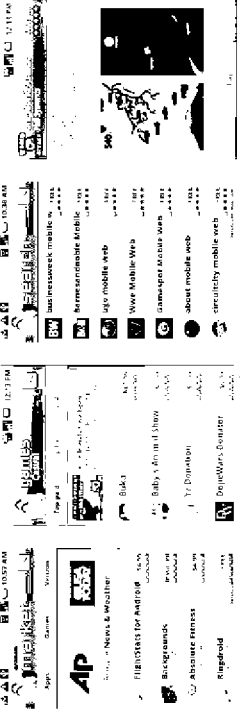
Apple App Store	Image	Google Android Market
		
77개국	Coverage	26개국
Developer 70%, Apple 30%	R/S Model	Developer 70%, Operator 30%
133,979개	어플 개수	23,475개
Game, Apps (20 Categories)	Categories	Games, Apps (18 Categories)
On-Device Client (무선) iTunes (유선)	Store Channel	On-Device Client (무선)
Credit Card, iTunes Gift Card	Payment	Credit Card, Operator Billing
<ul style="list-style-type: none"> <li>· 많은 국가 진출로 다양한 Local Apps 우위</li> <li>· 가입비 \$99(개인), \$299(기업)</li> </ul>	기타	<ul style="list-style-type: none"> <li>· 수익원이 아닌 GSM의 일부 Appl 로만 사용하므로 상대적 확산 속도 열세</li> <li>· 가입비 \$25 (공통)</li> <li>· 30% 수익제공으로 사업자 친화적</li> </ul>
<ul style="list-style-type: none"> <li>· iPhone, iPad 와 함께 지속적으로 Apps 수 가속 확대 (2010년 말 30만개 예상)</li> </ul>	평가	<ul style="list-style-type: none"> <li>· 단말 확산 속도가 iPhone보다 느려 Apps 의 개수 상대적 열세이나 2010년 중순 Android Market Promotion 예정</li> </ul>

# Intuitive Touch UX (1)

## ● Easier & More Customizable UX, TouchWiz 3.0

### 1. Integrated Home Screen

- Widget 화면 내 4개 Menu Customizing 가능  
→ 통합 Home screen
- Widget/Menu Page 별 Title 설정 가능  
→ Easy of Managing

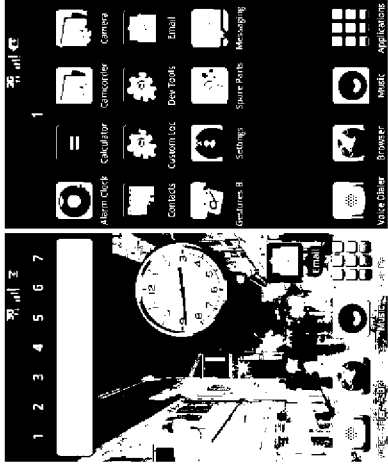

### 2. Maximizing Contents Area

- Video, Browser 등 화면에서 Simple한 Menu/Key 구성을 통해 화면 내 Contents 영역 최대화

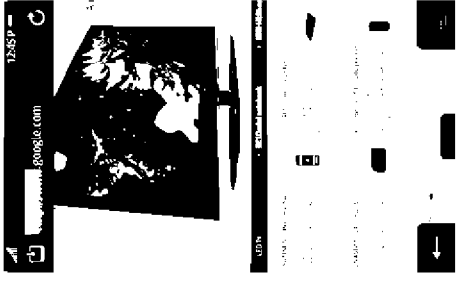

### 3. Efficient Multitasking, Quick Panel

- Quick Panel, Task Switcher 등으로 Multi-Tasking 환경 극대화

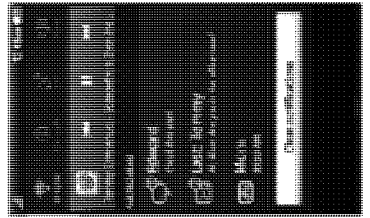

Quick Panel

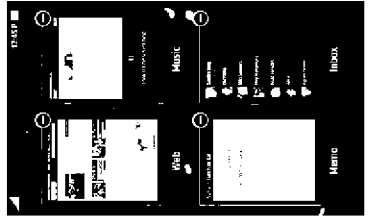

Task Switcher

### 4. Gesture Interaction

- Sweeping Up/Down Gesture를 통해 Quick Panel & More Option 창을 띄움으로써 불필요한 Interaction 제거 및 사용성 강화



# Intuitive Touch UX (2)

## ● Hybrid Widget

- 다양한 기능을 1가지 Widget에 구성함으로써 정보 접근성을 강화함

- ✓ Info alarm - 날씨, 주식, 최신 뉴스 정보 실시간 Update
- ✓ Hybrid clock - clock with various contents (finance, weather etc.)

- SNS 및 Contact Update 상황을 하나의 Widget으로 통합 관리 가능 (Live Buddy 外)

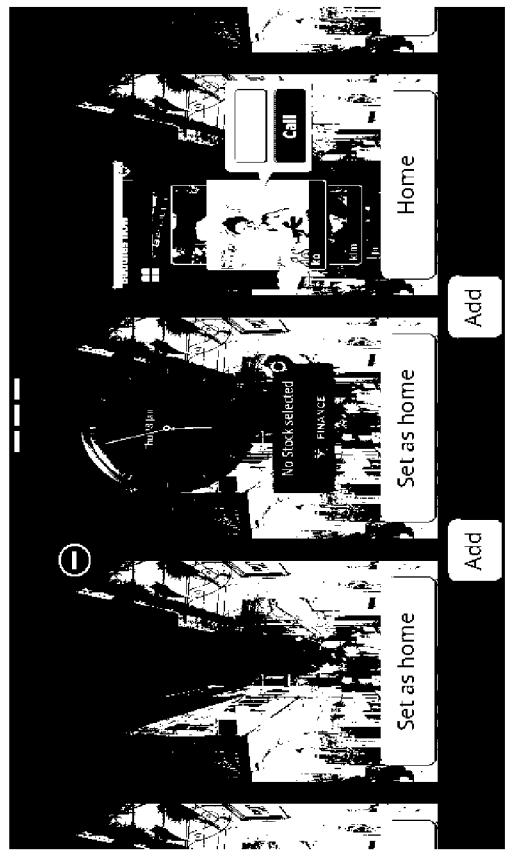
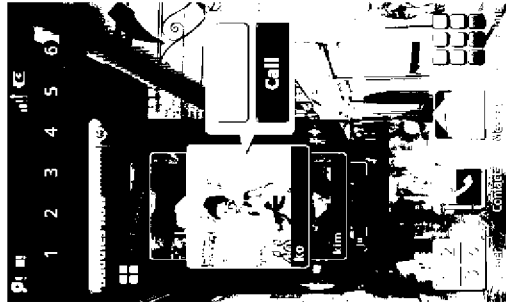
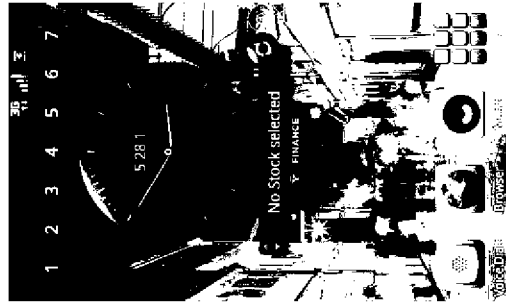
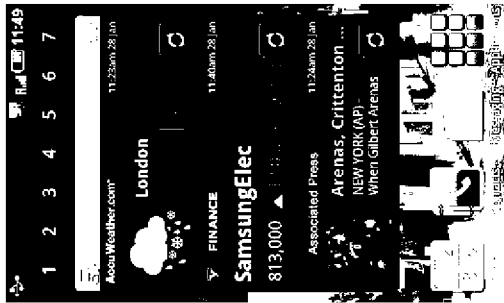

Advanced widgets

Menu/widget page edit

# Intuitive Touch UX (3)

## ● More Comfortable Input Mechanism

### - SWYPE

- ✓ 손가락 또는 Stylus로 Keyboard 위를 지나가면서 빠르게 단어 입력 가능
- ✓ SWIPE vs. iPhone 성능 비교 (25단어 입력時)  
: SWYPE 39초 vs. iPhone 71초 → 1.5배 빠름

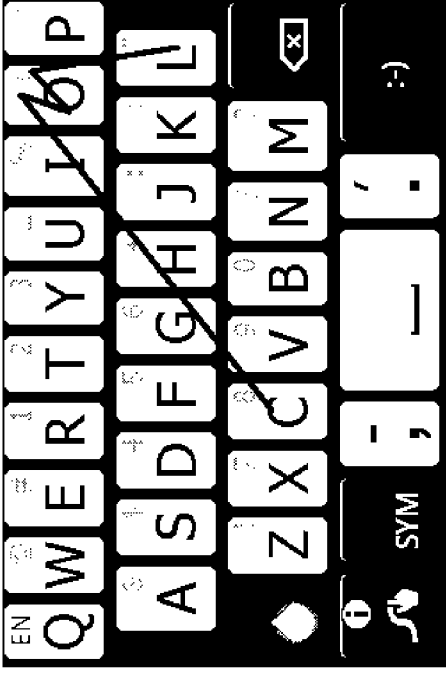

["cool" 단어 입력 예시]

### - XT9

- ✓ 사용자 사용 빈도수가 높은 단어를 미리 Prediction 해 제공 (on/off 설정 가능)
- ✓ 사용자가 원하는 단어를 추가 & 편집 가능

### - Voice Command

- ✓ 다양한 음성 인식 기능을 제공해 사용자 편의성 향상 (Voice Dialing/Playing/Recording)
- ✓ Text-to-Speech control을 통해 사용자에게 Notification 제공  
(Time & Date, Battery Level, Signal Strength, Memory Status 등)

→ Beyond Touch Experience 제공

# Unified Social Life (1)

- Real-time Push Service

- PIMS(Phonebook/Calendar), SNS, Messaging(IM, Email) Push 기반의

실시간 업데이트를 통해 Always-on Communication Channel 확립

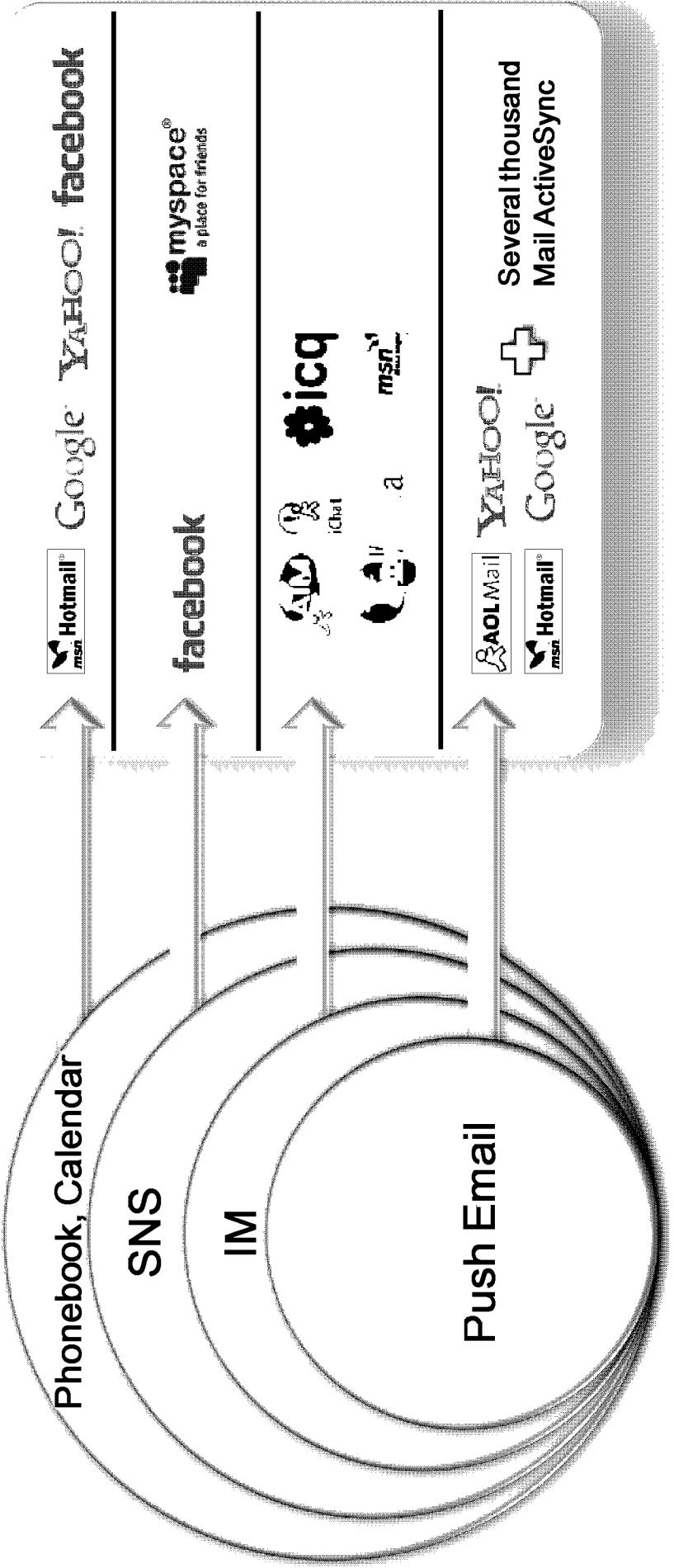

# Unified Social Life (2)

## ● Unified Phonebook

- 4개 Portal 및 주요 SNS Contact List와 연동해 Phone에서 통합 관리 가능
- Contact 정보에서 IM Login 확인 및 Chatting 가능

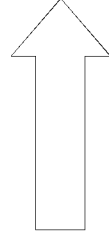

Contact List 통합

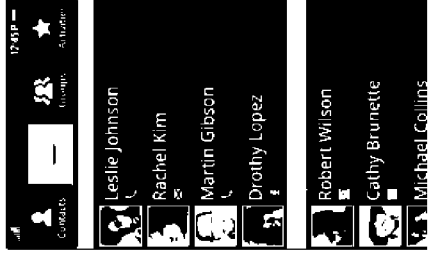

## ● Unified Calendar

- Outlook 및 Facebook 일정 정보와 연동해 Phone에서 통합 관리 가능
- 연동된 일정 정보가 어디에 등록되어 있던 것인지 구분해 표현

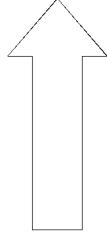
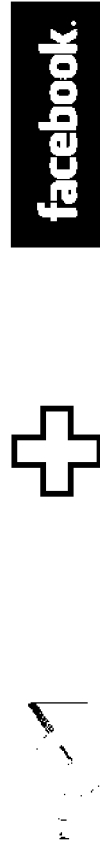

일정 정보 통합

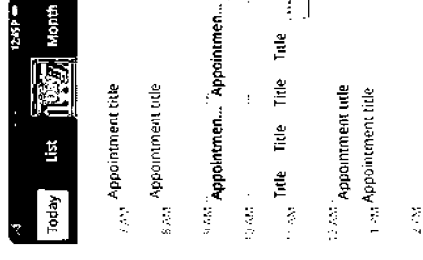

## ● Easy Email Set-up

- 약 1만 여개의 Email ISP 정보를 제공함으로써 Email Address 및 Password 입력 만으로도 Email 쉽게 설정 가능함





# More Intelligent Web Experience

- Google Chrome browser의 Customizing

- Android Éclair 버전에서 제공하는 Chrome Browser에 Value-added Feature 추가
  - ✓ Flash Lite 3.1 지원 : 주요 Portal 內 Flash 영상을 깨짐 없이 보여줌
  - ✓ Download 기능 강화 : OMA Download 지원 → DRM Contents Download 가능

→ 他 Android Phone 대비 PC-like한 Web Experience 제공

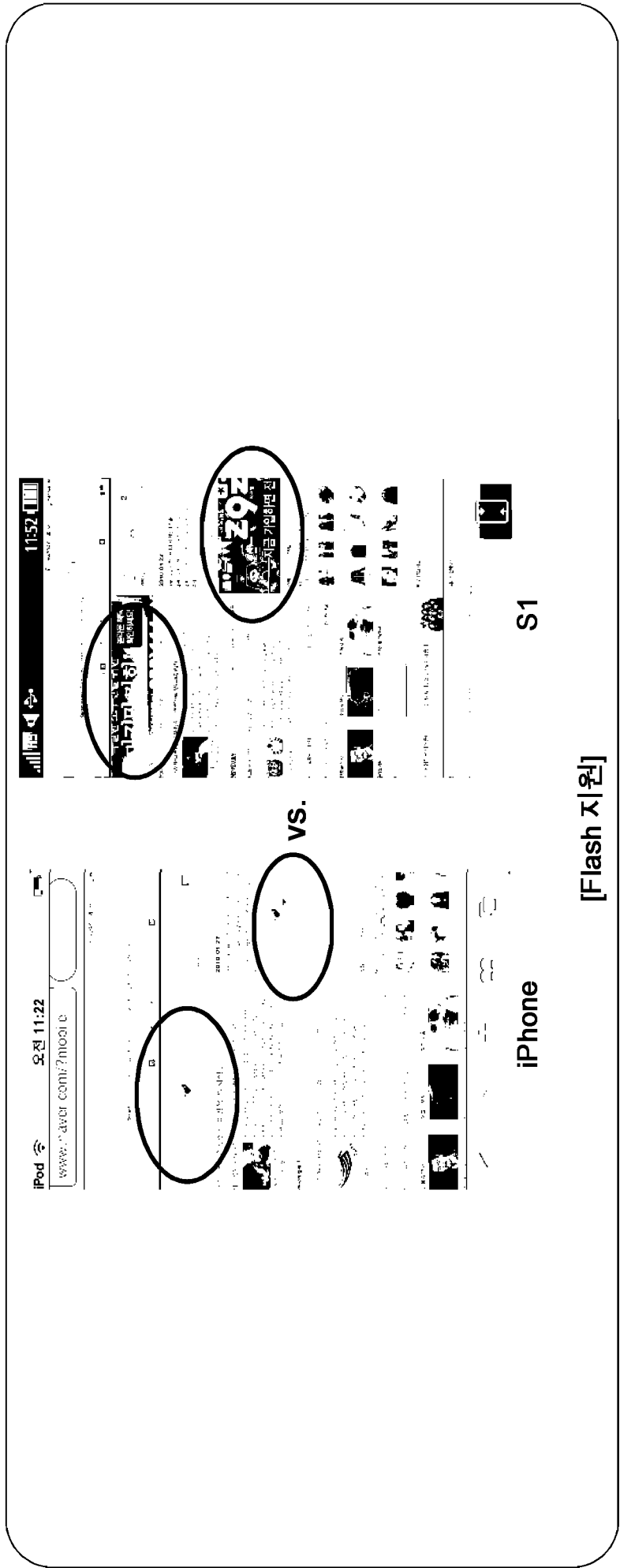

[Flash 지원]

# Special Embedded Features

## ● Layar

- Augmented-Reality 기반의 Social browser
  - ✓ Camera View를 통해 사용자가 원하는 Contents 위치를 Icon으로 표시 (Wikipedia, 식당 위치 및 전화번호, 타인의 SNS 등)

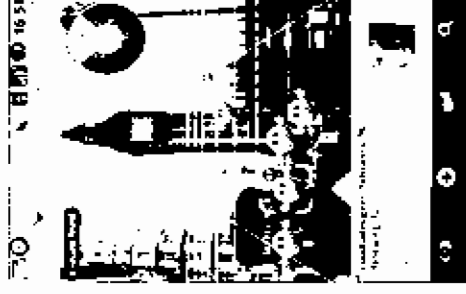

## ● EverNote

- Text, Photo, Audio 등의 방식으로 Anytime, Anywhere Record & Access 가능
  - ✓ Text, photo & audio notes 작성 가능
  - ✓ Image내에 있는 Text search 가능
  - ✓ 작성된 모든 Note는 Phone, PC, Server간 Share 및 Sync 가능



## ● FlipFont **fl!pfont**

- Phone Title/Menu 등을 사용자가 Download 받은 Font로 변경 가능
  - 사용자 취향에 맞춰 Customizing 가능

# Enhanced Connectivity (1)

- **Faster, Broader, and More Efficient Wi-Fi Experience**
  - 802.11 b/g + 802.11 n 지원함으로써 Wireless Access 성능 향상



## - Wi-Fi 사용성 개선

(Image 변경 예정)

- ✓ Quick Panel : Idle 화면에서 Wi-Fi on/off 설정 가능
- ✓ Auto Connecting : AP Search 후 자주 접속하는 AP 발견 시 WiFi 자동 접속 가능

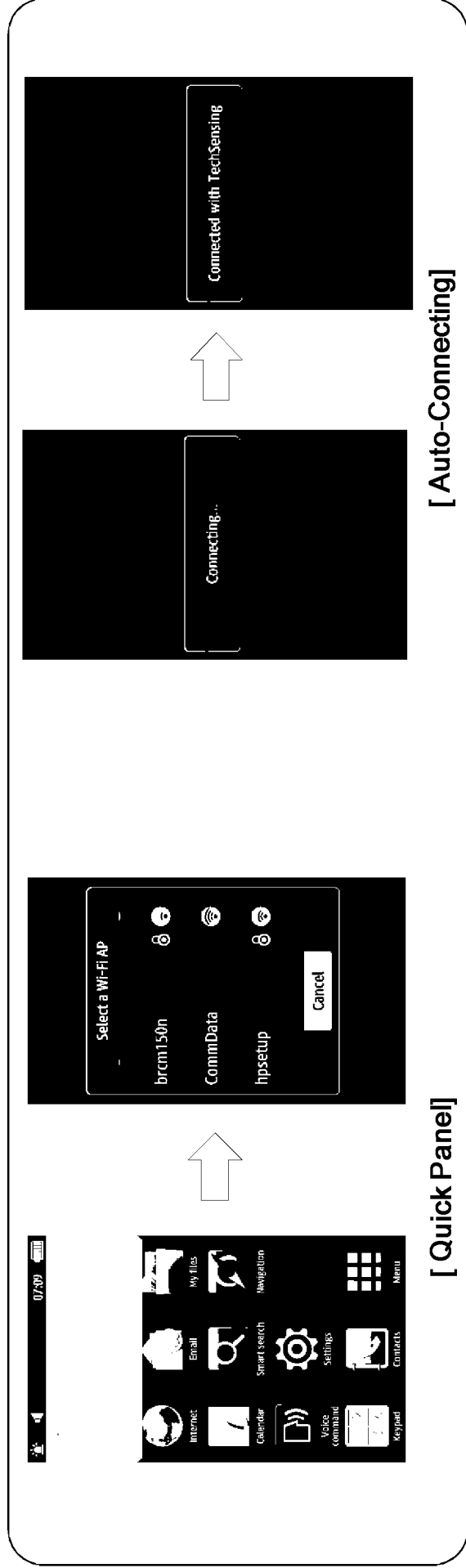

# Enhanced Connectivity (2)

## ● Upgrade Short-Distance Communication, Bluetooth™ 3.0

- 다양한 Bluetooth 3.0 Profile 지원함으로써 휴대폰을 통한 근거리 통신 활용 확대
- ✓ BPP (Remote Printing), FTP (File 전송) 등 iPhone 未지원 기능 추가

## ● Mobile AP

- 휴대폰을 Wireless Access Point로 활용하는

Tethering Application 지원

→ Wi-Fi 기능이 포함된 Mobile Device에서

휴대폰을 통해 3G N/W 통신 가능

→ AnyTime & AnyWhere Internet 사용 가능

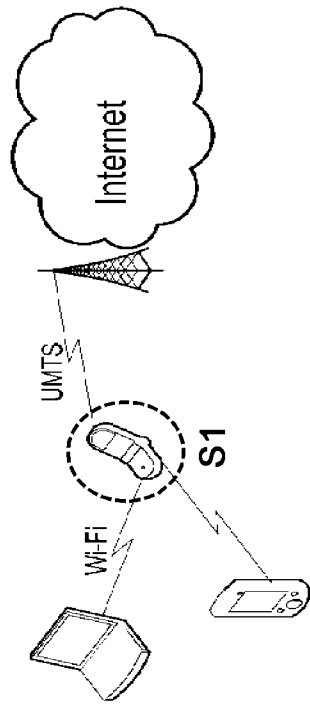

**- END -**