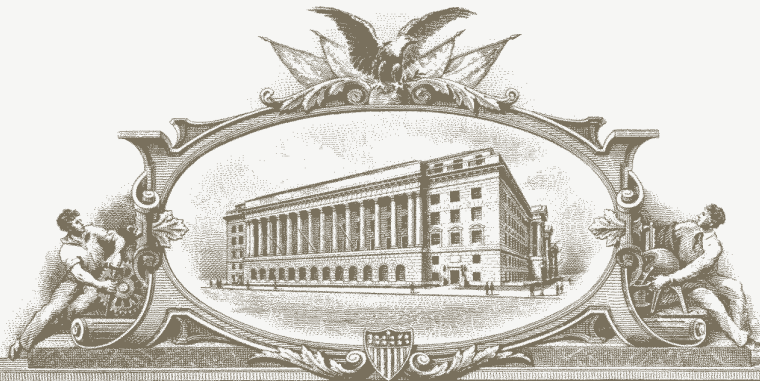

Exhibit E

U 7293220



THE UNITED STATES OF AMERICA

TO ALL TO WHOM THESE PRESENTS SHALL COME:

**UNITED STATES DEPARTMENT OF COMMERCE
United States Patent and Trademark Office**

April 26, 2011

**THIS IS TO CERTIFY THAT ANNEXED HERETO IS A TRUE COPY FROM
THE RECORDS OF THIS OFFICE OF:**

**U.S. PATENT: 7,844,915
ISSUE DATE: November 30, 2010**

**By Authority of the
Under Secretary of Commerce for Intellectual Property
and Director of the United States Patent and Trademark Office**



**P. SWAIN
Certifying Officer**



US007844915B2

(12) **United States Patent**
Platzer et al.

(10) **Patent No.:** **US 7,844,915 B2**
(45) **Date of Patent:** **Nov. 30, 2010**

- (54) **APPLICATION PROGRAMMING INTERFACES FOR SCROLLING OPERATIONS**
- | | | |
|--------------|---------|----------------|
| 7,009,626 B2 | 3/2006 | Anwar |
| 7,088,374 B2 | 8/2006 | David et al. |
| 7,117,453 B2 | 10/2006 | Drucker et al. |
| 7,173,623 B2 | 2/2007 | Calkins et al. |
| 7,337,412 B2 | 2/2008 | Guido et al. |
| 7,346,850 B2 | 3/2008 | Swartz et al. |
- (75) Inventors: **Andrew Platzer**, Santa Clara, CA (US);
Scott Herz, Santa Clara, CA (US)
- (73) Assignee: **Apple Inc.**, Cupertino, CA (US)
- (*) Notice: Subject to any disclaimer, the term of this patent is extended or adjusted under 35 U.S.C. 154(b) by 583 days.

(Continued)

FOREIGN PATENT DOCUMENTS

- (21) Appl. No.: **11/620,717**
- (22) Filed: **Jan. 7, 2007**
- | | | |
|----|---------|--------|
| EP | 1517228 | 3/2005 |
|----|---------|--------|

- (65) **Prior Publication Data**
US 2008/0168384 A1 Jul. 10, 2008

(Continued)

OTHER PUBLICATIONS

- (51) **Int. Cl.**
G06F 3/00 (2006.01)
G06F 3/033 (2006.01)
G06F 3/041 (2006.01)
G06F 3/048 (2006.01)
- (52) **U.S. Cl.** **715/781; 715/784; 715/800; 345/173**
- (58) **Field of Classification Search** **715/764, 715/765, 784, 786, 788, 800, 864, 866, 973, 715/974; 345/156, 157, 169, 173**
See application file for complete search history.
- Toshiyuki Masui et al; "Elastic Graphical Interfaces for Precise Data Manipulation", 1995; ACM; pp. 143-144.*
- (Continued)
- Primary Examiner*—Xiomara L. Bautista
(74) *Attorney, Agent, or Firm*—Blakely, Sokoloff, Taylor & Zafman LLP

(57) **ABSTRACT**

At least certain embodiments of the present disclosure include an environment with user interface software interacting with a software application. A method for operating through an application programming interface (API) in this environment includes transferring a set bounce call. The method further includes setting at least one of maximum and minimum bounce values. The set bounce call causes a bounce of a scrolled region in an opposite direction of a scroll based on a region past an edge of the scrolled region being visible in a display region at the end of the scroll.

- (56) **References Cited**
- U.S. PATENT DOCUMENTS**
- | | | |
|----------------|---------|--------------------------------|
| 5,534,893 A | 7/1996 | Hansen et al. |
| 5,903,902 A | 5/1999 | Orr et al. |
| 6,028,602 A | 2/2000 | Weidenfeller et al. |
| 6,486,896 B1 | 11/2002 | Ubillos |
| 6,677,965 B1 * | 1/2004 | Ullmann et al. 715/786 |
| 6,741,996 B1 | 5/2004 | Brechner et al. |
| 6,839,721 B2 | 1/2005 | Schwols |
| 6,903,927 B2 | 6/2005 | Anlauff |
| 6,957,392 B2 | 10/2005 | Simister et al. |
| 6,958,749 B1 * | 10/2005 | Matsushita et al. 345/175 |

21 Claims, 37 Drawing Sheets

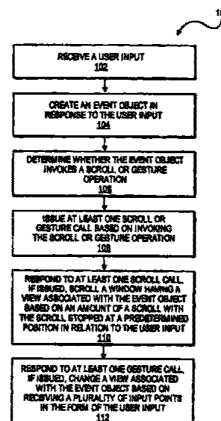

US 7,844,915 B2

Page 2

U.S. PATENT DOCUMENTS

7,561,159	B2	7/2009	Abel et al.	
7,576,732	B2 *	8/2009	Lii	345/173
2001/0045949	A1	11/2001	Chithambaram et al.	
2002/0194589	A1	12/2002	Cristofalo et al.	
2003/0095096	A1	5/2003	Robbin et al.	
2003/0122787	A1	7/2003	Zimmerman et al.	
2003/0132959	A1	7/2003	Simister et al.	
2003/0160832	A1	8/2003	Ridgley et al.	
2003/0174149	A1	9/2003	Fujisaki et al.	
2004/0021676	A1	2/2004	Chen et al.	
2004/0021698	A1	2/2004	Baldwin et al.	
2004/0100479	A1	5/2004	Nakano et al.	
2004/0215643	A1	10/2004	Brechner et al.	
2004/0222992	A1	11/2004	Calkins et al.	
2004/0224638	A1	11/2004	Fadell et al.	
2005/0057524	A1 *	3/2005	Hill et al.	345/173
2005/0088443	A1	4/2005	Blanco et al.	
2005/0193015	A1	9/2005	Logston et al.	
2006/0038796	A1 *	2/2006	Hinckley et al.	345/173
2006/0190833	A1	8/2006	SanGiovanni et al.	
2006/0236263	A1 *	10/2006	Bathiche et al.	715/786
2007/0055967	A1	3/2007	Poff et al.	
2007/0075965	A1	4/2007	Huppi et al.	
2007/0174257	A1	7/2007	Howard	
2007/0185876	A1	8/2007	Mendis et al.	
2007/0252821	A1 *	11/2007	Hollems et al.	345/173
2007/0288856	A1	12/2007	Butlin et al.	
2008/0005703	A1 *	1/2008	Radivojevic et al.	715/863
2008/0016096	A1	1/2008	Wilding et al.	
2008/0034029	A1	2/2008	Fang et al.	
2008/0048978	A1 *	2/2008	Trent et al.	345/157
2008/0168395	A1 *	7/2008	Ording et al.	715/833
2008/0231610	A1 *	9/2008	Hotelling et al.	345/173
2009/0259969	A1 *	10/2009	Pallakoff	715/808

FOREIGN PATENT DOCUMENTS

GB	2 319 591 A	5/1998
GB	2319591 A *	5/1998

WO	WO-2006/067711	6/2006
WO	WO 2008/085848 A1 *	7/2008
WO	WO 2008/085877 A1 *	7/2008
WO	WO-2008085848	7/2008
WO	WO-2008085877	7/2008

OTHER PUBLICATIONS

Office Action, U.S. Appl. No. 11/620,723, mailed Apr. 1, 2009, 8 pages.
 Office Action, U.S. Appl. No. 11/620,709, mailed Apr. 1, 2009, 8 pages.
 Office Action, U.S. Appl. No. 11/620,720, mailed Jun. 23, 2009, 17 pages.
 Office Action, U.S. Appl. No. 11/620,720, mailed Dec. 23, 2008, 18 pages.
 PCT International Search Report and Written Opinion for PCT International Appln. No. US2008/000058, mailed Jul. 31, 2008 (10 pages).
 PCT International Search Report and Written Opinion for PCT International Appln. No. US2008/000089, mailed Apr. 6, 2008 (14 pages).
 PCT International Search Report and Written Opinion for PCT International Appln. No. PCT/US2008/000103, mailed Jun. 3, 2008 (15 pages).
 PCT International Search Report and Written Opinion for PCT International Appln. No. PCT/US2008/000069, mailed May 2, 2008 (16 pages).
 PCT International Search Report and Written Opinion for PCT International Appin. No. PCT/US2008/000060, mailed Apr. 22, 2008 (12 pages).
 Office Action, U.S. Appl. No. 11/620,723, mailed Jun. 8, 2010, 7 pages.
 Office Action, U.S. Appl. No. 11/620,709, mailed Jun. 9, 2010, 7 pages.
 Final Office Action, U.S. Appl. No. 11/620,709 mailed Nov. 13, 2009, 8 pages.
 Final Office Action, U.S. Appl. No. 11/620,723, mailed Nov. 17, 2009., 10 pages.
 Office Action, U.S. Appl. No. 11/620,720 mailed Nov. 18, 2009, 17 pages.

* cited by examiner

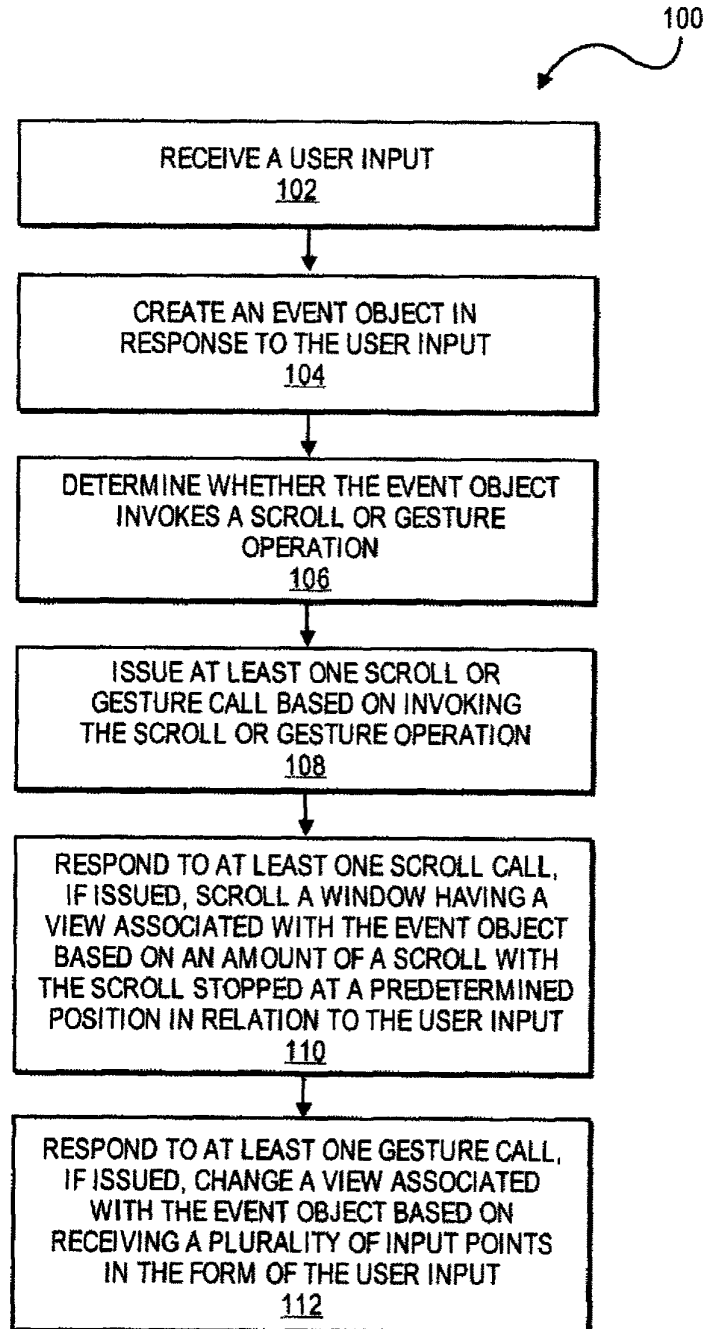

FIG. 1

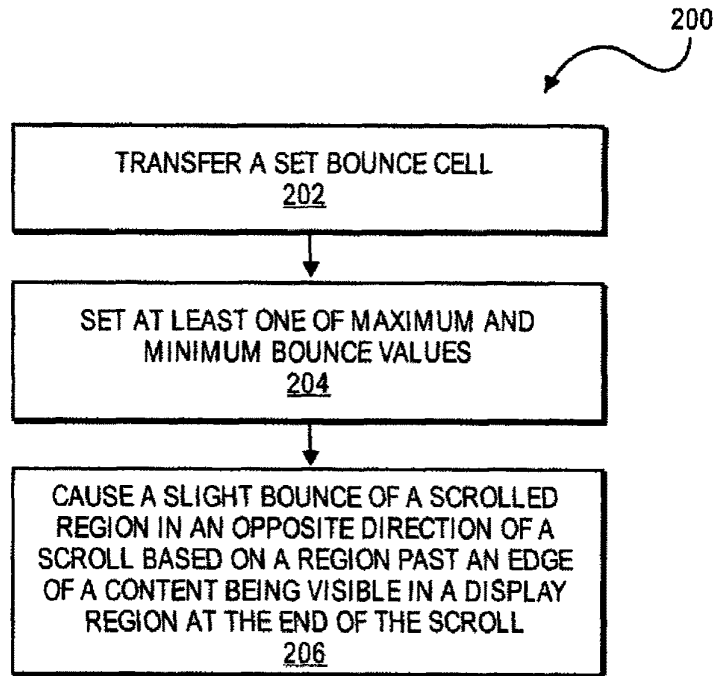

FIG. 2

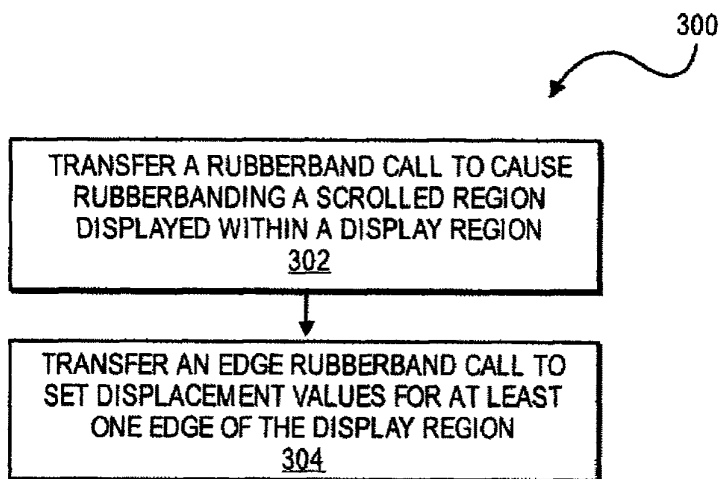

FIG. 3

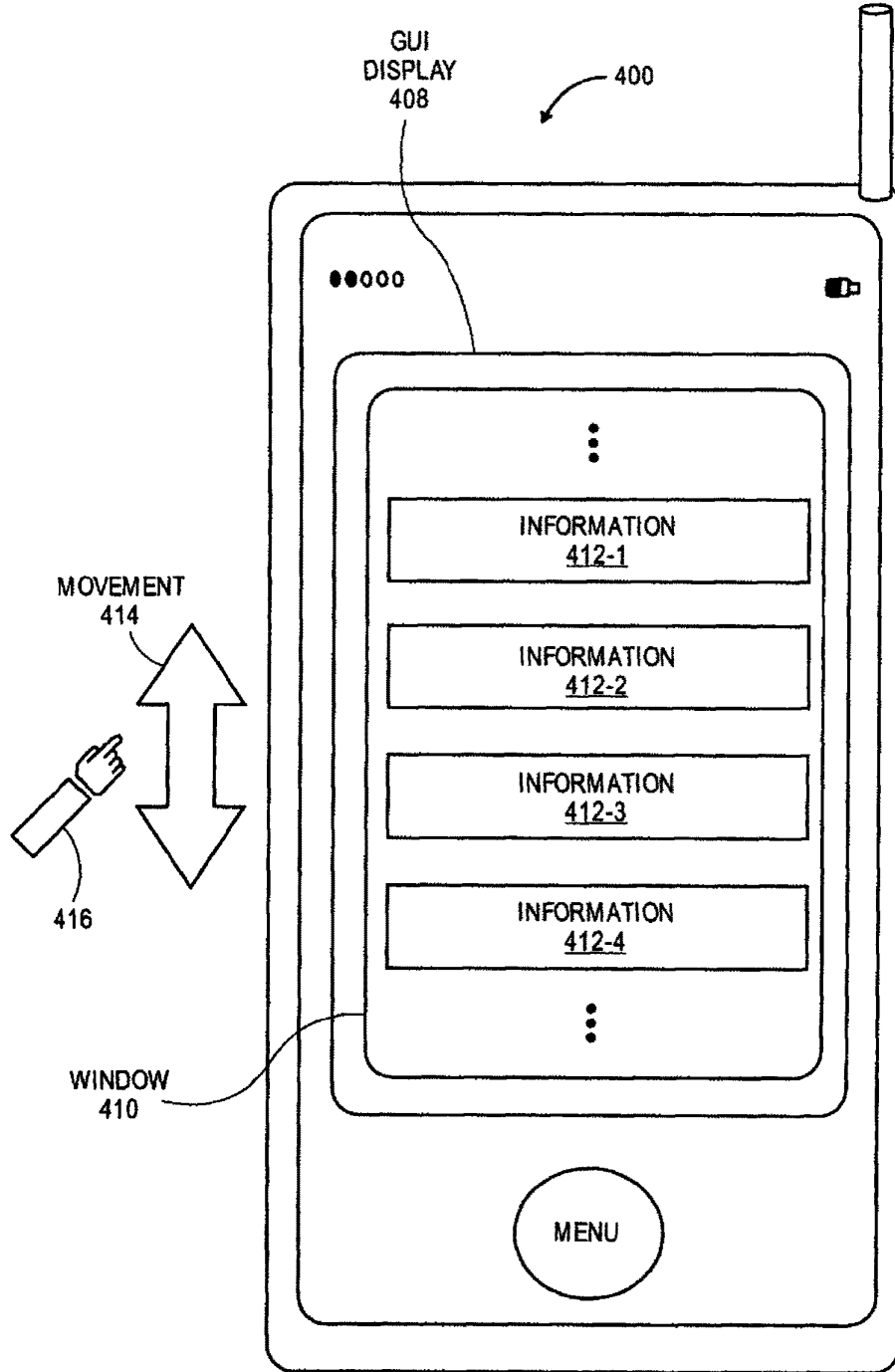

FIG. 4

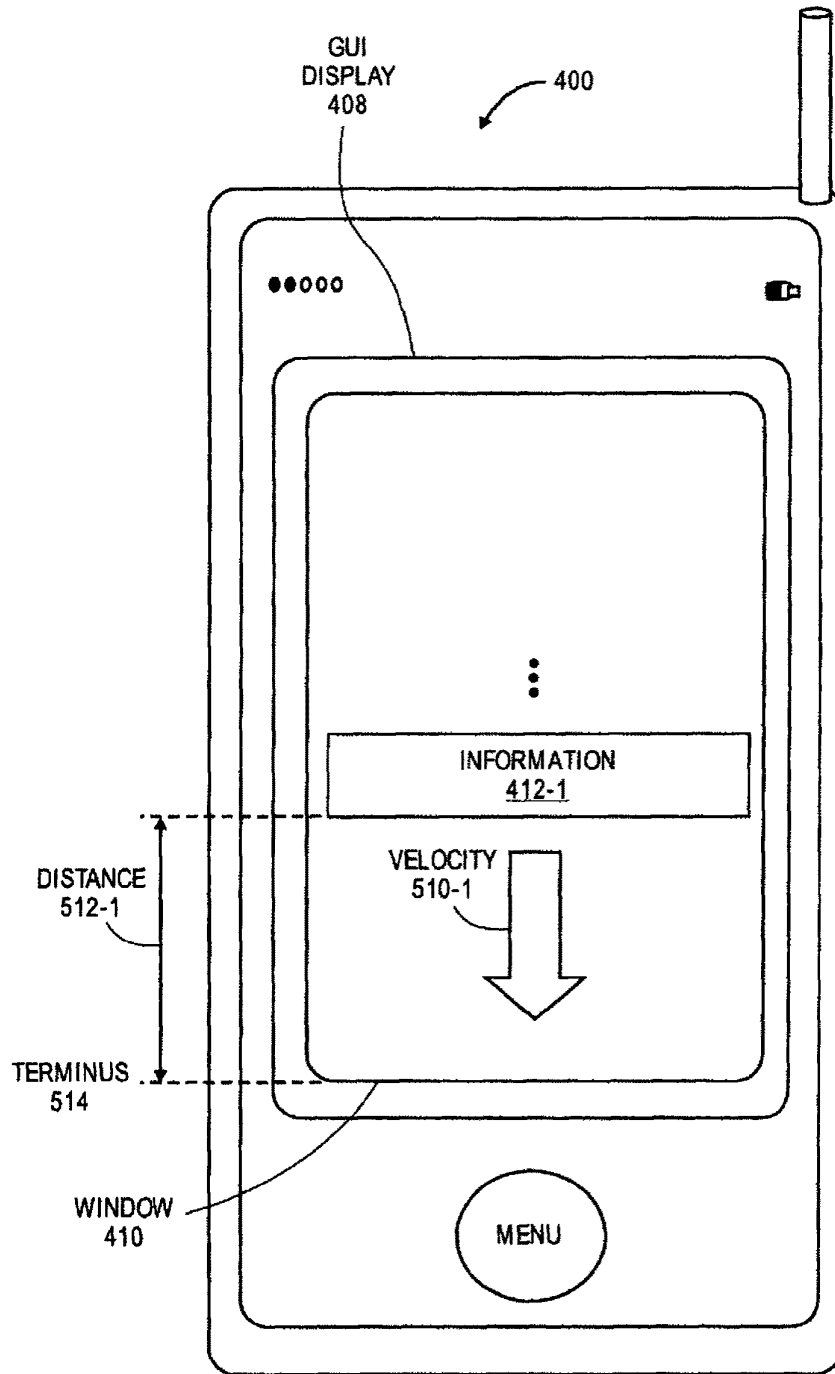

FIG. 5A

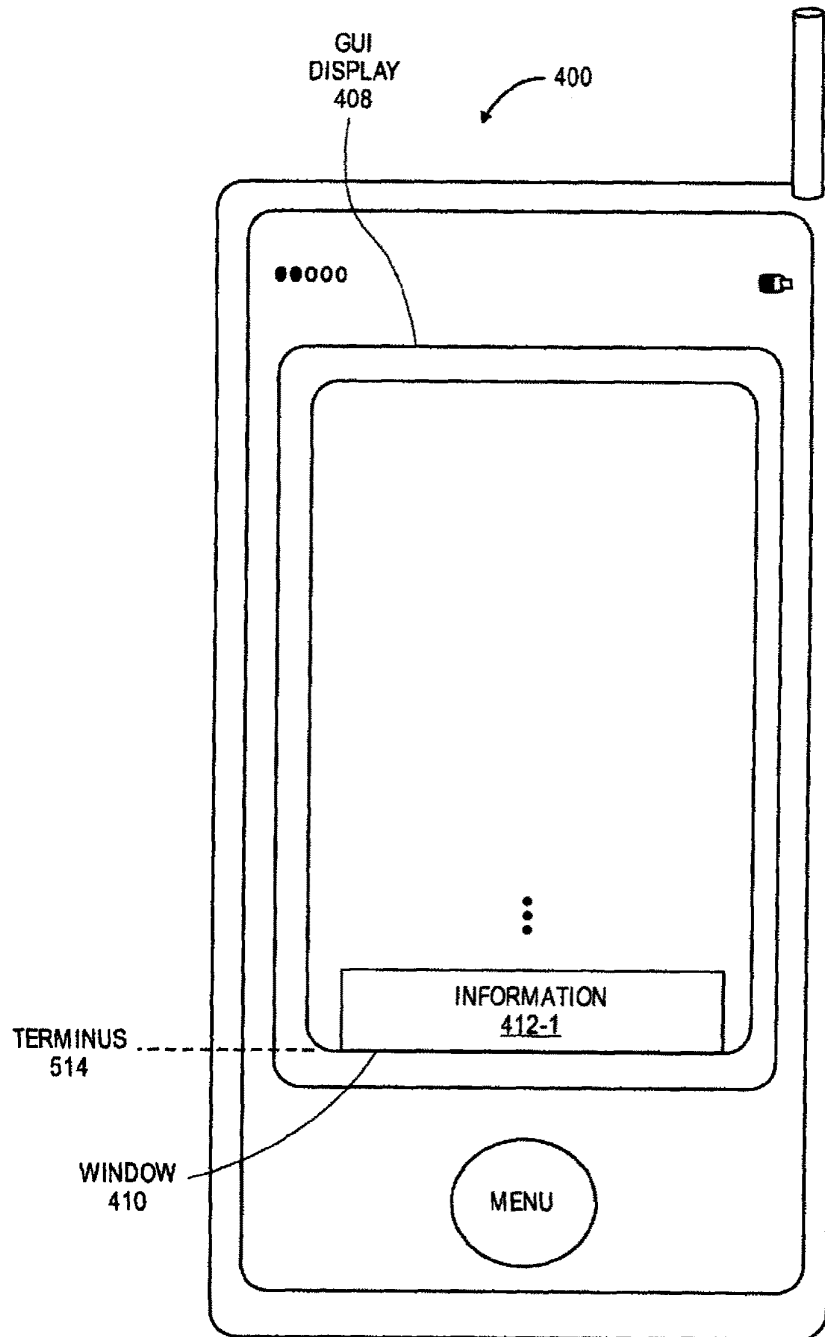

FIG. 5B

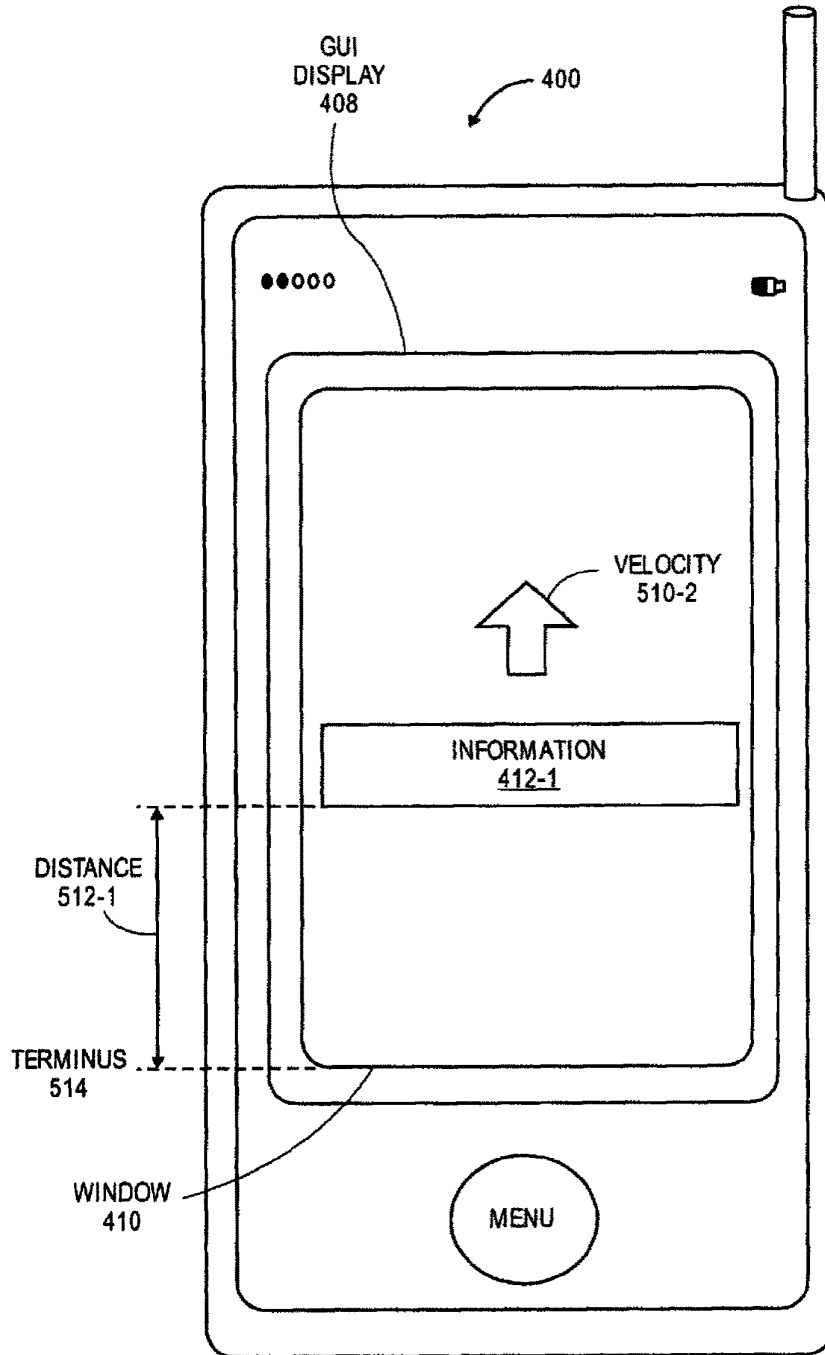

FIG. 5C

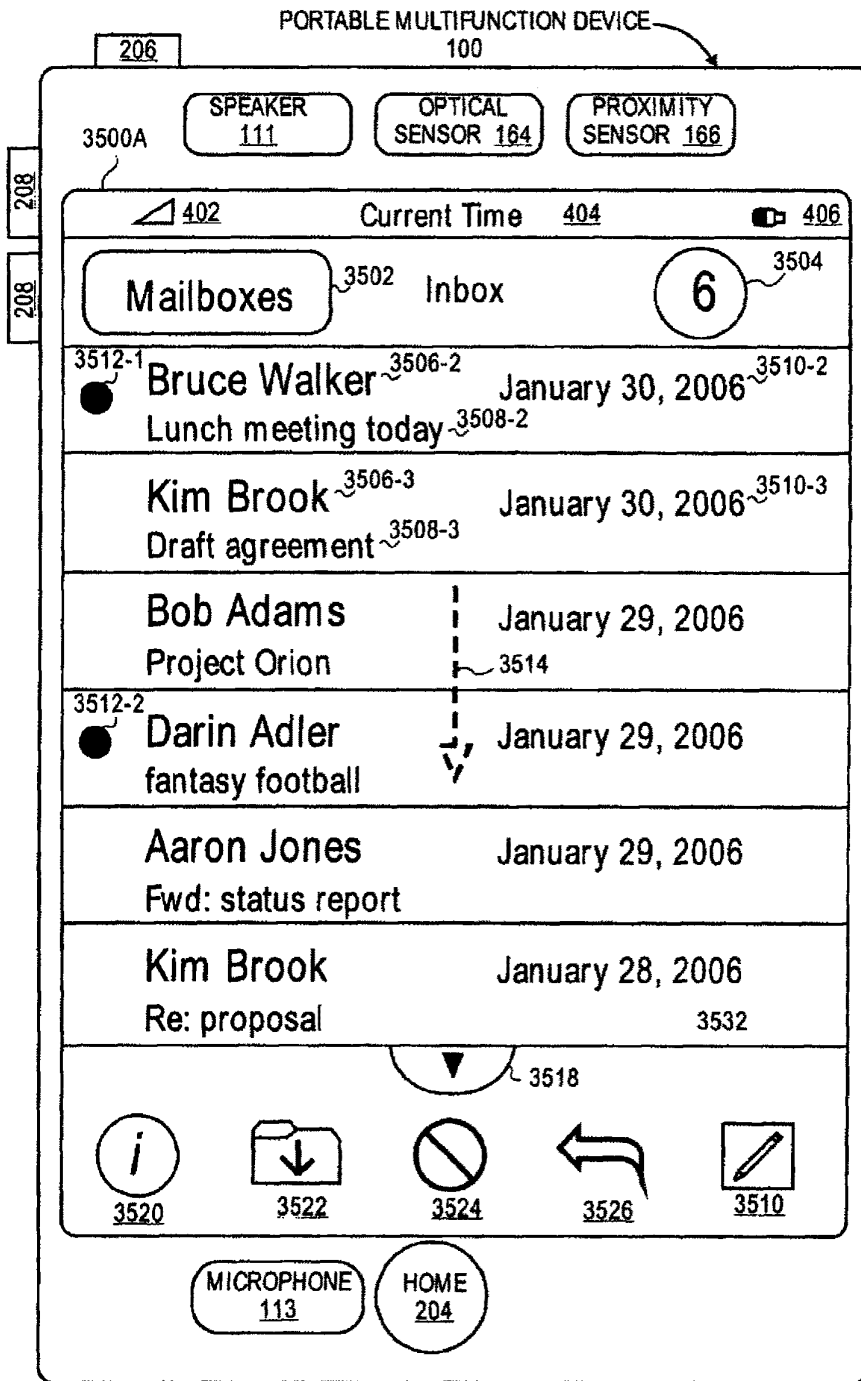

FIG. 6A

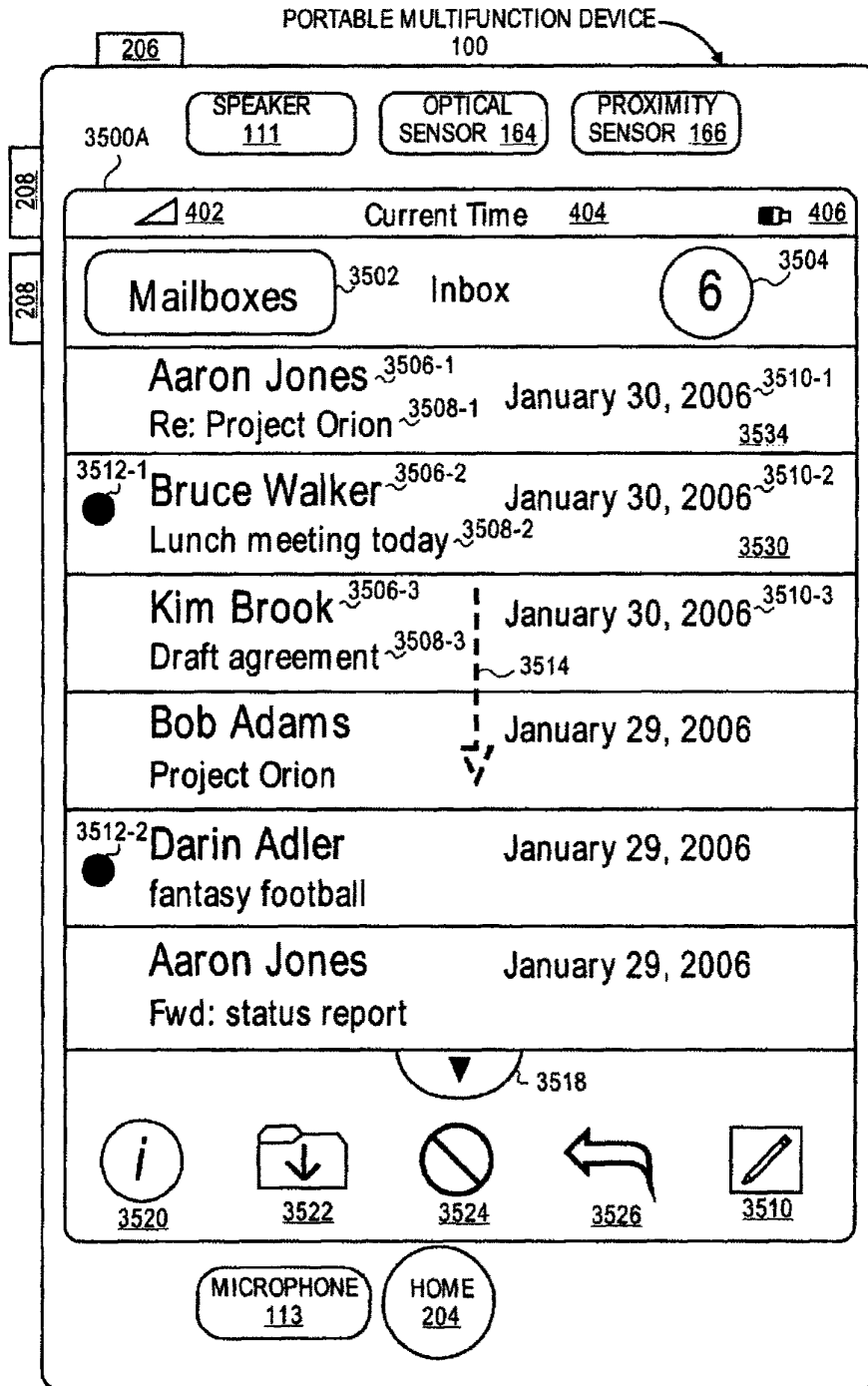

FIG. 6B

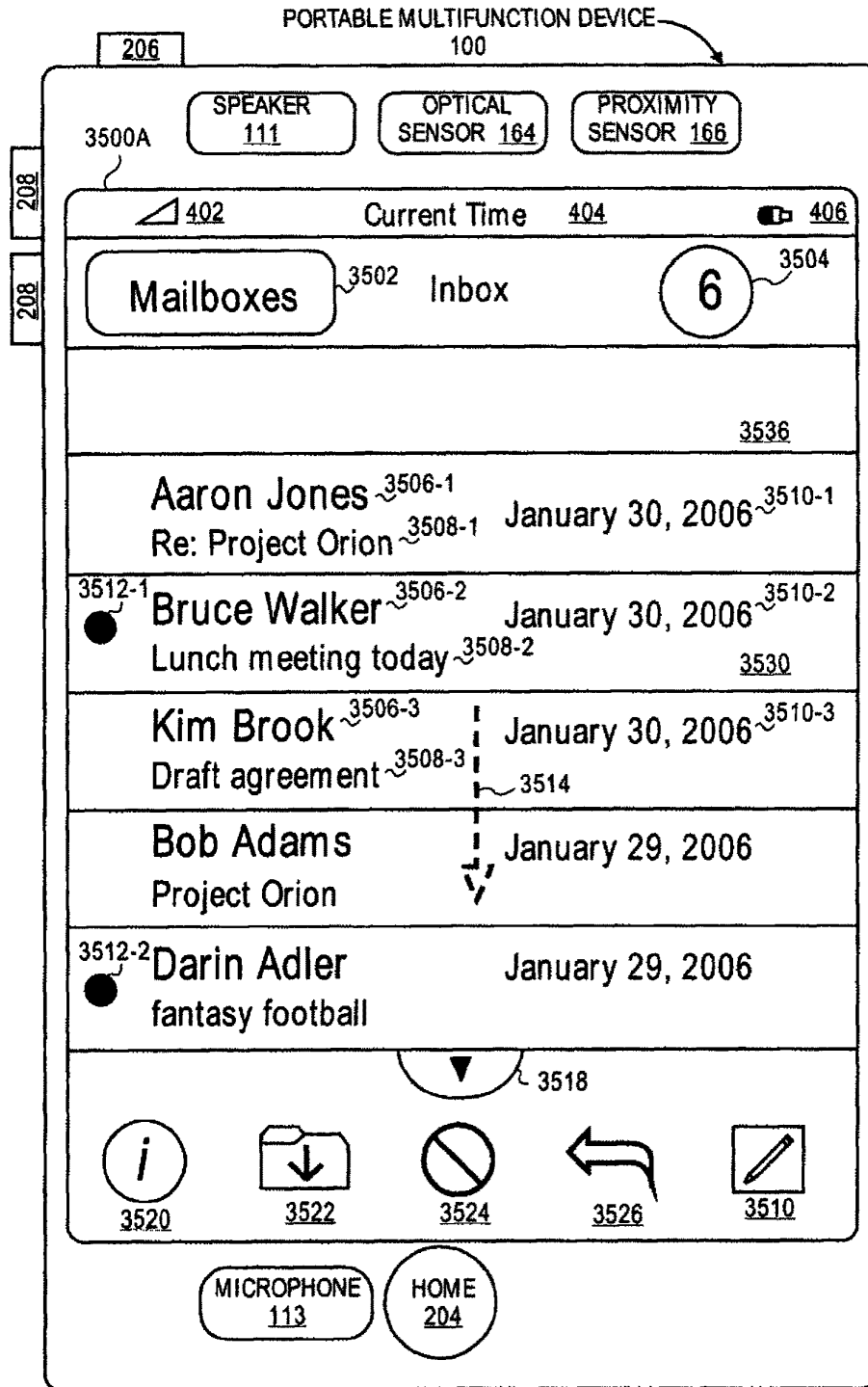

FIG. 6C

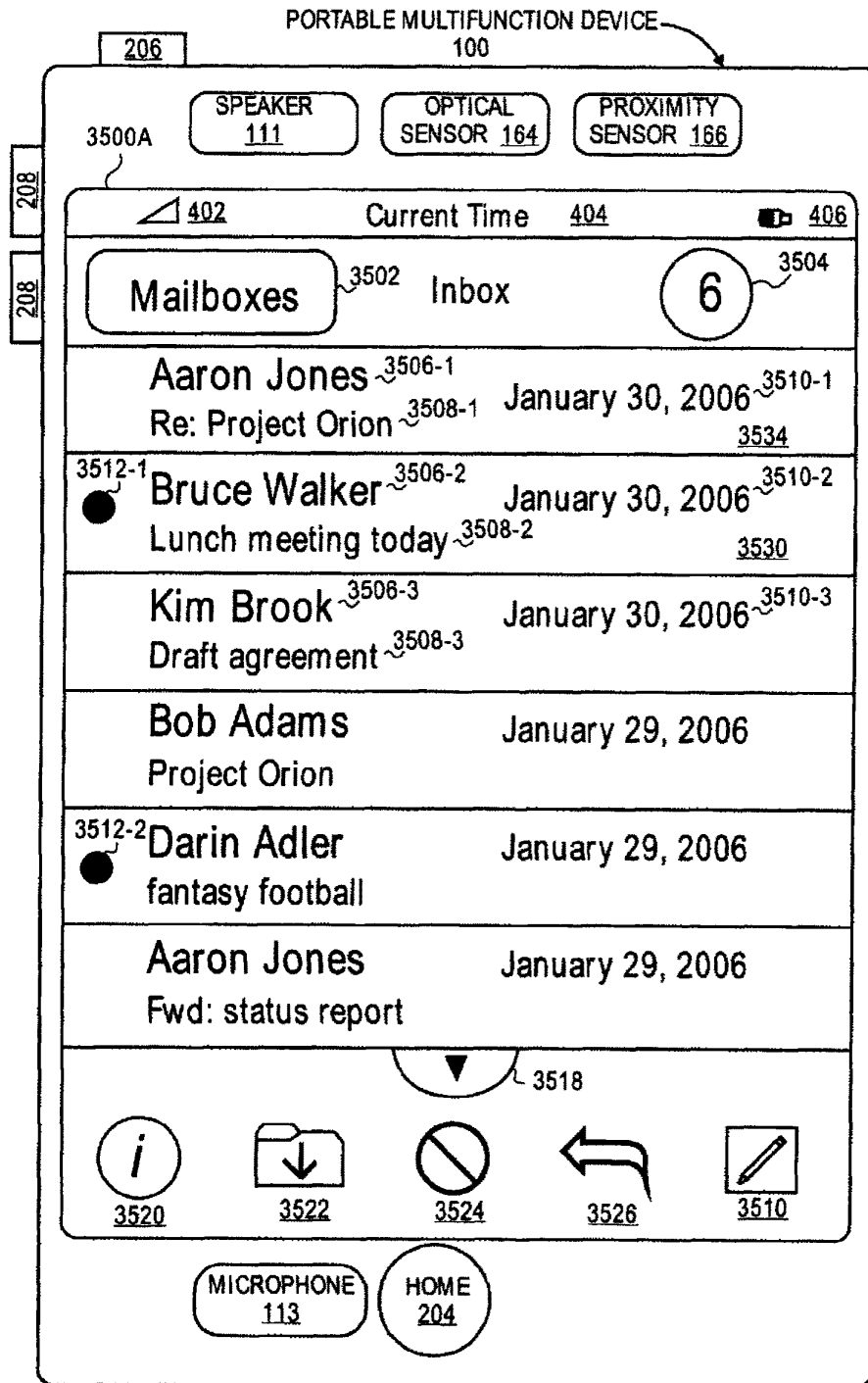
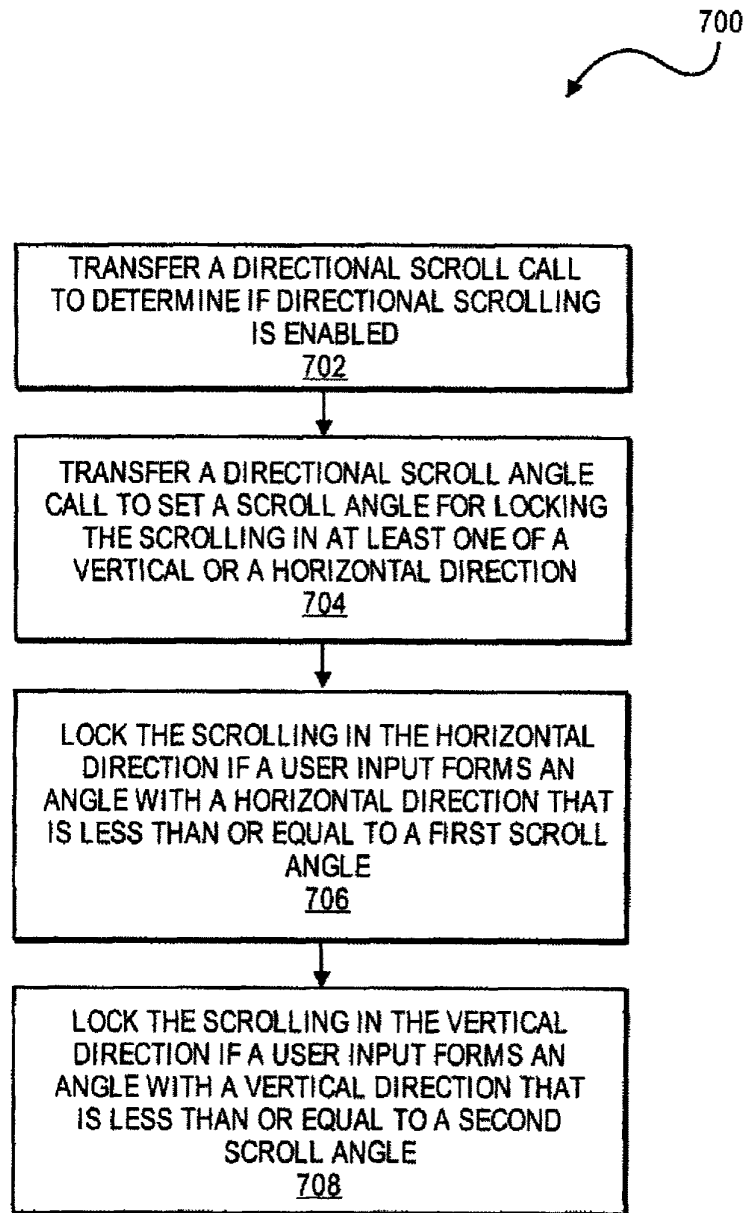

FIG. 6D

**FIG. 7**

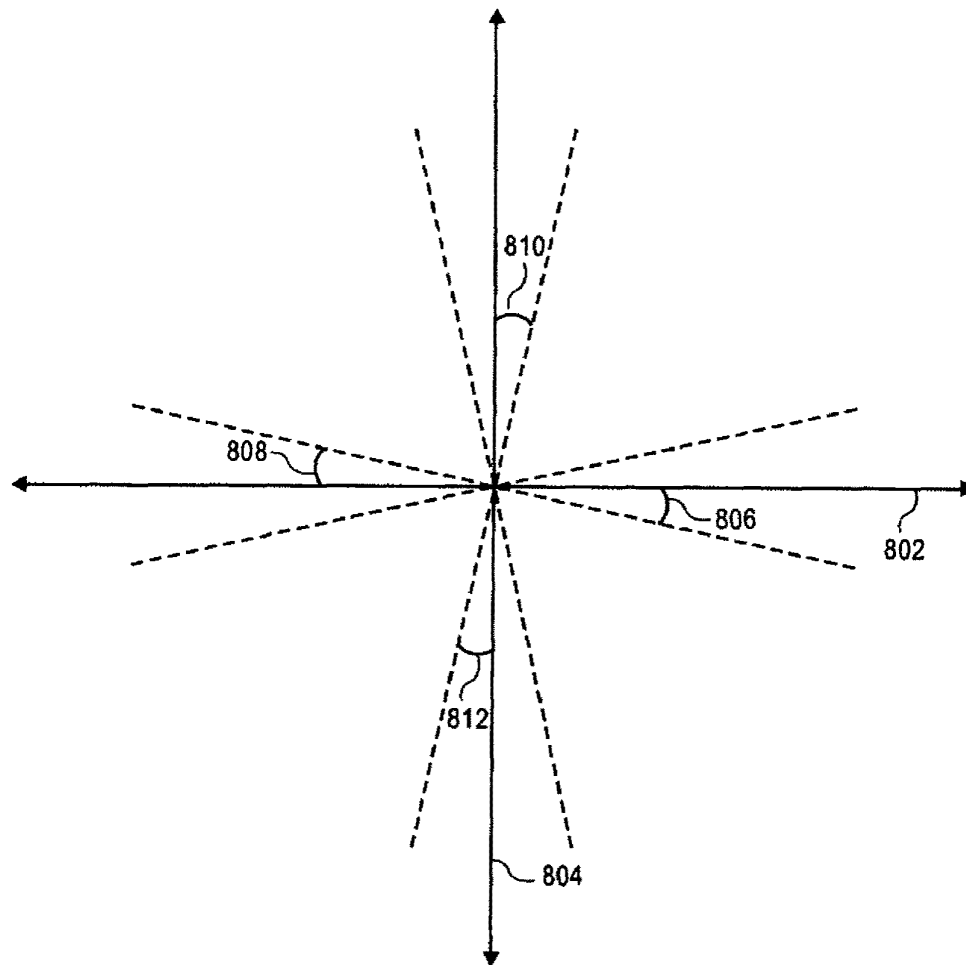

FIG. 8

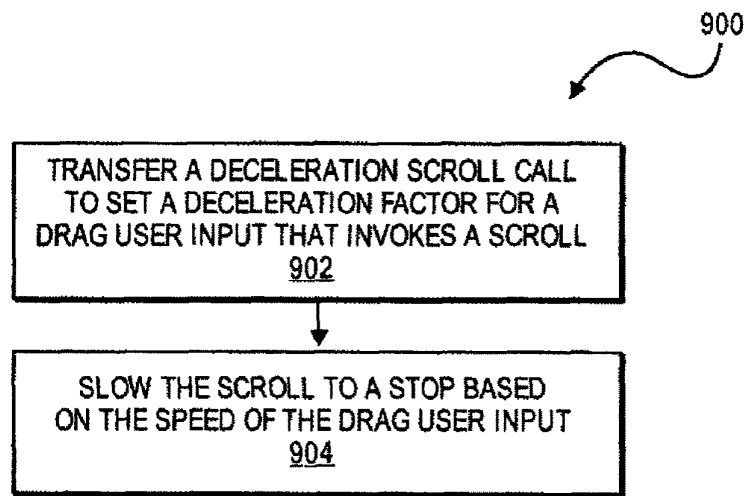

FIG. 9

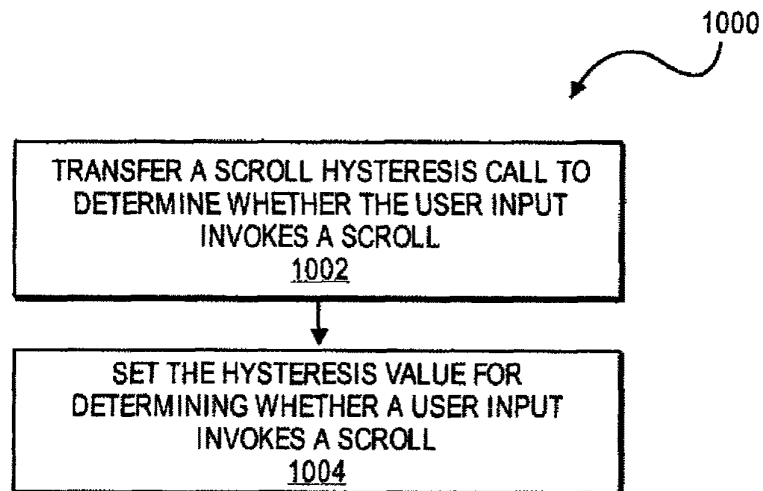

FIG. 10

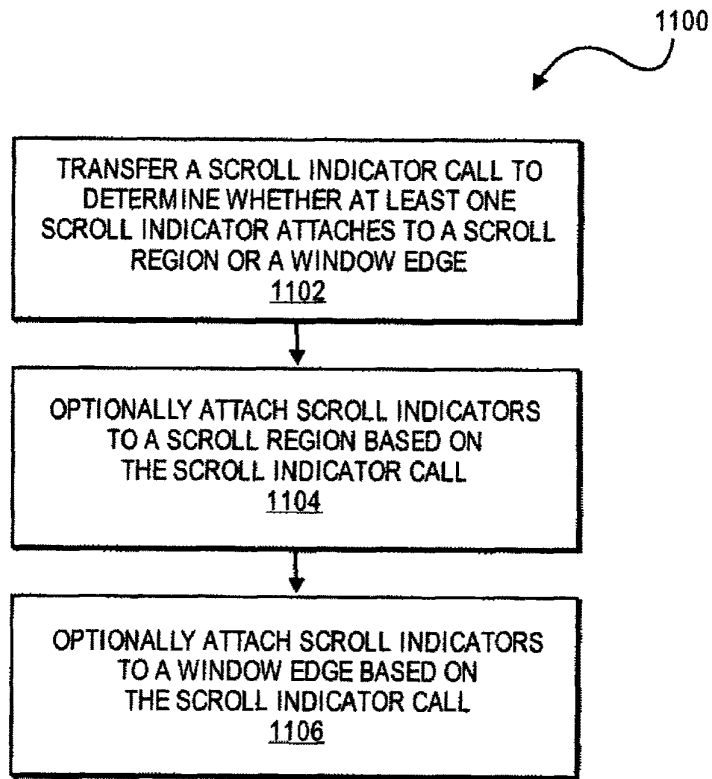

FIG. 11

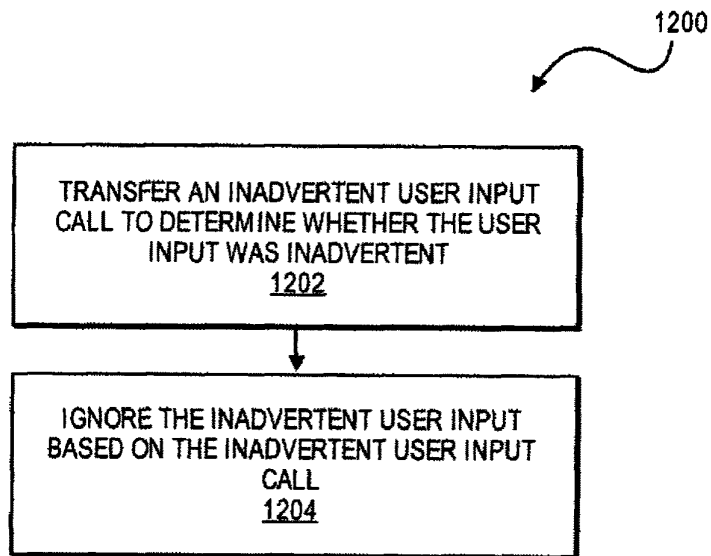

FIG. 12

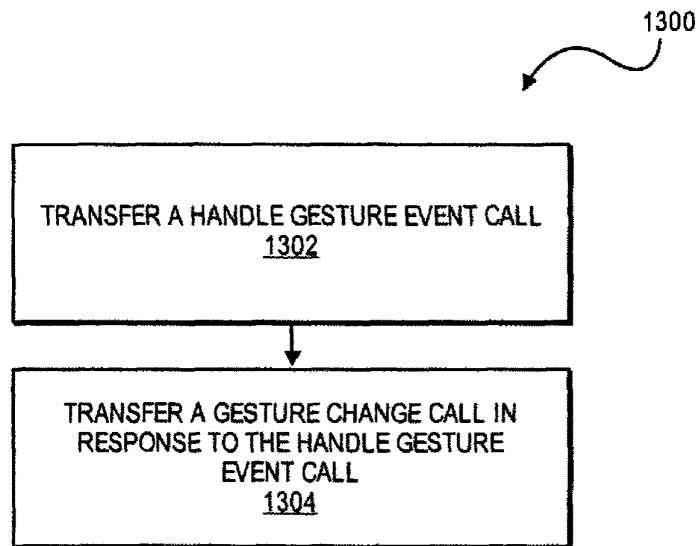

FIG. 13

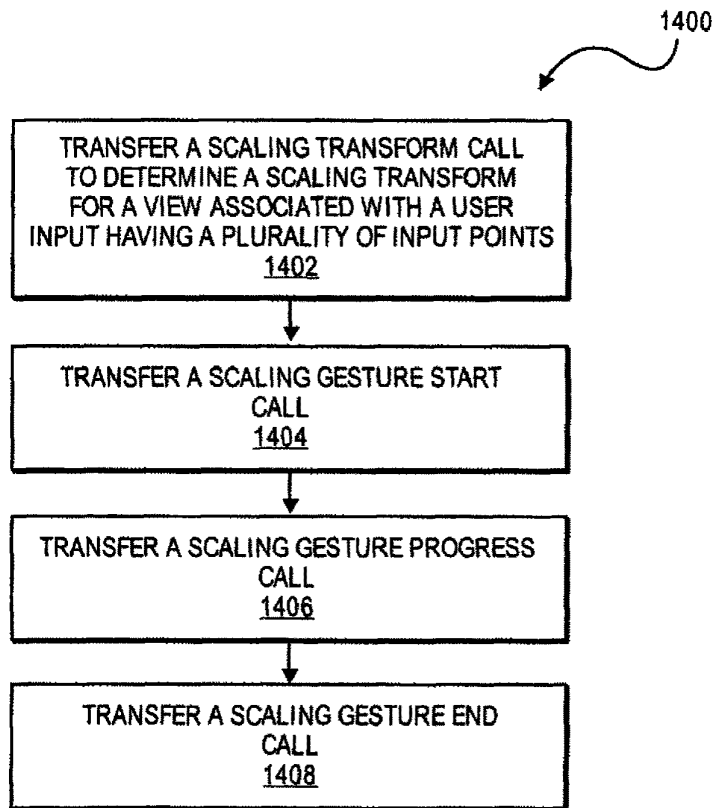

FIG. 14

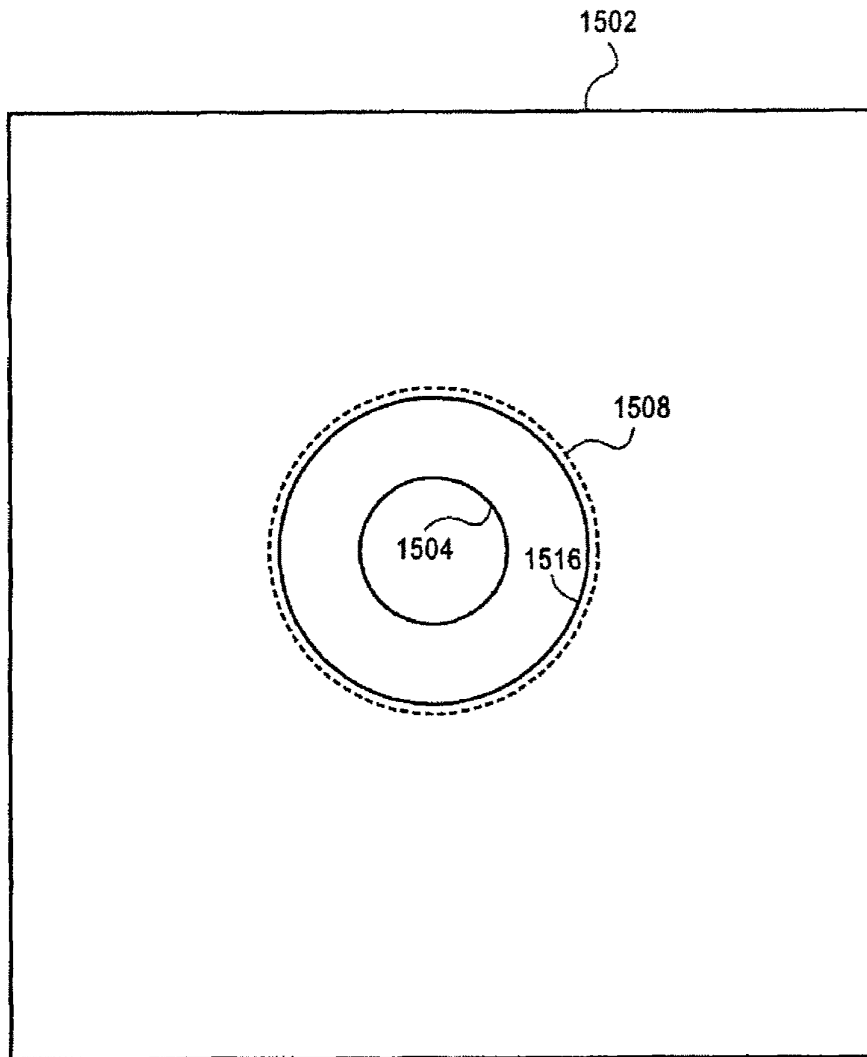
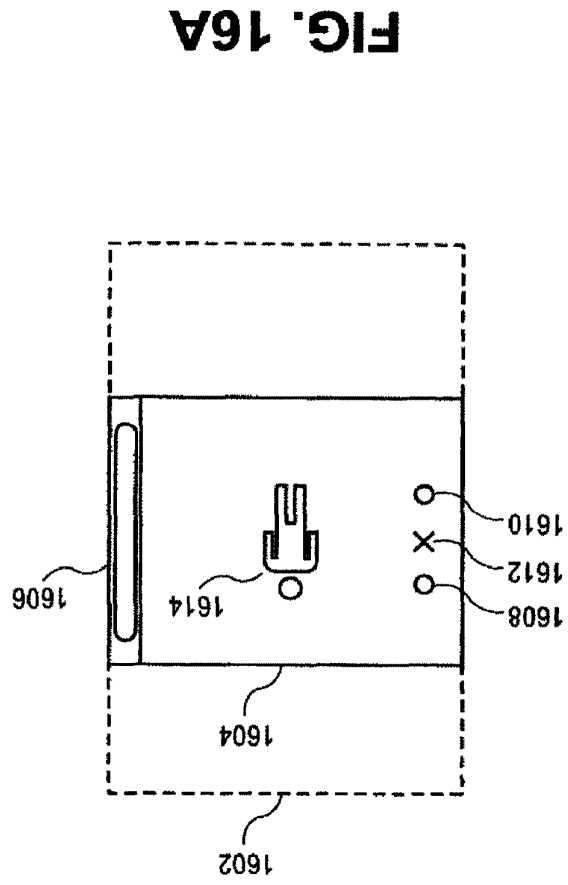
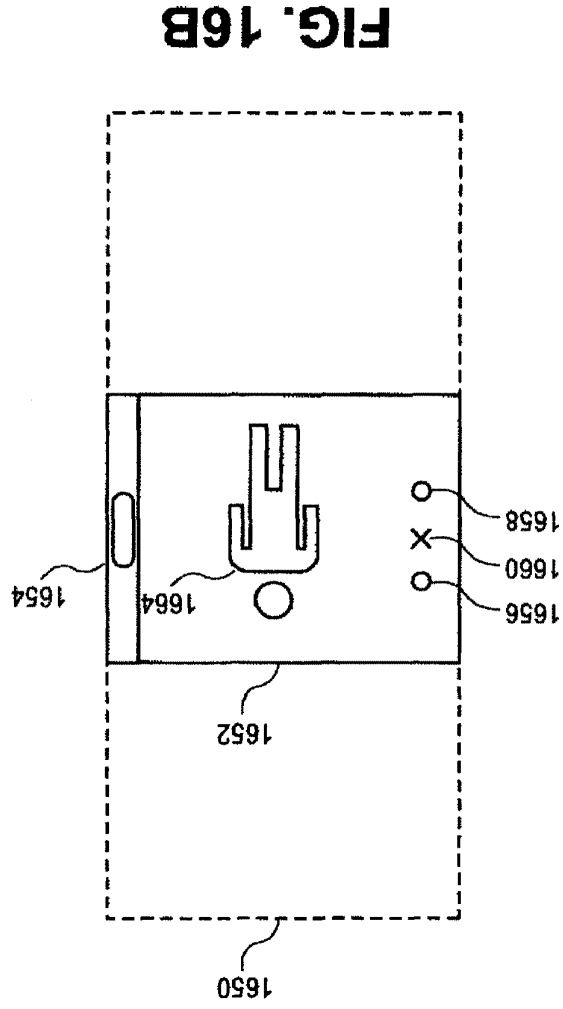

FIG. 15



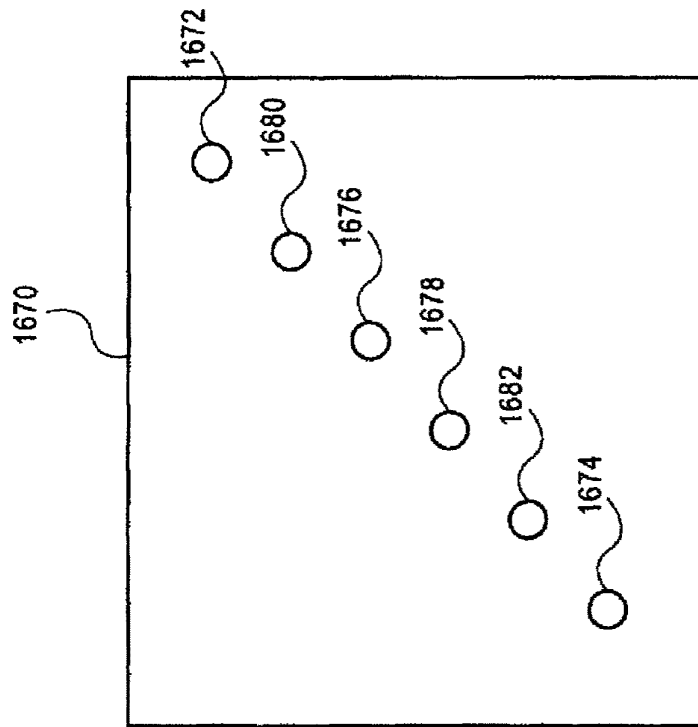

FIG. 16C

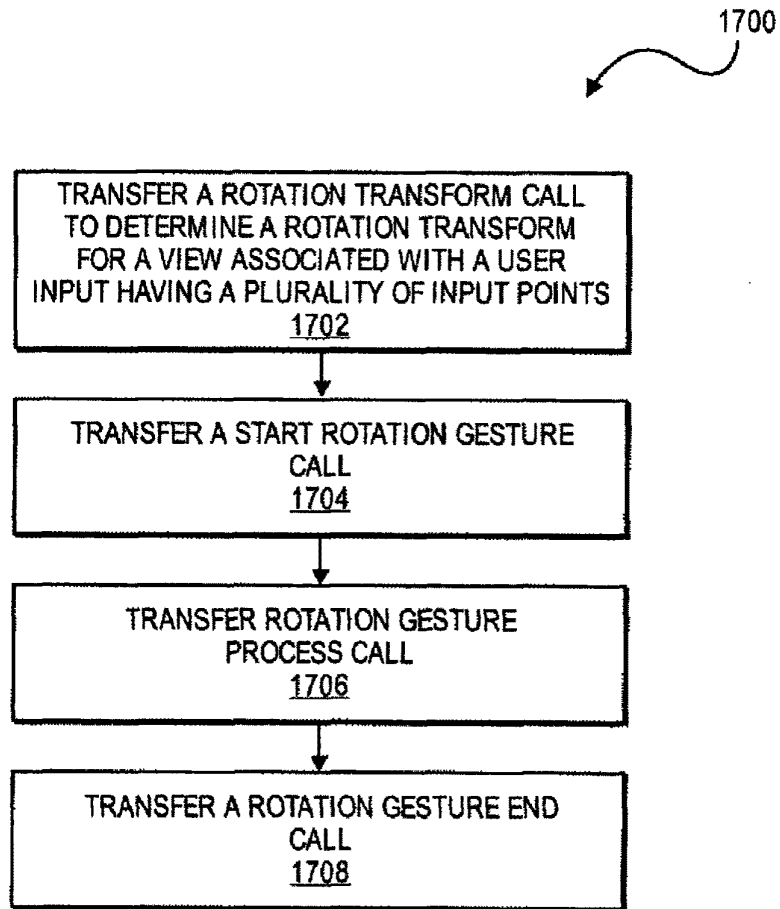

FIG. 17

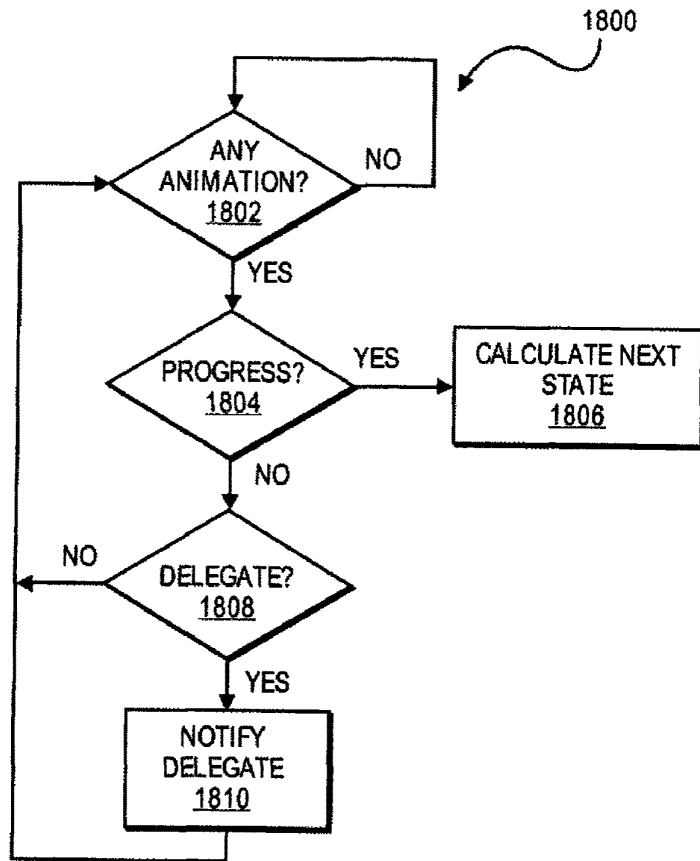

FIG. 18

1900

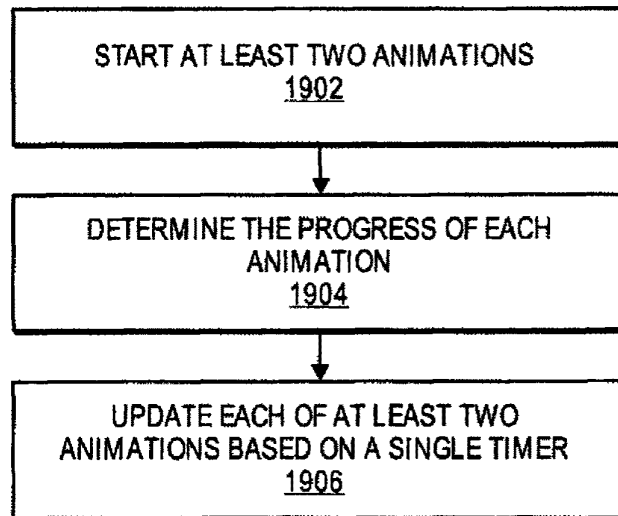

FIG. 19

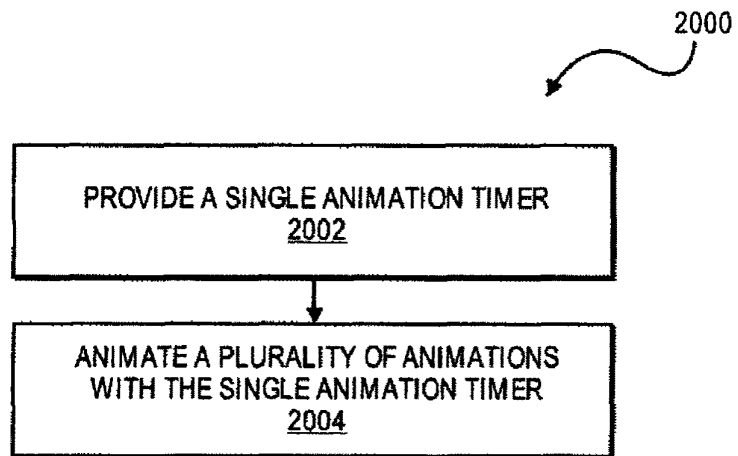
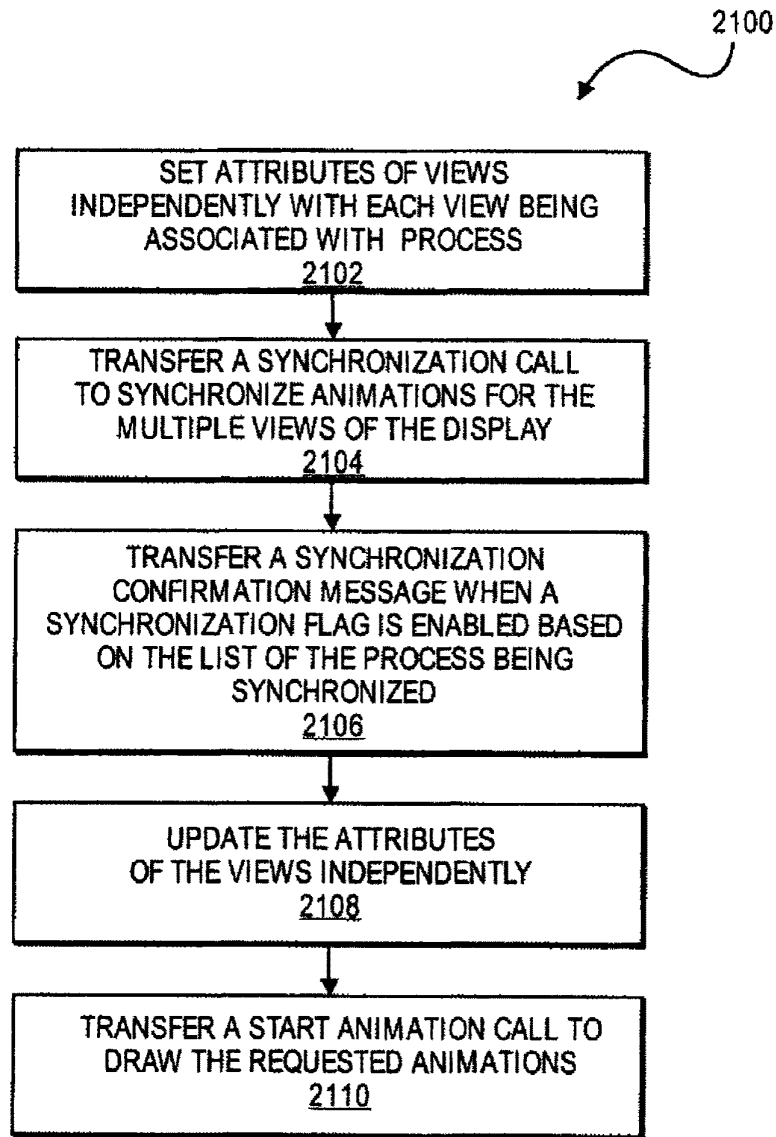

FIG. 20

**FIG. 21**

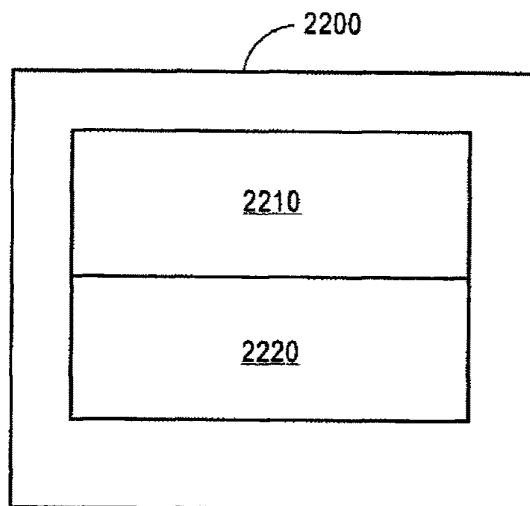

FIG. 22A

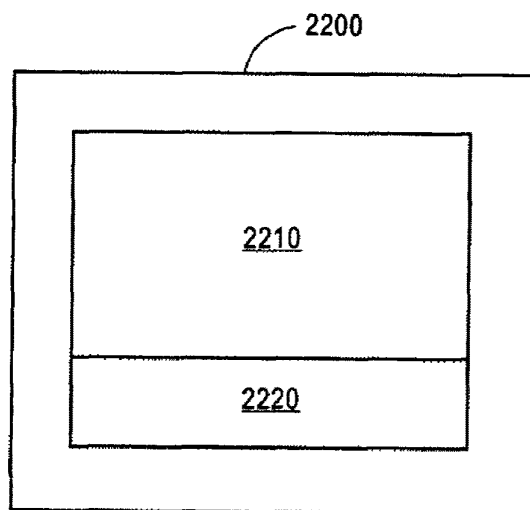
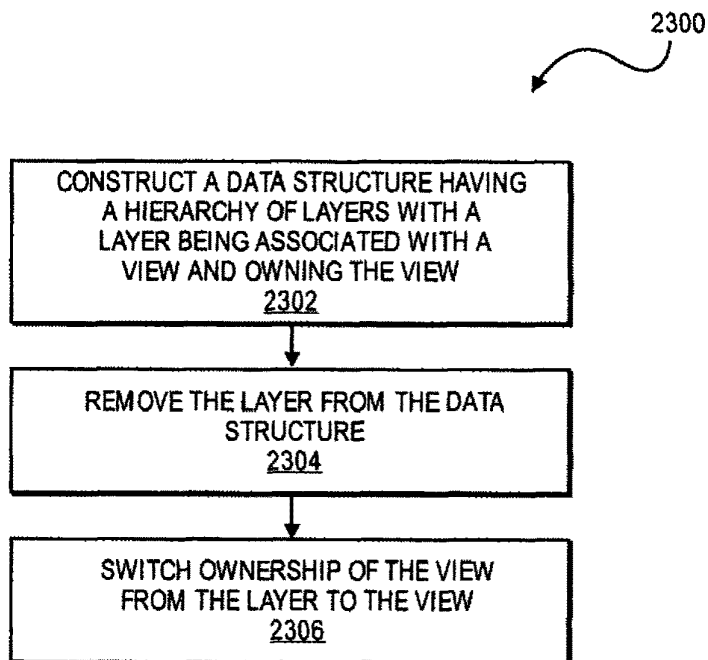
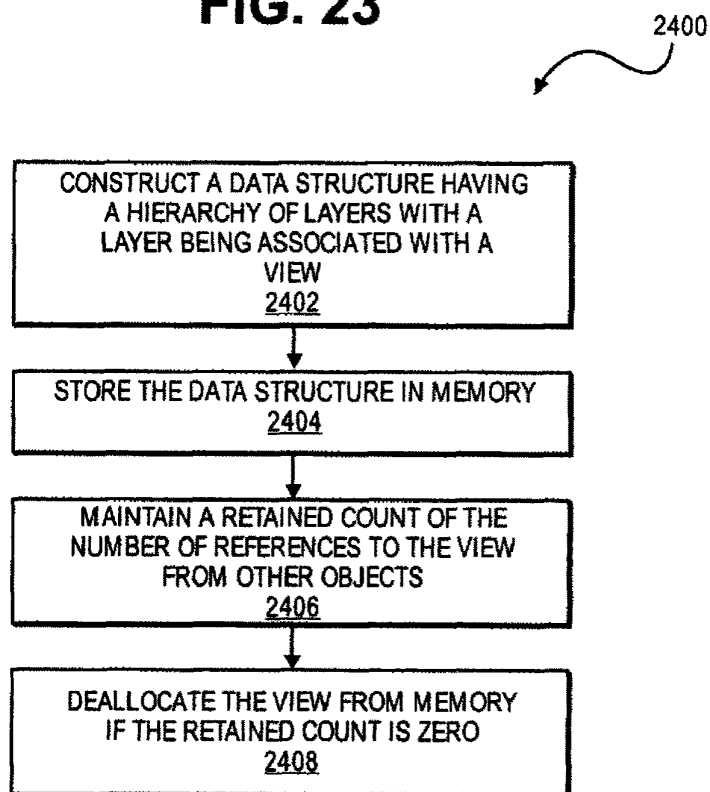

FIG. 22B

**FIG. 23****FIG. 24**