

## EXHIBIT 2.09

## Electronic Acknowledgement Receipt

<b>EFS ID:</b>	3642591
<b>Application Number:</b>	11956969
<b>International Application Number:</b>	
<b>Confirmation Number:</b>	8460
<b>Title of Invention:</b>	List Scrolling and Document Translation, Scaling, and Rotation on a Touch-Screen Display
<b>First Named Inventor/Applicant Name:</b>	Bas Ording
<b>Customer Number:</b>	61725
<b>Filer:</b>	Robert B. Beyers./Deborah Carney
<b>Filer Authorized By:</b>	Robert B. Beyers.
<b>Attorney Docket Number:</b>	P4304US1/63266-5054US
<b>Receipt Date:</b>	18-JUL-2008
<b>Filing Date:</b>	14-DEC-2007
<b>Time Stamp:</b>	16:13:31
<b>Application Type:</b>	Utility under 35 USC 111(a)

### Payment information:

Submitted with Payment	no
------------------------	----

### File Listing:

Document Number	Document Description	File Name	File Size(Bytes) /Message Digest	Multi Part /.zip	Pages (if appl.)
1	Information Disclosure Statement (IDS) Filed	63266-5054US_IDS.pdf	353768 <small>91d484a3c17e49ffc2a6c3698179f46f98d2c6d1</small>	no	7

### Warnings:

### Information:

This is not an USPTO supplied IDS fillable form					
2	Foreign Reference	EP_0635779.pdf	2903584 d7ee8f47ad8910c487409bd897655642b83c5fb7	no	46
<b>Warnings:</b>					
<b>Information:</b>					
3	Foreign Reference	EP_0880091.pdf	514717 2c3729793c1881e53b2fe86d28aa7bf2efe300de	no	10
<b>Warnings:</b>					
<b>Information:</b>					
4	Foreign Reference	WO0201338.pdf	532640 834e9ce4e62942c92743aefac71eaa8cb68c5961	no	19
<b>Warnings:</b>					
<b>Information:</b>					
5	Foreign Reference	WO03060622.pdf	369725 93f24c8057f03abcb272b62160d11ae3a828fd	no	18
<b>Warnings:</b>					
<b>Information:</b>					
6	Foreign Reference	WO2006020305.pdf	3664165 9fe57df2d39bf78f7b635b290828924ff36e726f	no	88
<b>Warnings:</b>					
<b>Information:</b>					
7	NPL Documents	ScrollControl.pdf	220530 5e24d6047f896d46f511aa368167c035cd0f1192	no	6
<b>Warnings:</b>					
<b>Information:</b>					
8	NPL Documents	Tidwell.pdf	1522215 d16baafb22e966f09de1292655550bbced6bd25	no	5
<b>Warnings:</b>					
<b>Information:</b>					
9	NPL Documents	Invitation08_050292.pdf	171313 0d1ddff0dd1c2ff0221344310297578cef d5ab11	no	4
<b>Warnings:</b>					
<b>Information:</b>					
<b>Total Files Size (in bytes):</b>			10252657		

**This Acknowledgement Receipt evidences receipt on the noted date by the USPTO of the indicated documents, characterized by the applicant, and including page counts, where applicable. It serves as evidence of receipt similar to a Post Card, as described in MPEP 503.**

**New Applications Under 35 U.S.C. 111**

**If a new application is being filed and the application includes the necessary components for a filing date (see 37 CFR 1.53(b)-(d) and MPEP 506), a Filing Receipt (37 CFR 1.54) will be issued in due course and the date shown on this Acknowledgement Receipt will establish the filing date of the application.**

**National Stage of an International Application under 35 U.S.C. 371**

**If a timely submission to enter the national stage of an international application is compliant with the conditions of 35 U.S.C. 371 and other applicable requirements a Form PCT/DO/EO/903 indicating acceptance of the application as a national stage submission under 35 U.S.C. 371 will be issued in addition to the Filing Receipt, in due course.**

**New International Application Filed with the USPTO as a Receiving Office**

**If a new international application is being filed and the international application includes the necessary components for an international filing date (see PCT Article 11 and MPEP 1810), a Notification of the International Application Number and of the International Filing Date (Form PCT/RO/105) will be issued in due course, subject to prescriptions concerning national security, and the date shown on this Acknowledgement Receipt will establish the international filing date of the application.**

**IN THE UNITED STATES PATENT AND TRADEMARK OFFICE**

Application of:	Bas Ording	Confirmation No.:	8460
Serial No.:	11/956,969	Art Unit:	2174
Filed:	December 14, 2007	Examiner:	Pesin, Boris M.
For:	<i>List Scrolling and Document Translation, Scaling, and Rotation on a Touch-Screen Display</i>	Attorney Docket No.:	P4304US1/63266-5054US

**INFORMATION DISCLOSURE STATEMENT**

Commissioner for Patents  
P.O. Box 1450  
Alexandria, VA 22313-1450

Sir:

In accordance with the duty of disclosure provisions of 37 C.F.R. §1.56, there is hereby provided certain information which the Examiner may consider material to the examination of the subject U.S. patent application. It is requested that the Examiner make this information of record if it is deemed material to the examination of the application.

1. Enclosures accompanying this Information Disclosure Statement are:
  - 1a.  A list of all patents, publications, applications, or other information submitted for consideration by the office.
  - 1b. A legible copy of :
    - Each foreign patent;
    - Each publication or that portion which caused it to be listed on the PTO-1449;
    - For each cited pending U.S. application, the application specification including the claims, and any drawing of the application, or portion of the application which caused it to be listed on the PTO-1449 including any claims directed to that portion;
    - all other information or portion which caused it to be listed on the PTO-1449.
  - 1c.  An English language copy of search report(s) from a counterpart foreign application or PCT International Search Report.
  - 1d.  Explanations of relevancy (ATTACHMENT 1(d), hereto) or English language abstracts of the non-English language publications.

2.  This Information Disclosure Statement is filed under 37 C.F.R. §1.97(b):
- Within three months of the filing date of a national application other than a continued prosecution application under §1.53(d);
  - Within three months of the date of entry of the national stage as set forth in §1.491 in an international application;
  - Before the mailing of the first Office action on the merits;
  - Before the mailing of a first Office action after the filing of a request for continued examination under §1.114.

3.  This Information Disclosure Statement is filed under 37 C.F.R. §1.97(c) after the period specified in 37 C.F.R. §1.97(b), but before the mailing date of any of a final action under 37 C.F.R. §1.113, a notice of allowance under 37 C.F.R. §1.311 or an action that otherwise closes prosecution in the application.

*(Check either Item 3a or 3b)*

- 3a.  The Certification Statement in Item 5 below is applicable. Accordingly, no fee is required.
- 3b.  The \$180.00 fee set forth in 37 C.F.R. §1.17(p) in accordance with 37 C.F.R. §1.97(c) is:
- enclosed
  - to be charged to Morgan, Lewis & Bockius LLP Deposit Account No. 50-0310 (order no. \_\_\_\_\_).

*(Item 3b to be checked if any reference known for more than 3 months)*

4.  This Information Disclosure Statement is filed under 37 C.F.R. §1.97(d) after the period specified in 37 C.F.R. §1.97(c), but on or before the date of payment of the issue fee.

*(Check either Item 4a or 4b)*

- 4a.  The Certification Statement in Item 5 below is applicable.
- 4b.  The \$180.00 fee set forth in 37 C.F.R. §1.17(p) is:
- enclosed.
  - to be charged to Morgan, Lewis & Bockius LLP Deposit Account No. 50-0310 (order no. \_\_\_\_\_).

5.  Certification Statement (applicable if Item 3a or Item 4a is checked)

*(Check either Item 5a, 5b or 5c)*

- 5a.  In accordance with 37 C.F.R. §1.97(e)(1), it is certified that each item of information contained in this Information Disclosure Statement was first cited in a communication from a foreign patent office in a counterpart foreign application not more than three months prior to the filing of this Information Disclosure Statement.
- 5b.  In accordance with 37 C.F.R. §1.97(e)(2), it is certified that no item of information contained in the information disclosure statement was cited in a communication from a foreign patent office in a counterpart foreign application,

and, to the knowledge of the person signing the certification after making reasonable inquiry, no item of information contained in the information disclosure statement was known to any individual designated in § 1.56(c) more than three months prior to the filing of the information disclosure statement.

- 5c.  Pursuant to 37 C.F.R. §1.704(d), each item of information contained in this information disclosure statement was cited in a communication from a foreign patent office in a counterpart application, and the communication was not **received** by any individual designated in 37 C.F.R. §1.56(c) more than thirty days prior to the filing of this information disclosure statement.
6.  Copies of each cited U.S. patent and each U.S. patent application publication are not enclosed pursuant to the USPTO OG Notice dated 05 August 2003 waiving the requirement under 37 C.F.R. 1.98(a)(2)(i) for U.S. patent applications filed after June 30, 2003.
7.  This application is a continuation application under 37 C.F.R. §1.53(b) or (d).  
*(Check appropriate Items 7a, 7b and/or 7c)*
- 7a.  A Petition to Withdraw from issue under 37 C.F.R. §1.313(b)(5) is concurrently filed herewith.
- 7b.  Copies of publications listed on Form PTO-1449 from prior application Serial No. \_\_\_\_\_, filed on \_\_\_\_\_, of which this application claims priority under 35 U.S.C. §120, are not being submitted pursuant to 37 C.F.R. §1.98(d).
- 7c.  Copies of the publications listed on Form PTO-1449 were not previously cited in prior application Serial No. \_\_\_\_\_, filed on \_\_\_\_\_, and are provided herewith.
8.  This is a Supplemental Information Disclosure Statement. (Check Item 8a)
- 8a.  This Supplemental Information Disclosure Statement under 37 C.F.R. §1.97(f) supplements the Information Disclosure Statement filed on \_\_\_\_\_. A bona fide attempt was made to comply with 37 C.F.R. §1.98, but inadvertent omissions were made. These omissions have been corrected herein. Accordingly, additional time is requested so that this Supplemental Information Disclosure Statement can be considered as if properly filed on \_\_\_\_\_.
9.  In accordance with 37 C.F.R. §1.98, a concise explanation of what is presently understood to be the relevance of each non-English language publication is:  
*( Check Item 9a, 9b, or 9c)*
- 9a.  satisfied because all non-English language publications were cited on the enclosed English language copy of the PCT International Search Report or the search report from a counterpart foreign application indicating the degree of relevance found by the foreign office.
- 9b.  set forth in the application.
- 9c.  enclosed as an attachment hereto.
10.  The Commissioner is authorized to charge any additional fee required or credit any overpayment for this Information Disclosure Statement and/or Petition to Morgan, Lewis & Bockius LLP Deposit Account No. 50-0310 (order no. 63266-5054-US).

11.  No admission is made that the information cited in this Statement is, or is considered to be, material to patentability nor a representation that a search has been made (other than a search report of a foreign counterpart application or PCT International Search Report if submitted herewith). 37 C.F.R. §§1.97(g) and (h).

Respectfully submitted,

Date: July 18, 2008

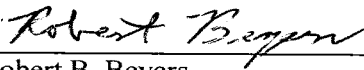
  
Robert B. Beyers 46,552  
MORGAN, LEWIS & BOCKIUS LLP (Reg. No.)  
2 Palo Alto Square  
3000 El Camino Real, Suite 700  
Palo Alto, CA 94306  
(650) 843-4000



<b>Examiner-Initiated Interview Summary</b>	<b>Application No.</b> 11/956,969	<b>Applicant(s)</b> ORDING, BAS	
	<b>Examiner</b> BORIS PESIN	<b>Art Unit</b> 2174	

**All Participants:**

(1) BORIS PESIN.

(2) Robert Beyers.

**Status of Application:** \_\_\_\_\_

(3) Cindy Wheeler.

(4) \_\_\_\_\_.

**Date of Interview:** 4 August 2008

**Time:** 1:00

**Type of Interview:**

- Telephonic  
 Video Conference  
 Personal (Copy given to:  Applicant  Applicant's representative)

Exhibit Shown or Demonstrated:  Yes  No  
 If Yes, provide a brief description:

**Part I.**

Rejection(s) discussed:

Claims discussed:

*All*

Prior art documents discussed:

*Photo Mesa, and Jeeger*

**Part II.**

**SUBSTANCE OF INTERVIEW DESCRIBING THE GENERAL NATURE OF WHAT WAS DISCUSSED:**

*See Continuation Sheet*

**Part III.**

- It is not necessary for applicant to provide a separate record of the substance of the interview, since the interview directly resulted in the allowance of the application. The examiner will provide a written summary of the substance of the interview in the Notice of Allowability.
- It is not necessary for applicant to provide a separate record of the substance of the interview, since the interview did not result in resolution of all issues. A brief summary by the examiner appears in Part II above.

/Boris Pesin/  
 Examiner, Art Unit 2174

(Applicant/Applicant's Representative Signature – if appropriate)

Continuation of Substance of Interview including description of the general nature of what was discussed: The Examiner and the Applicant discussed the proposed amended claims. The Examiner agreed that the proposed amended claims were patentable over the cited art. The Examiner further agreed to make the proposed amended claim via an Examiner's amendment.

<b>INFORMATION DISCLOSURE CITATION</b>  PTO-1449				<i>Complete If Known</i>		
				<b>Application Number</b>	11/956,969	
				<b>Filing Date</b>	December 14, 2007	
				<b>First Named Inventor</b>	Bas Ording	
				<b>Art Unit</b>	2174	
<b>Examiner Name</b>	Pesin, Boris M.		<b>Attorney Docket No.</b>	P4304US1/63266-5054US		
Sheet	1	of	1			

U.S. PATENT DOCUMENTS							
Examiner Initials	Cite No.	Document Number	Publication Date MM-DD-YYYY	Name of Patentee or Applicant of Cited Document	Class	Subclass	Filing Date if Appropriate
		Number - Kind Code <sup>1</sup>					
		2003/0184525	10-02-2003	Tsai	345	173	
		2004/0155888	08-12-2004	Padgitt et al.	345	619	
		2005/0145807	07-07-2005	Lapstun et al.	250	566	
		2006/0025218	02-02-2006	Hotta	463	37	

FOREIGN PATENT DOCUMENTS								
Examiner Initials	Cite No.	Foreign Patent Document	Publication Date MM-DD-YYYY	Name of Patentee or Applicant of Cited Document	Class	Subclass	Translation	
		Country Code <sup>2</sup> - Number <sup>3</sup> - Kind Code <sup>4</sup> (if known)					Yes	No
		EP 0 701 220 A	03-13-1996	Adobe Systems Inc.	G06F	17/21		
		WO 05/052773 A2	06-09-2005	Nokia Corporation	G06F	3/00		
		WO 2006/003591 A	01-12-2006	Konin-Klijke Philips Electronics, N.V.	G06F	3/033		

OTHER NON PATENT LITERATURE DOCUMENTS		
Examiner Initials	Cite No.	Include name of the author (in CAPITAL LETTERS), title of the article (when appropriate), title of the item (book, magazine, journal, serial, symposium, catalog, etc.), date, page(s), volume-issue number(s), publisher, city and/or country where published
		International Search Report and Written Opinion for International Application No. PCT/US2008/050292, mailed September 19, 2008.

<b>Examiner Signature</b>	DB2/20858183.1	<b>Date Considered</b>	
---------------------------	----------------	------------------------	--

\*EXAMINER: Initial if reference considered, whether or not citation is in conformance with MPEP 609. Draw line through citation if not in conformance and not considered. Include copy of this form with next communication to applicant.  
<sup>1</sup> See Kind Codes of USPTO Patent Documents at [www.uspto.gov](http://www.uspto.gov) or MPEP 901.04. <sup>2</sup> Enter Office that issued the document, by the two-letter code (WIPO Standard ST.3). <sup>3</sup> For Japanese patent documents, the indication of the year of the reign of the Emperor must precede the serial number of the patent document. <sup>4</sup> Kind of document by the appropriate symbols as indicated on the document under WIPO Standard ST. 16 if possible. <sup>5</sup> Applicant is to place a check mark here if English language Translation is attached.  
 Burden Hour Statement: This form is estimated to take 2.0 hours to complete. Time will vary depending upon the needs of the individual case. Any comments on the amount of time you are required to complete this form should be sent to the Chief Information Officer, U.S. Patent and Trademark Office, Washington, DC 20231. DO NOT SEND FEES OR COMPLETED FORMS TO THIS ADDRESS. SEND TO: Assistant Commissioner for Patents, P.O. Box 1450, Alexandria, VA 22313-1450.

## Electronic Acknowledgement Receipt

<b>EFS ID:</b>	4065168
<b>Application Number:</b>	11956969
<b>International Application Number:</b>	
<b>Confirmation Number:</b>	8460
<b>Title of Invention:</b>	List Scrolling and Document Translation, Scaling, and Rotation on a Touch-Screen Display
<b>First Named Inventor/Applicant Name:</b>	Bas Ording
<b>Customer Number:</b>	61725
<b>Filer:</b>	Robert B. Beyers./Deborah Carney
<b>Filer Authorized By:</b>	Robert B. Beyers.
<b>Attorney Docket Number:</b>	P4304US1/63266-5054US
<b>Receipt Date:</b>	06-OCT-2008
<b>Filing Date:</b>	14-DEC-2007
<b>Time Stamp:</b>	15:38:55
<b>Application Type:</b>	Utility under 35 USC 111(a)

### Payment information:

Submitted with Payment	no
------------------------	----

### File Listing:

Document Number	Document Description	File Name	File Size(Bytes)/ Message Digest	Multi Part /.zip	Pages (if appl.)
1	Information Disclosure Statement (IDS) Filed (SB/08)	63266-5054US_IDS.pdf	228720 <small>6c0991124e7a6d61fcc42294eafb9d5a5eaeb1f</small>	no	5

### Warnings:

### Information:

This is not an USPTO supplied IDS fillable form					
2	Foreign Reference	EP0701220.pdf	1651201 c4c7ba241e0cc73a439520bce2805851196542ce	no	33
<b>Warnings:</b>					
<b>Information:</b>					
3	Foreign Reference	WO05052773.pdf	883298 bdd29ff1675d43d98f7dee8a8d6ae1454c467b52	no	27
<b>Warnings:</b>					
<b>Information:</b>					
4	Foreign Reference	WO2006003591.pdf	614035 21fb576f995599996ee77378f45d60d40ba17bfa	no	17
<b>Warnings:</b>					
<b>Information:</b>					
5	NPL Documents	ISRUS08_050292.pdf	1134778 f5e5e7df174638ee6b77e86989801e48d4b62e48	no	25
<b>Warnings:</b>					
<b>Information:</b>					
<b>Total Files Size (in bytes):</b>				451 2032	

**This Acknowledgement Receipt evidences receipt on the noted date by the USPTO of the indicated documents, characterized by the applicant, and including page counts, where applicable. It serves as evidence of receipt similar to a Post Card, as described in MPEP 503.**

**New Applications Under 35 U.S.C. 111**

**If a new application is being filed and the application includes the necessary components for a filing date (see 37 CFR 1.53(b)-(d) and MPEP 506), a Filing Receipt (37 CFR 1.54) will be issued in due course and the date shown on this Acknowledgement Receipt will establish the filing date of the application.**

**National Stage of an International Application under 35 U.S.C. 371**

**If a timely submission to enter the national stage of an international application is compliant with the conditions of 35 U.S.C. 371 and other applicable requirements a Form PCT/DO/EO/903 indicating acceptance of the application as a national stage submission under 35 U.S.C. 371 will be issued in addition to the Filing Receipt, in due course.**

**New International Application Filed with the USPTO as a Receiving Office**

**If a new international application is being filed and the international application includes the necessary components for an international filing date (see PCT Article 11 and MPEP 1810), a Notification of the International Application Number and of the International Filing Date (Form PCT/RO/105) will be issued in due course, subject to prescriptions concerning national security, and the date shown on this Acknowledgement Receipt will establish the international filing date of the application.**

## WO2006003591

Publication Title:

DISCONTINUOUS ZOOM

Abstract:

Abstract of WO2006003591

In a method and apparatus for zooming on a display device, instead of zooming just on the pixels in the display, zooming is effected on discernable objects comprising pixels in the displayed image. Initially, spaces between the discernable objects is reduced, and then the discernable objects are increased in size until the objects reach a minimum surface area, which is the minimum size, based on the size and resolution of the display, recognizable by a user. Zooming is then suspended until the user selects one of the objects. Zooming is then allowed to continue on only the selected object until the maximum zooming factor is reached.

Data supplied from the esp@cenet database - Worldwide

-----  
Courtesy of <http://v3.espacenet.com>

(19) World Intellectual Property Organization  
International Bureau



(43) International Publication Date  
12 January 2006 (12.01.2006)

PCT

(10) International Publication Number  
**WO 2006/003591 A2**

- (51) International Patent Classification<sup>7</sup>: **G06F 3/033**
- (21) International Application Number: PCT/IB2005/052108
- (22) International Filing Date: 24 June 2005 (24.06.2005)
- (25) Filing Language: English
- (26) Publication Language: English
- (30) Priority Data:
  - 60/583,968 29 June 2004 (29.06.2004) US
  - 60/646,087 21 January 2005 (21.01.2005) US
- (71) Applicant (for all designated States except US): **KONINKLIJKE PHILIPS ELECTRONICS, N.V.** [NL/NL]; Groenewoudseweg 1, NL-5621 BA Eindhoven (NL).
- (71) Applicant (for AE only): **U.S. PHILIPS CORPORATION** [US/US]; 1251 Avenue of the Americas, New York, NY 10020 (US).
- (72) Inventors; and
- (75) Inventors/Applicants (for US only): **HOLLEMANS,**

Gerard [NL/NL]; Groenewoudseweg 1, NL-5621 BA Eindhoven (NL). **KLEINHOUT, Huib V.** [NL/NL]; Groenewoudseweg 1, NL-5621 BA Eindhoven (NL). **BUIL, Vincent P.** [NL/NL]; Groenewoudseweg 1, NL-5621 BA Eindhoven (NL).

- (74) Common Representative: **KONINKLIJKE PHILIPS ELECTRONICS, N.V.**; c/o Edward W. Goodjman, P.O. Box 3001, Briarcliff Manor, NY 10510-8001 (US).
- (81) Designated States (unless otherwise indicated, for every kind of national protection available): AE, AG, AL, AM, AT, AU, AZ, BA, BB, BG, BR, BW, BY, BZ, CA, CH, CN, CO, CR, CU, CZ, DE, DK, DM, DZ, EC, EE, EG, ES, FI, GB, GD, GE, GH, GM, HR, HU, ID, IL, IN, IS, JP, KE, KG, KM, KP, KR, KZ, LC, LK, LR, LS, LT, LU, LV, MA, MD, MG, MK, MN, MW, MX, MZ, NA, NG, NI, NO, NZ, OM, PG, PH, PL, PT, RO, RU, SC, SD, SE, SG, SK, SL, SM, SY, TJ, TM, TN, TR, TT, TZ, UA, UG, US, UZ, VC, VN, YU, ZA, ZM, ZW.
- (84) Designated States (unless otherwise indicated, for every kind of regional protection available): ARIPO (BW, GH,

[Continued on next page]

(54) Title: DISCONTINUOUS ZOOM

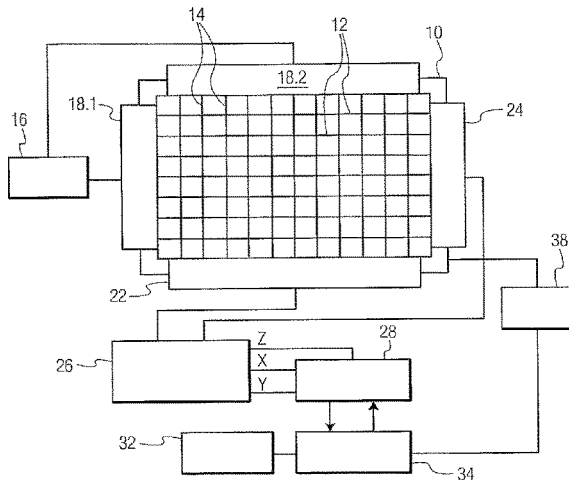

A

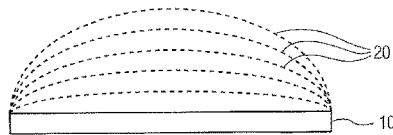

B

(57) Abstract: In a method and apparatus for zooming on a display device, instead of zooming just on the pixels in the display, zooming is effected on discernable objects comprising pixels in the displayed image. Initially, spaces between the discernable objects is reduced, and then the discernable objects are increased in size until the objects reach a minimum surface area, which is the minimum size, based on the size and resolution of the display, recognizable by a user. Zooming is then suspended until the user selects one of the objects. Zooming is then allowed to continue on only the selected object until the maximum zooming factor is reached.

WO 2006/003591 A2



GM, KE, LS, MW, MZ, NA, SD, SL, SZ, TZ, UG, ZM, ZW), Eurasian (AM, AZ, BY, KG, KZ, MD, RU, TJ, TM), European (AT, BE, BG, CH, CY, CZ, DE, DK, EE, ES, FI, FR, GB, GR, HU, IE, IS, IT, LT, LU, MC, NL, PL, PT, RO, SE, SI, SK, TR), OAPI (BF, BJ, CF, CG, CI, CM, GA, GN, GQ, GW, ML, MR, NE, SN, TD, TG).

**Declarations under Rule 4.17:**

- as to applicant's entitlement to apply for and be granted a patent (Rule 4.17(ii)) for the following designations AE, AG, AL, AM, AT, AU, AZ, BA, BB, BG, BR, BW, BY, BZ, CA, CH, CN, CO, CR, CU, CZ, DE, DK, DM, DZ, EC, EE, EG, ES, FI, GB, GD, GE, GH, GM, HR, HU, ID, IL, IN, IS, JP, KE, KG, KM, KP, KR, KZ, LC, LK, LR, LS, LT, LU, LV, MA, MD, MG, MK, MN, MW, MX, MZ, NA, NG, NI, NO, NZ, OM, PG, PH, PL, PT, RO, RU, SC, SD, SE, SG, SK, SL, SM, SY, TJ, TM, TN, TR, TT, TZ, UA, UG, UZ, VC, VN, YU, ZA, ZM, ZW, ARIPO patent (BW, GH, GM, KE, LS, MW,

MZ, NA, SD, SL, SZ, TZ, UG, ZM, ZW), Eurasian patent (AM, AZ, BY, KG, KZ, MD, RU, TJ, TM), European patent (AT, BE, BG, CH, CY, CZ, DE, DK, EE, ES, FI, FR, GB, GR, HU, IE, IS, IT, LT, LU, MC, NL, PL, PT, RO, SE, SI, SK, TR), OAPI patent (BF, BJ, CF, CG, CI, CM, GA, GN, GQ, GW, ML, MR, NE, SN, TD, TG)

- as to the applicant's entitlement to claim the priority of the earlier application (Rule 4.17(iii)) for all designations
- as to the applicant's entitlement to claim the priority of the earlier application (Rule 4.17(iii)) for all designations

**Published:**

- without international search report and to be republished upon receipt of that report

For two-letter codes and other abbreviations, refer to the "Guidance Notes on Codes and Abbreviations" appearing at the beginning of each regular issue of the PCT Gazette.



## DISCONTINUOUS ZOOM

## Field Of The Invention

The subject invention relates to zooming, and more particularly, to zooming an image signal containing discernable objects on a display device.

## 5 Description Of The Related Art

Zooming is usually applied to enable a user to more easily see the details of items that are presented on a display screen of a display device. It is known from psychology that visual objects in close proximity of the object of attention can be ignored by the brain of a user, but do affect the processing of the object of attention negatively, i.e., they can be partly  
10 ignored, but remain distracting. Most zooming functions do not take this into consideration, and zoom continuously in such a way that any displayed pixel is zoomed in. This leads to enlargement of portions of the image having irrelevant information, e.g., spaces between objects on the display screen as well as the objects themselves.

However, in some video images, objects in the image can be discerned but the  
15 prior art zooming methods ignore these discernable objects and proceed to zoom on all of the pixels in the display.

It is an object of the invention, when presented with an image signal having discernable objects, to only zoom on the pixels in the discernable objects.

This object is achieved in a method for zooming a video image on a display  
20 device, said video image being discernable in a plurality of objects, and said display device having a minimum surface area for objects, said method comprising the steps of displaying a video image on a display screen of a display device, said video image having discernable objects each comprising a plurality of pixels; discerning the objects in said video image; zooming said video image by reducing the area of any spaces in the video image not included  
25 in said discernable objects, and increasing the sizes of said discerned objects until said discerned objects have said minimum surface area; discontinuing said zooming until a user selects one of said discerned objects; detecting the user's selection out of said discerned objects; and zooming only on the selected discerned object.

The above object is also achieved in an apparatus for zooming a video image on

a display device, said video image being discernable in a plurality of objects, and said display device having a minimum surface area for objects, said apparatus comprising a video image processor for displaying a video image on a display screen of a display device, said video image having discernable objects each comprising a plurality of pixels; means for discerning  
5 the objects in said video image; means for zooming said video image by reducing the area of any spaces in the video image not included in said discernable objects, and increasing the sizes of said discerned objects until said discerned objects have said minimum surface area, and for generating a status signal; means for discontinuing said zooming upon receipt of said status signal; means for detecting the user's selection out of said discerned objects; and means for  
10 continuing zooming only on the selected discerned object.

Applicants have found that instead of zooming on all displayed pixels, zooming may be applied to only the pixels in visual objects, such as buttons, as is done in some applications. So far, this has been used to enlarge elements of user interfaces that are then more easily accessible for users to operate on. Applicants propose to apply the same principle to  
15 displayed text that is encoded in XML, or a derivative, such as HTML.

XML, and HTML, pages can be structured such that objects of text, e.g., the main body, an advertisement banner, the navigation section, can be identified. Even if these pages are not purposely structured so that these elements can be recognized, it is possible to do so with simple analysis of the document, e.g., extracting the tables from an HTML page.

20 Once the page can be divided into objects as well as pixels (of the page and of the objects), an input of the user on the zoom factor (i.e., a user request the zoom in or out) may now be translated into changes in what is being displayed. When the whole page fits the screen such that the individual objects are meaningfully selectable, i.e., the user is able to see what he/she is selecting, the user is then able to select the desired object, and zooming is  
25 continued based on the selected object.

Ordinarily, zooming is usually provided since the screen is too small for a user to operate on the individual elements without zooming, while an overview of the image is meaningful to determine a general direction of panning and/or zooming. For these cases, the discontinuous zooming of the subject invention is helpful. The zooming first works on the  
30 whole page up to a point where the user can select an object to zoom in, at which point zooming stops. Once the user has selected an object of interest, other objects are left out from

the display and the zooming works on the selected object.

The zoom factor must be determined at which to require the user to make a selection. Since this depends on the size of the page and the absolute and relative sizes of the objects on the page, the zoom factor at which the user has to choose an object cannot be a fixed  
5 factor for all pages. For a given screen size, the average minimum surface area can be derived for an object to be recognized. Thus, in the zooming processing, all of the “white space”, i.e., non-object space, is reduced, then the zooming process continues by zooming the objects until all objects that are being displayed have the minimum surface area as determined. At this point, zooming is suspended pending the user selecting on object to zoom in on.

10 In an embodiment of the method and apparatus of the invention, the increasing in size of each of the discerned objects stops when the size of the relevant discerned object reaches said minimum surface area. If the sizes of the displayed objects are too different, one object could fill the screen almost completely before another object has the minimum required surface area. As such, the subject invention stops increasing the size of an object when that  
15 object reaches the minimum surface area. This allows sufficient space for other smaller objects to be zoomed in order to reach the minimum surface area.

In another embodiment of the method and apparatus of the invention, the object selected by the user is highlighted. This provides a feedback to the user as to which object has been selected.

20 With the above and additional objects and advantages in mind as will hereinafter appear, the invention will be described with reference to the accompanying drawings, in which:

Fig. 1A is a block diagram of a display device having a capacitive sensor array incorporated therein;

25 Fig. 1B is a diagram showing the detection lines of the sensor array of Fig. 1A;

Fig. 2 is a diagram showing the detection zone extending from the surface of the display screen;

Figs. 3A-3D show various stages of zooming of objects on the display screen of the display device;

30 Fig. 4 shows a graph of the zoom factor versus the distance from the display screen; and

Fig. 5 shows an illustration of a portable video device in which zooming is controlled by keys.

The subject invention makes use of a 3-D display, that is, a display that is capable of detecting the horizontal and vertical position of a pointer, stylus or a user's finger with respect to the surface of the display screen, as well as the distance of the pointer, stylus or user's finger from the surface of the display screen. There are various known types of 3-D displays using, for example, infrared sensing, capacitance sensing, etc. One type of a 3-D display is disclosed in U.S. Patent Application Publication No. US2002/0000977 A1, which is incorporated herein by reference.

As shown in Fig. 1A, a display screen 10 has superimposed thereon a grid of electrically conductive transparent conductors in which the horizontal conductors 12 are electrically isolated from the vertical conductors 14. A voltage source 16 connected to connection blocks 18.1 and 18.2 applies a voltage differential across the horizontal and vertical conductors 12 and 14. This arrangement develops a detection field 20 extending away from the surface of the display screen 10 as shown in Fig. 1B, with the horizontal and vertical conductors 12 and 14 acting as plates of a capacitor.

When, for example, a user's finger enters the detection field 20, the capacitance between the conductors 12 and 14 is affected and is detected by X-axis detector 22, connected to the vertical conductors 14 and the Y-axis detector 24, connected to the horizontal conductors 12. A detector signal processor 26 receives the output signals from the X and Y detectors 22 and 24 and generates X, Y coordinate signals and a Z distance signal. The X and Y coordinate signals and the Z distance signal are applied to a zoom controller 28.

In addition, as shown in Fig. 1A, an image signal source 32 supplies an image signal to an image signal processor 34, which also receives a zoom control signal from the zoom controller 28. The output signals from the image signal processor 34 is supplied to a display controller 38 which then applies video signals to the display screen 10.

As shown in Fig. 2, the zoom controller 28 establishes a zone A extending in the Z direction (dual-headed arrow 40) from the surface of the display screen 10. The zone A denotes a zone in which, when the user's finger 42 passes a threshold distance 44, the user's finger 42 is detected and zooming is initiated.

Fig. 3A shows a display screen 10 in which a video image contains discernable

objects 50, 52, 54 and 56 of varying sizes separated by spaces 58. These objects are detected in the image signal processor 34. Once the zooming process commences (e.g., the user moves his/her finger 42 towards the display screen 10 past the threshold 44), the image signal processor 34, in response to zoom control signals from the zoom controller, reduces the size of the spaces 58 between the objects 50-56, as shown in Fig. 3B. Then, the image signal processor 34 increases the sizes (zooms) the objects 50-56 until they reach a minimum surface area (see Fig. 3C). This minimum surface area is predetermined by the size and resolution of the display screen 10 and represents a minimum size of an object at which the object may be discerned by a viewer. At this point, the image signal processor 34 signals the zoom controller 28 and zooming process is suspended (i.e., further movement of the user's finger toward the display screen 10 is ignored) until the user selects one of the objects. With the 3-D touch display, this may involve the user moving his/her finger in the X/Y direction and selecting the object by, for example, slightly retracting his/her finger. As shown in Fig. 3C, the image signal processor 34 may highlight the selected object 54. At this point, the zooming process is allowed to continue with the selected object 54 increasing in size while the unselected objects 50, 52 and 56 drop off the screen.

Fig. 4 shows a graph illustrating the zooming process in which the X axis is the distance from the display screen 10 and the Y axis is the zoom factor. Until the user's finger 42 passes the threshold 44, the zoom factor curve 60 assumes a predetermined minimum value. Once the user's finger 42 passes the threshold 44, zooming factor curve 60 begins to increase with the reduction in the spaces followed by the increase of the surface areas of the objects. At distance 62, when all of the objects have reached the minimum surface area, changes in the zooming factor curve 60 is suspended while allowing the user to select one of the objects. At that point as indicated by distance 64, zooming continues on the selected object up to the maximum zoom factor at distance 66.

In the case where the objects 50-56 greatly vary in size, during the process of increasing the size of the objects, the larger object(s) may reach and surpass the minimum surface area well before the smaller object(s). In order to prevent these larger objects from dominating the display screen 10 prior to the smaller objects attaining the minimum surface area, as soon as each object achieves the minimum surface area, zooming on that particular object is suspended while zooming continues on the smaller object(s).

While the subject invention has been described as embodied in a 3-D touch display device, this is not necessarily the case. A portable display device 70 is shown in Fig. 5 and has a display screen 72. The portable display device 70 has a plurality of keys 74 enabling a user to control the various functions. Among the keys 74 are a “-“ key 76 and a “+” key 78 which may be used to control zooming. In particular, zooming commences when the user presses and holds down the “+” key 78. Again, first the spaces are reduced and then the surface areas of the objects are increased until the objects have the minimum surface area. Zooming is then suspended even though the user may continue to press the “+” key 78. Using the keys 74, the user selects one of the objects, and then when the user presses and holds down the “+” key, zooming is continued on the selected object until the zooming reaches the maximum zooming factor.

Although this invention has been described with reference to particular embodiments, it will be appreciated that many variations will be resorted to without departing from the spirit and scope of this invention as set forth in the appended claims. The specification and drawings are accordingly to be regarded in an illustrative manner and are not intended to limit the scope of the appended claims.

In interpreting the appended claims, it should be understood that:

- a) the word "comprising" does not exclude the presence of other elements or acts than those listed in a given claim;
- b) the word "a" or "an" preceding an element does not exclude the presence of a plurality of such elements;
- c) any reference signs in the claims do not limit their scope;
- d) several "means" may be represented by the same item or hardware or software implemented structure or function;
- e) any of the disclosed elements may be comprised of hardware portions (e.g., including discrete and integrated electronic circuitry), software portions (e.g., computer programming), and any combination thereof;
- f) hardware portions may be comprised of one or both of analog and digital portions;
- g) any of the disclosed devices or portions thereof may be combined together or separated into further portions unless specifically stated otherwise; and

h) no specific sequence of acts is intended to be required unless specifically indicated.

## CLAIMS:

1. A method for zooming a video image on a display device, said video image being discernable in a plurality of objects, and said display device having a minimum surface area for objects, said method comprising the steps of:
- 5 displaying (32, 34, 38) a video image on a display screen (10) of a display device, said video image having discernable objects (50, 52, 54, 56) each comprising a plurality of pixels;
- discerning (34) the objects in said video image;
- 10 zooming (28, 34) said video image by reducing the area of any spaces (58) in the video image not included in said discernable objects (50, 52, 54, 56), and increasing the sizes of said discerned objects (50, 52, 54, 56) until said discerned objects have said minimum surface area;
- discontinuing said zooming until a user selects one (54) of said discerned
- 15 objects (50, 52, 54, 56);
- detecting the user's selection (54) out of said discerned objects; and
- zooming (28, 34) only on the selected discerned object (54).
- 2, The method as claimed in claim 1, wherein after said detecting step, said
- 20 method further comprises the step of:
- removing, from the video image, the discerned objects (50, 52, 56) other than said selected discerned object (54).
3. The method as claimed in claim 1, wherein in said first zooming (28, 34) step,
- 25 the increasing in size of each of the discerned objects (50, 52, 54, 56) stops when the size of the relevant discerned object reaches said minimum surface area.
4. The method as claimed in claim 1, wherein said video image is encoded in XML or HTML object based format.
- 30
5. The method as claimed in claim 1, wherein said detecting step comprises



highlighting a perimeter of said selected discerned object (54).

6. The method as claimed in claim 1, wherein said display device (10) is a 3-D virtual touch display device, and zooming is effected by detecting (22, 24, 26) the position and distance (Z) of a user's finger (42) on and from a display surface (10) of the display device.

7. An apparatus for zooming a video image on a display device, said video image being discernable in a plurality of objects, and said display device having a minimum surface area for objects, said apparatus comprising:

10 a video image processor (34) for displaying a video image on a display screen (10) of a display device, said video image having discernable objects (50, 52, 54, 56) each comprising a plurality of pixels;

means (34) for discerning the objects (50, 52, 54, 56) in said video image;

means (28, 34) for zooming said video image by reducing the area of any spaces

15 (58) in the video image not included in said discernable objects (50, 52, 54, 56), and increasing the sizes of said discerned objects (50, 52, 54, 56) until said discerned objects have said minimum surface area, and for generating a status signal;

means for discontinuing said zooming upon receipt of said status signal;

means for detecting the user's selection (54) out of said discerned objects (50,

20 52, 54, 56); and

means for continuing zooming only on the selected discerned object (54).

8. The apparatus as claimed in claim 7, wherein said apparatus further comprises:

means for removing, from the video image, the discerned objects (50, 52, 56)

25 other than said selected discerned object (54) in response to said detecting means detecting the user's selection..

9. The apparatus as claimed in claim 7, wherein said zooming means (28, 34) increases the size of each of the discerned objects (50, 52, 54, 56) until the size of the relevant

30 discerned object reaches said minimum surface area.

10. The apparatus as claimed in claim 7, wherein said video image is encoded in an XML or HTML object based format.

11. The apparatus as claimed in claim 7, wherein said detecting means highlights  
5 said selected discerned object (54).

12. The method as claimed in claim 7, wherein said display device (10) is a 3-D virtual touch display device, and said zooming means detects (22, 24, 26) the position and distance (Z) of a user's finger (42) on and from a display surface (10) of the display device.

10

1/4

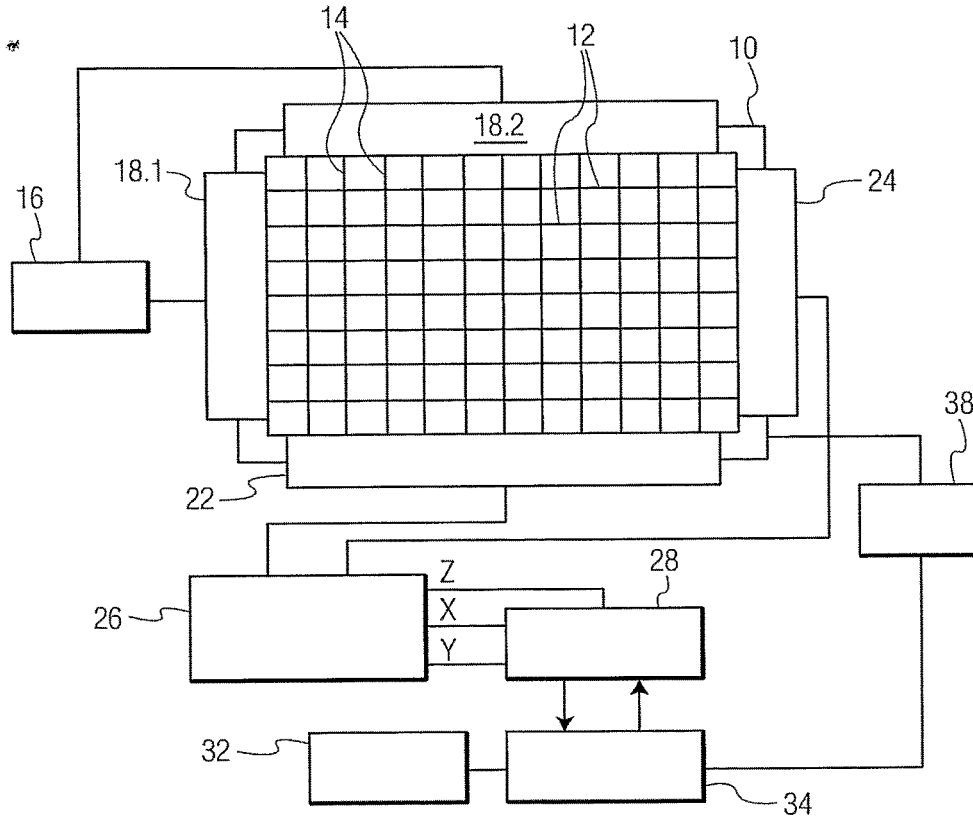

FIG. 1A

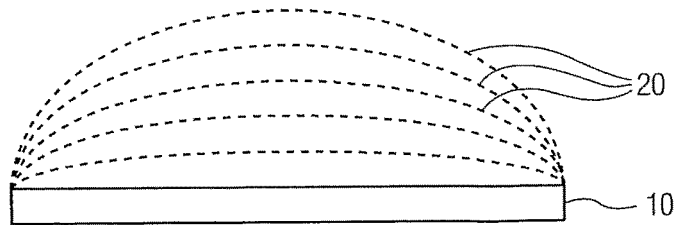

FIG. 1B

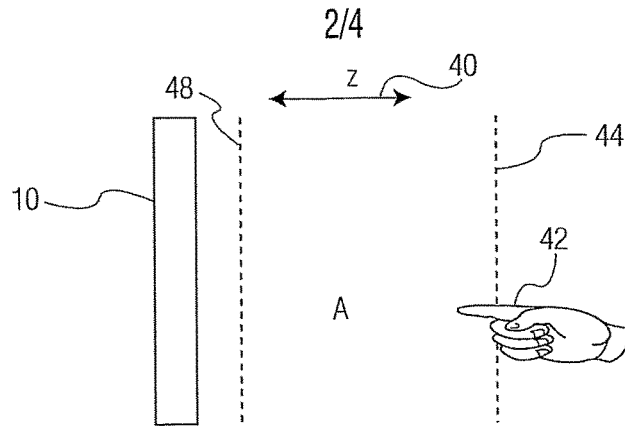

FIG. 2

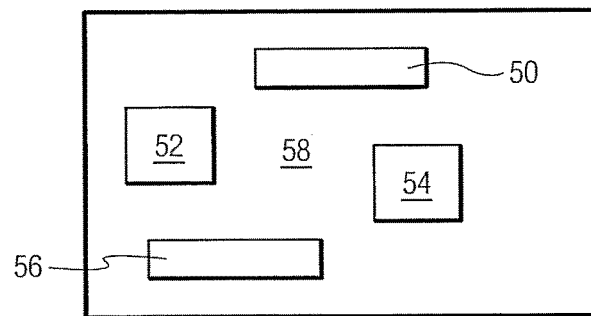

FIG. 3A

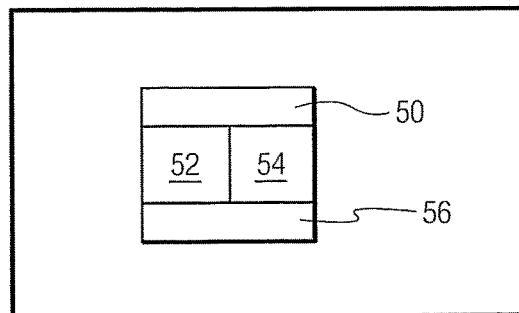

FIG. 3B

3/4

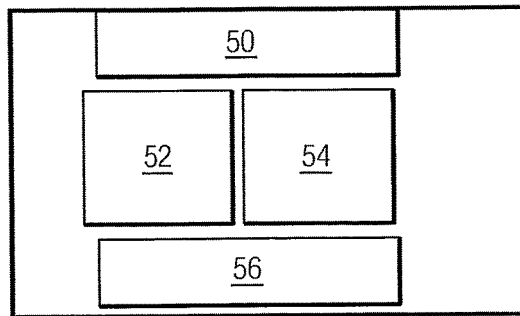

FIG. 3C

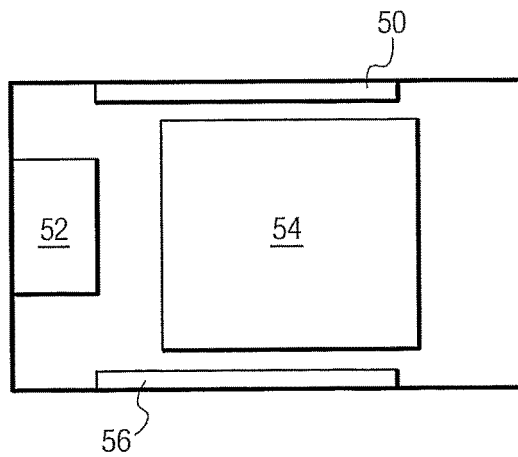

FIG. 3D

4/4

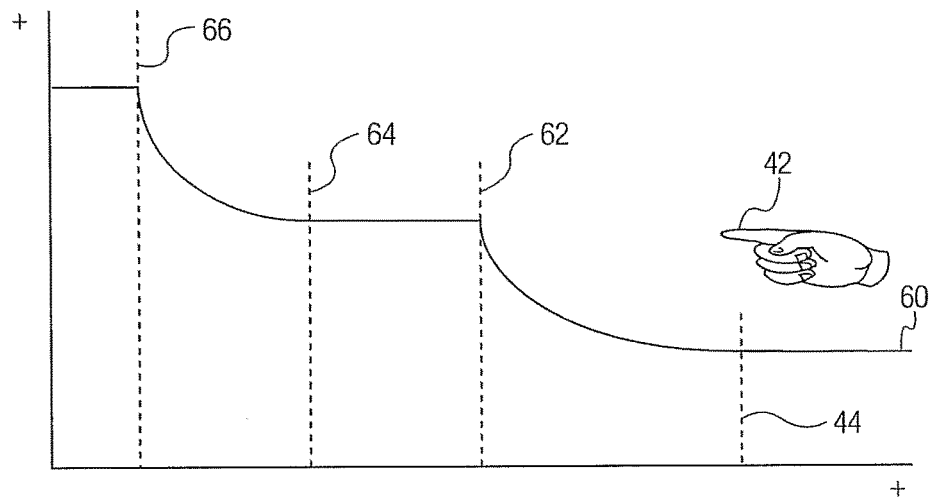

FIG. 4

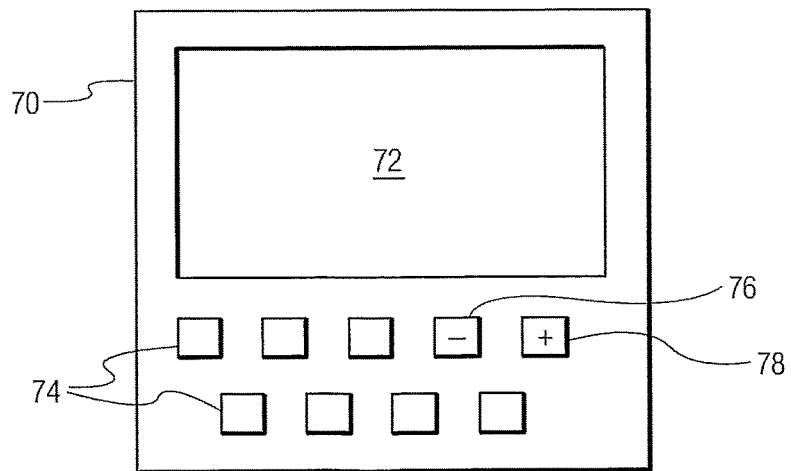

FIG. 5

## EP0701220

Publication Title:

Method and apparatus for viewing electronic documents

Abstract:

Abstract of EP0701220

A reader for displaying an electronic document provided in a predetermined format and allowing articles of the document to be read in the direction of their content information flow. The reader includes a selector to select an article of the document to be read. A displayer displays a first portion of the article in a manner which promotes comfortable viewing, and a navigator permits the display of the next and remaining sequential portions of the article in content flow (or reverse content flow) order. Preferably, the displayer pans and zooms, as necessary, to position the article portion in an article viewing window. A method for viewing electronic documents on a digital computer includes the steps of storing in the memory of the digital computer an electronic document, selecting an article to be displayed on an output device of the digital computer in an article view, displaying at least a portion of the article in the article viewing mode on the output device, and using an input device of the digital computer to cause a display of additional portions of the article to be displayed on the output device in the article viewing mode. These additional portions of the article are determined, at least in part, by predefined article sections and section links of the document so that the thread of the article can be followed in forward and reverse directions.

&lt;MATH&gt;

Data supplied from the esp@cenet database - Worldwide

-----  
Courtesy of <http://v3.espacenet.com>



(12) **EUROPEAN PATENT APPLICATION**

(43) Date of publication:  
**13.03.1996 Bulletin 1996/11**

(51) Int. Cl.<sup>6</sup>: **G06F 17/21**

(21) Application number: **95305286.7**

(22) Date of filing: **28.07.1995**

(84) Designated Contracting States:  
**DE FR GB IT NL SE**

(30) Priority: **12.09.1994 US 304680**

(71) Applicant: **ADOBE SYSTEMS INC.**  
**Mountain View California 94039-7900 (US)**

(72) Inventors:  
 • **Warnock, John E.**  
**Los Altos, CA 94022 (US)**

- **Cohn, Richard J.**  
**Menlo Park, Palo Alto CA. 94025 (US)**
- **McCoy, William H.**  
**San Francisco, CA 94107 (US)**
- **Padgett, Allan P.**  
**Menlo Park, CA 94025 (US)**

(74) Representative: **Wombwell, Francis et al**  
**Potts, Kerr & Co.**  
**15, Hamilton Square**  
**Birkenhead Merseyside L41 6BR (GB)**

(54) **Method and apparatus for viewing electronic documents**

(57) A reader for displaying an electronic document provided in a predetermined format and allowing articles of the document to be read in the direction of their content information flow. The reader includes a selector to select an article of the document to be read. A displayer displays a first portion of the article in a manner which promotes comfortable viewing, and a navigator permits the display of the next and remaining sequential portions of the article in content flow (or reverse content flow) order. Preferably, the displayer pans and zooms, as necessary, to position the article portion in an article viewing window. A method for viewing electronic documents on a digital computer includes the steps of storing in the memory of the digital computer an electronic document, selecting an article to be displayed on an output device of the digital computer in an article view, displaying at least a portion of the article in the article viewing mode on the output device, and using an input device of the digital computer to cause a display of additional portions of the article to be displayed on the output device in the article viewing mode. These additional portions of the article are determined, at least in part, by predefined article sections and section links of the document so that the thread of the article can be followed in forward and reverse directions.

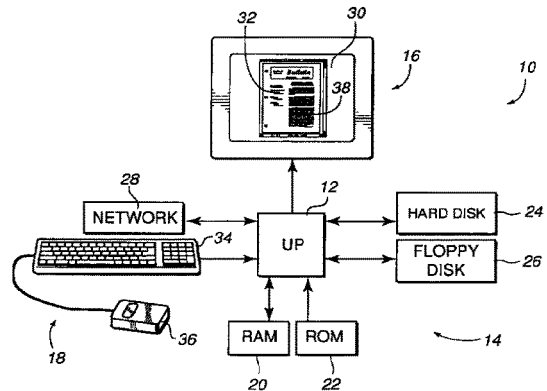

*Fig. 1*

EP 0 701 220 A1



**Description**Background of the Invention5 Field of the Invention

This invention relates generally to the creation, distribution and display of electronic documents and more particularly to the viewing of electronic documents.

10 Description of the Related Art

In this "information era", it has become increasingly common to create, transmit, and display documents in electronic form. Electronic documents have a number of advantages over paper documents including their ease of transmission, their compact storage, and their ability to be edited and/or electronically manipulated.

15 An electronic document typically has information content (such as text, graphics, and pictures) and formatting information which directs how the content is to be displayed. With recent advances in multimedia technology, documents can now also include sound, full motion video, and other multimedia content.

An electronic document is provided by an author, distributor or publisher (hereafter "publisher") who often desires that the document be viewed with the appearance with which it was created. This, however, creates a problem in that 20 electronic documents are typically widely distributed and, therefore, can be viewed on a great variety of hardware and software platforms. For example, the video monitors being used to view the document can vary in size, resolution, etc. Furthermore, the various software platforms such as DOS, Microsoft Windows™, and Macintosh™ all have their own display idiosyncrasies. Also, each user or "reader" of the electronic document will have his or her own personal viewing preferences, which should be accommodated, if possible.

25 A solution proposed for this problem is to provide the content information of an electronic document without a predetermined final format. The content information then can be dynamically formatted (including the creation of line breaks, page breaks, etc.) as it is read by the user. Examples of this solution include the Standard Generalized Mark-Up Language (SGML) and the Office Document Architecture (ODA), both of which emerged through government/military standardization efforts.

30 The aforementioned proposal has never gained wide-spread acceptance. One reason is that formatting complex documents "on the fly" can be slow and can, in practice, produce results that may be aesthetically unpleasant. Another is that when publishers distribute documents, they intend that the documents have a particular appearance for its readers. Solutions which involve dynamic document formatting suffer from the undesired result that the publisher can't control the final appearance of the document. This may be adequate for some content information (such as technical proposals or informal memos), but for the bulk of business and artistic communication, presentation may be a critical factor.

35 A partial solution to this problem is to provide a document in a predetermined format where the appearance of the document as viewed by a reader is as it was intended by the publisher. One such predetermined format is the Portable Document Format™ (PDF™) developed by Adobe Systems, Inc. of Mountain View, California. An example of software for creating and reading PDF documents is the Acrobat™ software, also of Adobe Systems, Inc. The Adobe Acrobat software is based on Adobe's PostScript® technology which describes formatted pages of a document in a device-independent fashion. However, PostScript technology is not well suited to the aforementioned dynamic reformatting process.

45 Electronic documents often include one or more articles. For example, a newsletter may include a main article and several secondary articles. Not infrequently, the articles are broken into various sections which may be scattered throughout the document. For example, a main article might start on page one of a newsletter, and conclude on pages three and four of the newsletter. It is therefore apparent that documents transmitted in a predetermined format (such as PDF) may include article sections that are physically separated within the document. This can make the reading of a particular article difficult. While prior software, such as the aforementioned Adobe Acrobat™ software, may include a rich set of pan and zoom options, it can still be difficult to read an article in content flow order to follow the "thread" of the article. 50 Other software, including publishing software such as Personal Press™ of Adobe Systems, Inc. permits columns of an article to be "chained" together, but does not aid a reader in reading the article.

Summary of the Invention

55 The present invention permits an article of a electronic document to be read in content flow order. A reader can therefore follow the "thread" of the article in a convenient, easily comprehended fashion. As the reader navigates through the article, the appropriate portions of the article are automatically panned and zoomed into a reading area of a display window to enhance the readability of those portions of the article.

More particularly, an electronic document viewer of the present invention includes a digital computer system and an electronic document stored in the memory of the computer system. The document includes both article section information and section link information. A computer implemented process determines a desired view mode from a group of pre-defined view modes that include a normal view and an article view. When in the normal view mode, the document viewer displays at least a portion of the document on a computer screen that has the formatting and appearance intended by the publisher of the document. When in the article view mode, at least a portion of a selected article is displayed on the computer screen in an enhanced article view which facilitates in the comfortable reading of the document. Also, when in the article view, the reader can navigate through the article in forward and reverse content flow order by using the article section information and the section link information of the electronic document.

An electronic document system of the present invention includes a document generator and a document reader. The document generator creates a document including one or more articles, each of which has one or more article sections. The document also includes information concerning section links between consecutive sections within a particular article. The document reader can preferably display the document in at least the aforementioned normal view mode and article view mode. When in the article view mode, the document reader makes use of article section information and link information to display portions of the article in an article reading area or window in such a manner that the entire article can be read regardless of the physical arrangement of any article section within the document.

A method for displaying an article of a document on a screen of a computer system in accordance with the present invention includes the steps of: (a) selecting an article for display from within a document stored in the memory of a computer system; (b) determining an initial view pointer which points to an initial portion of the article to be viewed; (c) displaying, as indicated by the view pointer, at least the portion of the article within an article view area of the screen, in a manner to enhance its readability; (d) changing the view pointer; and (e) repeating steps c and d to view other portions of the article. The article can be selected by a variety of modes including selecting an article from a list of articles displayed on the screen, or selecting a visible portion of an article from a document being displayed in the normal view. Preferably, the displaying step causes the selected portion of the article to be automatically sized within the article view area to enhance its readability. This is often referred to as a "zoom." Also, the selected portion is preferably automatically fitted to the window in an operation known as a "pan."

An advantage of the present invention is that an electronic document can be viewed with the appearance of the originally created document. Specific articles within the document can be viewed in an article viewing mode in forward or reverse content flow order. Furthermore, selected portions of the article are automatically panned and zoomed to fit a viewing area or window to enhance the readability of the article.

These and other advantages of the present invention will become apparent to those skilled in the art upon a reading of the following descriptions of the invention and a study of the several figures of the drawing.

#### Brief Description of the Drawings

Fig. 1 is a block diagram of an electronic document viewer in accordance with the present invention;

Fig. 2 is a flow diagram illustrating a process for creating and viewing a document in accordance with the present invention;

Fig. 3 is a flow diagram illustrating the "Create a Document" step 44 of Fig. 2;

Figs. 3a-3f are illustrations used to illustrate, by way of example, the process of Fig. 3;

Fig. 4 is a flow diagram of the "Display And/Or Navigate Article View" step 50 of Fig. 2;

Figs. 4a-4e are illustrations used to illustrate, by way of example, the process of Fig. 4;

Fig. 5 is an illustration of a circular linking structure for article sections in accordance with the present invention;

Fig. 6 illustrates the "Reset Pointer" step 114 of Fig. 4;

Fig. 7 is a flow diagram the "Set Pointer" step 148 of Fig. 6; and

Fig. 8 is a flow diagram of the "Set Pointer" step 150 of Fig. 6.

Detailed Description of the Preferred Embodiments

An electronic document viewer 10 in accordance with the present invention includes a digital processor 12, memory 14, a visual output device such as computer monitor 16, and an input device 18. Certain memory devices 14, computer monitor 16, and input devices 18 are referred to as "peripherals" because they perform peripheral functions for the digital processor 12. Typically, these peripherals are coupled to the microprocessor 12 by electronic interfaces including input/output I/O ports, direct memory access (DMA) circuitry, registers, etc. which have not been included in the block diagram of Fig. 1 because such interfaces are well known to those skilled in the art.

The digital processor 12 is preferably a single chip microprocessor or central processing unit (CPU), such as an 80486™ or Pentium™ processor available from Intel Corporation of Santa Clara, California, a 68040 or PowerPC™ microprocessor available from Motorola, a SPARC microprocessor available from Sun Microsystems of Mountain View, California, etc. The purpose of the microprocessor 12 is to provide the core digital processing for the electronic document viewer 10 of the present invention, and includes various arithmetic, logic, and control functions well known to those skilled in the art.

Memory 14 of the digital computer system 10 includes number of types of memory storage devices which can provide memory storage locations accessible by the digital processor. Therefore, as used herein, "memory" includes RAM memory 20, ROM memory 22, hard disk memory 24, floppy disk memory 26, and any other memory storage location accessible by the digital processor 12 either directly, through an intermediary, or by a peripheral. For example, additional memory may be provided in memory registers, flip-flops, latches, in VRAM associated with the monitor 16, memory locations on a network 28, cache memory, etc. The purposes of memory 14 include providing temporary or "scratch pad" memory, (e.g. RAM 20), semi-permanently stored memory (e.g. hard disk 24 and floppy disk 26), and permanently stored memory (such as ROM 22).

The monitor 16 is coupled to the microprocessor and includes a screen 30 upon which an image 32 can be displayed. Typically, the monitor 16 is a raster-type device (such as a video monitor or a liquid-crystal display panel) having a matrix of picture elements or "pixels" which can be selectably activated to create the image 32. The monitor 16 is a primary method for displaying a document (such as portrayed by the image 32) of the present invention, although other output devices such as printers can also be used.

Input device 18 in the present embodiment includes a keyboard 34 and an electro-mechanical or optical mouse 36. The input device 18 can be used to input information which is acted upon by the digital processor 12 to control a cursor 38 or other pointer on the screen 30 of monitor 16. Other pointer mechanisms such as trackballs, electronic pens, input tablets, etc. are considered to be equivalents of the mouse 36. The interaction of the input device 18 with a document displayed on the monitor 16 will be discussed in greater detail subsequently.

In Fig. 2, a process 40 for creating and viewing documents begins at 42 and continues in a step 44 with the creation of a document including article sections and section links. Next, in a decision step 46, it is determined in which view the document is to be opened. This can be determined by a default (e.g. always open in "normal view"), by opening the document with the same view in which it was closed, by asking the reader, or by determining a proper opening view determined by the publisher of the document. If the view mode is determined to be a normal view, a step 48 is used to display and/or navigate in the normal view, after which process control is returned to step 46. If the view mode is determine to be an article view, a step 50 displays and/or navigates the article in article view. Again, process control is return to step 46 after the completion of step 50. Finally, if other views are desired, those views are displayed and/or navigated in this "other" view in a step 52, after which process control is again returned to decision step 46 to allow the user to view the document in a different view mode. The process 40 is terminated by an appropriate exit command in response to a user input or, optionally, under automated control of the method 40.

In Fig. 3, the step 44 of Fig. 2 "Create a Document" is described in greater detail. The process of step 44 begins at 54 and, in a step 56, a source document is created. Next, in a step 58, the source document is preferably converted into a Portable Document Format (PDF) document. A decision step 60 then permits a user to edit the document reading information. If the author or publisher wishes to edit the article thread, a step 62 is performed to edit the article sections and/or the section links. Process control is then returned to step 60. Alternatively, other edits not germane to the discussion of the present invention are also possible, which can be processed in a step 64, after which process control is once again returned to decision step 60. If the publisher has completed the editing process, the PDF document 66 is then output in a step 68, and the process of step 44 concludes at 68. The PDF document output by step 68 can be stored, transmitted, or otherwise distributed in a number of fashions well known to those skilled in the art. For example, the PDF document can be stored in the RAM memory of a computer, on a computer hard disk, on a floppy disk, on a CD-ROM, can be transmitted over a network or via modem, etc.

The process of step 44 will be discussed by way of example with reference to the illustrations of Figs. 3a-3f. In Fig. 3a, a document 70 is displayed within a window 72 on a computer screen 74 of a computer monitor. In this instance, the document 70 is the first page of a newsletter which has been created using Aldus Personal Press 2.0 from Adobe Systems, Inc. The Aldus Personal Press 2.0 software which created the document 70 is but one example a type of software which can create a document including articles, such as an article 75. Other software packages include word

processors (such as Microsoft Word™ of Microsoft Corporation of Redmond, Washington, WordPerfect™ of Word Perfect Corporation of Orem, Utah, etc.), page layout programs (such as PageMaker™ of Adobe Systems, Inc.), desk top publishing programs, etc.

Once a source document has been created by step 56, it is converted into a Portable Document Format (PDF) document by step 58. Such a PDF document is shown in Fig. 3b. More particularly, a PDF document 76 is shown within a window 78 on a computer screen 80. It should be noted that the PDF document 76 has the formatting and appearance of the originally created document 74 of Fig. 3a after the document 74 has been printed. In fact, in the present invention, the PDF article 76 is created by a printer driver accessed by the software which created the original document 70. In other words, the Aldus Personal Press 2.0 software utilizes a PDF printer driver to "print" to disk the PDF document 76. This process of creating a PDF document 76 from an original document 70 is known, and is practiced by the aforementioned Adobe Acrobat™ software program, among others.

The process of step 62 "Edit Article Sections And/Or Section Links" will be discussed with reference to Figs. 3c-3f. As noted in Fig. 3c, the document 76 in window 78 includes a number of items including a masthead 82, a contents section 84, and a portion of an article 86. These "items" or "objects" are viewed as the publisher intended to, i.e. the content, arrangement, format, and appearance of the document 76 reflects the desired presentation by publisher.

Assume that the document 76 includes two pages, and that the article 86 is provided in three columns on those two pages. The present invention allows the article 86 to be read in forward or reverse content flow directions to facilitate in the efficient and comfortable reading of the article.

At this point it would be useful to define some of the terms being used in the specifications. Throughout the specification, the expression "document," "electronic document," "document content information," and the like are used somewhat interchangeably to denote a collection of information (such as text and graphical elements) and potentially including multimedia content (such as sound or video) as well as control elements such as hyperlinks or stored control programs or scripts. The term "article" is used to denote a logically related and ordered portion of the information in the document. When referring to "content flow," it is meant herein the logical ordering of information within an article irrespective with the physical ordering of information in a particular layout of the document and irrespective of the physical ordering of information in any digital representation of the document. Throughout the specification the expression "layout" and "format" are used somewhat interchangeably to denote the process of determining a particular physical relationship and appearance for document content information. For example, layout and format information determine line breaks, hyphenation, and justification for text, and determine size and relative positioning of graphical elements. The process of "laying-out" or "formatting" generally includes dividing some or all of the document information into sets of pages of a particular size. When used as nouns, "layout" and "format" denote an output of the layout and format processes, e.g. for some document a particular physical arrangement of some or all of its constituent information. As used herein, "column" is used to denote a portion of a page containing part or all of the information in an article within a particular layout of a document. A column is frequently, but not necessarily rectangular and, therefore, can be said to be bounded by a rectangle or "bounding box." When referring to a column, the term "origin" is used to denote the initial part of information within a column, and the term "width" is used to denote the physical width of a column, in reading order. The specific geometric interpretation of these terms may be system, article content, layout dependent, and written language dependent. For example, some certain languages are read from right to left or bottom to top. However, as discussed herein, the present invention is preferably used in conjunction with Roman alphabetic text where the reading order is left to right and top to bottom. In this context, the origin of a column is therefore the geometric top left of its rectangle and the width of a column is the left-to-right width of its rectangle. An "article section" is a part of an article that is coupled to another article section by an "article thread", which is an imaginary thread or line along the content flow of an article. An article section can be either shorter, longer, or the same height as a window in which it is displayed. An "article portion" is a part of an article that is displayed within a window. Therefore, an "article portion" can be either shorter, longer, or the same length as an article section. Typically, however, article sections are longer than the window in which they are displayed and, therefore, longer than the article portions.

With continuing reference to Fig. 3c, an article thread is developed with an appropriate tool. In this instance, the tool is accessed from a pull-down menu (not shown) under the label "Tools" which has an article tool selection for creating article sections and links. The selection of the article tool of the pull-down menu creates a cursor 88 on the screen 80 which can be used to create a bounding box 90. More particularly, a pointing mechanism (such as mouse 36) can be used to initially position the cursor 88 at a position 88a and to then "drag" the cursor to its final position at 88 to create the bounding box 90 shown in broken lines. This action allows a user to manually create a first article section 92 as shown in Fig. 3d. In the present invention, the article section 92 created by the aforementioned process includes a header 94 including information about the article and article section. In this instance, the article 94 indicates "1-1" which indicates that this is article number one, and section number one. The cursor 88 is then used to create additional article sections 96 and 98 having headers 100 and 102, respectively (see Fig. 3e). The header 100 indicates that article section 96 is the second article section of article number one, and article header 102 indicates that article section 98 is the third article section of article number one.

If the document 76 includes more than one article, the article tools from the tools pull-down menu (not shown) can be accessed again to turn off the article section selection mode and then it can be thereafter selected again to repeat the article selection process for additional articles. In fact, within practical limits, any number of articles can be provided with any number of article sections. It should also be noted that the article sections do not need to be full columns but, rather can be portions of the column, for example, each paragraph of a column can be a section.

In the present invention, as the article sections are sequentially selected, an article "link" is created within the document 76 to link the sequence article sections together. Therefore, in the present invention, it is important for the creator of the document to select the article sections in content flow order. For example, if article section 98 were to be selected before article section 96, the content flow order would proceed from article section 92 to article section 98 and then article section 96. Appropriate editors can be provided to edit the links to thereby modify the article flow.

It should also be noted that, in this preferred embodiment, the linkages between the article sections are preferably circular. That is, the first article section is preferably linked to the last article section such that forward scrolling from the last article section will access the first article section, and such that a rearward scrolling from the first article section will access the last article section. Alternatively, the links can be open-ended or non-circular such that the first article section is not directly linked to the last article section.

In the described embodiment, the article sections are manually selected and the sections links are automatically provided. Alternatively, the article sections can be selected automatically and the linkages can be made manually. For example, the process of the present invention can recognize columns of text as articles and automatically provide a bounding box for all recognized article sections. A publisher can then use an input device to select which of the article sections should be linked and in which order. In yet another embodiment of the present invention, the article sections and the article links can be designated manually, and in a fully automated embodiment of the present invention, the article sections and links can be provided automatically based upon recognition technology and heuristics provided by the process. However, this fully automated embodiment will likely require a fair amount of editing to correct errors made by erroneous assumptions by the process.

While the prior art does disclose tools for manually selecting columns and manually "chaining" columns together (e.g. for newsletter publishing programs), it does not disclose the automatic creation and/or linking of article sections, nor does it disclose a circular linking process wherein a first and a last article section of an article are linked together.

After the article sections have been selected and linked, a window 104 as illustrated in Fig. 3f is provided for the entry of article properties. More specifically, window 104 allows the title, subject, author, and key words pertaining to the article to be entered into the viewing system. The entries into the window 104 may be automatic or manual. For example, the title could be automatically provided by inserting the first paragraph (i.e. the title) of the article. However, it is more likely that the title, subject, author, and key words are manually entered such as through keyboard 34. As will be discussed in more detail subsequently, the article properties can be used to help find and select a desired article for viewing.

In Fig. 4, the process of step 50 of Fig. 2 "Display And/Or Navigate Article View" is shown in greater detail. The process of step 50 begins at 104 and, in a step 105, the "original" view parameters are saved to permit the optional return to the same view that the user just exited. For example, users that were in a normal view prior to entering the article view, may wish to return to the same point in the normal view after completing their reading in the article view. It is for this purpose that the original view parameters are saved in step 105.

Next, in a step 107, a pointer position is determined and a visual indicator is set to the pointer position. In the present invention, the pointer is used to point to the beginning of an article portion that is displayed within a window. With typical text which is read left-to-right, top-to-bottom, this means that the pointer is pointing to the line of an article portion which will be displayed at the top of the window. The visual indicator, in contrast, points to the location in the article portion displayed in the window that the reader is most likely going to read next. The visual indicator is provided so that readers do not lose their place when a new article portion is displayed in the window. Therefore, the visual indicator minimizes the problem of having readers searching for the next line of text to read in an article after a new article portion is displayed in the window.

The initial pointer position can be determined by a number of methods. For example, the initial pointer position can be set to the top of the article section that was selected by a cursor at the time that a mouse button was clicked. Alternatively, an option-click can set the initial pointer to the top of the article, or the pointer could always be set to the top of an article by default.

Next, in a step 106, information is retrieved concerning the current article section as determined by the pointer into the article. As mentioned above and as will be discussed in greater detail subsequently, the pointer is used to point to the top of the article portion to be viewed during the article view mode. Next, in a step 108, a portion of the article section is sized to the window to enhance readability up to a maximum zoom amount. This step 108 therefore performs both a "pan" and "zoom" function by moving the desired portion of the article into an article viewing area of a window and then increasing the size of the portion of the article to make it more readable.

In addition, step 108 provides the visual indicator. As mentioned previously, the visual indicator indicates the position or close to the position of the next line to be read by the user. An example of a visual indicator is found in Figs. 4c-4e. In this instance, the visual indicator is a small triangle or arrow-head which is positioned just outside the window 78 and

points to the next line to be read. In Fig. 4c, the top of the article is displayed and, therefore, the visual indicator is pointing to the first line within the window 78. Note, however, in Fig. 4d that the visual indicator 131 is pointing to a point within the article portion rather than to the top of the article portion. This is because the next line to be read within the article portion displayed in Fig. 4d begins with the words "terms of a means...", which follow the last sentence of the article portion displayed in Fig. 4a which ends with the words "... an invention may be claimed in..." The visual indicator may be removed after a short period of time (e.g. about a second), as the user continues to read. Alternatively, the visual indicator may be left in place until a new article portion is displayed within the window.

It should be noted that there are a variety of ways of providing a "visual indicator." For example, the next line to be read could be momentarily highlighted in reverse video. Alternatively, the next line to be read could be displayed normally, and the remainder of the article portion could be shown in half-tone for a short period of time. It should also be noted that the visual indicator may not exactly point to the next line of text to be read. This is because the article is stored in a graphic-oriented (not line oriented) format. There may, therefore, be a graphic at the next "reading" position. Alternatively, the font size may be smaller or larger than average, changing the line spacing. The "next line" is therefore an approximation which is preferably calculated using an "average" line height, such as sixteen pixels. In consequence, the visual indicator may point slightly above or slightly below the actual line to be read.

With continuing reference to Fig. 4, a decision step 110 determines whether the user wishes to exit from the article viewing mode. If not, the process of step 50 looks for some type of scroll command in a decision step 112. If there is no scroll command, the process of step 50 enters a loop waiting for an exit, scroll, or some other type of command (not shown).

In the present embodiment, two types of scrolls are supported. One type of scroll is the normal page scroll which allows a reader to scroll around in the current page. This is typically controlled by the computer's operating system or presentation manager. The other type of scroll is an article scroll which causes a forward or reverse, quantized scrolling of a portion of an article along an article thread defined by a content flow of the article. If the scroll detected at step 112 is an article scroll, a step 114 is used to reset the pointer and process control is returned to step 106 to display a new portion of the article. It should be noted that this new portion of the article is automatically panned and zoomed to fit within the article view area of the window, as with the previous article section, to enhance readability.

If the step 112 detects a page scroll, a scroll command is generated and the user is allowed to scroll within the page. This page scroll is typically accomplished by the use of the standard horizontal and vertical scroll bars provided in Macintosh Windows, Microsoft Windows, etc. Next, a step 118 determines whether the act of scrolling has caused the user to leave the current page. If not, a step 120 determines whether scrolling is completed. The scrolling is not completed, steps 116 and 118 are repeated until scrolling is completed, at which time process control returns to step 110.

There are several ways for exiting the article view mode in accordance with the present invention. One is an explicit command to exit as detected by decision step 110. The other is the act of leaving the page during a page scroll as detected by step 118. There are, of course, other ways to exit, such as a use of a hot key, etc. In any event, when it is desired by the user to leave the article view mode, process control is turned over to decision step 121 which determines whether the original view should be restored. As explained previously with reference to step 105, the original view parameters are stored so that users may optionally return to the same view that they had previously exited. Step 121 can determine whether to restore the original view by default, or based upon certain heuristics, or by asking the user, or by looking for a command sequence from the user (e.g. pressing a certain function key or command sequence on the keyboard). If the original view is to be restored, the original view parameters are restored in step 123. In either event (i.e. whether or not the original view is to be restored) the view mode is then set to a normal view in a step 122. The process of step 50 is then completed at 124.

The process of step 50 of Fig. 4 will be described by way of an example with reference to Figs. 4a-4e. In Fig. 4a, the document 76 is displayed within window 78 on computer screen 80 in a "normal view" including a number of article and non-article items such as masthead 82, content list 84, and article 86. A first method of the present invention for leaving a normal view mode and entering an article view mode as detected by decision step 46 of Fig. 2 is to select a "hand" icon from the horizontal tool bar at the top of screen 80 to create a hand cursor 126 on the document 76. The hand cursor 126 includes an arrow 128 which indicates direction for article scrolling, i.e. either forward (in the direction of content flow) or reverse (in the reverse direction of content flow). By "clicking" a button on mouse 36, the hand cursor 126 will select the article 86 for the entry into the article view mode.

An alternative method for entering the article view mode is illustrated in Fig. 4b. In this method, an article window 130 lists all of the articles in the document. This article window derives the titles from the aforementioned article properties, as entered into the window 104 of Fig. 3f. In this instance, there is only one article in the document that can be selected but, typically, there will be a list of a number of articles which can be selected by means of an appropriate pointing mechanism such as a mouse 36. In any event, either of the methods of Fig. 4a or Fig. 4b can be used to select an article to view in an article mode. Of course, other selection mechanisms are also possible. For example, a "hyperlink" from another application program could be used to launch the article reading mode. With a hyperlink, a button or other icon can be selected which can activate the viewer of the present invention, set the article viewing mode, and set the

pointer to an appropriate point in an article. As well known by those skilled in the art, hyperlinks therefore can operate much like "macros" to perform a series of sometimes conditional steps to achieve a desired result.

After an article has been selected for viewing in the article view mode, steps 106 and 108 of Fig. 4 occur. In other words, information concerning the current article section as determined by a pointer is retrieved, and then a portion of the article section is scaled to the window with a maximum zoom for enhanced readability (see Figure 4c). In this instance, the article viewing area is the window 78 which previously displayed the document in the normal view. However, as noted, an article portion 132 has been scaled to about the size of this window 78 to enhance the readability of that portion. More specifically, window 78 has a width W and a length L. Typically, as a default, an internally stored pointer P points to the top of the first section of the article when the article has been selected by title, or to the top of the article section that was selected by the hand cursor 126. A process 108 then "pans" and "zooms" the document so that the article section starting at the pointer P is scaled in the horizontal direction to fit about the width W of the window 78. This scaling factor will determine the length of the article portion that will be displayed within the length L of the window 78. However, it has been found that there is a maximum amount of magnification or "zoom" that is comfortable to some readers. Therefore, it is possible that there is a maximum "zoom" (such as a 200% magnification) that will be allowed by the step 108. In such an event, the width of the article portion 32 will be somewhat less than the width W of the window 78 but, as a beneficial side effect, more of the length of the article portion 132 will be displayed within the window 78.

More specifically, the process 108 preferably first sets the current zoom to the maximum zoom indicated by the reader. Then, process 108 determines if the article width is greater than the window width at that zoom level. If it is not, the article portion is preferably centered within the window. If the article width is greater than the window width at the maximum zoom level, the current zoom level is adjusted as follows:

$$\text{current zoom} \leq \text{maximum zoom} * (\text{window width} / \text{article width})$$

Therefore, the zoom is scaled back by the ratio of the window width to the article width so that the article portion will fit the window.

If the hand cursor 126 is activated, the next view in the direction of the arrow 128 will be displayed. In other words, the activation of the user input device (such as mouse 36) will cause an article scroll of a portion of an article in a desired direction respective to the thread or content flow of the article.

In Fig. 4d, the next consecutive portion of the article is shown within window 78. In other words, decision step 112 detects the activation or "clicking" of the mouse at the position indicated by cursor 126 of Fig. 4c and determines that an article scroll is being commanded. Step 114 then resets the pointer P to a position P<sub>1</sub> in the article and steps 106 and 108 cause a pan and zoom to display a second portion 134 of the article and window 78. It should be noted that this portion 134 includes the bottom region of the article section 1-1.

Fig. 4e illustrates what happens after the mouse is once again "clicked" when the hand cursor is at the bottom portion 134 of article section 1-1 as seen in Fig. 4d. The decision step 112 again determines that an article scroll command has been made and the pointer is reset from point P<sub>1</sub> in the article to the point P<sub>2</sub>. This is accomplished because, due to the article links described previously, the bottom of the first article section 1-1 is considered to be consecutive (in a logical or content flow sense) with the top of the second article section 1-2. In other words, the article sections are considered to be consecutive due to their section links regardless of their physical location within the printed or display document and regardless of their storage locations and memory. Once again, steps 106 and 108 retrieve the appropriate information and then pan and scale the document to present portion 136 of the article within the window 78.

It should be noted that the scaling of the portions 132 (Fig. 4c) and 134 (Fig. 4d) is about 110%. However, as seen in Fig. 4e, the scaling of portion 136 is approximately 121%. This automated scaling for enhanced viewability relieves the user of the necessity of manually panning and zooming to make the article readable.

It should also be noted that the hand cursor 126 in Fig. 4e has an arrow 128a which points in an upward direction. In this instance, clicking the mouse with the cursor 126 and arrow 128a as shown will cause an upward article scroll such that the article portion 136 is replaced with the article portion of Fig. 4d. Therefore, it is clear that the thread of the article can be followed in either direction.

Fig. 5 illustrates in graphical form the three article sections 1-1, 1-2, and 1-3 of an article A1. The links are indicated by the arrows 138, 140 and 142. Link 138 is between the bottom of the article section 1-1 and the top of the article section 1-2, link 140 is between the bottom of article section 1-2 and the top of article section 1-3, and link 142 is between the bottom of article section 1-3 and the top of article section 1-1. Therefore, the section links preferably form an ordering with a circular link structure. In essence, section link 138 makes the bottom of article section 1-1 consecutive with the top of article section 1-2 and section link 140 makes the bottom of article section 1-2 consecutive with the top of article section 1-3. Section link 142 (which is optional) makes the bottom of section 1-3 consecutive with the top of article section 1-1. Therefore any article scrolling which goes beyond a top or bottom of one of the article sections will create an article scroll to the next consecutive article section.



The combination of the article sections 1-1, 1-2, and 1-3 along with section links 138 and 140 (and optionally section link 142) creates an article thread T. If the article thread is followed in the forward direction, i.e. from article section 1-1 to article sections 1-2 and 1-3, the thread is in the direction of article content information flow. However, a user can also navigate in the reverse direction along thread T, i.e. in the reverse direction of content information flow.

5 The article thread T can be implemented in a variety of fashion, as will be appreciated by those skilled in the art. In the present embodiment of the invention, the article threads are implemented as "objects" within a computer implemented process. The creation and use of objects are well known to those skilled in the art.

PDF documents created by the present embodiment of the invention include zero or more article thread objects. Each thread will have a title, and a list of thread elements (referred to as "beads"), which correspond to article sections. 10 If a document includes any threads, they are stored in an array as the value of the "Threads" key in a Catalog object. As used herein, an "array" is an ordered list of elements which can be accessed by an array index. Each thread and each thread bead is defined as a dictionary. As used herein, a "dictionary" is a set whose elements can be accessed by name (i.e. a set of key-value pairs). A description of the PDF™ format version 1.0, including arrays and dictionaries, can be found in The Portable Document Format Reference Manual, Adobe Systems, Inc., Addison-Wesley, 1993, which is incorporated herein by reference. The key-value pairs for thread and thread bead dictionaries are found below in 15 Tables 1 and 2, respectively.

Table 1

(Key-Value Pairs in a Thread Dictionary)	
<u>Title String</u> :	(optional) The text name of the thread. The characters in this string are encoded using a predefined encoding PDFDocEncoding
<u>ThreadInfo dictionary</u> :	(optional) Contains key-value pairs describing thread attributes, such as Date, Author, Keywords, etc.
<u>First dictionary</u> :	(required) This specifies which bead is the first element in the thread

Table 2

(Key-Value Pairs in a Bead Dictionary)	
<u>Thread dictionary</u> :	(required for first bead in thread) Specifies the thread of which this bead is the first element.
<u>Prev dictionary</u> :	(required) Specifies the previous bead of this thread. For the first bead of a thread, Prev specifies the last bead of the thread
<u>Next dictionary</u> :	(required) Specifies the next bead of this thread. For the last bead of the thread, Next specifies the first bead of the thread.
<u>Page dictionary</u> :	(required) Specifies the page upon which this bead appears.
<u>Rect array</u> :	(required) Rectangle (bounding box) specifying this bead (article section)

45 In Fig. 6, the "Reset Pointer" step 114 of Fig. 4 is shown in greater detail. The process of step 114 begins at 144 and, in a step 146, the scroll direction is determined. Scroll direction can be selected by the user in a number of well-known fashions. For example, if the mouse button is clicked with without pressing "shift" or some other "command" key, the scroll direction may be assumed to be down. If the mouse button is clicked while simultaneously pressing the shift key or some other command key, the scroll direction may be assumed to be up.

50 If the scroll direction is "down" the user desires to navigate through the article in the direction of content flow. This is accomplished by setting the pointer to the top of the next article portion as shown in step 148. If the scroll direction is "up", the user wishes to view the article in reverse content flow direction. This might occur, for example, if users wish to review something that they had just read. In this instance, a step 150 set the pointer into the previous article portion. The process of step 144 then ends at 152.

55 In Fig. 7, step 148 of Fig. 6, i.e. the downward article scroll, is illustrated in greater detail. The process 148 begins at 154 and, in a step 156 it is determined whether the end of the article section in within the current window. If not, a step 158 sets the visual indicator to the bottom of the window plus an offset. The offset is, as previously mentioned, about one line spacing. In the present embodiment, the offset is assumed to be about 16 pixels. Next, in a step 160, it is determined whether the next article portion is less than a full window in height. If it is, a step 162 sets the pointer to



the bottom of the article section minus the window height. An example of this situation is seen in Fig. 4d. If step 160 determines that the next portion is not less than the window height, the pointer is set to the top of the next portion minus the offset. The process 148 is completed as indicated at 166 after the completion of steps 162 or 164.

If step 156 determines that the end of the article section is within the window, a step 168 determines whether this is the last section in the article. If yes, a step 170 determines whether the article sections are circularly linked, i.e. if the end of the last article section is linked to the beginning of the first article section and vice versa. If not, an error message (such as a beep) is generated in step 172, and the process 148 terminates at 166. If step 168 determines that it is not the last section in the article, or if step 170 determines that the article sections are circularly linked, then a step 174 sets the pointer and the visual indicator to the top of the next article section not currently fully visible in the window.

Step 174 therefore anticipates the situation where the article section heights are shorter than the window height, thereby allowing multiple article sections to be displayed within a window simultaneously, although only the first article section would be associated with the pointer and the visual indicator. In such an instance, the next logical article section to be viewed is the next article section not fully visible in the screen. If the article section is longer than the window height, the pointer and the visual indicator are set to the top of the next article section. The process 148 is then complete at 166.

In Fig. 8, step 150 of Fig. 8 is detailed. More specifically, an article up-scroll begins at 176 and, in a step 178, it is determined whether the beginning of an article section is within the display window. If not, a step 180 determines if the article portion preceding the current article portion is less than a window in height. If so, the pointer is set to the top of the current article section. If step 180 determines that the previous portion is not less than the window height, a step 184 sets the pointer to the current pointer position (i.e. the top of the current window) minus the window height. After the completion of either step 182 or 184, the visual indicator is set to the pointer, and the process 150 ends at 188.

If step 178 determines that the beginning of the current article section is within the window, then a step 190 determines whether the current article section is the first section in the article. If so, a step 192 determines whether the article sections are circularly linked, as described above. If not, an error message (e.g. a beep) is made by step 194 and the process completes at 188. If step 190 determines that the current article section is not the first article section, or if step 192 determines that the article sections are circularly linked, a step 196 sets the pointer to the bottom of the previous section that is not fully visible in the window minus one window height. This step 196 is quite analogous to the previously described step 174. Essentially, this step 196 takes care of both the situation where the article sections are shorter than the window height and longer than the window height. Step 186 then sets the visual indicator to the pointer position, and the process is completed at 188.

While this invention has been described in terms of several preferred embodiments, it is contemplated that alternatives, modifications, permutations and equivalents thereof will become apparent to those skilled in the art upon a reading of the specification and study of the drawings. It is therefore intended that the following appended claims include all such alternatives, modifications, permutations and equivalents as fall within the true spirit and scope of the present invention.

## Claims

### 1. An electronic document viewer comprising:

a digital computer system including a digital processor, memory which provides memory storage locations accessible by said digital processor, a visual output device to provide a visual output derived, at least in part, from said digital processor, and an input device to provide an input that can be acted upon by said digital processor;

a document stored in said memory and including at least one article, said document including article section information and section link information describing an ordering of said article sections of an article such that said article sections can be accessed in a consecutive fashion;

means implemented on said digital computer system for determining one of a plurality of view modes including at least a normal view mode and an article view mode;

normal view means implemented on said digital computer system for displaying at least a portion of said document on said visual output device in a normal view that does not require said article section information and article section link information; and

article view means implemented on said digital computer system for displaying at least a portion of a selected article on said visual output device in an article view, and for permitting the sequential viewing of consecutive article sections of said selected article based upon said section link information.

### 2. An electronic document viewer as recited in claim 1 wherein said document further includes at least one additional item, wherein said additional item may be viewed in said normal view mode, but is not viewed in said article view mode.

3. An electronic document viewer as recited in claim 2 wherein said normal view means displays at least a portion of said document in a window on said output device, and is responsive to said input device to permit other portions of said document to be viewed within said window.
- 5 4. An electronic document viewer as recited in claim 1 wherein said document includes a plurality of articles, each of which comprises a plurality of article sections and associated section links.
5. An electronic document viewer as recited in claim 1 wherein said article view means displays at least a portion of said selected article in a window on said output device, and is responsive to said input device to permit other portions  
10 of said article to be viewed within said window.
6. An electronic document viewer as recited in claim 5 wherein said portion of said selected article is automatically sized to said window by said article view means to enhance the readability of said portion.
- 15 7. An electronic document viewer as recited in claim 6 further comprising a visual indicator to indicate a starting point for reading in said portion.
8. An electronic document viewer as recited in claim 6 wherein said portion is automatically sized by adjusting the size of said article such that a width of said article is sized towards a width of said window.  
20
9. An electronic document viewer as recited in claim 8 wherein said portion is automatically sized such that any increase in size of said portion is limited to a maximum increase.
10. An electronic document viewer as recited in claim 6 wherein a length of said portion that is displayed in said window  
25 is determined by said automatic sizing.
11. An electronic document viewer as recited in claim 10 wherein said additional portions of said selected article are displayed consecutively with said portion of said article that is displayed in said window.
- 30 12. An electronic document viewer as recited in claim 11 wherein a first article section is linked to a last article section of an article such that said first article section is displayed consecutively with a second article section and said last article section, and said last article section is displayed consecutively with a penultimate article section and said first article section.
- 35 13. An electronic document viewer as recited in claim 1 further comprising article view exit means implemented on said digital computer system for returning to said normal view upon an exit from said article view.
14. An electronic document viewer as recited in claim 13 wherein said article view exit means restores about the same  
40 normal view image that was displayed just prior to entering said article view.
15. A method for viewing electronic documents on a digital computer comprising the steps of:  
storing in a memory of a digital computer an electronic document including at least one article having article  
sections and section links between article sections such that said article sections can be accessed in a consecutive  
45 fashion regardless of a physical positioning of an article section within said document;  
selecting an article to be displayed on an output device of said digital computer in an article viewing mode;  
displaying with said output device at least a portion of said article; and  
using an input device of said digital computer to cause the display of additional portions of said article with  
said output device, where said additional portions can be determined, at least in part, by said article sections and  
said section links.  
50
16. A method as recited in claim 15 wherein said step of selecting an article comprises selecting an article from a list  
of articles with said input device.
17. A method as recited in claim 15 wherein said step of selecting an article comprises the use of a hyperlink or macro.  
55
18. A method as recited in claim 15 wherein said step of selecting an article comprises selecting an article from a view  
of said document that includes said article.

19. A method as recited in claim 18 wherein said step of selecting an article comprises pressing a button associated with a pointing system, and wherein said article portion will begin at one of the top of the article section so selected or at the top of the article so selected.
- 5 20. A method as recited in claim 15 wherein said step of displaying includes displaying at least said portion of said article within a window on said output device of said digital computer.
21. A method as recited in claim 15 wherein said displaying step further includes displaying a visual pointer indicating the reading position within said article portion.
- 10 22. A method as recited in claim 20 wherein said step of displaying further causes said portion to be automatically sized to said window to enhance the readability of said portion.
23. A method as recited in claim 22 wherein said portion is automatically sized by adjusting the size of said article such that a width of said article is sized towards a width of said window.
- 15 24. A method as recited in claim 23 wherein said portion is automatically sized such that any increase in size of said portion is limited to a maximum increase.
- 20 25. A method as recited in claim 24 wherein a length of said portion that is displayed in said window is determined by said automatic sizing.
26. A method as recited in claim 25 wherein additional portions of said selected article are displayed consecutively with said portion of said article that is displayed in said window.
- 25 27. A method as recited in claim 26 wherein a first article section is linked to a last article section for an article such that said first article section is displayed consecutively with a second article section and said last article section, and said last article section is displayed consecutively with a penultimate article section and said first article section.
- 30 28. An electronic document system comprising:  
a document generator for creating a document including at least one article having a plurality of article sections, said document including article section information and section link information that describes links between related article sections of an article; and  
a document reader for displaying said document in a plurality of view modes including at least a normal view mode and an article view mode, where said normal view mode does not require the use of said article section information and section link information, and where said article view mode makes use of said article section information and said link information to display at least portions of said article, such that the entirety of said article can be viewed in a consecutive fashion regardless of the physical arrangement of any article section within said document.
- 35 29. An electronic document system as recited in claim 28 wherein said document generator comprises:  
a visual display to display at least a portion of said document; and  
a pointer mechanism for selecting article sections within said display of at least said portion of said document.
- 40 30. An electronic document system as recited in claim 29 wherein after a newly selected article section is selected by said pointer mechanism it is automatically linked to a previously selected article section.
- 45 31. An electronic document system as recited in claim 29 wherein said pointer mechanism is used to manually link and unlink article sections.
- 50 32. A method for displaying an article of a document on a screen of a computer system comprising the steps of:  
(a) selecting an article to display on a screen of a computer system from within a document stored in memory of said computer system;  
(b) determining an initial view pointer which points to an initial portion within said article;  
(c) displaying, as indicated by said view pointer, at least a portion of said article within an article view area of said screen, said portion of said article being sized within said article view area to enhance its readability;  
(d) changing said view pointer; and  
(e) repeating steps c and d to view consecutive portions within said article.
- 55

33. A method as recited in claim 32 wherein step (c) further includes displaying a visual indicator of the current reading position within said portion of said article.
- 5 34. A method as recited in claim 32 wherein said step of selecting an article includes selecting an article from a list of articles displayed on said screen.
35. A method as recited in claim 32 wherein said step of selecting an article includes selecting an image of said article displayed on said screen along with other portions of said document.
- 10 36. A method as recited in claim 32 wherein said step of selecting an article comprises at least one of activating a hyperlink or a macro.
37. A method as recited in claim 32 wherein said initial view pointer points to a top portion of said article.
- 15 38. A method as recited in claim 32 wherein said displaying step causes said portion to be automatically sized to said article view area to enhance the readability of said portion.
39. A method as recited in claim 38 wherein said portion is automatically sized by adjusting the size of said article such that a width of said article is sized towards a width of said article view area.
- 20 40. A method as recited in claim 39 wherein said portion is automatically sized such that any increase in size of said portion is limited to a maximum increase.
- 25 41. A method as recited in claim 40 wherein a length of said portion that is displayed in said article view area is determined by said automatic sizing.
42. A method as recited in claim 32 wherein said step of changing said view pointer comprises setting said view pointer to a next consecutive portion of said article to be viewed.
- 30 43. A method as recited in claim 42 wherein said next consecutive portion is forward in said article.
44. A method as recited in claim 42 wherein said next consecutive portion is backward in said article.
- 35 45. A reader for arranging a document provided in a predetermined format and including an article having content flow information, said reader comprising:  
a selector to select an article of said document to be read;  
a displayer to display a first portion of said article in a manner for easy viewing and comprehension; and  
a navigator which, after said first portion of said article has been displayed, permits the display of the next and remaining sequential portions of said article in content flow order.
- 40 46. A reader as recited in claim 45 wherein said displayer provides at least one of a pan and a zoom of said first, next, and remaining portions of said article, as required for easy viewing and comprehension.
- 45 47. A reader as recited in claim 45 further comprising a visual indicator for indicating a reading position in a portion of said article being displayed.

50

55

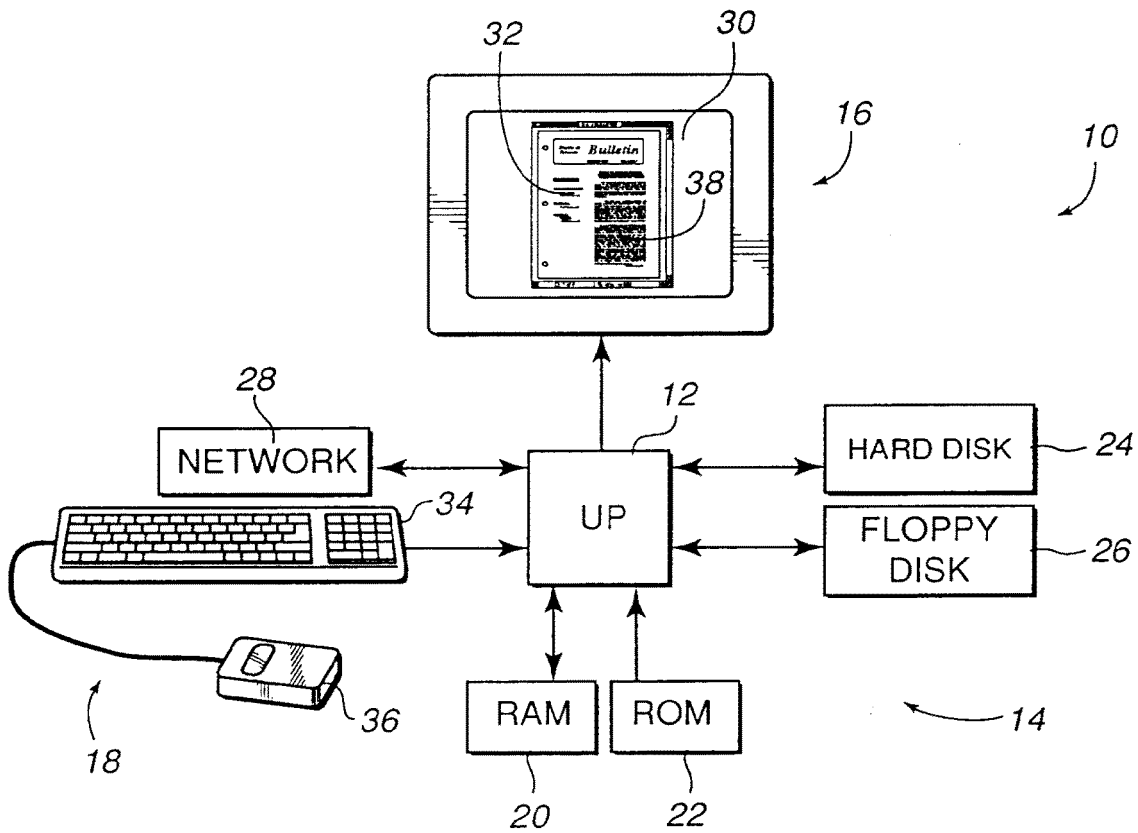

Fig. 1

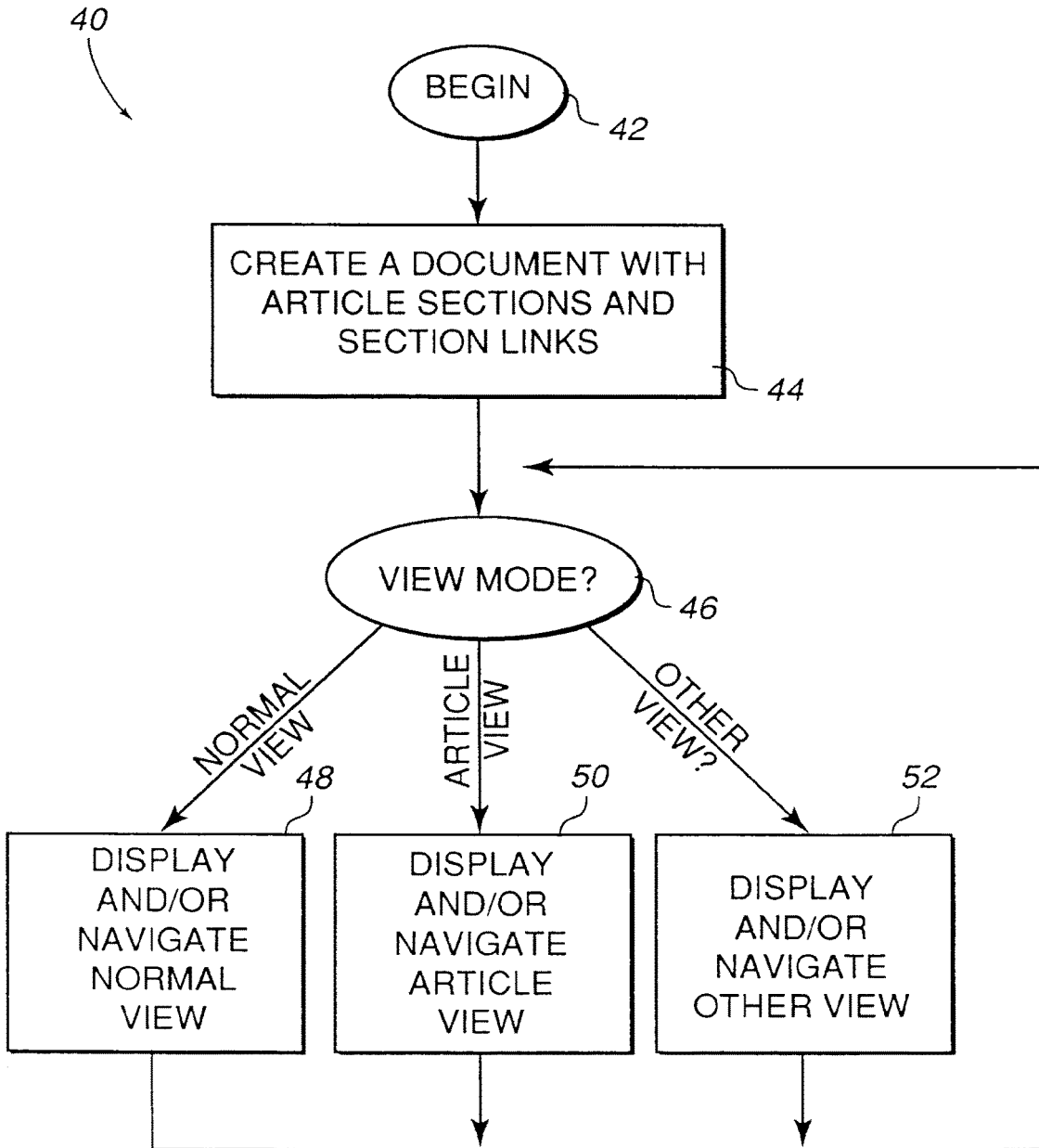

Fig. 2

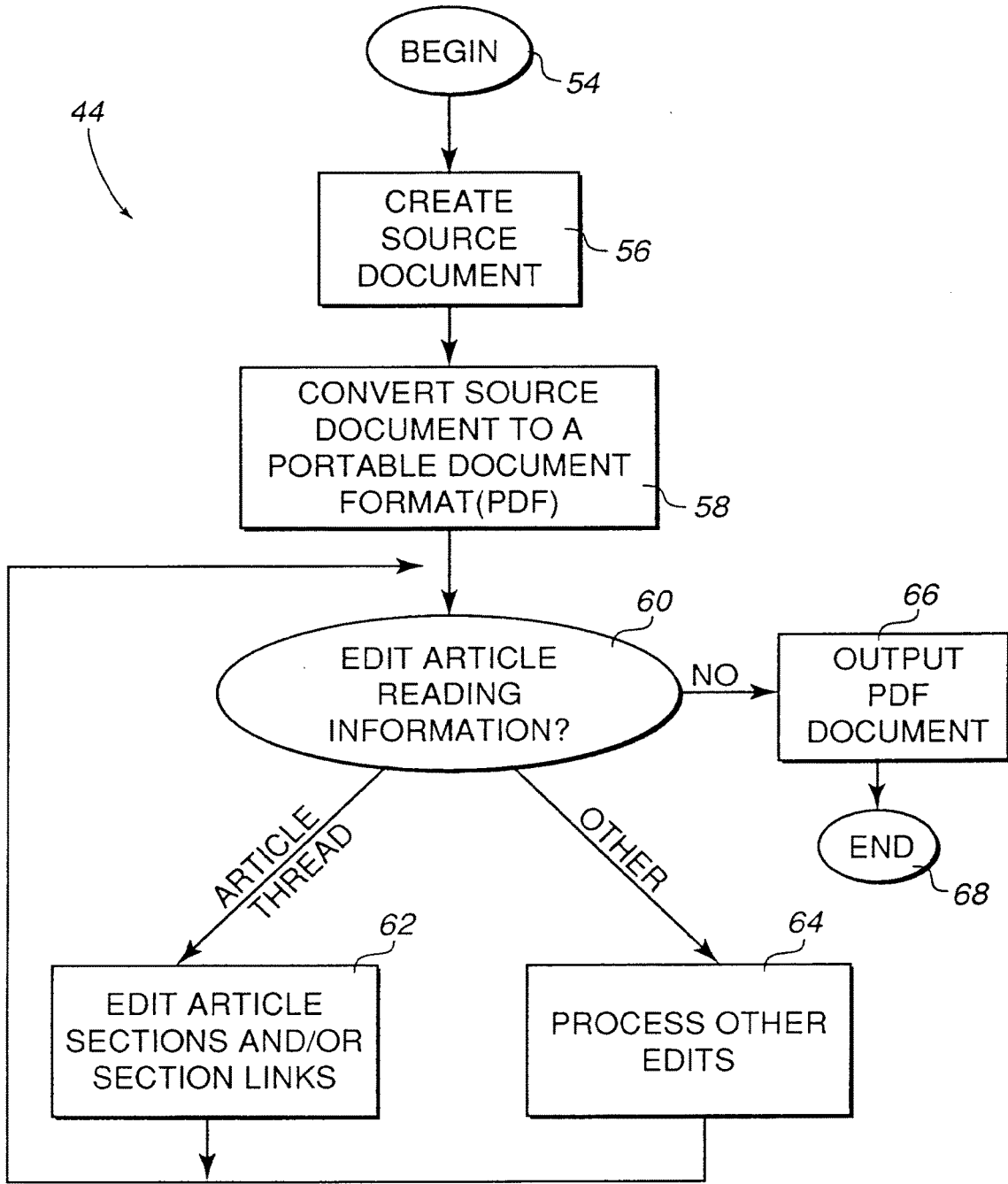

Fig. 3

Fig. 3a

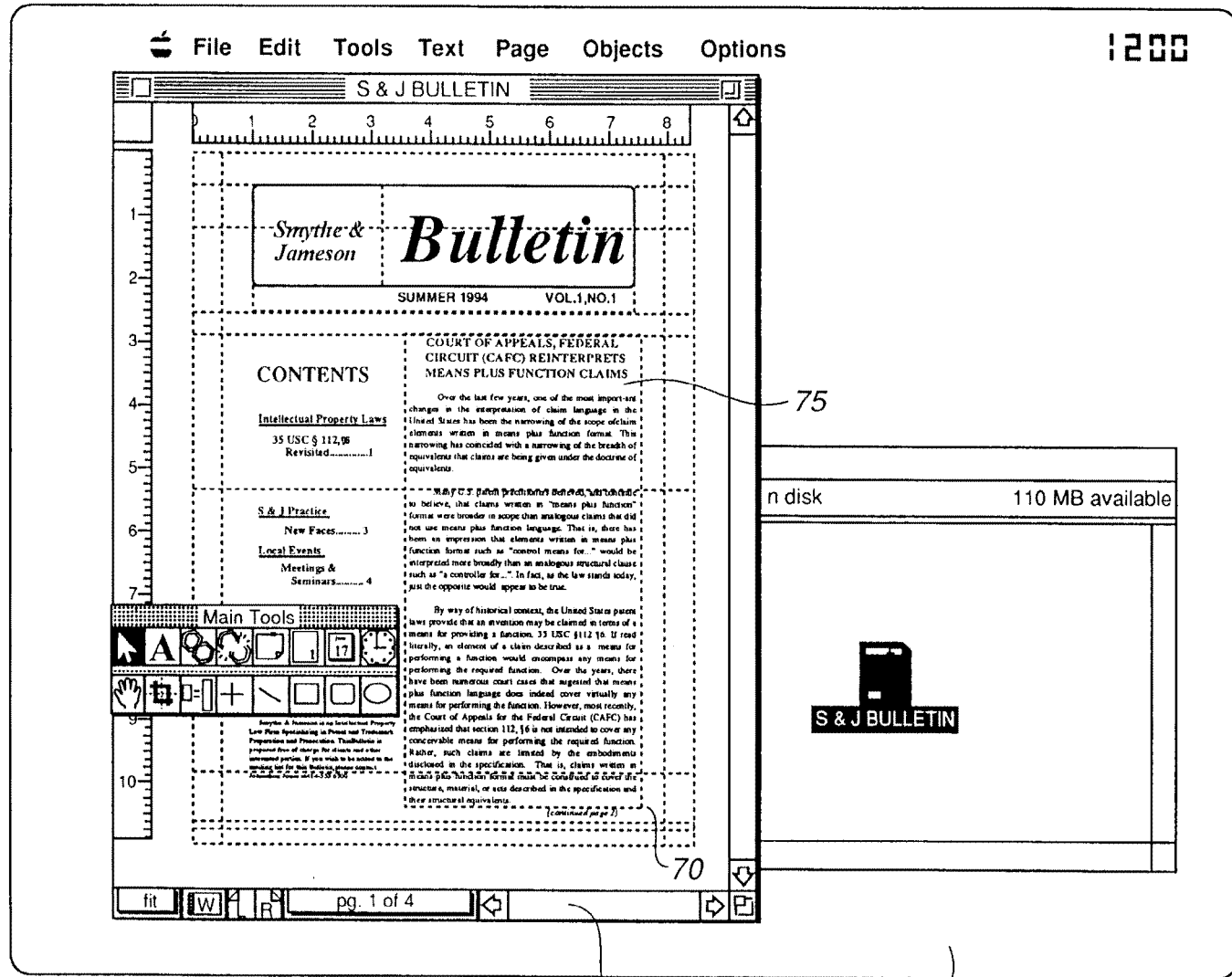
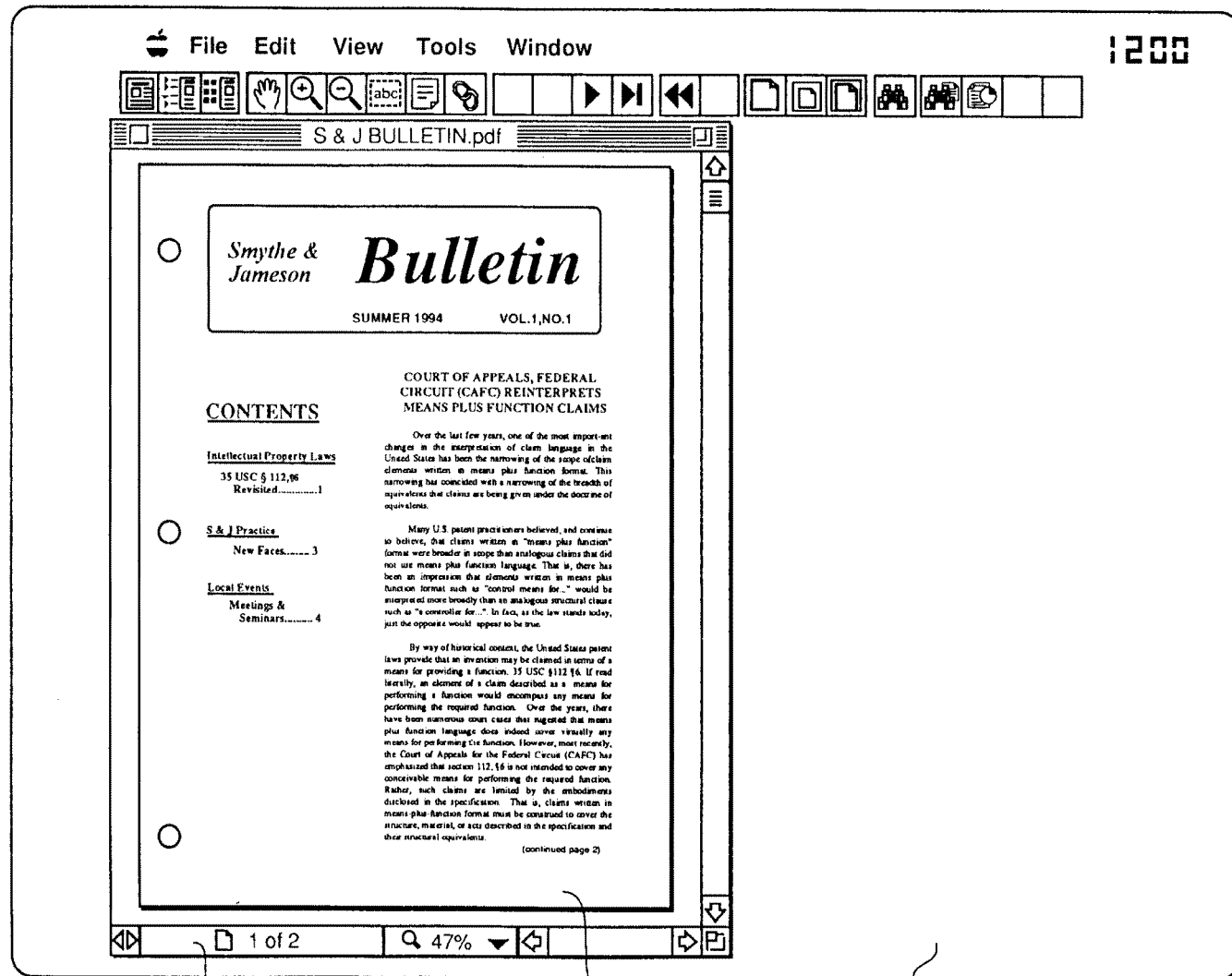



Fig. 3b



78

76

80

Fig. 3c

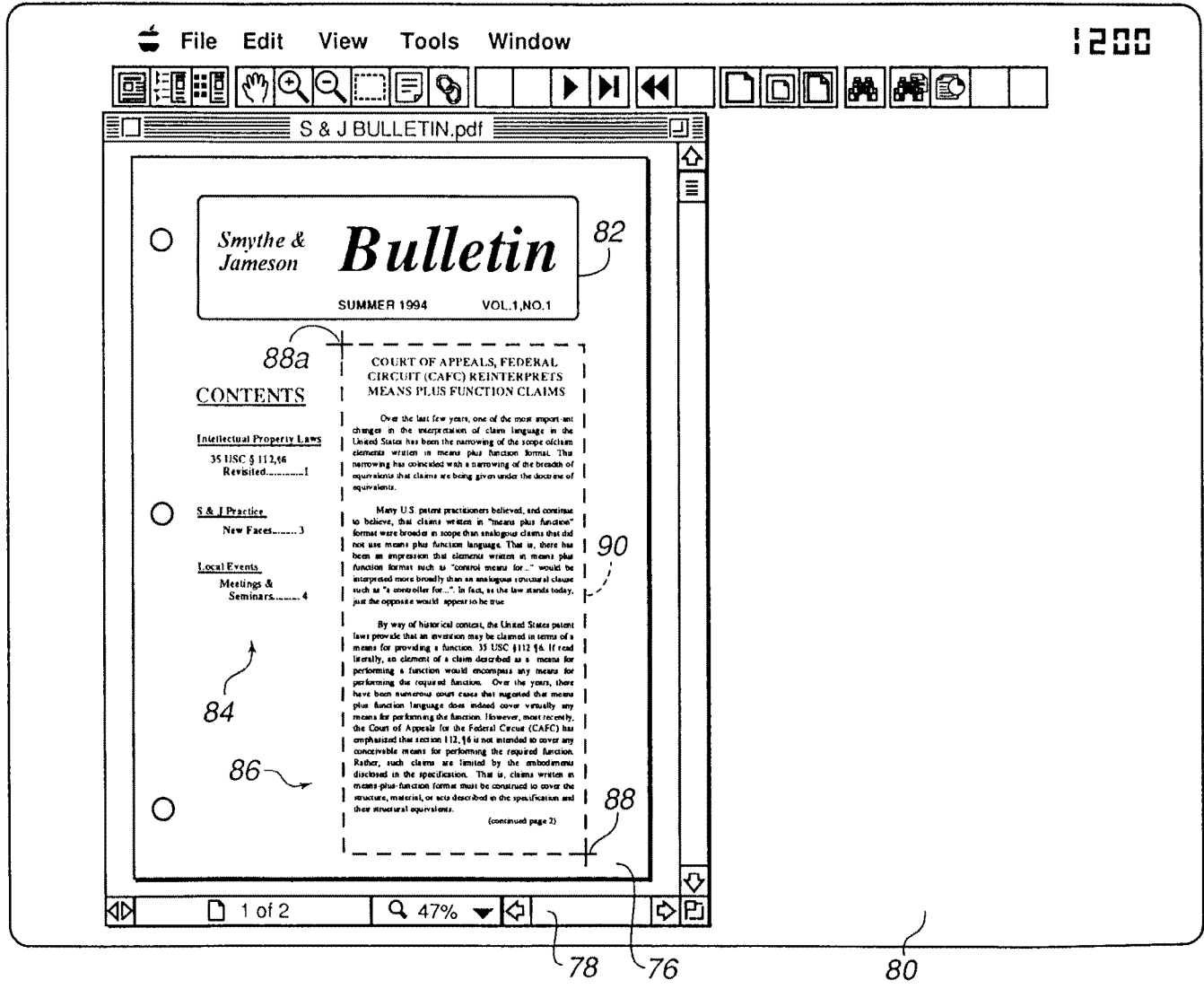

Fig. 3d

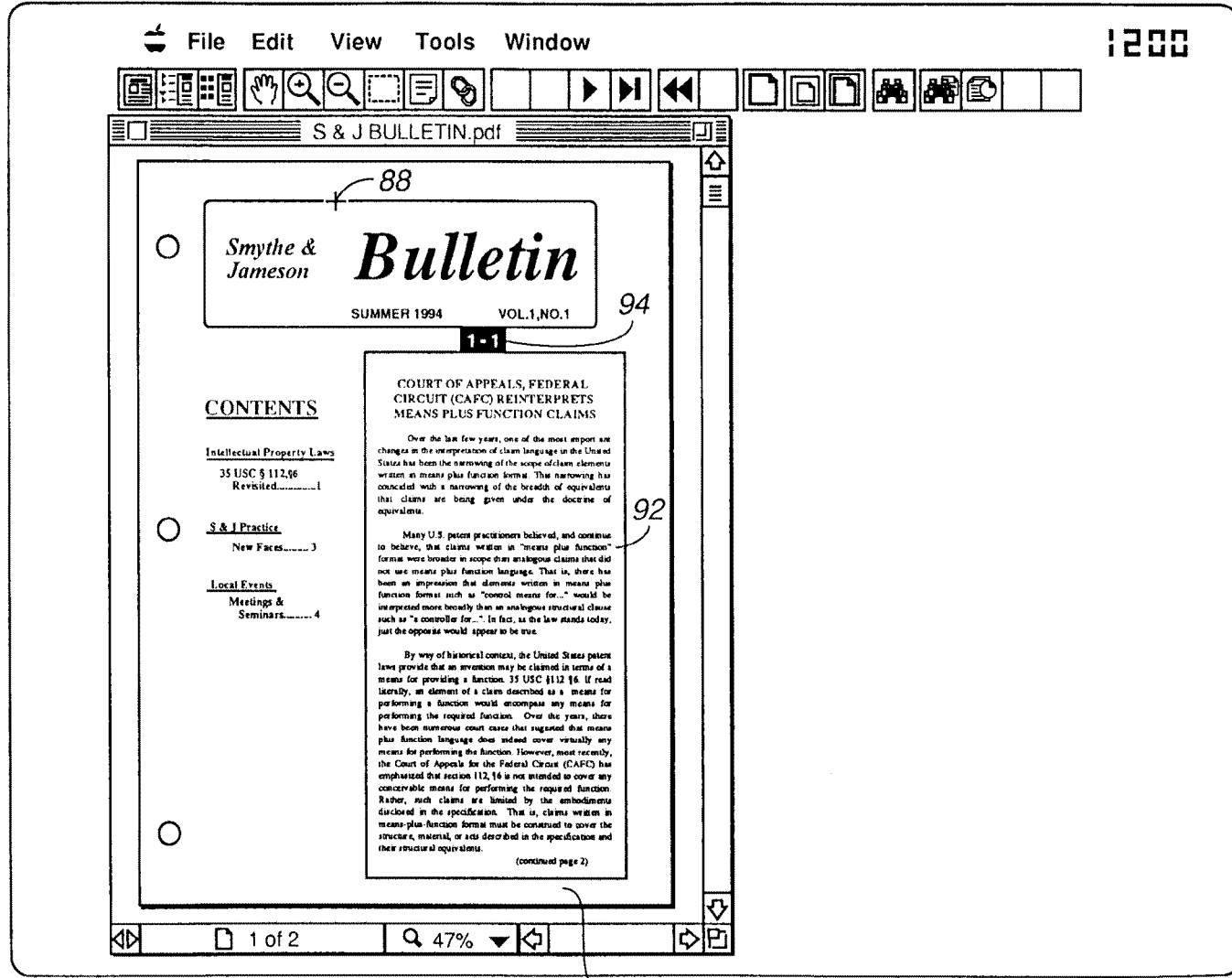

Fig. 3e

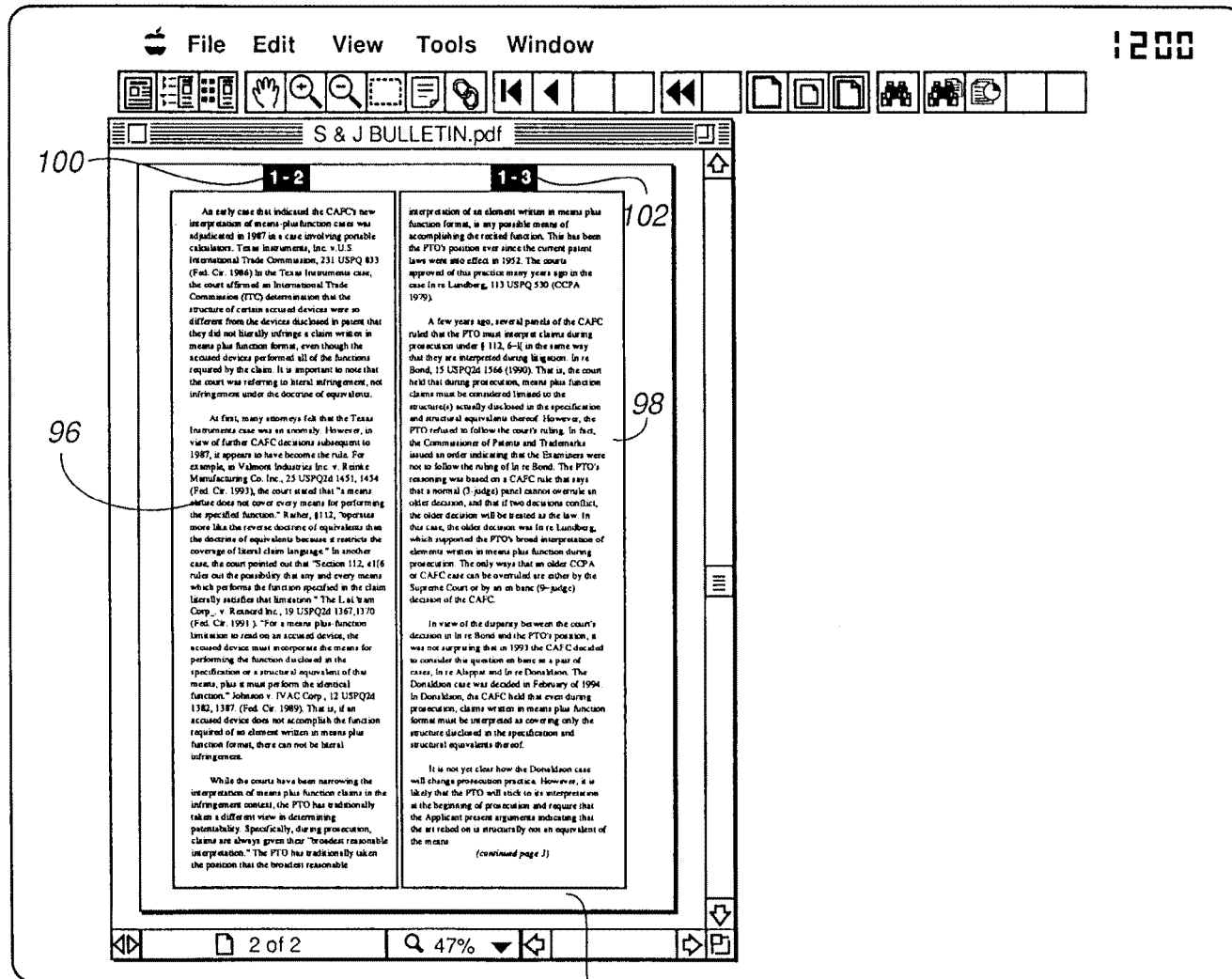
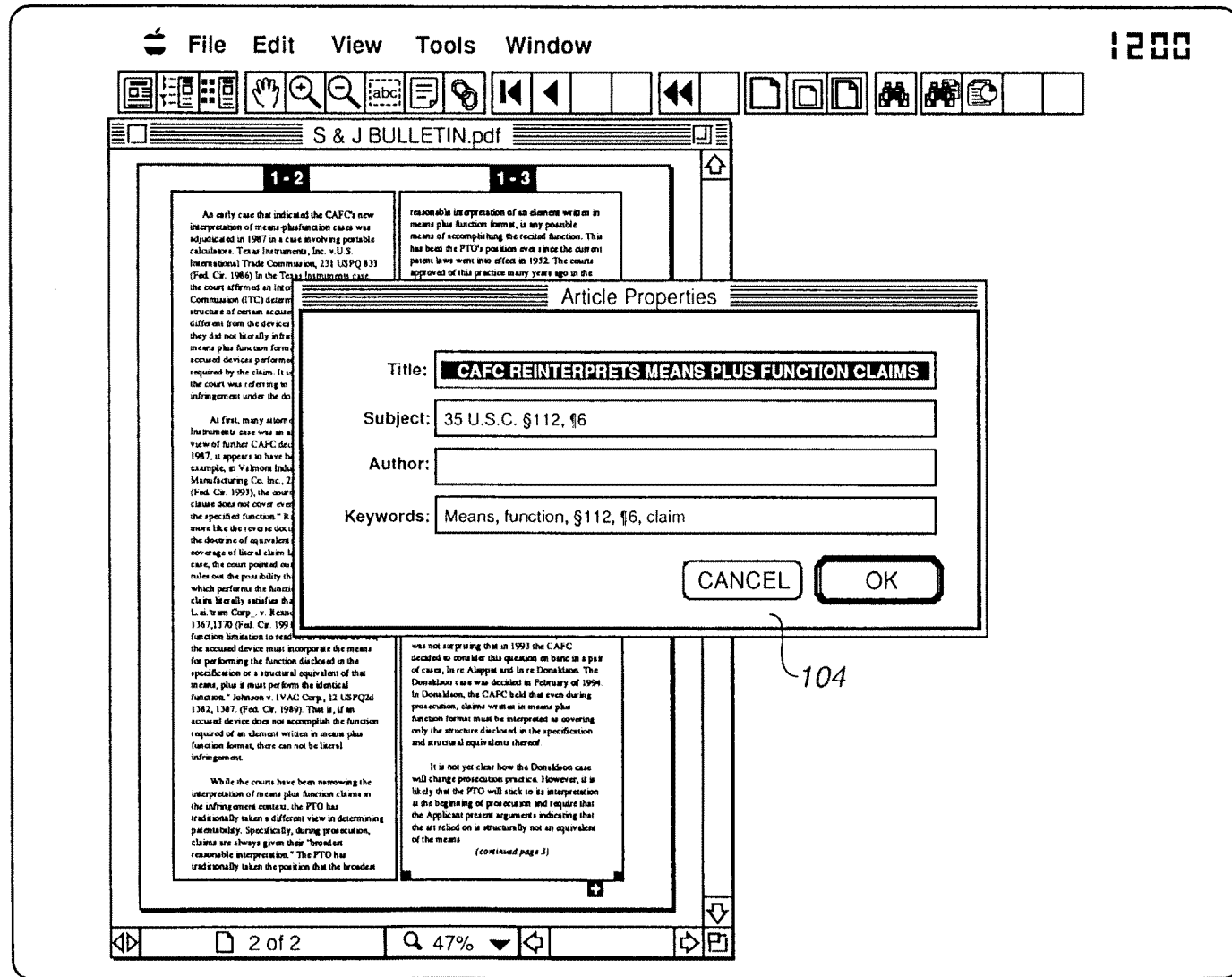

Fig. 3f



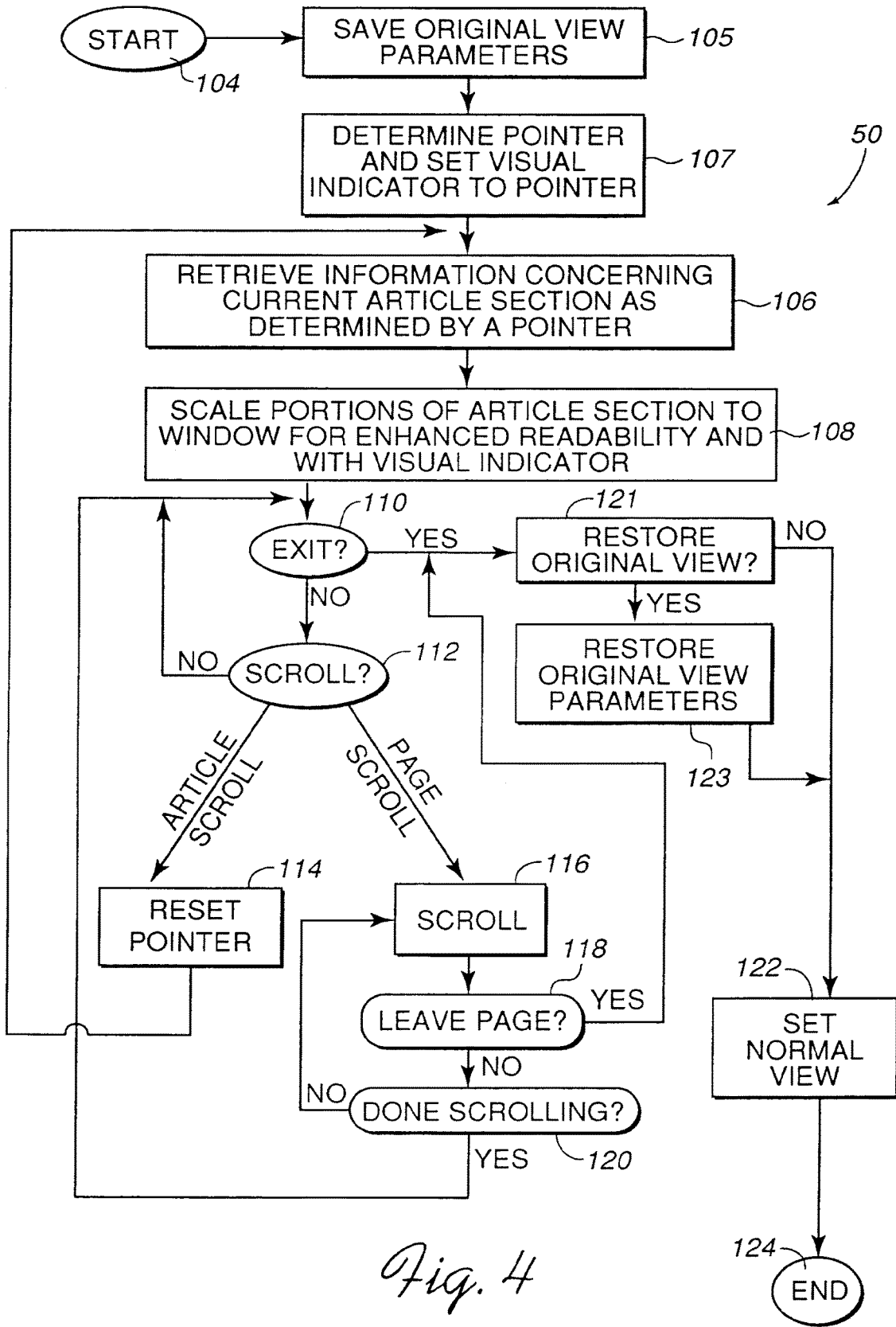
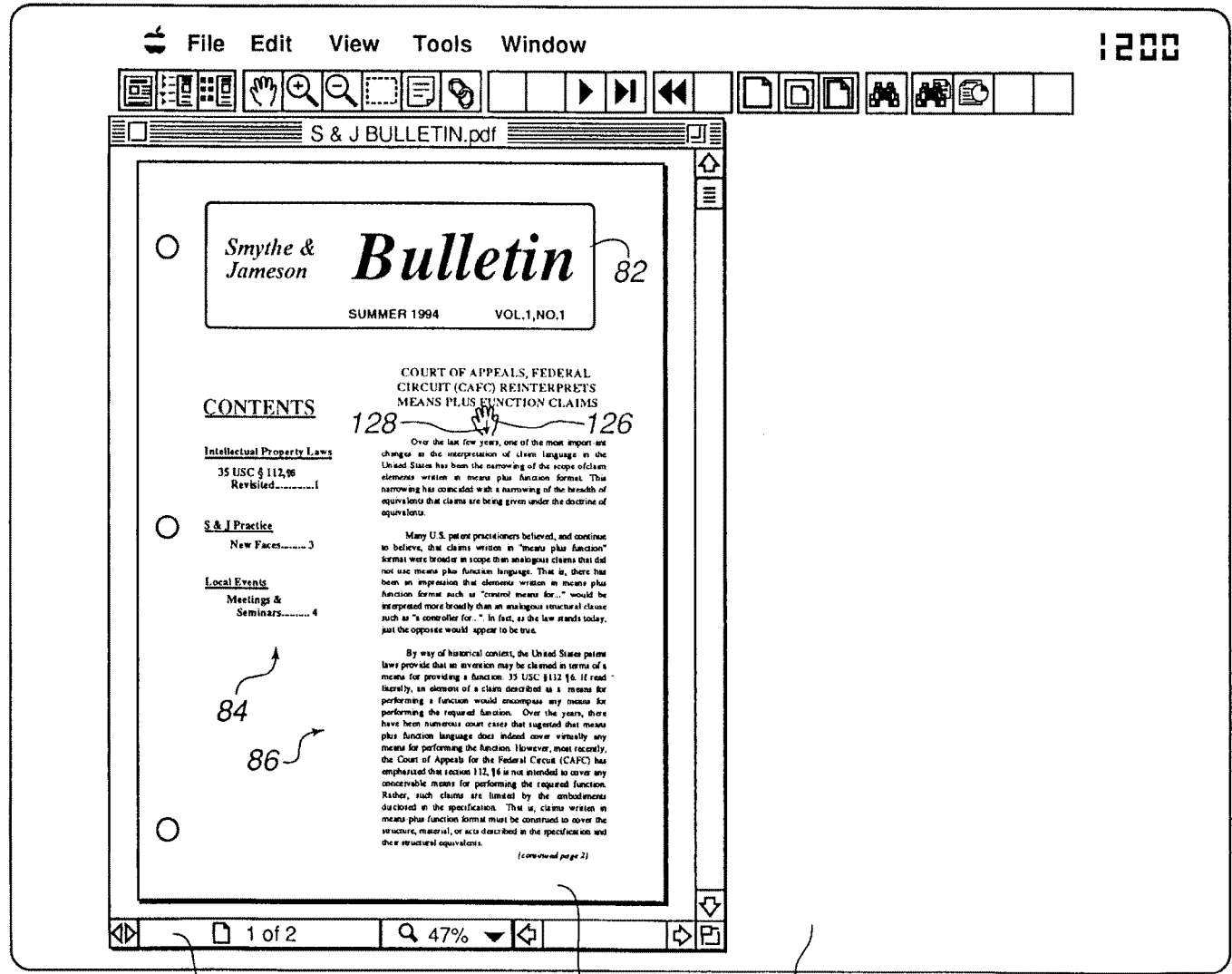

Fig. 4

Fig. 4a



84

86

82

78

76

80

Fig. 4b

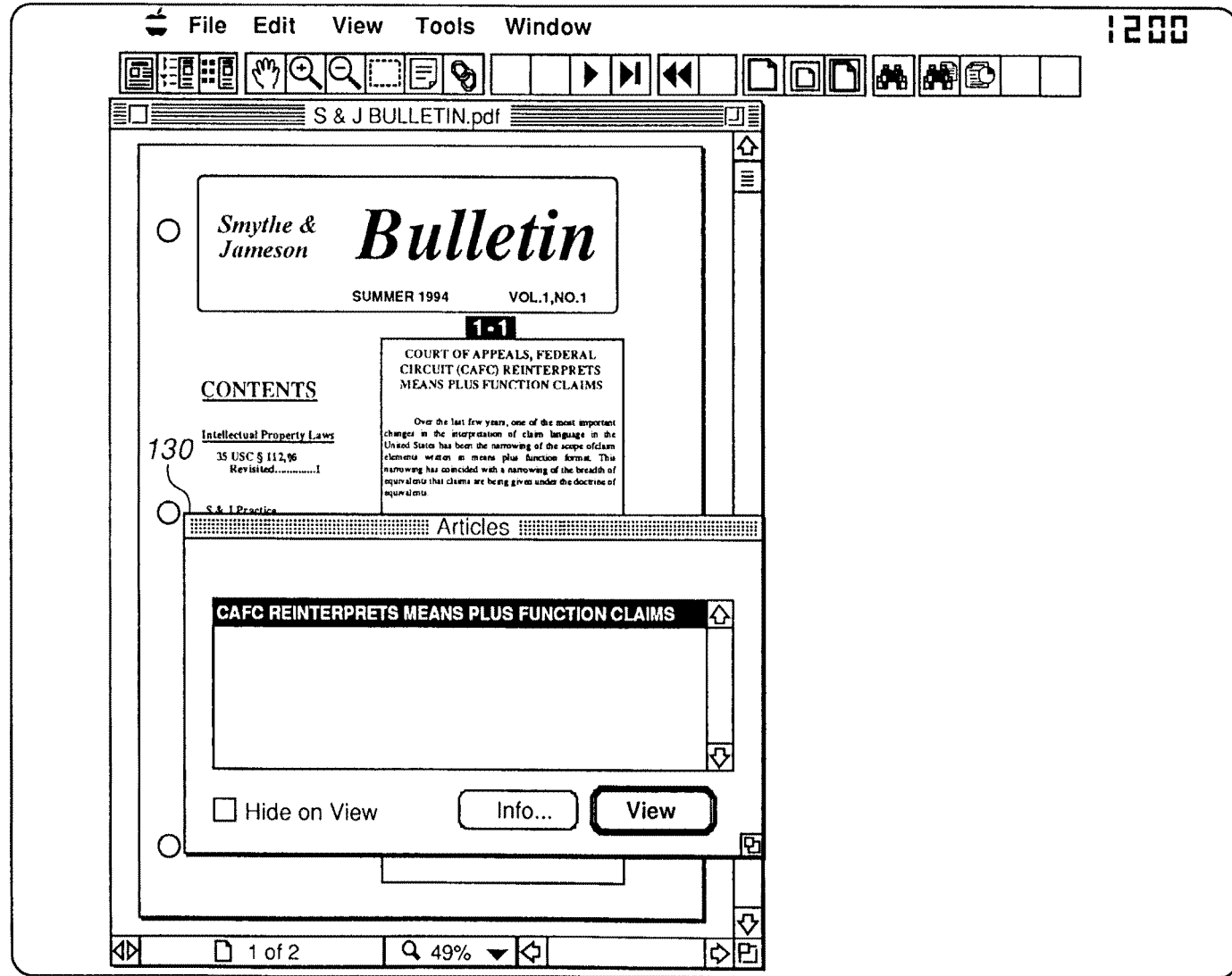



Fig. 4c

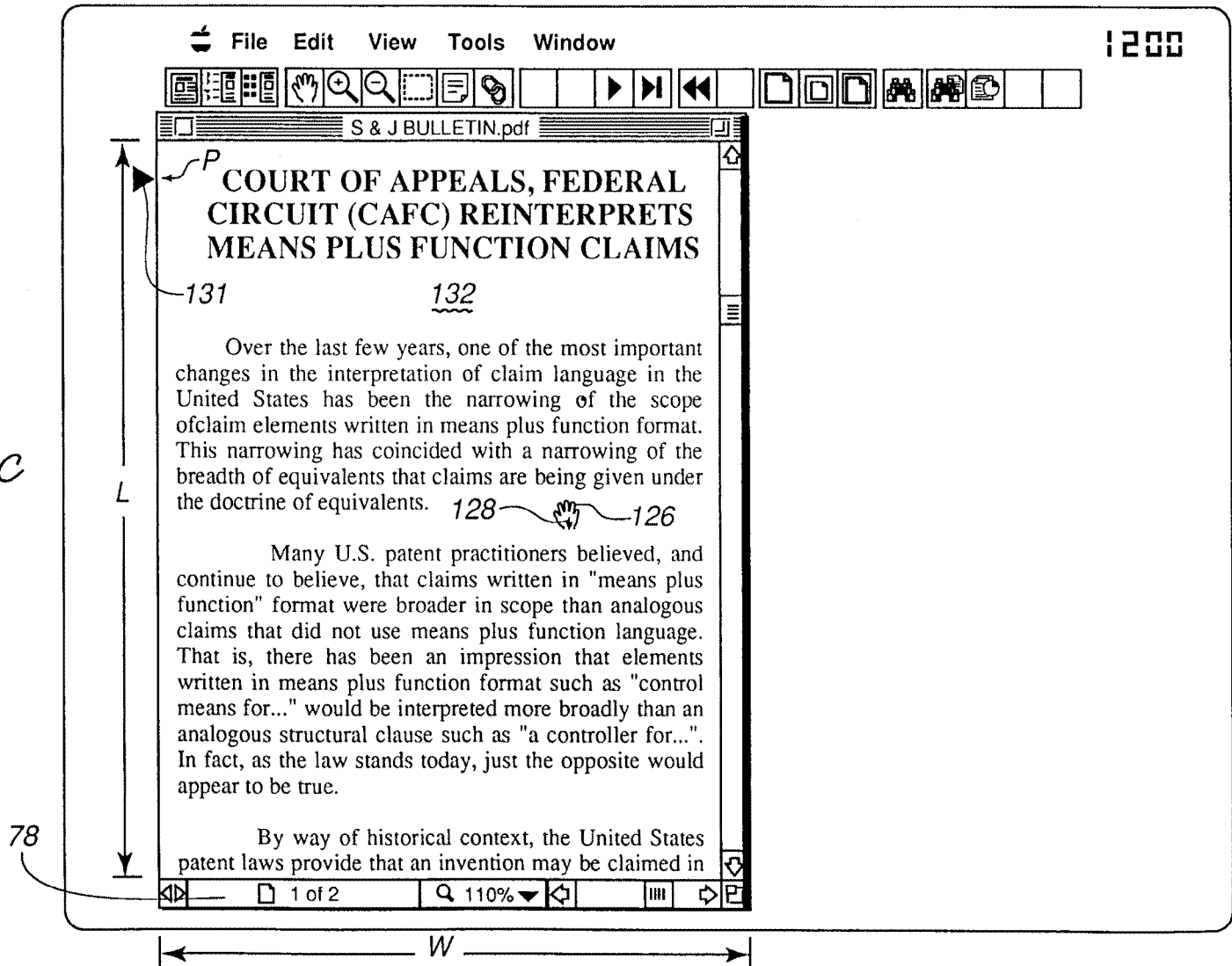

Fig. 4d

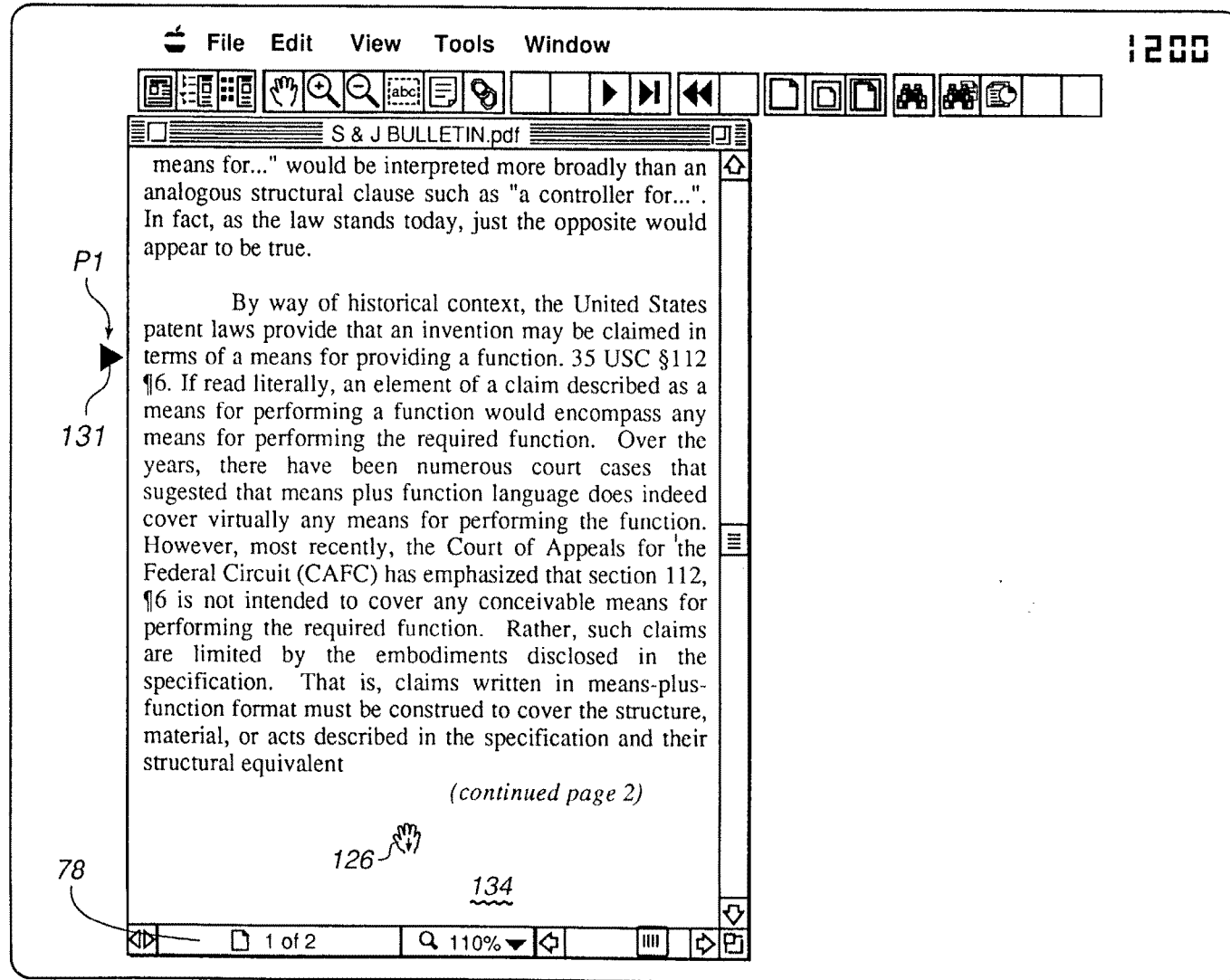

Fig. 4e

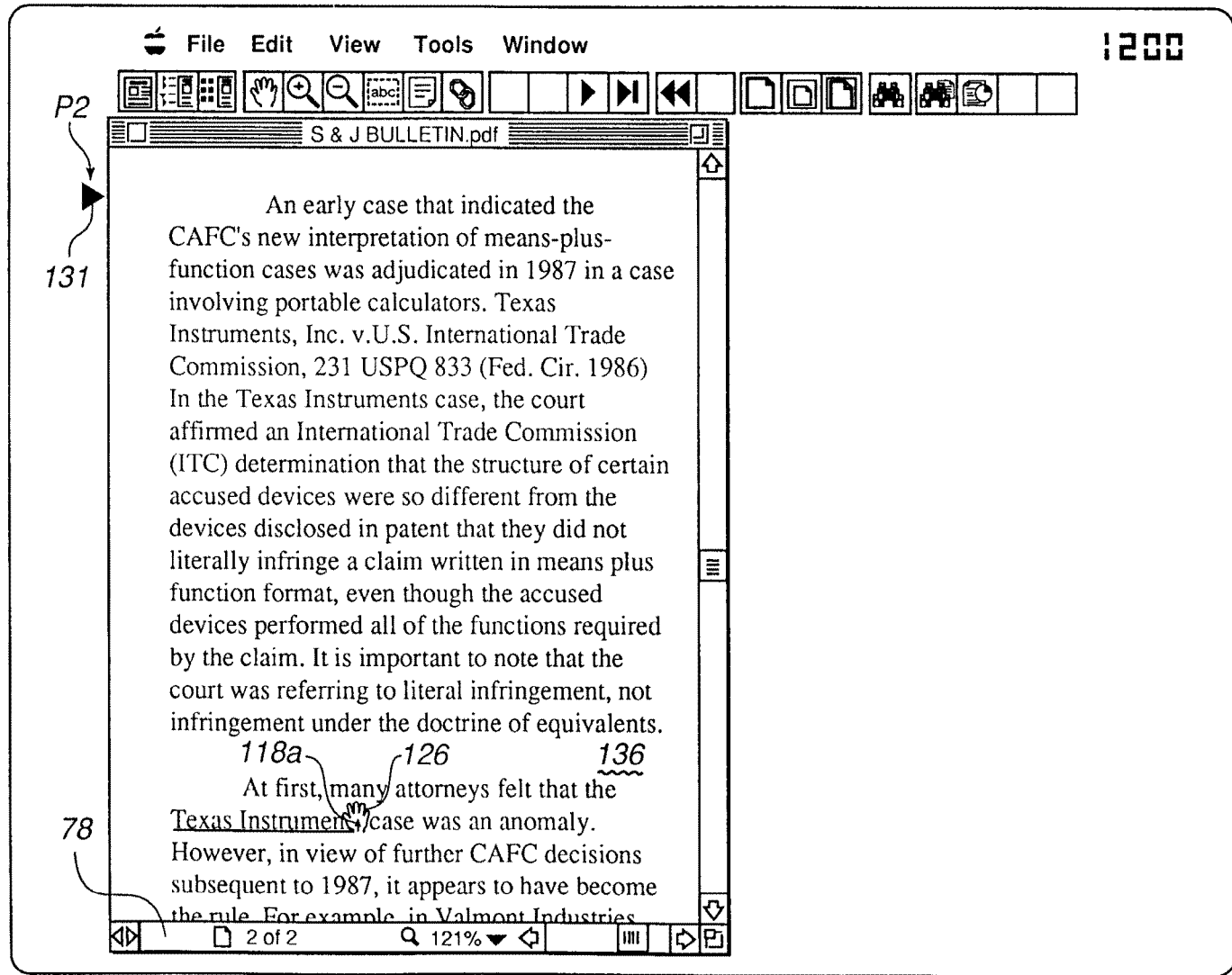

Fig. 5

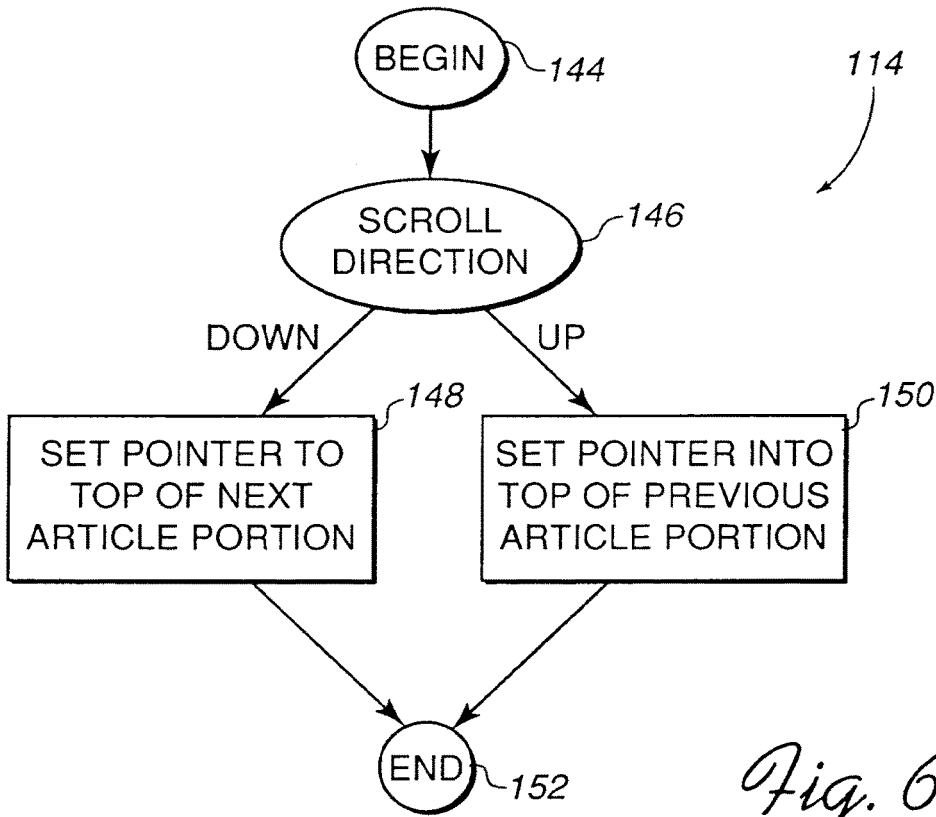
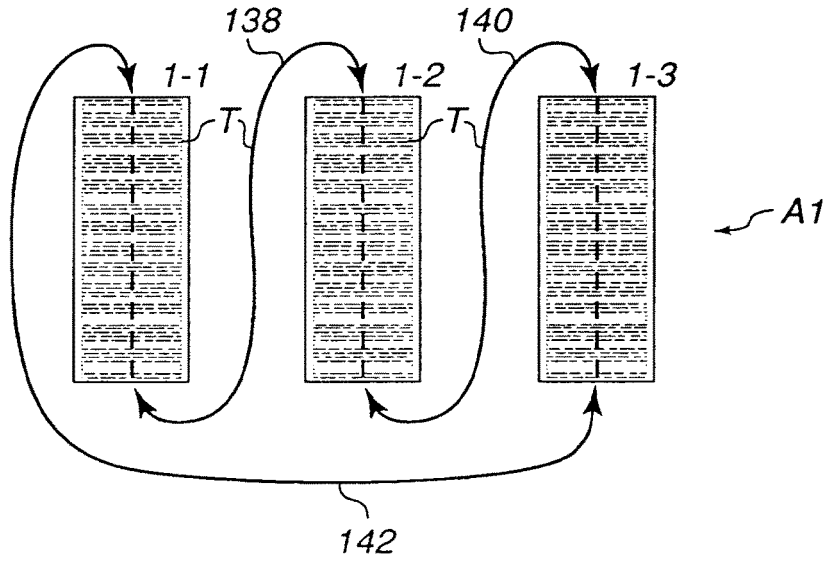

Fig. 6

148

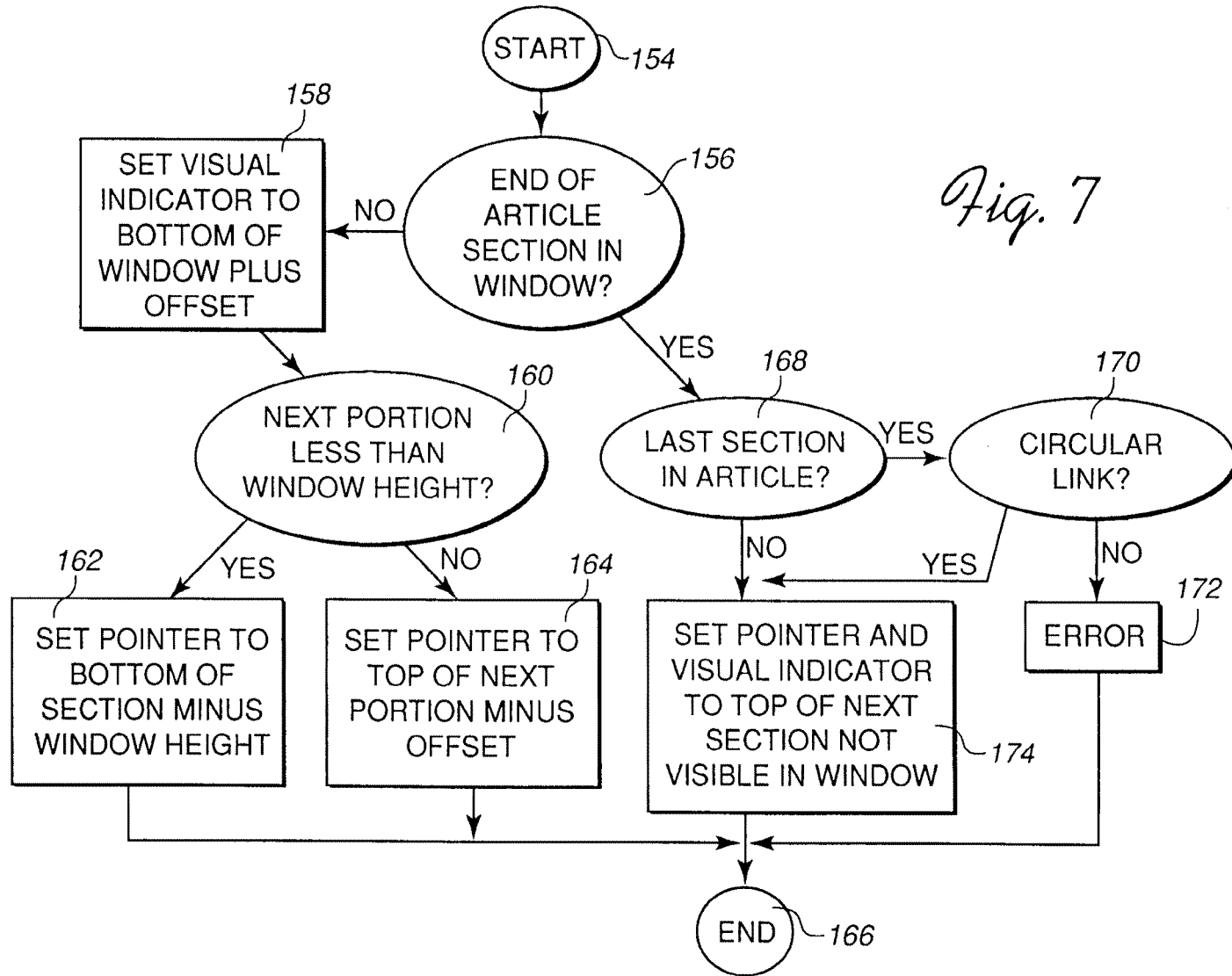

Fig. 7

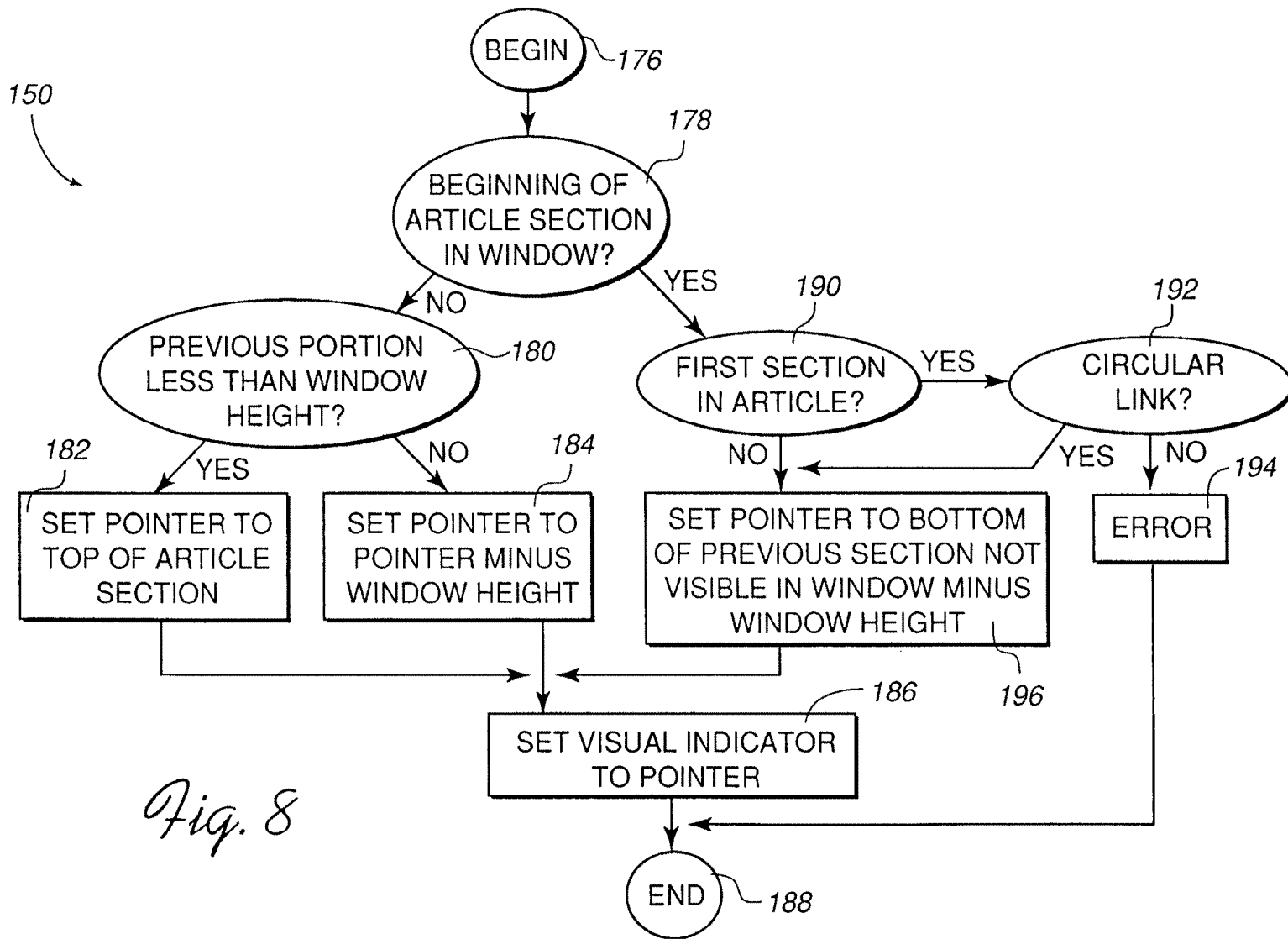

Fig. 8



European Patent  
Office

EUROPEAN SEARCH REPORT

Application Number  
EP 95 30 5286

DOCUMENTS CONSIDERED TO BE RELEVANT			
Category	Citation of document with indication, where appropriate, of relevant passages	Relevant to claim	CLASSIFICATION OF THE APPLICATION (Int.Cl.6)
A	COMPUTER GRAPHICS, vol. 28, no. 1, February 1994 pages 59-60, S. CUNNINGHAM 'Electronic Publishing with Adobe Acrobat' * page 59, left column, last paragraph - right column, paragraph 3 * * page 59, right column, paragraph 8 * ---	1-47	G06F17/21
A	COMPUTER COMMUNICATIONS, vol. 13, no. 4, May 1990 LONDON, GB, pages 243-249, NAJAH NAFFAH 'Multimedia applications' * page 245, right column, line 45 - page 246, left column, line 35 * ---	1-47	
A	ELECTRONIC PUBLISHING: ORIGINATION, DISSEMINATION AND DESIGN, vol. 6, no. 4, December 1993 UK, pages 481-493, P. N. SMITH ET AL 'Journal publishing with Acrobat: the CAJUN project' * the whole document * ---	1-47	TECHNICAL FIELDS SEARCHED (Int.Cl.6)
A	THE COMPUTER JOURNAL, vol. 32, no. 6, December 1989 CAMBRIDGE, CAMBS., GB, pages 482-493, D. F. BRAILSFORD ET AL 'Electronic Publishing - a Journal and its Production' * the whole document * -----	1-47	G06F
The present search report has been drawn up for all claims			
Place of search BERLIN		Date of completion of the search 18 December 1995	Examiner Abram, R
CATEGORY OF CITED DOCUMENTS		T : theory or principle underlying the invention E : earlier patent document, but published on, or after the filing date D : document cited in the application L : document cited for other reasons ----- & : member of the same patent family, corresponding document	
X : particularly relevant if taken alone Y : particularly relevant if combined with another document of the same category A : technological background O : non-written disclosure P : intermediate document			

EPO FORM 1503 03/92 (POMC01)

## WO05052773

Publication Title:

No title available

Abstract:

Abstract not available for WO05052773 Data supplied from the esp@cenet database - Worldwide

-----

Courtesy of <http://v3.espacenet.com>



(19) World Intellectual Property Organization  
International Bureau



(43) International Publication Date  
9 June 2005 (09.06.2005)

PCT

(10) International Publication Number  
WO 2005/052773 A2

- (51) International Patent Classification<sup>7</sup>: G06F 3/00
- (21) International Application Number: PCT/IB2004/003929
- (22) International Filing Date: 24 November 2004 (24.11.2004)
- (25) Filing Language: English
- (26) Publication Language: English
- (30) Priority Data: 10/723,283 26 November 2003 (26.11.2003) US
- (71) Applicant (for all designated States except US): NOKIA CORPORATION [FI/FI]; Keilalahdentie 4, FIN-02150 Espoo (FI).
- (72) Inventor; and
- (75) Inventor/Applicant (for US only): FABRITIUS, Henna [FI/FI]; Helenankatu 4 a 8, FIN-33100 Tampere (FI).
- (74) Agent: COHAUSZ & FLORACK (24); Bleichstrasse 14, 40211 Düsseldorf (DE).
- (81) Designated States (unless otherwise indicated, for every kind of national protection available): AE, AG, AL, AM, AT, AU, AZ, BA, BB, BG, BR, BW, BY, BZ, CA, CH, CN, CO, CR, CU, CZ, DE, DK, DM, DZ, EC, EE, EG, ES, FI, GB, GD, GE, GH, GM, HR, HU, ID, IL, IN, IS, JP, KE, KG, KP, KR, KZ, LC, LK, LR, LS, LT, LU, LV, MA, MD, MG, MK, MN, MW, MX, MZ, NA, NI, NO, NZ, OM, PG, PH, PL, PT, RO, RU, SC, SD, SE, SG, SK, SL, SY, TJ, TM, TN, TR, TT, TZ, UA, UG, US, UZ, VC, VN, YU, ZA, ZM, ZW.
- (84) Designated States (unless otherwise indicated, for every kind of regional protection available): ARIPO (BW, GH, GM, KE, LS, MW, MZ, NA, SD, SL, SZ, TZ, UG, ZM, ZW), Eurasian (AM, AZ, BY, KG, KZ, MD, RU, TJ, TM), European (AT, BE, BG, CH, CY, CZ, DE, DK, EE, ES, FI, FR, GB, GR, HU, IE, IS, IT, LU, MC, NL, PL, PT, RO, SE,

[Continued on next page]

(54) Title: CHANGING AN ORIENTATION OF A USER INTERFACE VIA A COURSE OF MOTION

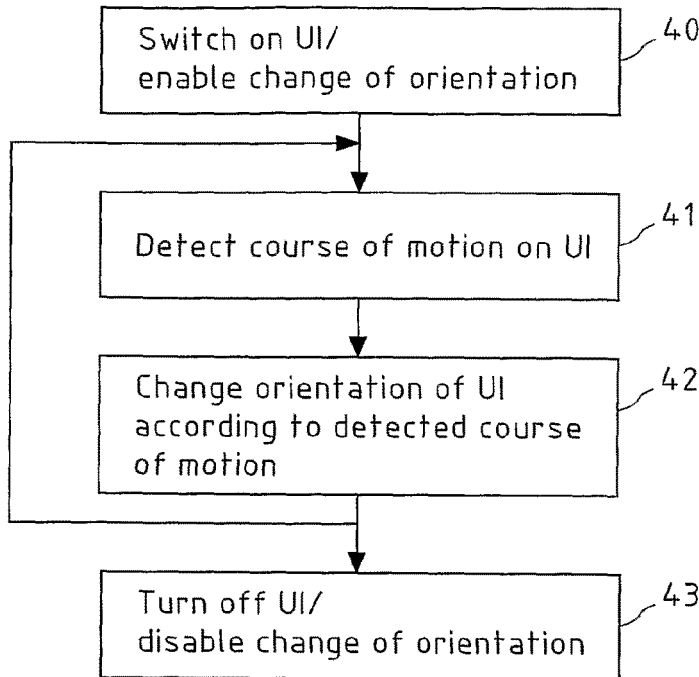

(57) Abstract: The invention relates to a method for changing an orientation of a User Interface (UI), the method comprises the steps of detecting a course of motion that is performed on the UI, and changing the orientation of the UI with respect to a device in which the UI is integrated according to the detected course of motion. The course of motion that is performed on the UI may for instance be the dragging of an element across a touch-screen display or the drawing of a gesture on a touch-screen display. The invention further relates to a device, a mobile phone, a computer program and a computer program product.

WO 2005/052773 A2



SI, SK, TR), OAPI (BF, BJ, CF, CG, CI, CM, GA, GN, GQ, GW, ML, MR, NE, SN, TD, TG).

*For two-letter codes and other abbreviations, refer to the "Guidance Notes on Codes and Abbreviations" appearing at the beginning of each regular issue of the PCT Gazette.*

**Published:**

— *without international search report and to be republished upon receipt of that report*

**Changing an Orientation of a User Interface  
Via a Course of Motion**

5

Field of the invention

The invention relates to a method for changing an orientation of a user interface.

10 

Background of the invention

The ongoing miniaturization of hand-held multi-media devices such as Personal Digital Assistants (PDAs) or mobile phones in recent years appears to be only bounded by the perceptual limits of the human user. This particularly applies to the design of the User Interfaces (UIs) of hand-held devices, such as for instance displays or touch-screen displays, with a remarkable trend to increase the relative area of the hand-held device that is consumed by its UI. Portrayal of content on such UIs can be further improved by allowing for a change of the orientation of the UI with respect to the hand-held device said UI is integrated in. Such a change of the orientation of the UI may for instance take the shape of a rotation of the UI with respect to the hand-held device, so that said hand-held device can for instance be used in both horizontal and vertical position.

When the orientation of a UI is changed, the logic that controls the UI has to be adapted to the change of orientation.

Fig. 1a exemplarily depicts a mobile phone 1 with a rectangular UI 2 of size  $a \times b$ . In the left figure of Fig. 1a, an image is displayed on the UI 2, for instance a snapshot taken by the user of a different mobile phone

and sent to the user of the mobile phone 1 via the  
Multimedia Messaging Service (MMS). To view the snapshot  
properly, either the user of mobile phone 1 would have to  
rotate his mobile phone 1 by 90° clockwise, or the  
5 orientation of the UI would have to be rotated by 90°  
clockwise, as depicted in the right figure of Fig. 1a.  
Such a rotation of the orientation of the UI can be  
initiated by the user by pressing a key 3 on his mobile  
phone 1 or by browsing through the menu of his mobile  
10 phone 1 to find the menu option that allows for the  
rotation of the UI orientation. Rotation of the  
orientation of the UI 2 is performed in software, for  
instance by the UI controller of the mobile phone 1.

15 Fig. 1b shows a second example of improved portrayal of  
images on a UI 2 of a mobile phone 1 when rotating the  
orientation of the UI 2. A typical landscape image is to  
be viewed on the UI 2 of the mobile phone 1 as shown in  
the left figure of Fig. 1b. Due to the limited width of  
20 the UI 2, the landscape image is either re-sized to fit  
the width b of the UI 2, as shown in the upper left  
figure of Fig. 1b, or only a part of the entire image is  
displayed on the UI 2 by fitting the height of the image  
to the height of the display and inserting a scroll bar  
25 4, so that the remaining parts on the right side of the  
image can be explored by the user of the mobile phone 1  
by scrolling (see the lower left figure of Fig. 1b).  
Portrayal is improved by rotating the orientation of the  
UI 2 by 90° clockwise, for instance by pressing a key 3  
30 of the mobile phone 1, that switches between portrait  
orientation (as on the left of Fig. 1b) and landscape  
orientation (as on the right of Fig. 1b). The full-size

image then can be viewed under optimum exploitation of the dimensions of the UI 2.

In prior art devices, the orientation of a UI can be  
5 changed by pressing a hard key of the device, for  
instance a portrait/landscape key 3 as in the example of  
Fig. 1b. However, due to the limited size of hand-held  
devices, additional hard keys are generally difficult to  
10 place on the device, and assigning an already existing  
hard key additional functionality, for instance that the  
hard key has to be pressed for a longer duration to call  
the additional functionality, may distract the user of  
the device.

15 In further prior art, the change of the orientation of  
the UI is implemented as a menu option of a display menu.  
The user of the device then has to browse the devices  
menu and find the corresponding entry in order to change  
the orientation of the UI, which is a time-consuming and  
20 annoying task especially when the orientation of a UI has  
to be frequently changed. Furthermore, the unskilled user  
of the device may not be aware of the possibility to  
change the orientation of the UI or may get lost in the  
menu when searching for it.

25

A further prior art approach to cause the change of the  
orientation of a UI uses motion sensors in the device to  
determine if the device itself is rotated by a user. For  
instance, in the example of Fig. 1b, when the user  
30 rotates the mobile phone 1 with the image being displayed  
according to the upper or lower left figure by 90°  
clockwise, the rotation is sensed by the mobile phone 1,

and the orientation of the UI 2 is automatically switched from portrait mode to landscape mode (see the right figure of Fig. 1b), without any further user interaction like pressing a hard key or similar. This approach, however, deprives the user of his freedom to choose in which orientation of the UI 2 he prefers to watch an image. Furthermore, this method may become unstable in a mobile environment where the mobile phone 1 is subject to frequent relocation and shocks.

10

#### Summary of the invention

It is proposed that a method for changing an orientation of a UI comprises detecting a course of motion that is performed on said UI, and changing said orientation of said UI with respect to the device said UI is integrated in according to said detected course of motion.

Said UI may for instance be a display or touch-screen display of a hand-held device. The orientation of said UI with respect to said device can be changed, for instance by rotating the UI with respect to said device. If said UI is a touch-screen display, then the complete display and input control logic is rotated. The method according to the present invention then allows a user of said device to use said device for instance in vertical and horizontal mode for both viewing content and for operating the touch-screen display. Said course of motion may be performed on said UI by a user of said device the UI is integrated in. Said course of motion is detected, and said orientation of said UI is changed according to said detected course of motion. For instance, if said course of motion is a part of a circle that is drawn on a

20  
25  
30

touch-screen display with a stylus, the length of the circle may be indicative of the angle by which the UI orientation is to be changed. For instance, a half circle may initiate the rotation of the UI orientation by 180°,  
5 so that content is displayed upside-down on said UI.

According to a method of the present invention, said course of motion is performed on said UI via a UI interaction device. The user of the device into which  
10 said UI is integrated may require such a UI interaction device to perform the course of motion on said UI.

According to a method of the present invention, said UI is a touch-screen display and said UI interaction device  
15 is a touching device, in particular a stylus. Said touching device may equally well be the finger tip of a user. In addition to its text, image and/or video presentation capabilities, said touch-screen display may be capable of detecting courses of motion that are drawn  
20 or written on said display as if the display was a sheet of paper, and may be of resistive, capacitive or surface wave type. Said courses of motion may for instance be lines, characters, symbols, or a simple selection of designated areas of said touch-screen-display.

25  
According to a method of the present invention, said UI interaction device is a device that controls the movement of an element on said UI, in particular a track-ball or a joystick. Said element being displayed on said UI may for  
30 instance be an arrow or a dot that is used for drawing or handwriting.