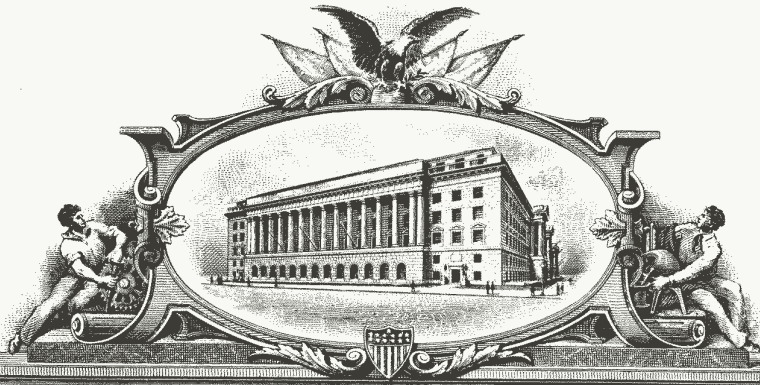

EXHIBIT 4.01

IW 7293892



THE UNITED STATES OF AMERICA

TO ALL TO WHOM THESE PRESENTS SHALL COME:

UNITED STATES DEPARTMENT OF COMMERCE
United States Patent and Trademark Office

May 09, 2011

THIS IS TO CERTIFY THAT ANNEXED IS A TRUE COPY FROM THE
RECORDS OF THIS OFFICE OF THE FILE WRAPPER AND CONTENTS
OF:

APPLICATION NUMBER: *11/677,958*

FILING DATE: *February 22, 2007*

PATENT NUMBER: *7,812,828*

ISSUE DATE: *October 12, 2010*

By Authority of the
Under Secretary of Commerce for Intellectual Property
and Director of the United States Patent and Trademark Office



M. TARVER
Certifying Officer

Under the Paperwork Reduction Act of 1995, no persons are required to respond to a collection of information unless it contains a valid OMB control number.

Application Data Sheet 37 CFR 1.76		Attorney Docket Number	119-0092USCD
		Application Number	
Title of Invention	Ellipse Fitting for Multi-Touch Surfaces		
<p>The application data sheet is part of the provisional or nonprovisional application for which it is being submitted. The following form contains the bibliographic data arranged in a format specified by the United States Patent and Trademark Office as outlined in 37 CFR 1.76.</p> <p>This document may be completed electronically and submitted to the Office in electronic format using the Electronic Filing System (EFS) or the document may be printed and included in a paper filed application.</p>			

Secrecy Order 37 CFR 5.2

- Portions or all of the application associated with this Application Data Sheet may fall under a Secrecy Order pursuant to 37 CFR 5.2 (Paper filers only. Applications that fall under Secrecy Order may not be filed electronically.)

Applicant Information:

Applicant 1						Remove
Applicant Authority		<input checked="" type="radio"/> Inventor		<input type="radio"/> Legal Representative under 35 U.S.C. 117		<input type="radio"/> Party of Interest under 35 U.S.C. 118
Prefix	Given Name	Middle Name	Family Name		Suffix	
	Wayne		Westerman			
Residence Information (Select One)						
		<input checked="" type="radio"/> US Residency		<input type="radio"/> Non US Residency		<input type="radio"/> Active US Military Service
City	San Francisco	State/Province	CA	Country of Residence i	US	
Citizenship under 37 CFR 1.41(b) i		US				
Mailing Address of Applicant:						
Address 1	260 King Street, Apt. 1507					
Address 2						
City	San Francisco		State/Province	CA		
Postal Code	64097	Countryi	US			
Applicant 2						Remove
Applicant Authority		<input checked="" type="radio"/> Inventor		<input type="radio"/> Legal Representative under 35 U.S.C. 117		<input type="radio"/> Party of Interest under 35 U.S.C. 118
Prefix	Given Name	Middle Name	Family Name		Suffix	
	John	G.	Elias			
Residence Information (Select One)						
		<input checked="" type="radio"/> US Residency		<input type="radio"/> Non US Residency		<input type="radio"/> Active US Military Service
City	Townsend	State/Province	DE	Country of Residence i	US	
Citizenship under 37 CFR 1.41(b) i		US				
Mailing Address of Applicant:						
Address 1	Huguenot Farm					
Address 2	798 Taylors Bridge Road					
City	Townsend		State/Province	DE		
Postal Code	19734	Countryi	US			
All Inventors Must Be Listed - Additional Inventor Information blocks may be generated within this form by selecting the Add button.						Add

Correspondence Information:

Enter either Customer Number or complete the Correspondence Information section below.
For further information see 37 CFR 1.33(a).

- An Address is being provided for the correspondence Information of this application.

Application Data Sheet 37 CFR 1.76		Attorney Docket Number	119-0092USCD	
		Application Number		
Title of Invention	Ellipse Fitting for Multi-Touch Surfaces			
Customer Number	29855			
Email Address	WCpatent@counselip.com	<input type="button" value="Add Email"/>	<input type="button" value="Remove Email"/>	

Application Information:

Title of the Invention	Ellipse Fitting for Multi-Touch Surfaces			
Attorney Docket Number	119-0092USCD	Small Entity Status Claimed <input type="checkbox"/>		
Application Type	Nonprovisional			
Subject Matter	Utility			
Suggested Class (if any)		Sub Class (if any)		
Suggested Technology Center (if any)				
Total Number of Drawing Sheets (if any)	45	Suggested Figure for Publication (if any)		
Publication Information:				
<input type="checkbox"/> Request Early Publication (Fee required at time of Request 37 CFR 1.219)				
<input type="checkbox"/> Request Not to Publish. I hereby request that the attached application not be published under 35 U.S.C. 122(b) and certify that the invention disclosed in the attached application has not been and will not be the subject of an application filed in another country, or under a multilateral agreement, that requires publication at eighteen months after filing.				

Representative Information:

Representative information should be provided for all practitioners having a power of attorney in the application. Providing this information in the Application Data Sheet does not constitute a power of attorney in the application (see 37 CFR 1.32). Enter either Customer Number or complete the Representative Name section below. If both sections are completed the Customer Number will be used for the Representative Information during processing.			
Please Select One:	<input checked="" type="radio"/> Customer Number	<input type="radio"/> US Patent Practitioner	<input type="radio"/> US Representative (37 CFR 11.9)
Customer Number	29855		

Domestic Priority Information:

This section allows for the applicant to claim benefit under 35 U.S.C. 119(e), 120, 121, or 365(c). Providing this information in the application data sheet constitutes the specific reference required by 35 U.S.C. 119(e) or 120, and 37 CFR 1.78(a)(2) or CFR 1.78(a)(4), and need not otherwise be made part of the specification.					
Prior Application Status	Pending		<input type="button" value="Remove"/>		
Application Number	Continuity Type	Prior Application Number	Filing Date (YYYY-MM-DD)		
11015434	Continuation of	0923615	2004-12-17		
Prior Application Status	Patented		<input type="button" value="Remove"/>		
Application Number	Continuity Type	Prior Application Number	Filing Date (YYYY-MM-DD)	Patent Number	Issue Date (YYYY-MM-DD)
09236513	Continuation of	60072509	1999-01-25	6323846	2001-11-27

Under the Paperwork Reduction Act of 1995, no persons are required to respond to a collection of information unless it contains a valid OMB control number.

Application Data Sheet 37 CFR 1.76	Attorney Docket Number	119-0092USCD
	Application Number	
Title of Invention	Ellipse Fitting for Multi-Touch Surfaces	

Additional Domestic Priority Data may be generated within this form by selecting the **Add** button.

Foreign Priority Information:

This section allows for the applicant to claim benefit of foreign priority and to identify any prior foreign application for which priority is not claimed. Providing this information in the application data sheet constitutes the claim for priority as required by 35 U.S.C. 119(b) and 37 CFR 1.55(a).

Application Number	Country ⁱ	Parent Filing Date (YYYY-MM-DD)	Priority Claimed
			<input checked="" type="radio"/> Yes <input type="radio"/> No

Additional Foreign Priority Data may be generated within this form by selecting the **Add** button.

Assignee Information:

Providing this information in the application data sheet does not substitute for compliance with any requirement of part 3 of Title 37 of the CFR to have an assignment recorded in the Office.

Assignee 1

If the Assignee is an Organization check here.

Organization Name Fingerworks, Inc.

Mailing Address Information:

Address 1 20333 SH 249, Suite 600

Address 2

City Houston State/Province TX

Country ⁱ US Postal Code 77070

Phone Number Fax Number

Email Address

Additional Assignee Data may be generated within this form by selecting the **Add** button.

Signature:

A signature of the applicant or representative is required in accordance with 37 CFR 1.33 and 10.18. Please see 37 CFR 1.4(d) for the form of the signature.

Signature	//Billy C. Allen III//		Date (YYYY-MM-DD)	2007-02-22	
First Name	Billy	Last Name	Allen	Registration Number	46147

Under the Paperwork Reduction Act of 1995, no persons are required to respond to a collection of information unless it contains a valid OMB control number.

Application Data Sheet 37 CFR 1.76	Attorney Docket Number	119-0092USCD
	Application Number	
Title of Invention	Ellipse Fitting for Multi-Touch Surfaces	

This collection of information is required by 37 CFR 1.76. The information is required to obtain or retain a benefit by the public which is to file (and by the USPTO to process) an application. Confidentiality is governed by 35 U.S.C. 122 and 37 CFR 1.14. This collection is estimated to take 23 minutes to complete, including gathering, preparing, and submitting the completed application data sheet form to the USPTO. Time will vary depending upon the individual case. Any comments on the amount of time you require to complete this form and/or suggestions for reducing this burden, should be sent to the Chief Information Officer, U.S. Patent and Trademark Office, U.S. Department of Commerce, P.O. Box 1450, Alexandria, VA 22313-1450. DO NOT SEND FEES OR COMPLETED FORMS TO THIS ADDRESS. **SEND TO: Commissioner for Patents, P.O. Box 1450, Alexandria, VA 22313-1450.**

Privacy Act Statement

The Privacy Act of 1974 (P.L. 93-579) requires that you be given certain information in connection with your submission of the attached form related to a patent application or patent. Accordingly, pursuant to the requirements of the Act, please be advised that: (1) the general authority for the collection of this information is 35 U.S.C. 2(b)(2); (2) furnishing of the information solicited is voluntary; and (3) the principal purpose for which the information is used by the U.S. Patent and Trademark Office is to process and/or examine your submission related to a patent application or patent. If you do not furnish the requested information, the U.S. Patent and Trademark Office may not be able to process and/or examine your submission, which may result in termination of proceedings or abandonment of the application or expiration of the patent.

The information provided by you in this form will be subject to the following routine uses:

1. The information on this form will be treated confidentially to the extent allowed under the Freedom of Information Act (5 U.S.C. 552) and the Privacy Act (5 U.S.C. 552a). Records from this system of records may be disclosed to the Department of Justice to determine whether the Freedom of Information Act requires disclosure of these records.
2. A record from this system of records may be disclosed, as a routine use, in the course of presenting evidence to a court, magistrate, or administrative tribunal, including disclosures to opposing counsel in the course of settlement negotiations.
3. A record in this system of records may be disclosed, as a routine use, to a Member of Congress submitting a request involving an individual, to whom the record pertains, when the individual has requested assistance from the Member with respect to the subject matter of the record.
4. A record in this system of records may be disclosed, as a routine use, to a contractor of the Agency having need for the information in order to perform a contract. Recipients of information shall be required to comply with the requirements of the Privacy Act of 1974, as amended, pursuant to 5 U.S.C. 552a(m).
5. A record related to an International Application filed under the Patent Cooperation Treaty in this system of records may be disclosed, as a routine use, to the International Bureau of the World Intellectual Property Organization, pursuant to the Patent Cooperation Treaty.
6. A record in this system of records may be disclosed, as a routine use, to another federal agency for purposes of National Security review (35 U.S.C. 181) and for review pursuant to the Atomic Energy Act (42 U.S.C. 218(c)).
7. A record from this system of records may be disclosed, as a routine use, to the Administrator, General Services, or his/her designee, during an inspection of records conducted by GSA as part of that agency's responsibility to recommend improvements in records management practices and programs, under authority of 44 U.S.C. 2904 and 2906. Such disclosure shall be made in accordance with the GSA regulations governing inspection of records for this purpose, and any other relevant (i.e., GSA or Commerce) directive. Such disclosure shall not be used to make determinations about individuals.
8. A record from this system of records may be disclosed, as a routine use, to the public after either publication of the application pursuant to 35 U.S.C. 122(b) or issuance of a patent pursuant to 35 U.S.C. 151. Further, a record may be disclosed, subject to the limitations of 37 CFR 1.14, as a routine use, to the public if the record was filed in an application which became abandoned or in which the proceedings were terminated and which application is referenced by either a published application, an application open to public inspections or an issued patent.
9. A record from this system of records may be disclosed, as a routine use, to a Federal, State, or local law enforcement agency, if the USPTO becomes aware of a violation or potential violation of law or regulation.

COMBINED DECLARATION AND POWER OF ATTORNEY

Attorney Docket No. 131*170

As a below named inventor, I hereby declare that:

My residence, post office address and citizenship are as stated below next to my name,

I believe I am the original, first and sole inventor (if only one name is listed below) or an original, first and joint inventor (if plural names are listed below) of subject matter which is claimed and for which a patent is sought on the invention entitled **METHOD AND APPARATUS FOR INTEGRATING MANUAL INPUT** the specification is attached hereto.

I hereby state that I have reviewed and understand the contents of the above-identified specification, including the claims, as amended by any amendment referred to above.

I acknowledge the duty to disclose to the Office all information known to me to be material to patentability as defined in Title 37, Code of Federal Regulations, § 1.56.

I hereby claim foreign priority benefits under Title 35, United States Code, § 119 of any foreign application(s) for patent or inventor's certificate listed below and have also identified below any foreign application for patent or inventor's certificate having a filing date before that of the application on which priority is claimed:

Prior Foreign Application(s)

Priority Claimed

(Number)	(Country)	(Day/Month/Year Filed)	Yes	No
_____	_____	_____	<input type="checkbox"/>	<input type="checkbox"/>
_____	_____	_____	<input type="checkbox"/>	<input type="checkbox"/>

I hereby claim the benefit under Title 35, United States Code, § 120 of any United States application(s) listed below and, insofar as the subject matter of each of the claims of this application is not disclosed in the prior United States application in the manner provided by the first paragraph of Title 35, United States Code, § 112. I acknowledge the duty to disclose to the Office all information known to me to be material to patentability as defined in Title 37, Code of Federal Regulations, § 1.56 which became available between the filing date of the prior application and the national or PCT international filing date of this application

<u>60/072,509</u> (Application Serial No.)	<u>January 26, 1998</u> (Filing Date)	_____ (Status) (patented, pending, abandoned)
_____ (Application Serial No.)	_____ (Filing Date)	_____ (Status) (patented, pending, abandoned)
_____ (Application Serial No.)	_____ (Filing Date)	_____ (Status) (patented, pending, abandoned)

I hereby declare that all statements made herein of my own knowledge are true and that all statements made on information and belief are believed to be true; and further that these statements were made with the knowledge that willful false statements and the like so made are punishable by fine or imprisonment, or both, under Section 1001 of Title 18 of the United States Code and that such willful false statements may jeopardize the validity of the application or any patent issued thereon.

POWER OF ATTORNEY: As a named inventor, I hereby appoint the following attorney(s) and/or agent(s) to prosecute this application and transact all business in the Patent and Trademark Office connected therewith:

Rudolf E. Hutz, Reg. No. 22,397; Harold Pezzner, Reg. No. 22,112; Richard M. Beck, Reg. No. 22,580; Paul E. Crawford, Reg. No. 24,397; Thomas M. Meshbesher, Reg. No. 25,083; Patricia Smink Rogowski, Reg. No. 33,791; Robert G. McMorrow, Jr., Reg. No.

30,962; Ashley I. Pezzner, Reg. No. 35,646; William E. McShane, Reg. No. 32,707; Mary W. Bourke, Reg. No. 30,982; Gerard M. O'Rourke, Reg. No. 39,794; Allan N. Kutzenko, Reg. No. 38,945; James M. Olsen, Reg. No. 40,408; Francis DiGiovanni, Reg. No. 37,310; J. Kenneth Joung, Reg. No. 41,881; Frank Z. Yang, Reg. No. 35,417; and Eric J. Evain, Reg. No. 42,517, all of P.O. Box 2207, Wilmington, Delaware 19899-2007, my attorneys with full power of substitution and revocation.

Send Correspondence To: Connolly and Hutz P.O. Box 2207 Wilmington, Delaware 19899-2207		Direct Telephone Calls To: (302) 658-9141
FULL NAME OF SOLE OR FIRST INVENTOR Wayne Westerman	INVENTOR'S SIGNATURE <i>Wayne Westerman</i>	DATE January 25, 1999
RESIDENCE Wellington, Missouri		CITIZENSHIP United States
POST OFFICE ADDRESS P.O. Box 354, 715 Oak Street, Wellington, Missouri 64097		
FULL NAME OF SECOND JOINT INVENTOR John G. Elias	INVENTOR'S SIGNATURE <i>John G. Elias</i>	DATE JAN 25, 1999
RESIDENCE Townsend, Delaware		CITIZENSHIP United States
POST OFFICE ADDRESS Huguenot Farm, 798 Taylors Bridge Road, Townsend, Delaware 19734		
FULL NAME OF THIRD JOINT INVENTOR	INVENTOR'S SIGNATURE	DATE
RESIDENCE		CITIZENSHIP
POST OFFICE ADDRESS		
FULL NAME OF FOURTH JOINT INVENTOR	INVENTOR'S SIGNATURE	DATE
RESIDENCE		CITIZENSHIP
POST OFFICE ADDRESS		

F:\DOCS\WLM\PAT\NJMO\59830.WPD

Under the Paperwork Reduction Act of 1995, no persons are required to respond to a collection of information unless it displays a valid OMB control number.

POWER OF ATTORNEY TO PROSECUTE APPLICATIONS BEFORE THE USPTO

I hereby revoke all previous powers of attorney given in the application identified in the attached statement under 37 CFR 3.73(b).

I hereby appoint:

 Practitioners associated with the Customer Number:

29855

OR

 Practitioner(s) named below (if more than ten patent practitioners are to be named, then a customer number must be used):

Name	Registration Number	Name	Registration Number

as attorney(s) or agent(s) to represent the undersigned before the United States Patent and Trademark Office (USPTO) in connection with any and all patent applications assigned only to the undersigned according to the USPTO assignment records or assignment documents attached to this form in accordance with 37 CFR 3.73(b).

Please change the correspondence address for the application identified in the attached statement under 37 CFR 3.73(b) to:

 The address associated with Customer Number:

29855

OR

<input type="checkbox"/> Firm or Individual Name			
Address			
City	State	Zip	
Country			
Telephone	Email		

Assignee Name and Address:

FINGERWORKS, INC.
20333 State Highway 249, Suite 600
Houston, Texas 77070

A copy of this form, together with a statement under 37 CFR 3.73(b) (Form PTO/SB/96 or equivalent) is required to be filed in each application in which this form is used. The statement under 37 CFR 3.73(b) may be completed by one of the practitioners appointed in this form if the appointed practitioner is authorized to act on behalf of the assignee, and must identify the application in which this Power of Attorney is to be filed.

SIGNATURE of Assignee of Record

The individual whose signature and title is supplied below is authorized to act on behalf of the assignee

Signature	<i>Michelle A. LaVally</i>	Date	<i>Sept. 7, 2005</i>
Name	Michelle A. LaVally	Telephone	
Title	Assistant Secretary		

This collection of information is required by 37 CFR 1.31, 1.32 and 1.33. The information is required to obtain or retain a benefit by the public which is to file (and by the USPTO to process) an application. Confidentiality is governed by 35 U.S.C. 122 and 37 CFR 1.11 and 1.14. This collection is estimated to take 3 minutes to complete, including gathering, preparing, and submitting the completed application form to the USPTO. Time will vary depending upon the individual case. Any comments on the amount of time you require to complete this form and/or suggestions for reducing this burden, should be sent to the Chief Information Officer, U.S. Patent and Trademark Office, U.S. Department of Commerce, P.O. Box 1450, Alexandria, VA 22313-1450. DO NOT SEND FEES OR COMPLETED FORMS TO THIS ADDRESS. **SEND TO: Commissioner for Patents, P.O. Box 1450, Alexandria, VA 22313-1450.**

If you need assistance in completing the form, call 1-800-PTO-9199 and select option 2.

IN THE UNITED STATES PATENT AND TRADEMARK OFFICE

In re Application of:	§	Customer No.: 29855
Wayne C. Westerman	§	
John G. Elias	§	Confirmation No.: _____
	§	
Assignee: Fingerworks, Inc.	§	Art Unit: _____
	§	
Serial No.: _____	§	Examiner: _____
	§	Phone: _____
Filed: HEREWITH	§	
	§	
For: ELLIPSE FITTING FOR MULTI-TOUCH SURFACES	§	Atty. Dkt. No.: 119-0092USCD
	§	

STATEMENT UNDER 37 C.F.R. § 3.73(B)
AND
EXCLUSION OF INVENTIVE ENTITY AND/OR PREVIOUS ASSIGNEE
UNDER 37 C.F.R. § 3.71(A)

Commissioner for Patents
P.O. Box 1450
Alexandria VA, 22313-1450

Sir:

The above-referenced Assignee (“Assignee”) of record of the entire interest in the above-referenced application (“Application”) by virtue of an assignment or assignments as set forth below, hereby elects, under 37 C.F.R. § 3.71(a), to prosecute the Application to the exclusion of the inventive entity (i.e., the inventors) and any previous assignees of the Application.

Pursuant to 37 C.F.R. § 3.73(b), the undersigned has reviewed the assignment or assignments referenced below, and certifies that to the best of my knowledge and belief, title remains in the name of the Assignee. The undersigned is authorized on behalf of the Assignee to execute this paper by virtue of a General Power of Attorney filed herewith.

Please direct any communications pertaining to this Application to:

Billy C. Allen III, Reg. No. 46,147
WONG, CABELLO, LUTSCH, RUTHERFORD & BRUCCULERI, LLP
20333 State Highway 249, Suite 600
Houston, TX 77070
Phone: 832-446-2400
Fax: 832-446-2424
e-mail: wcpatent@counselip.com

/Billy C. Allen III/

Billy C. Allen III, Reg. No. 46,147
(of Customer Number 29855)

Attorney of Record

Date: February 21, 2007

ASSIGNMENT:

Concurrently filed for recordation

Previously recorded at:

Date: September 16, 2005

Reel: 016536

Frame: 0701

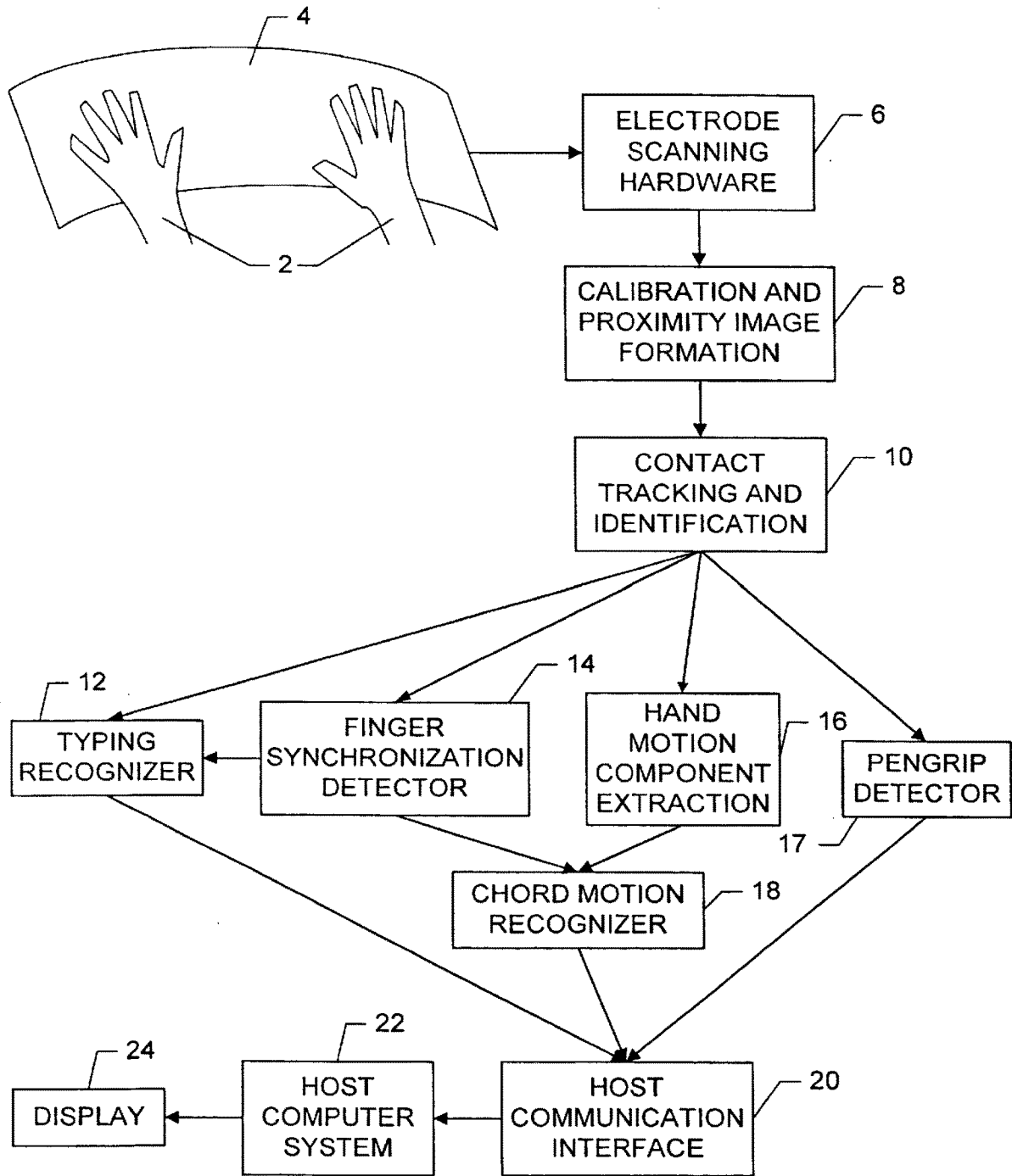

FIG. 1

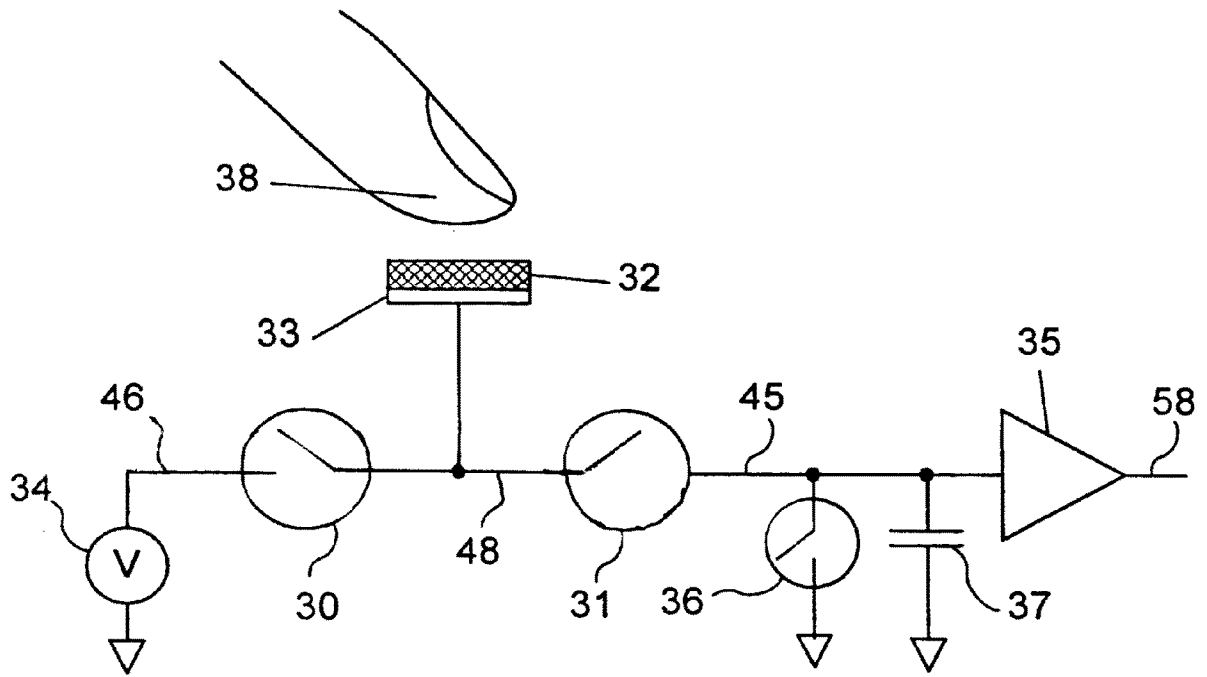

FIG. 2

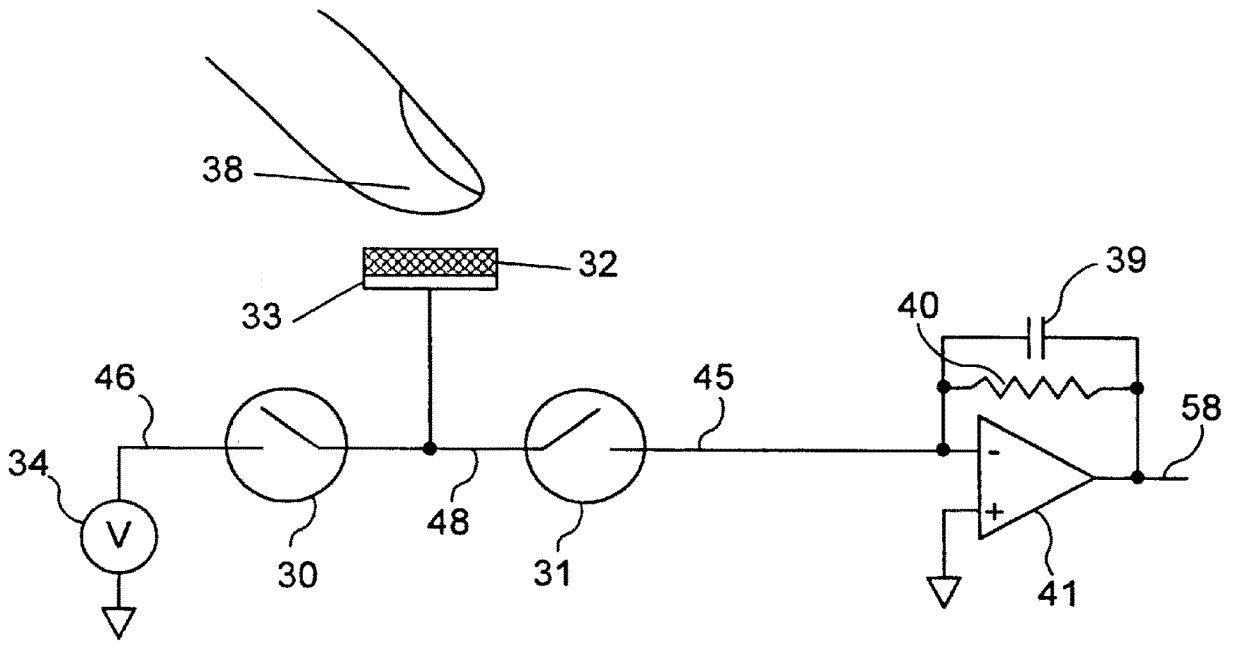

FIG. 3A

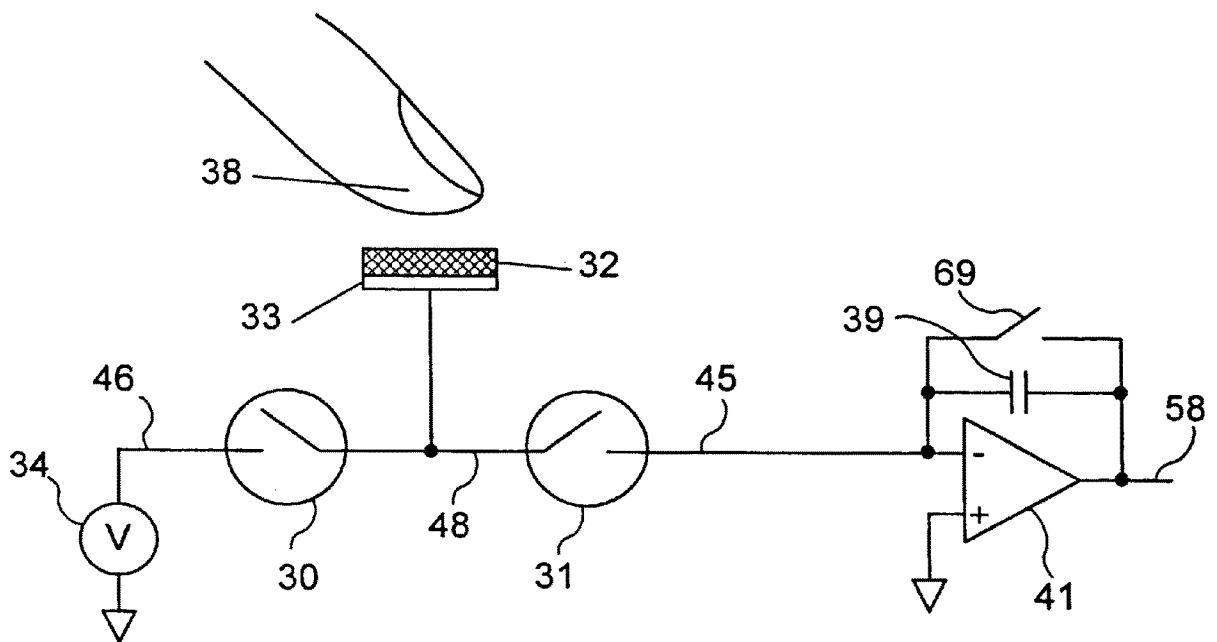

FIG. 3B

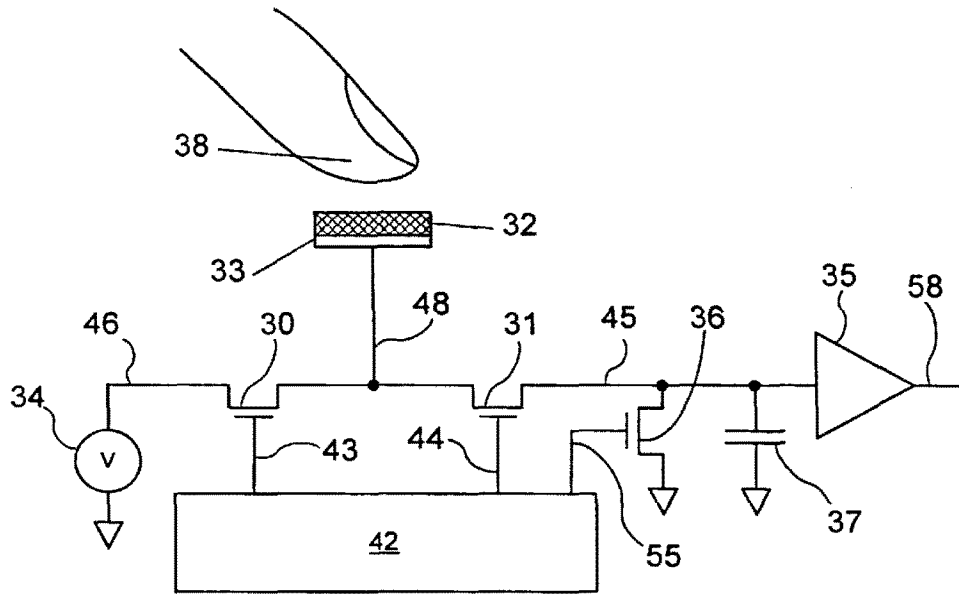

FIG. 4A

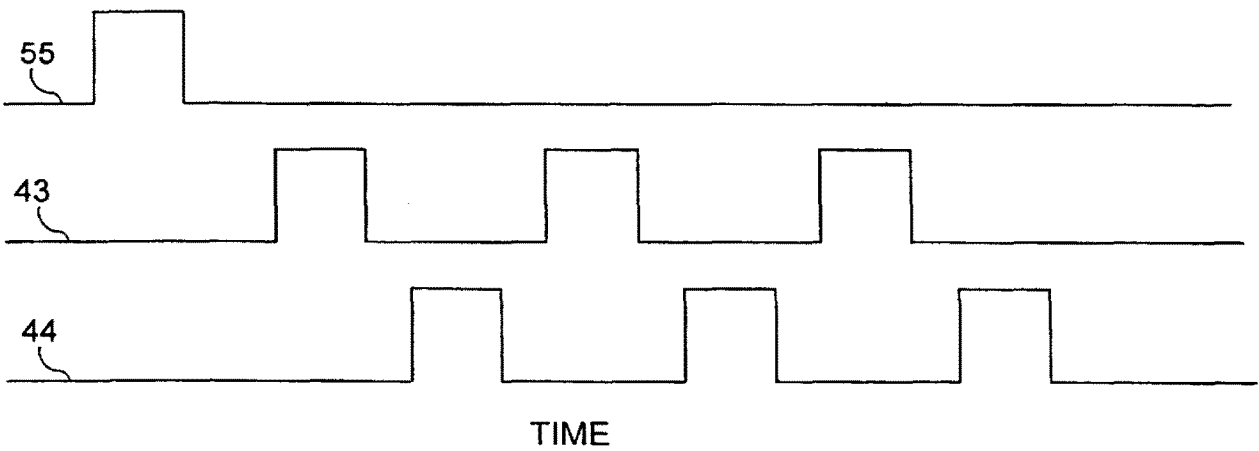

FIG. 4B

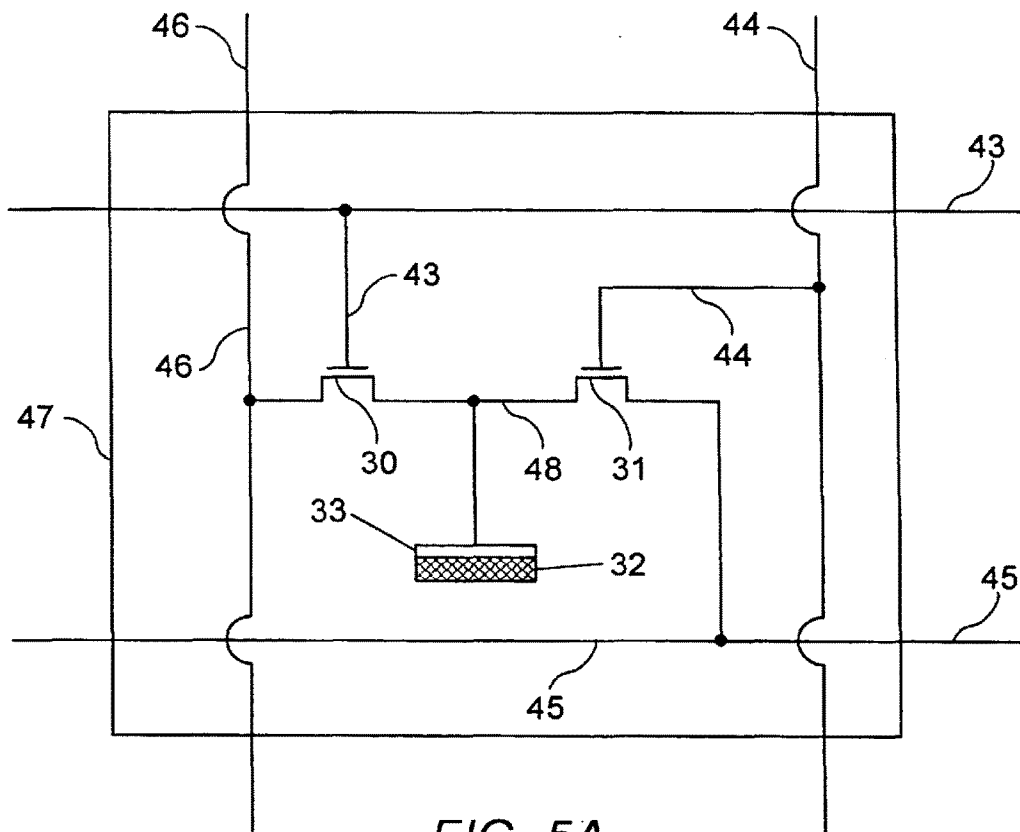

FIG. 5A

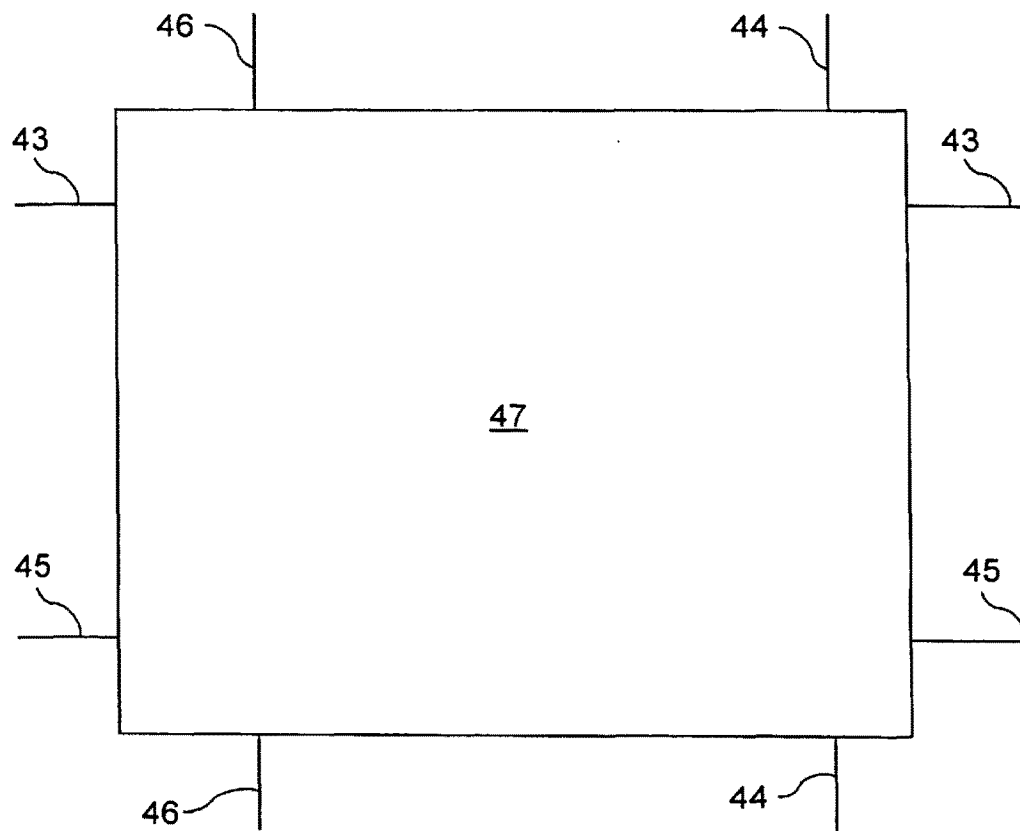

FIG. 5B

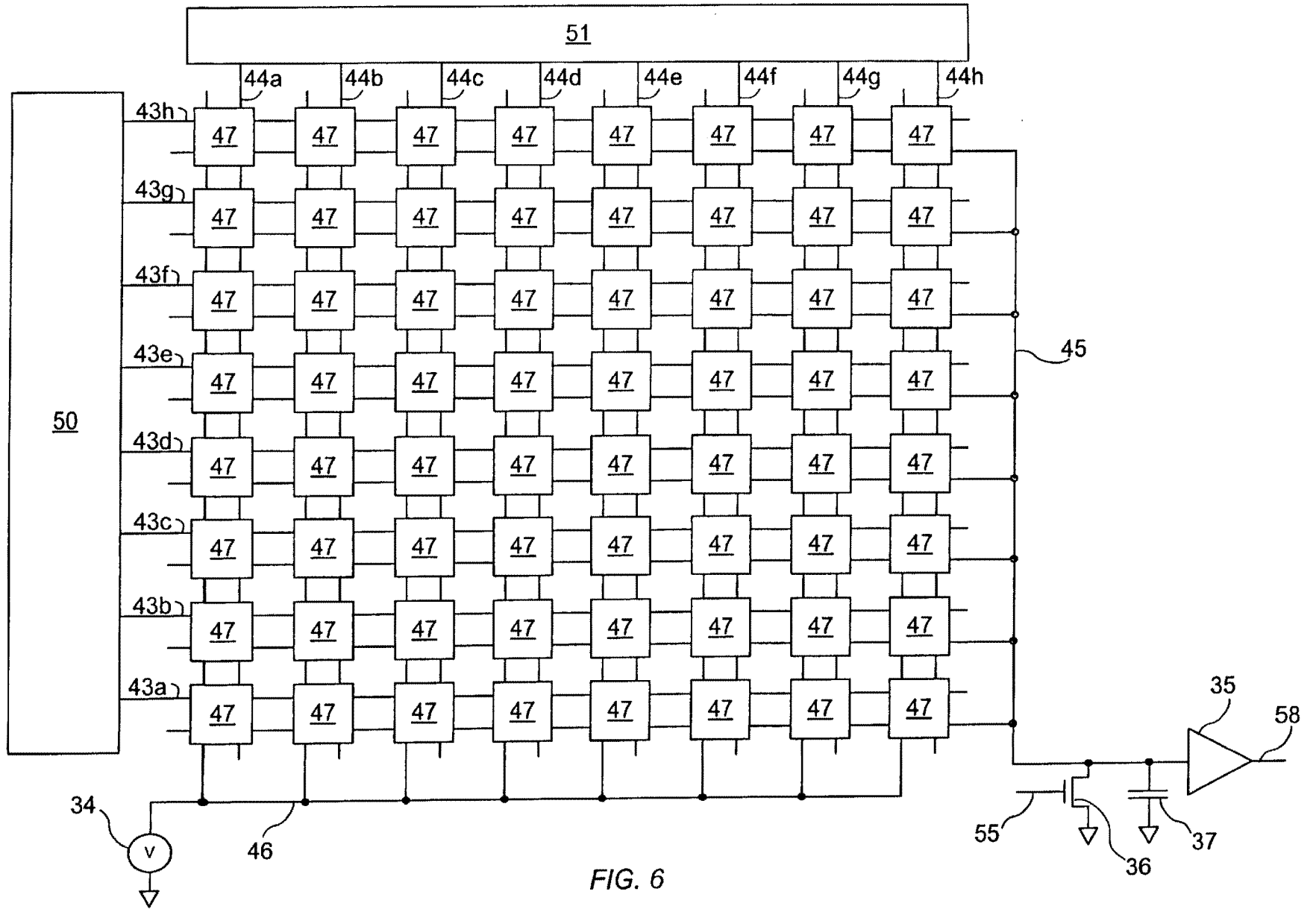

FIG. 6

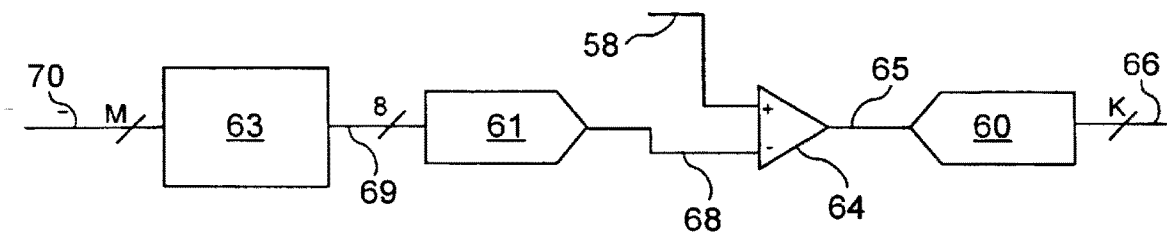

FIG. 7A

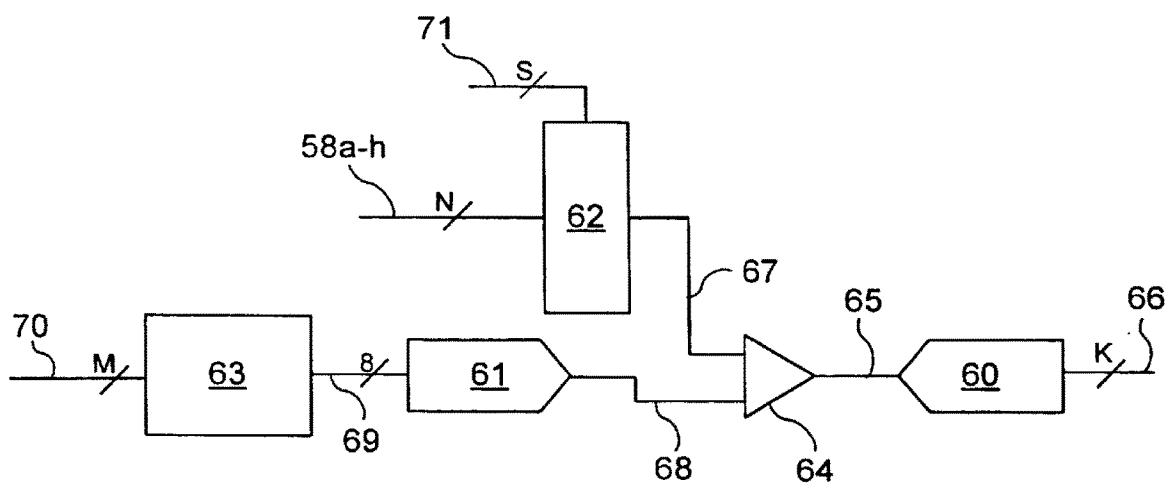
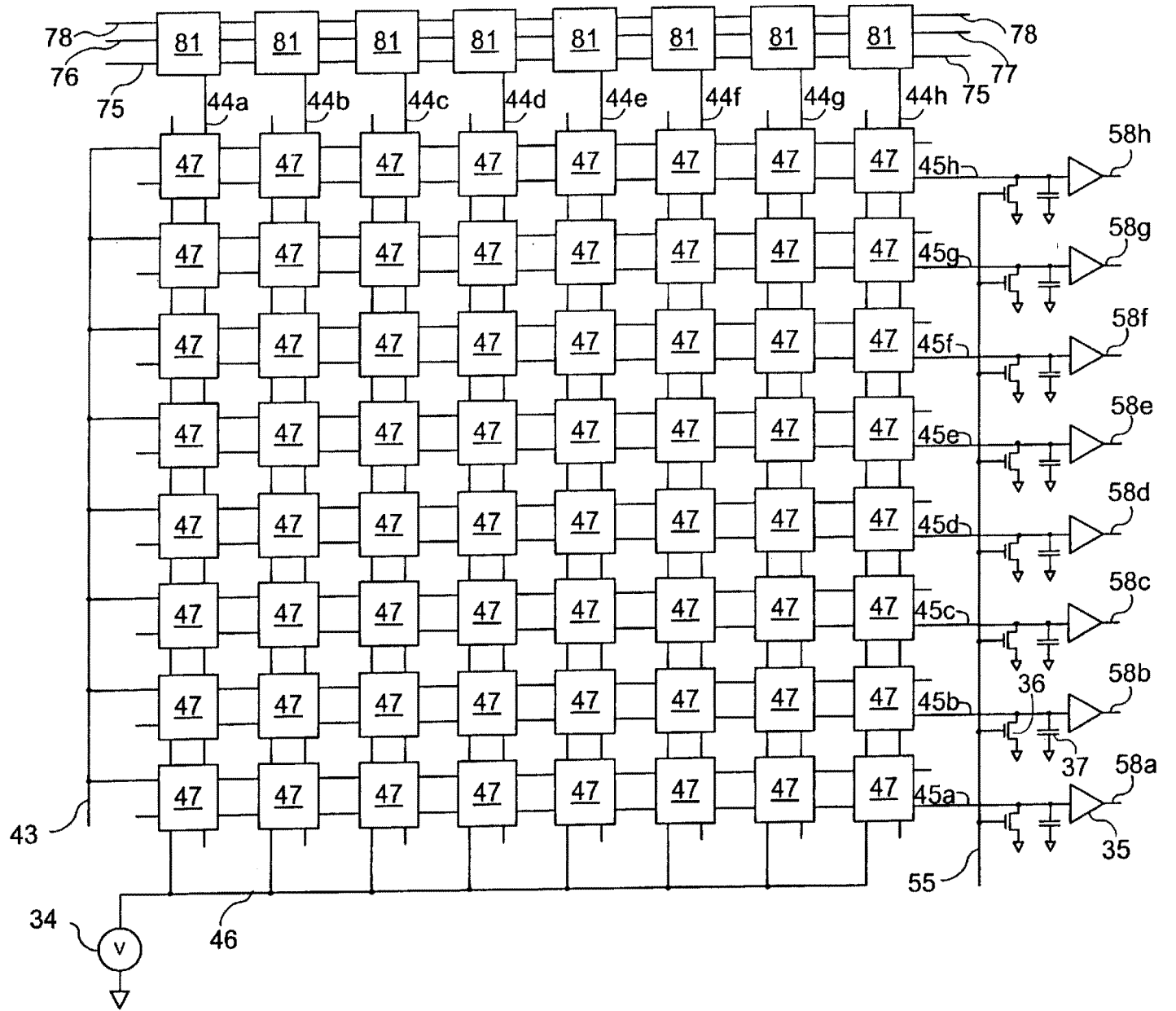
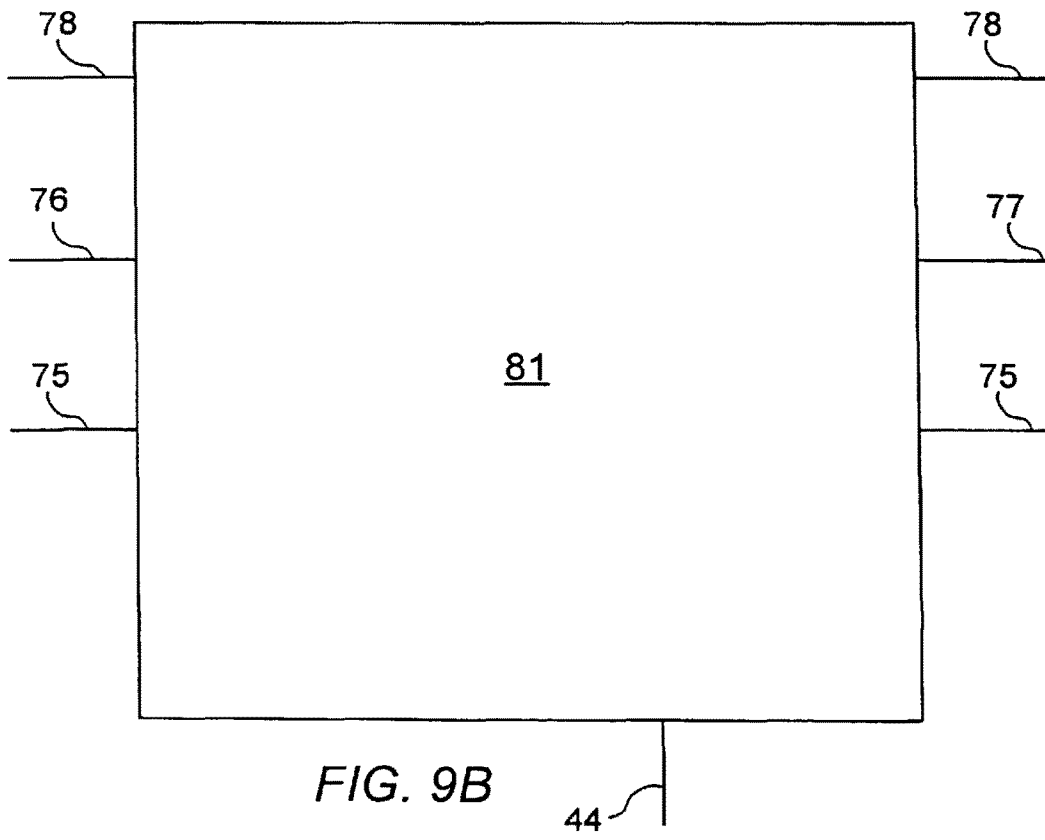
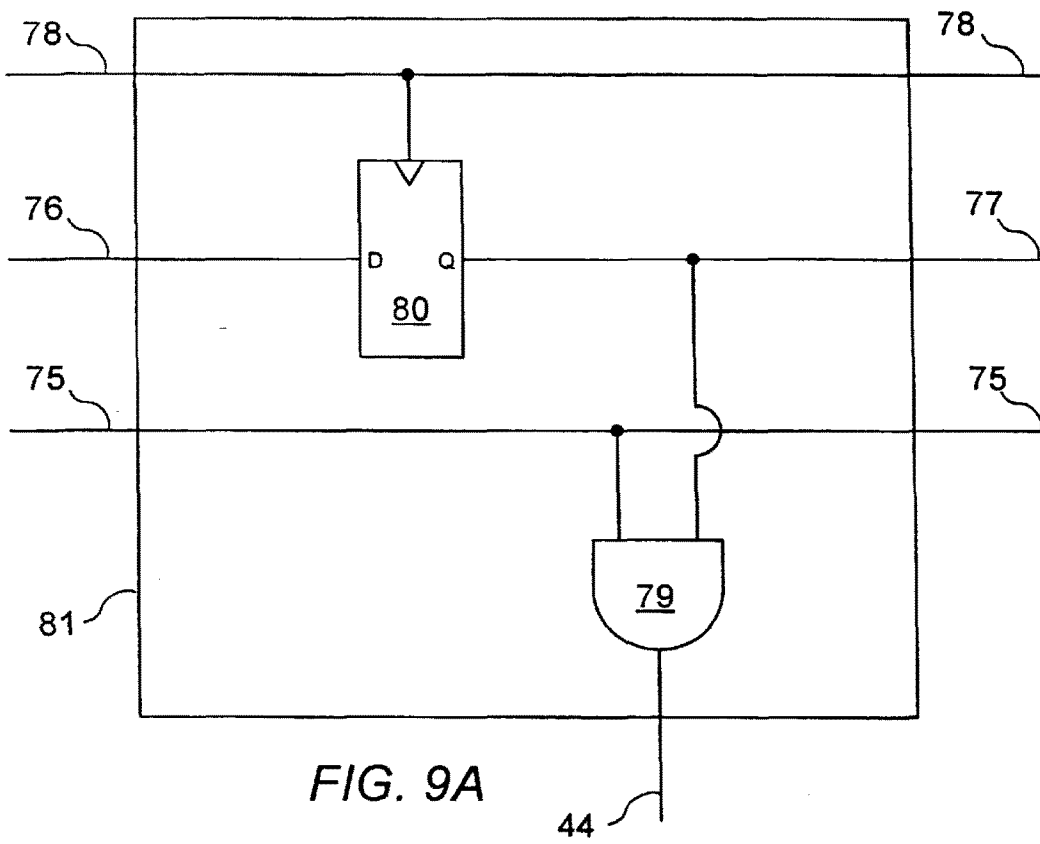

FIG. 7B

FIG. 8





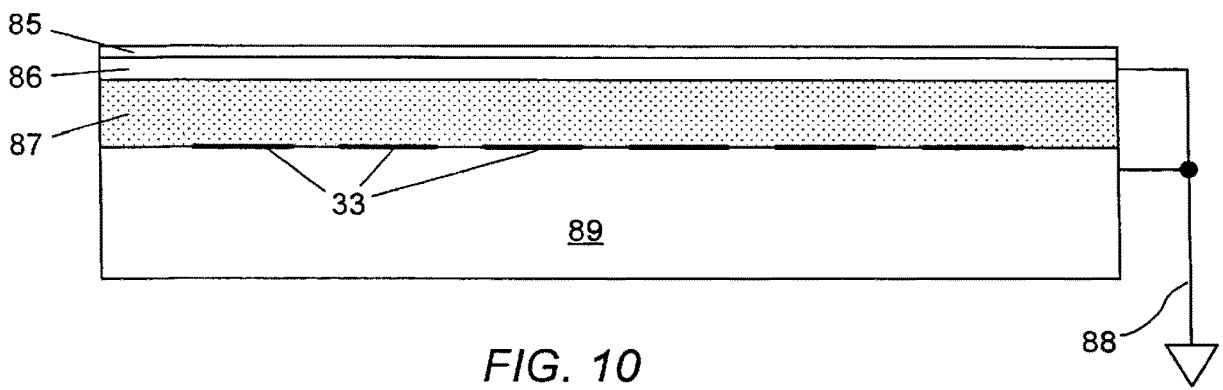

FIG. 10

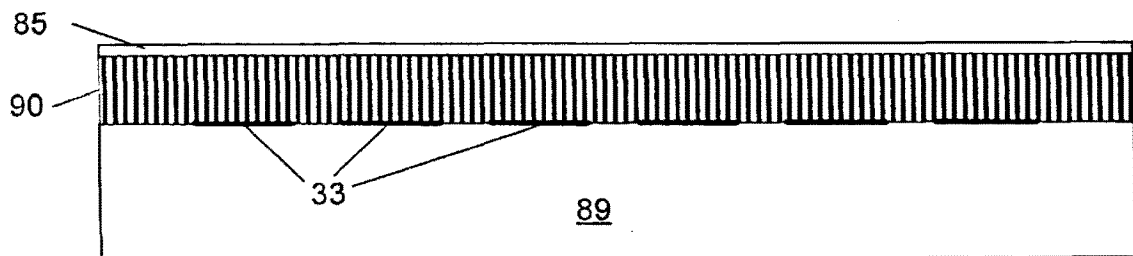

FIG. 11

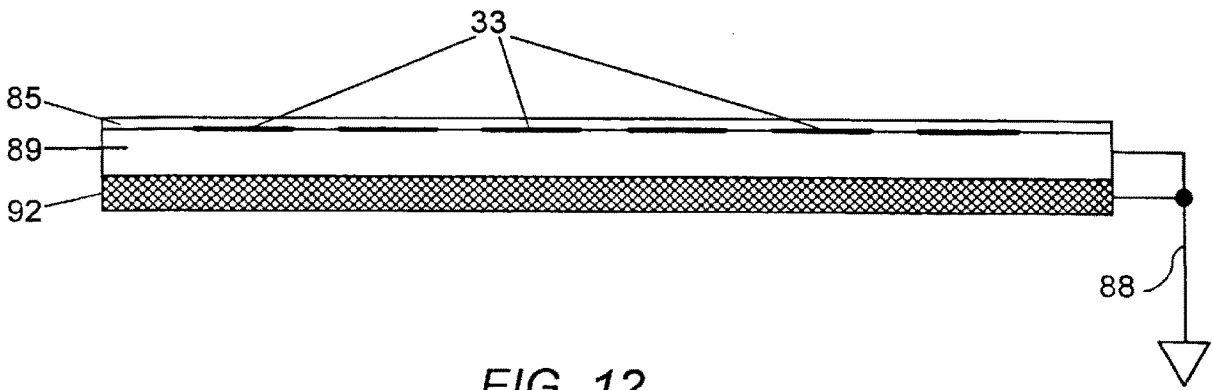

FIG. 12

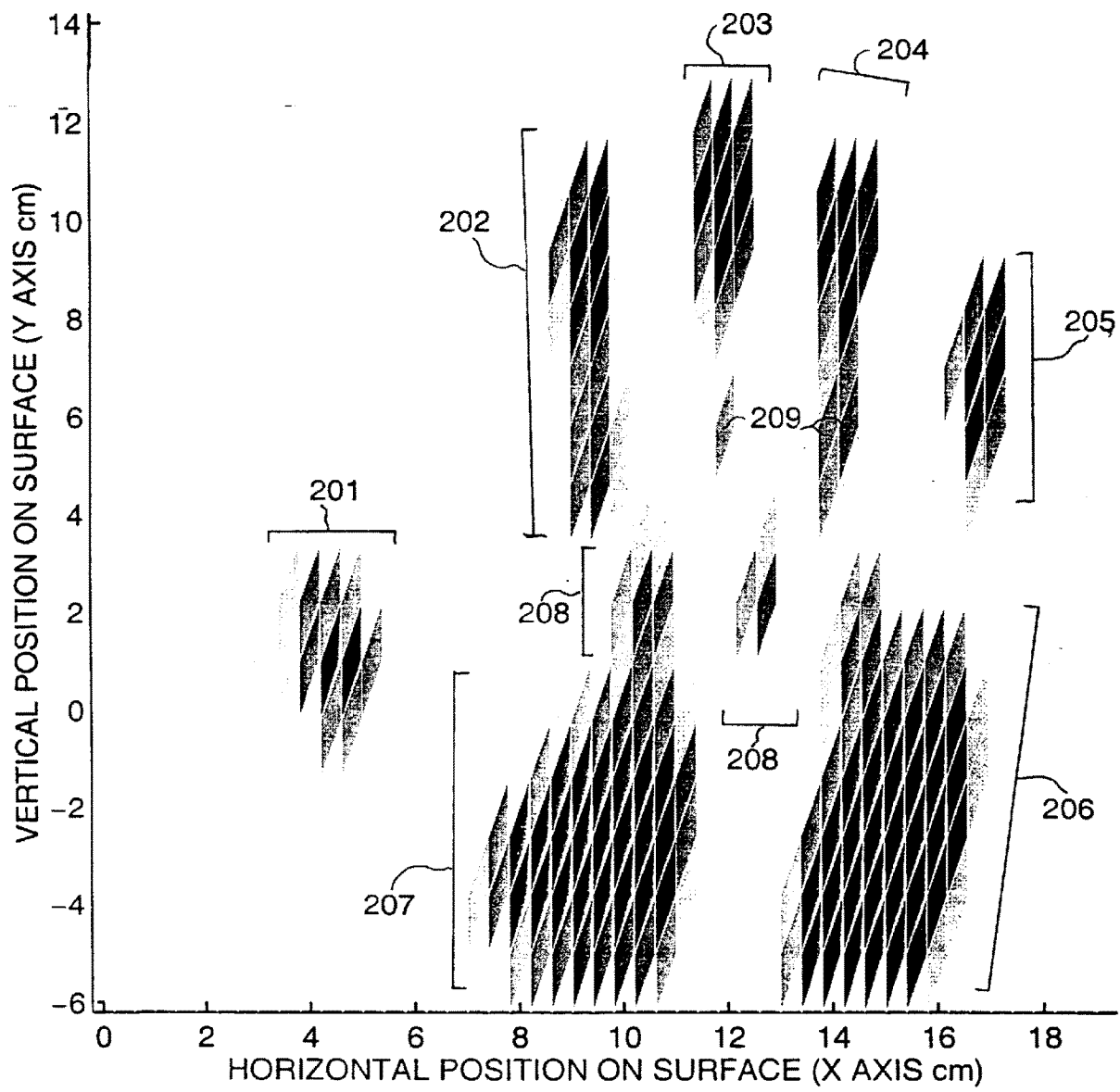

FIG. 13

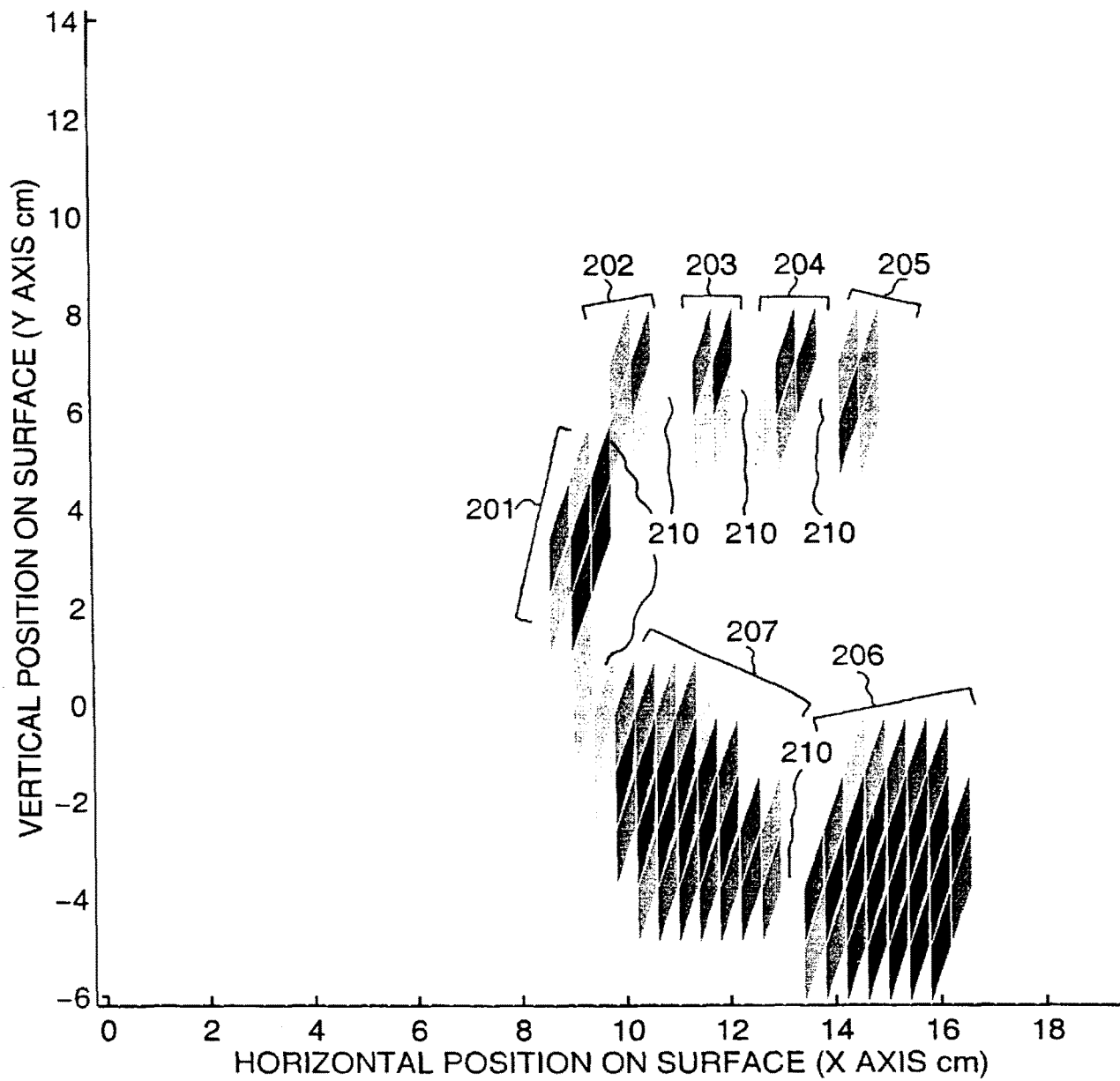

FIG. 14

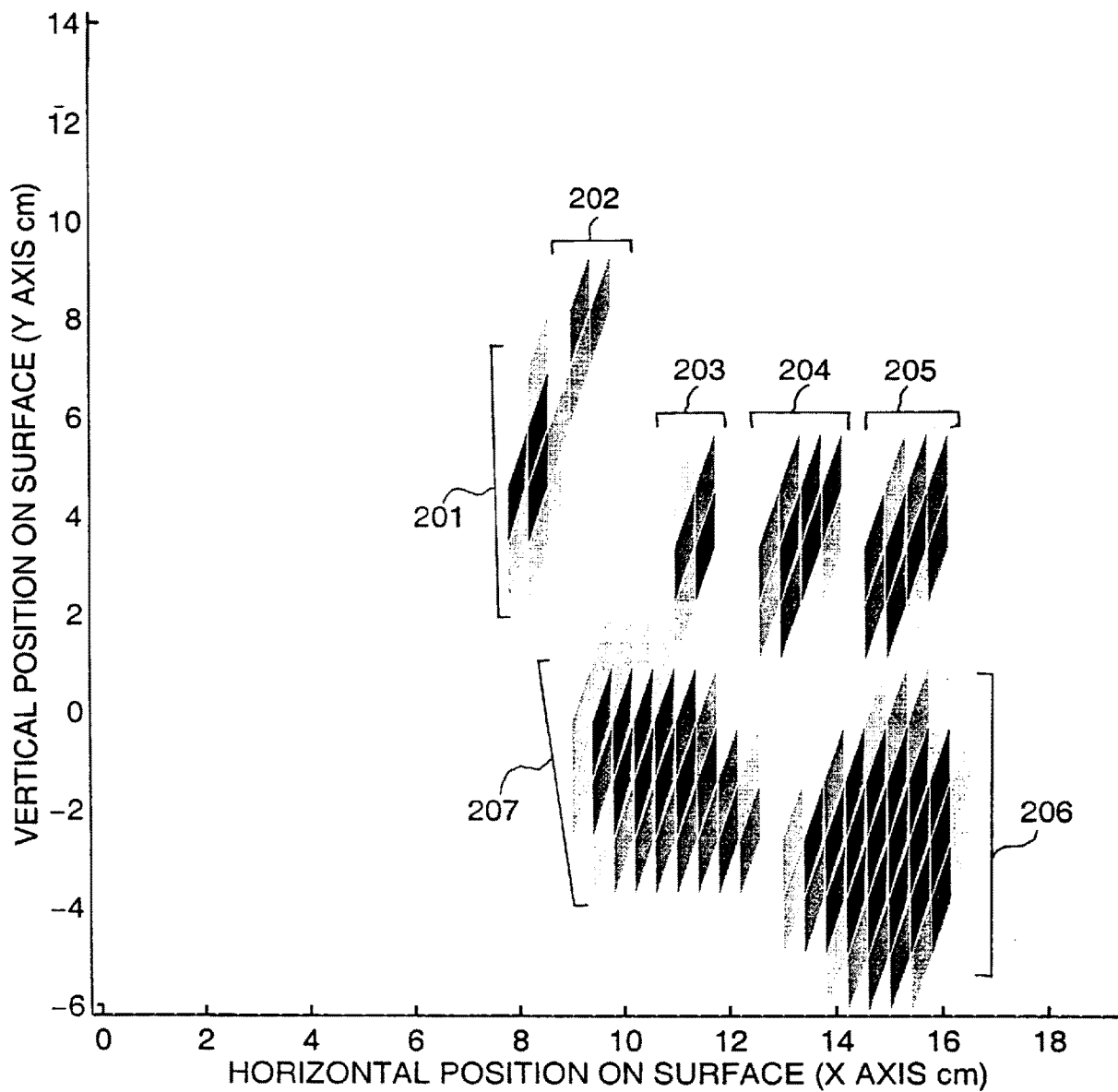

FIG. 15

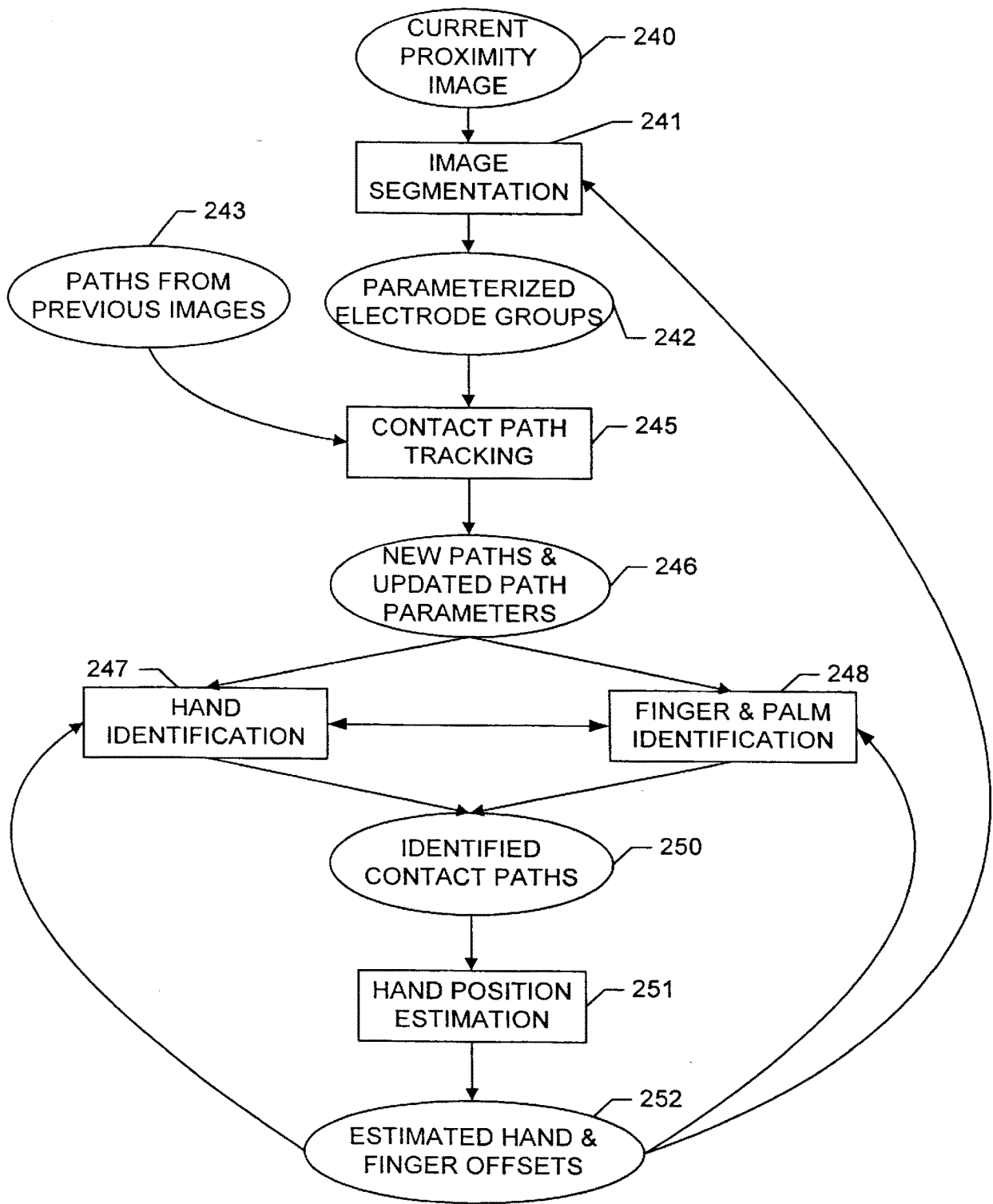

FIG. 16

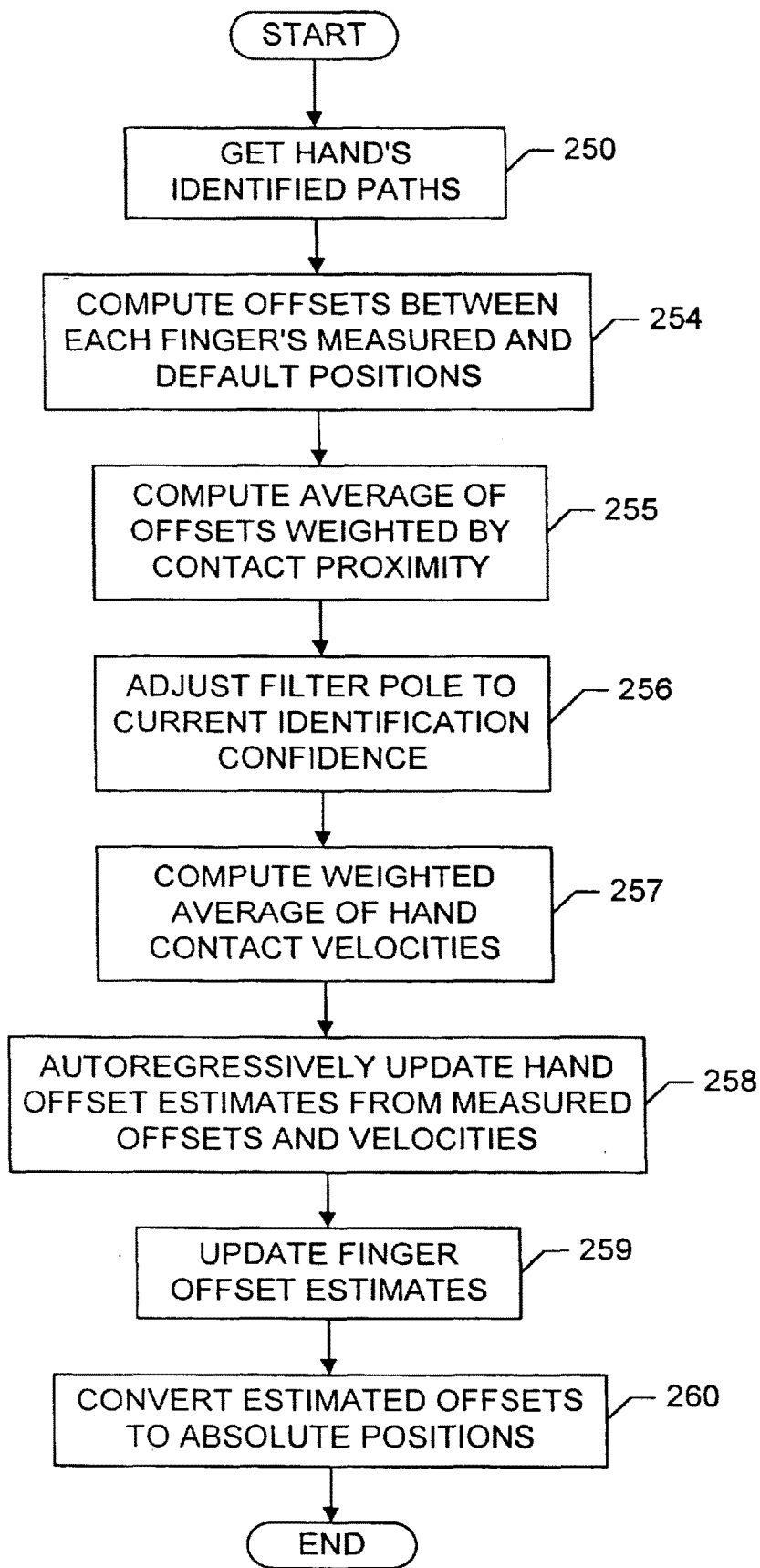

FIG. 17

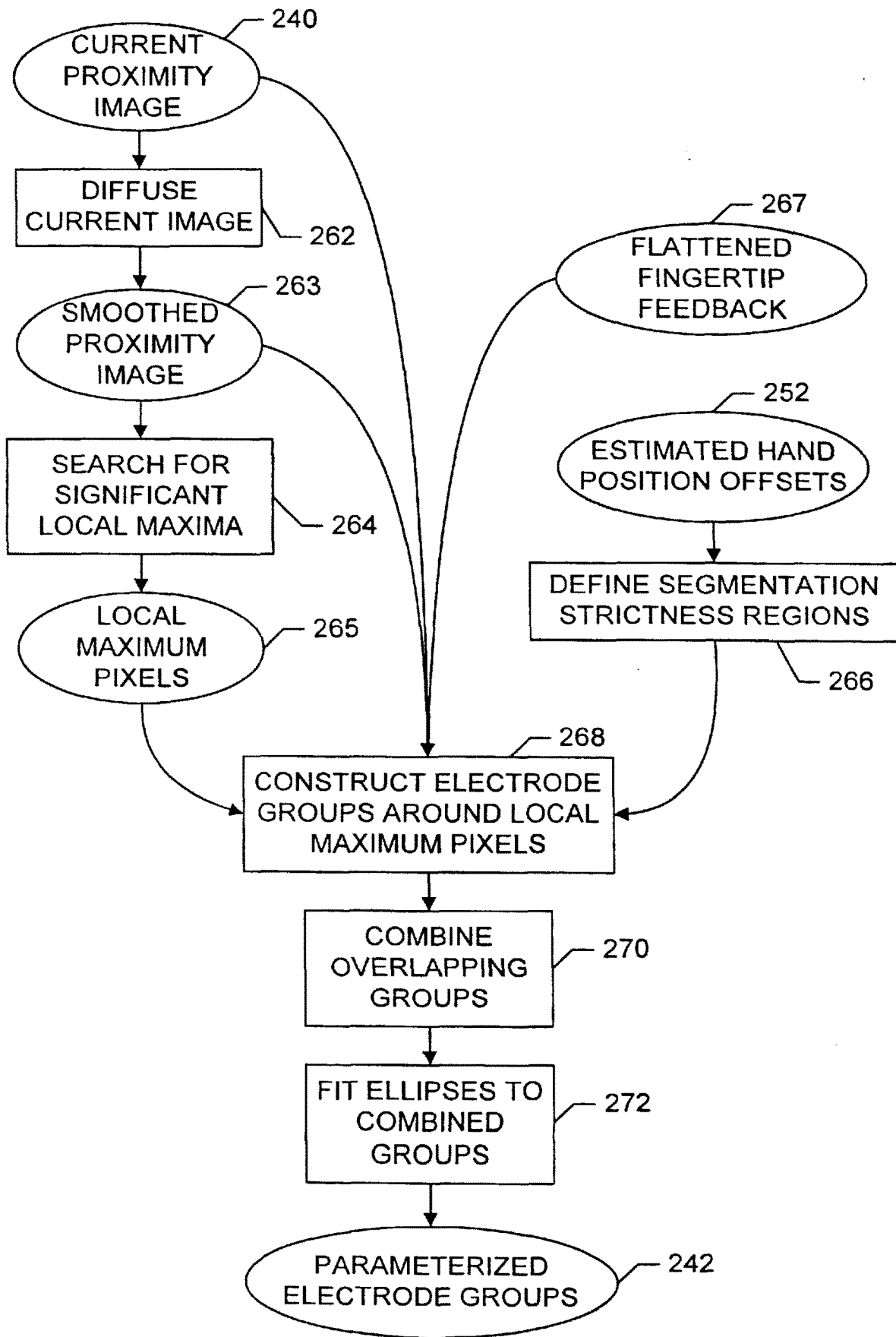

FIG. 18

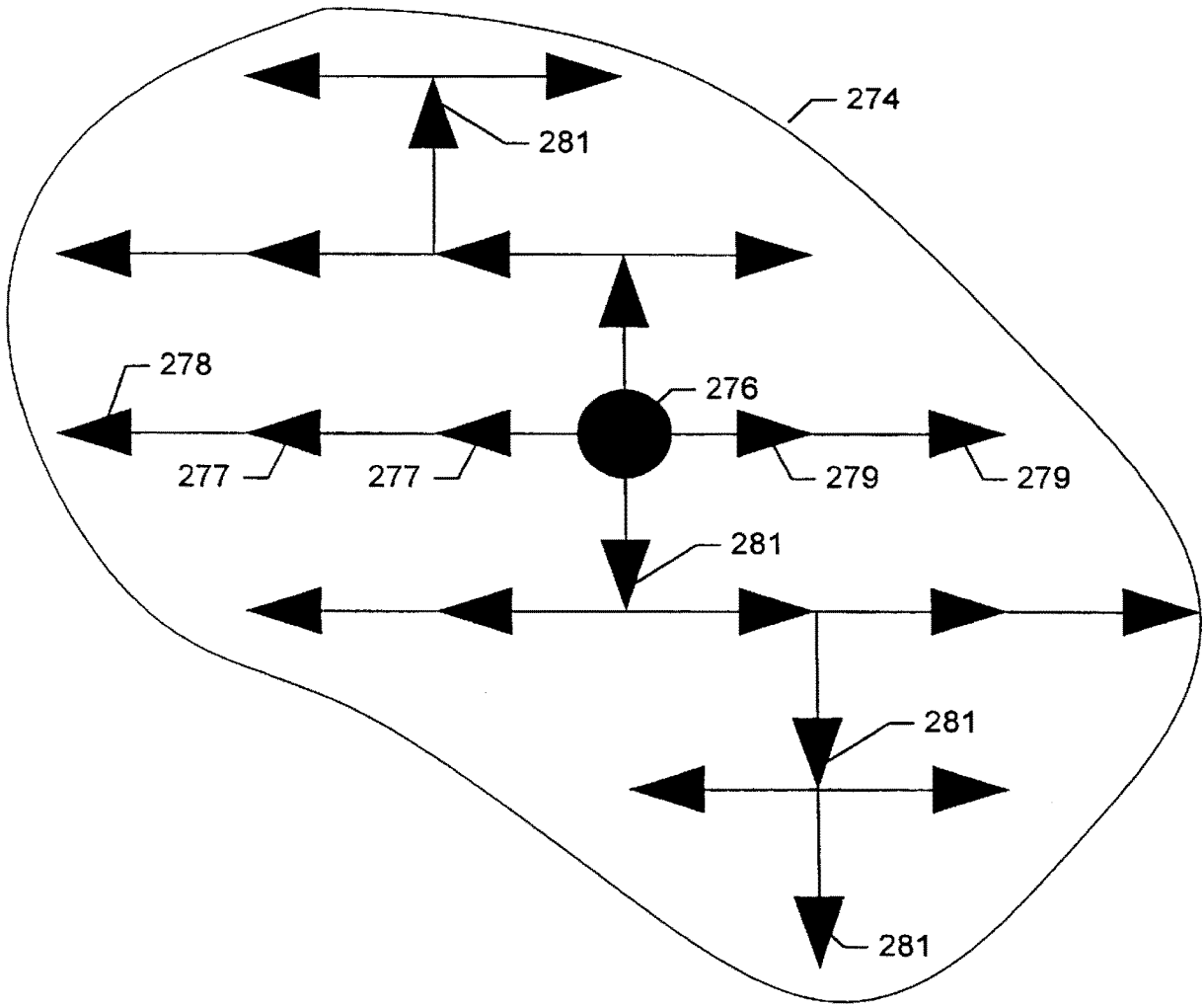

FIG. 19

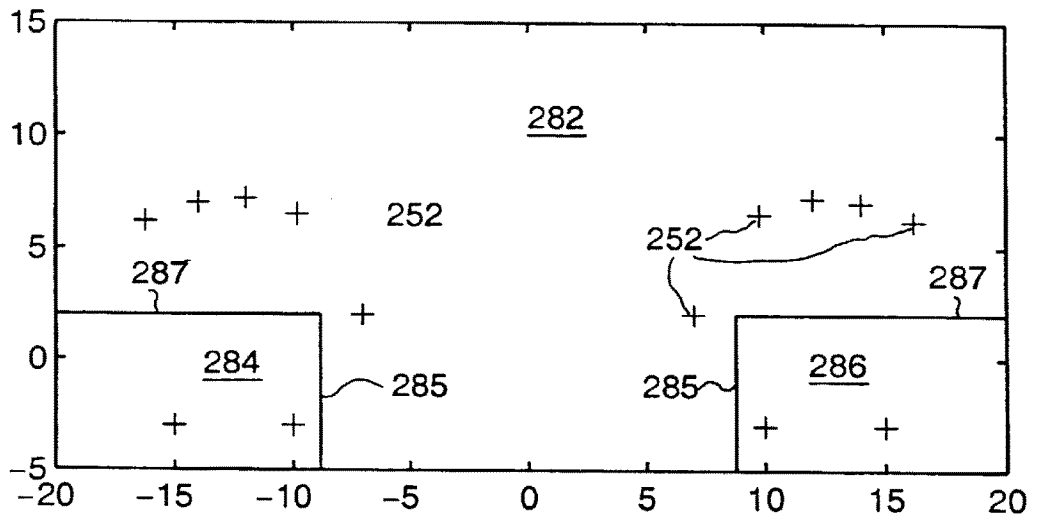

FIG. 20A

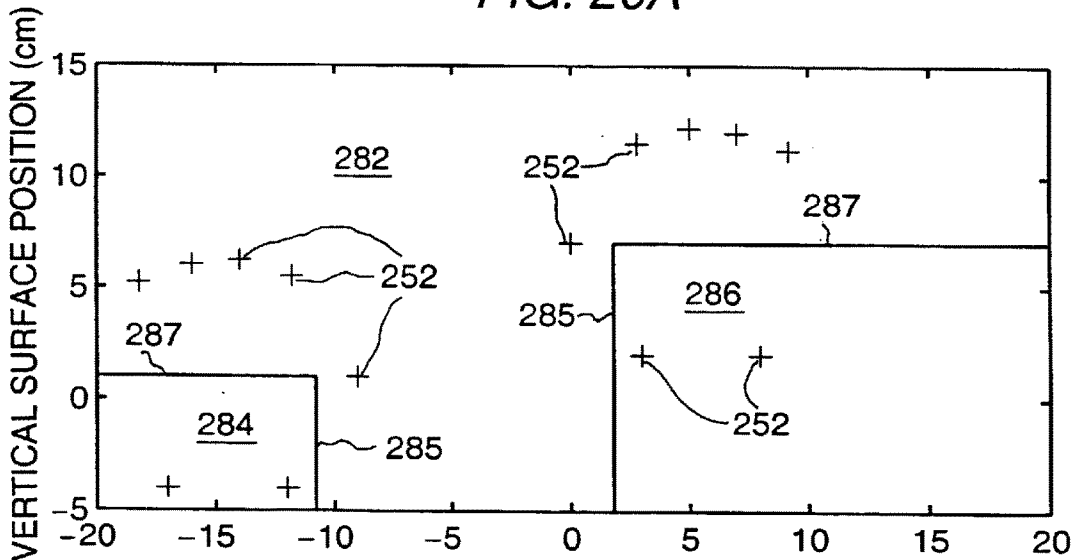

FIG. 20B

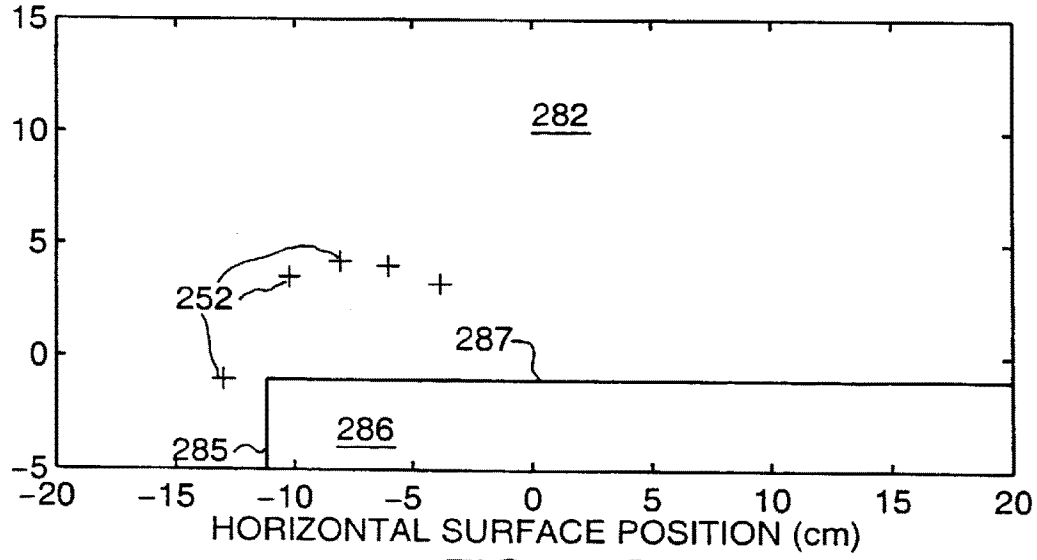

FIG. 20C

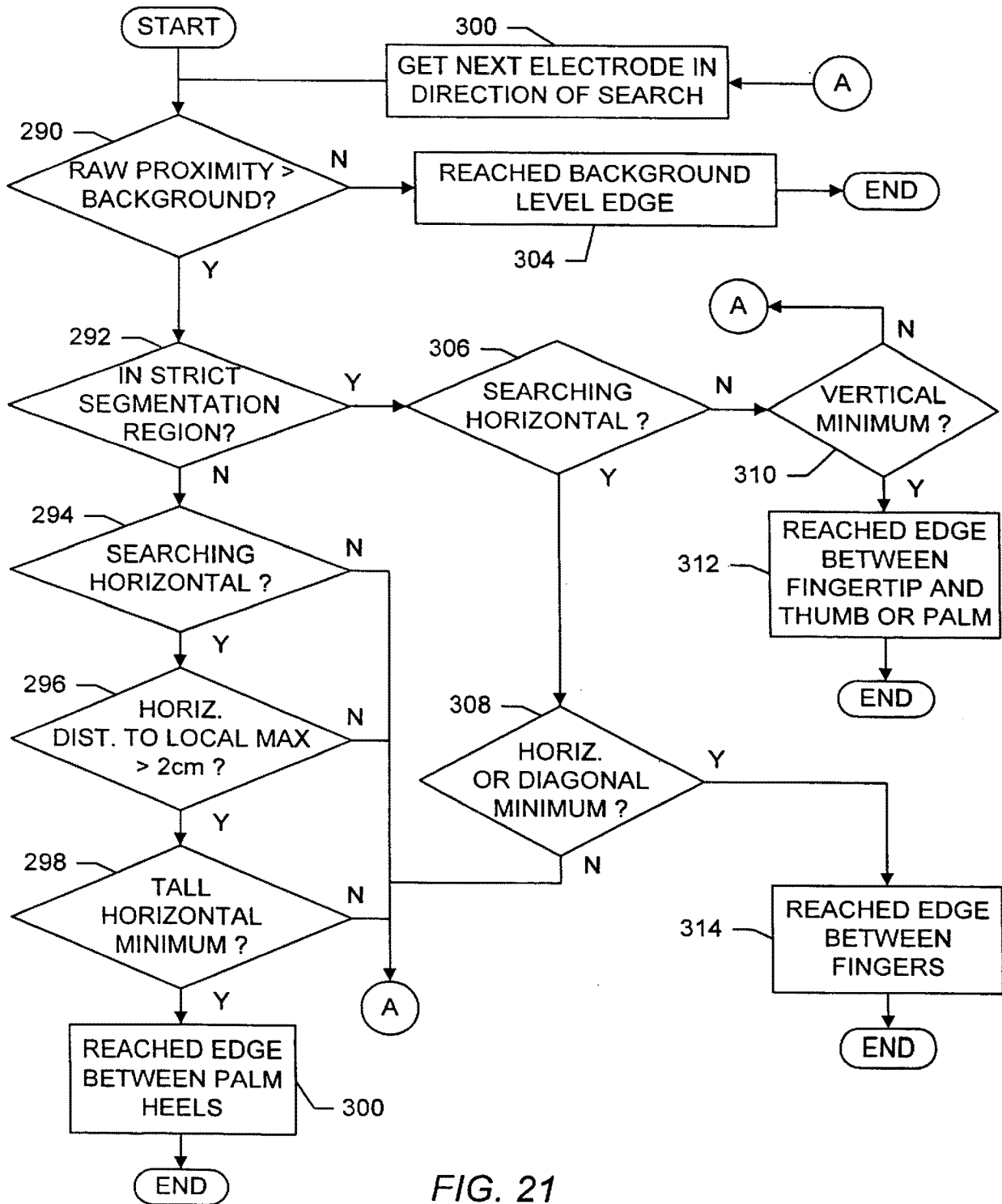

FIG. 21

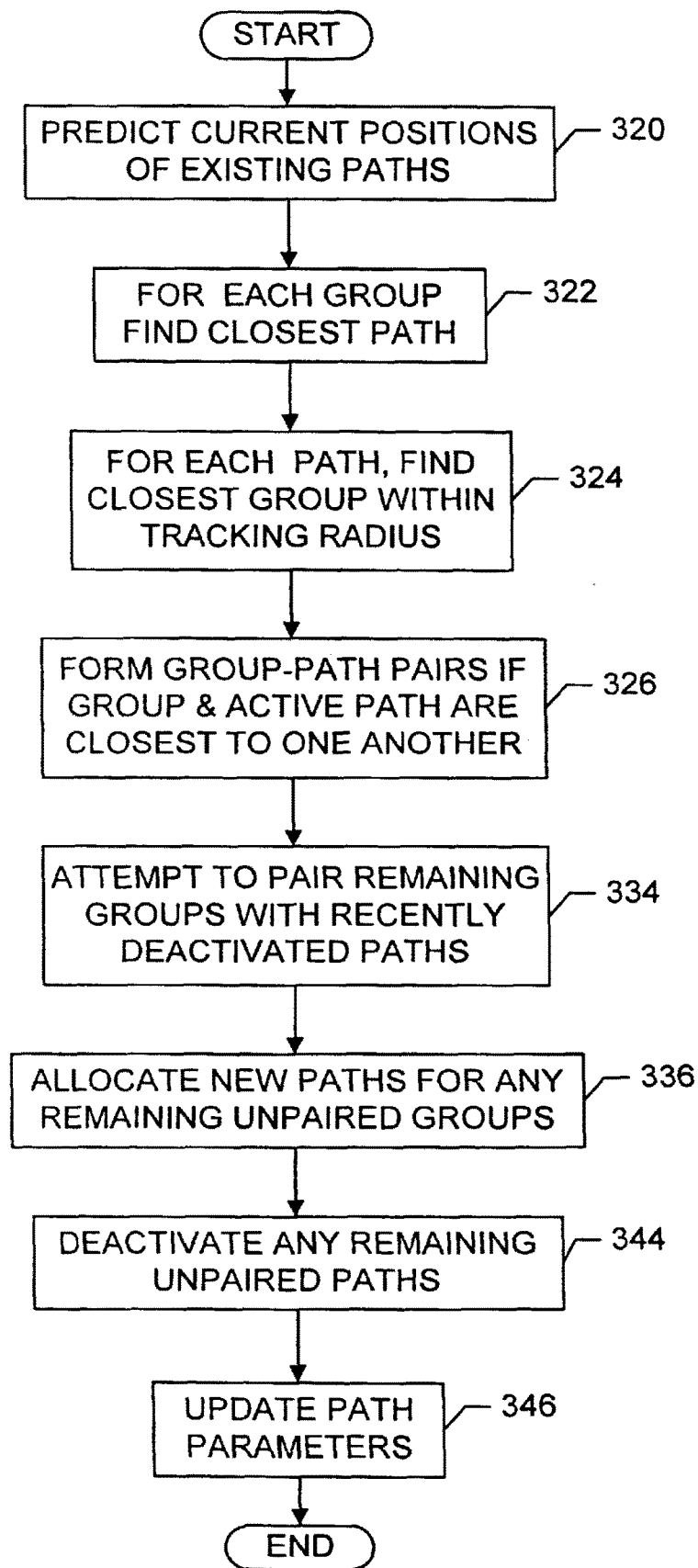

FIG. 22

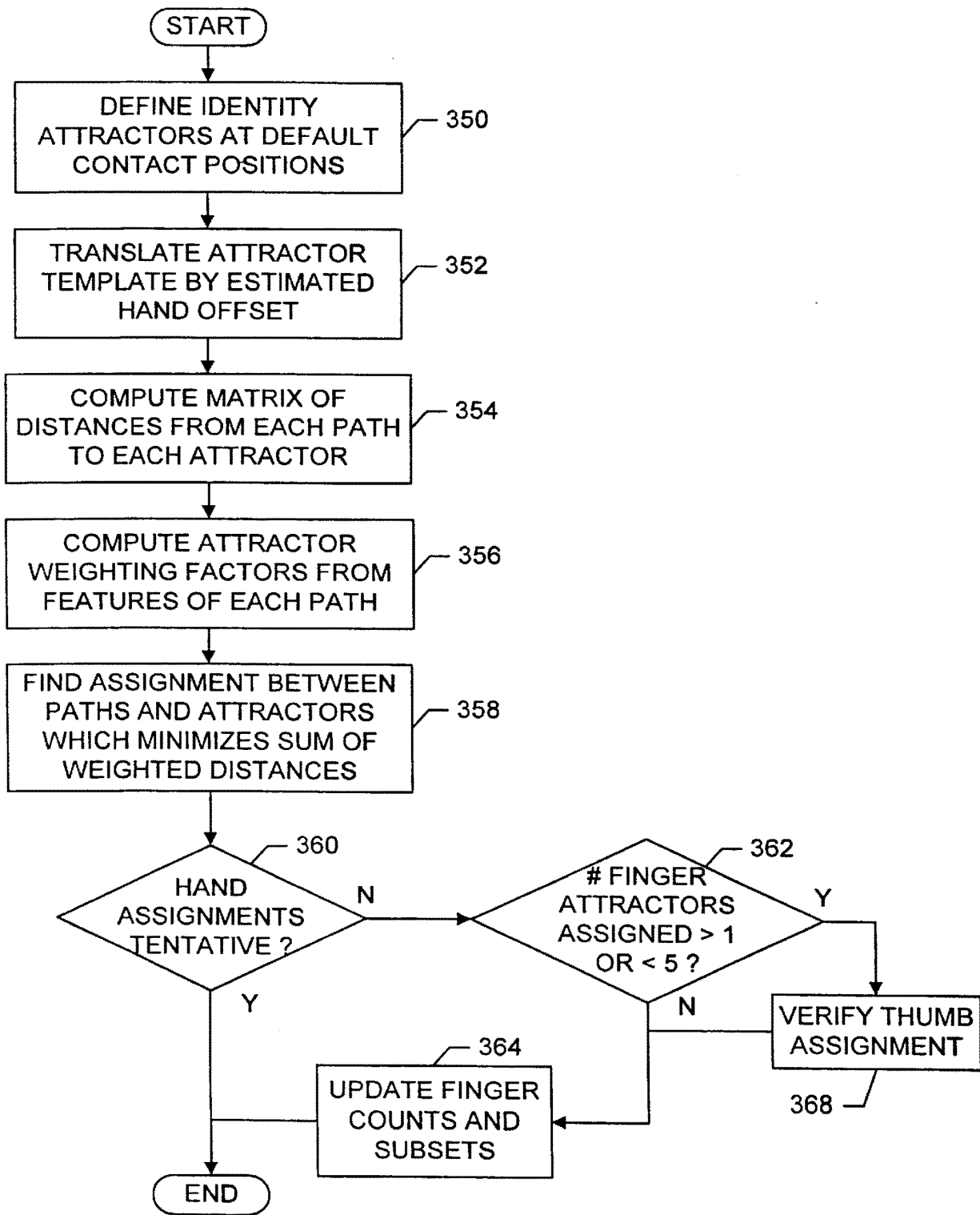

FIG. 23

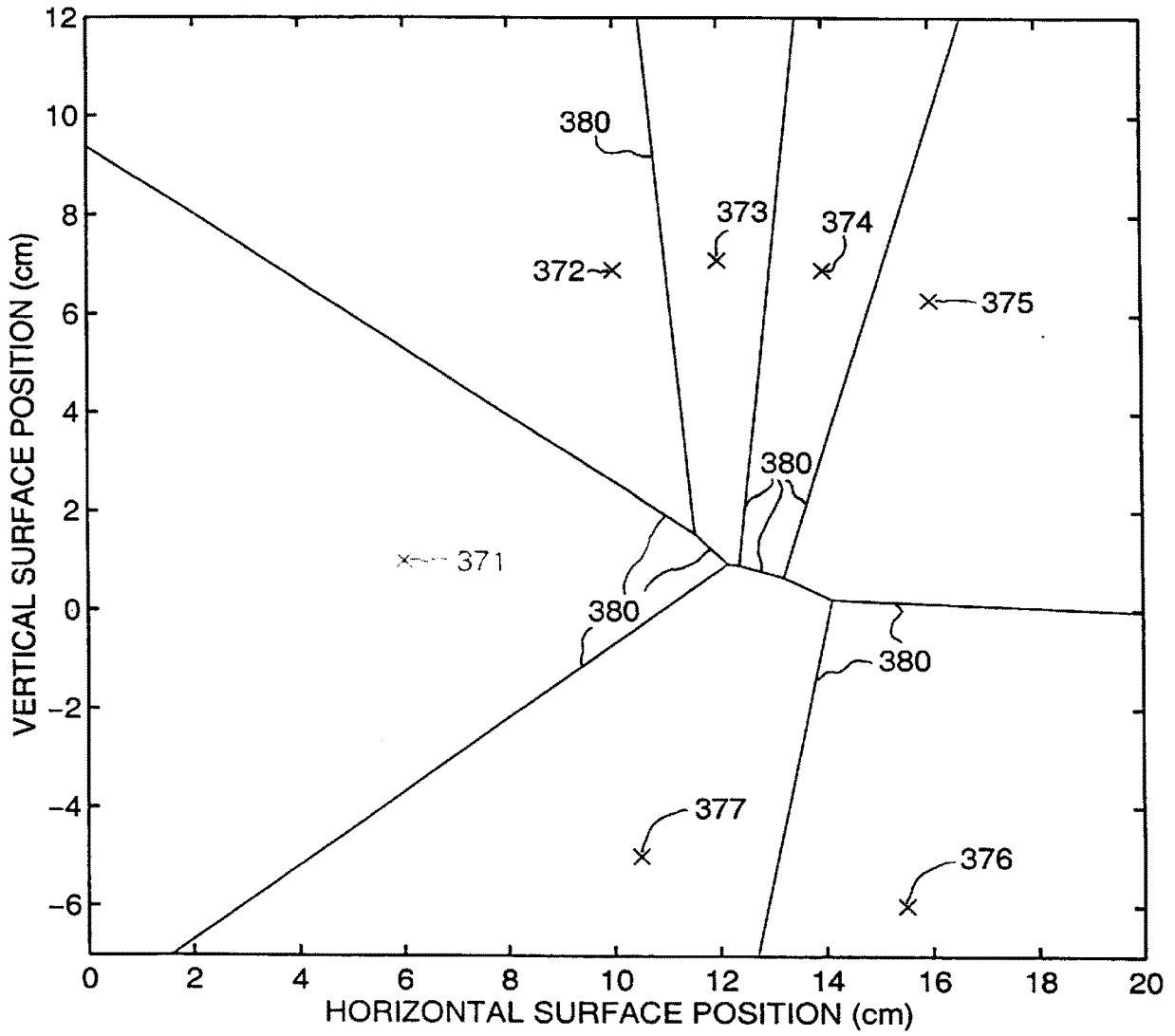

FIG. 24

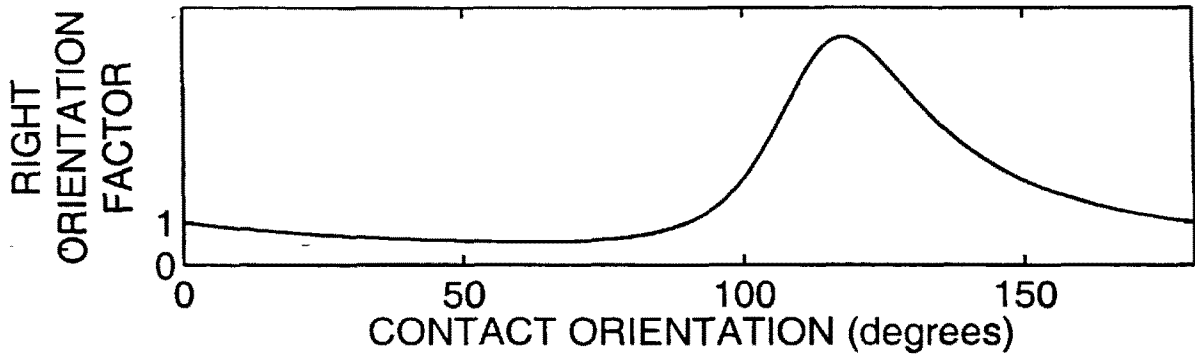

FIG. 25A

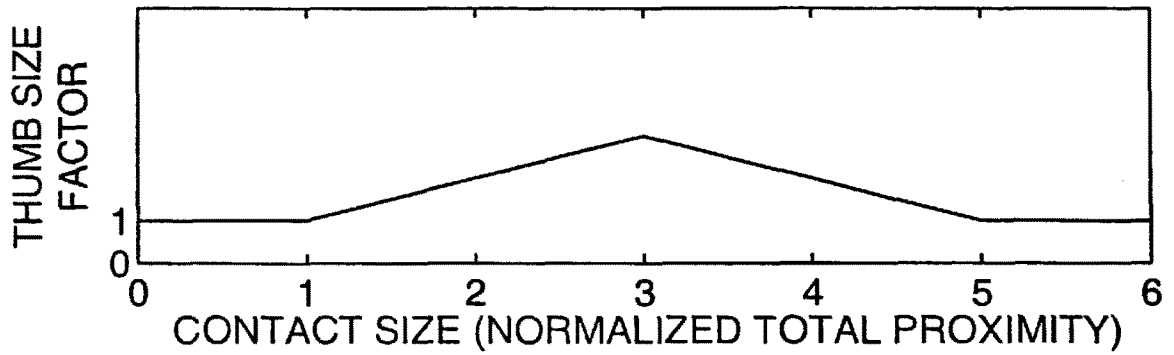

FIG. 25B

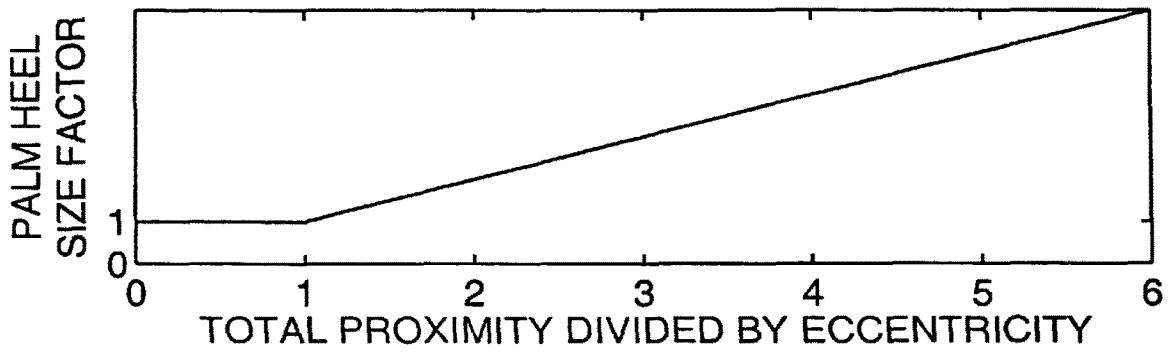

FIG. 25C

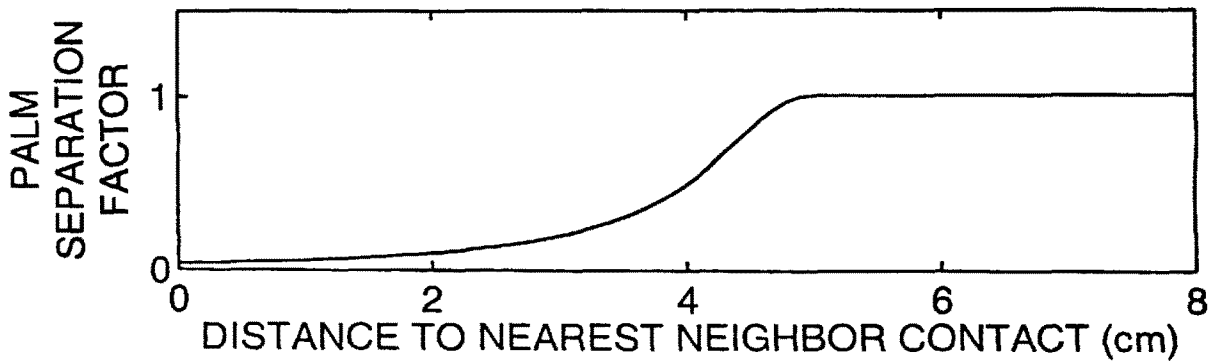

FIG. 25D

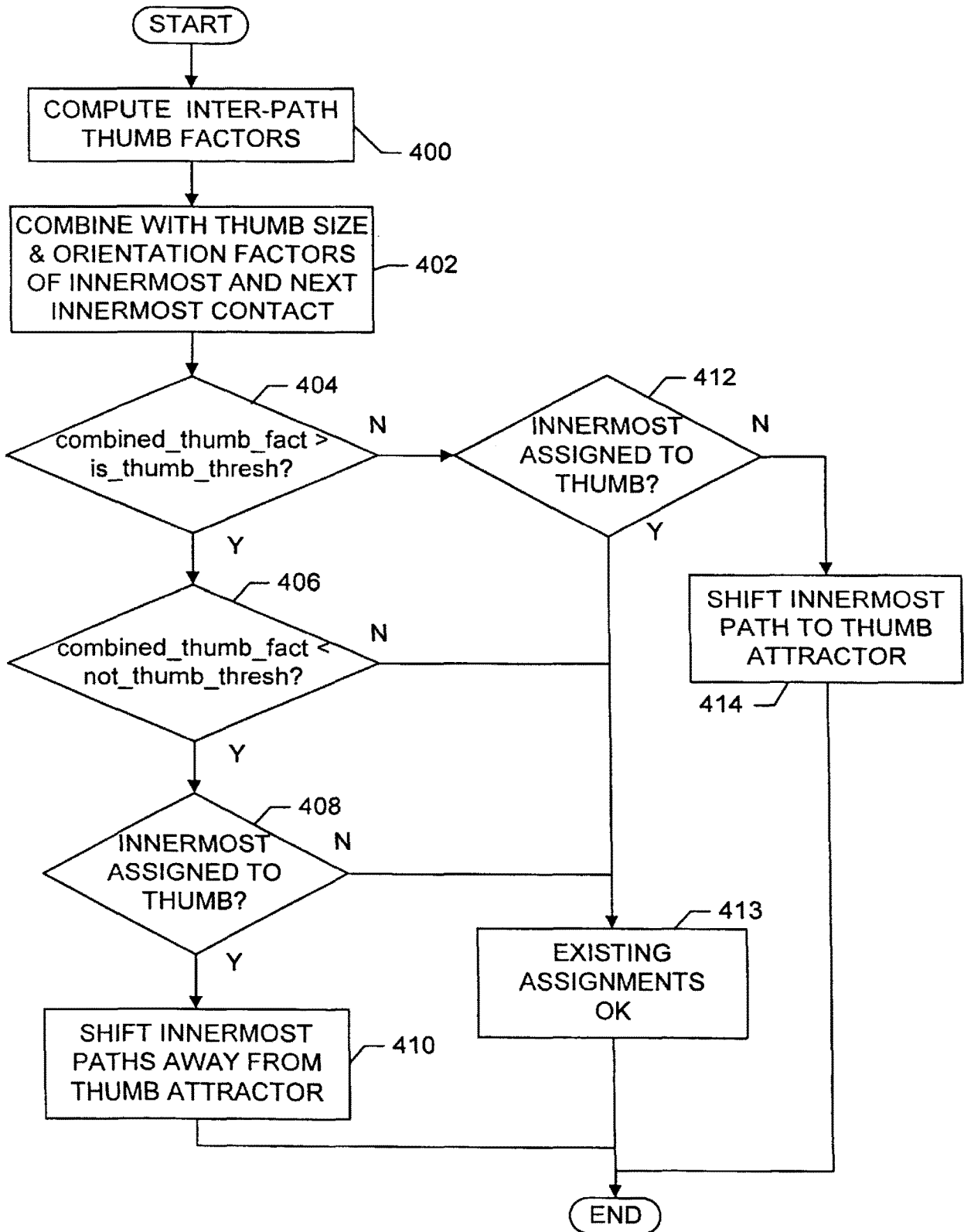

FIG. 26

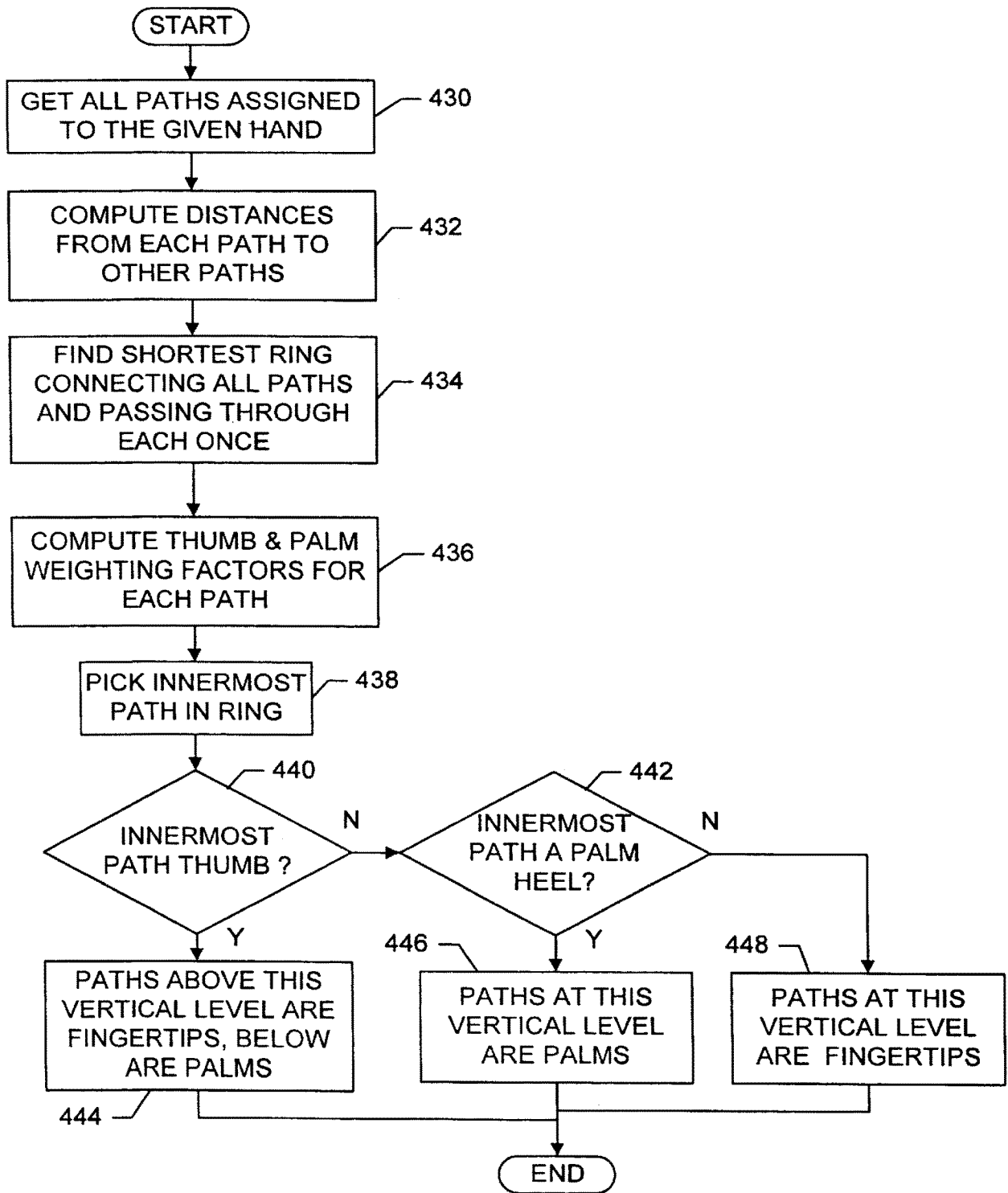

FIG. 27

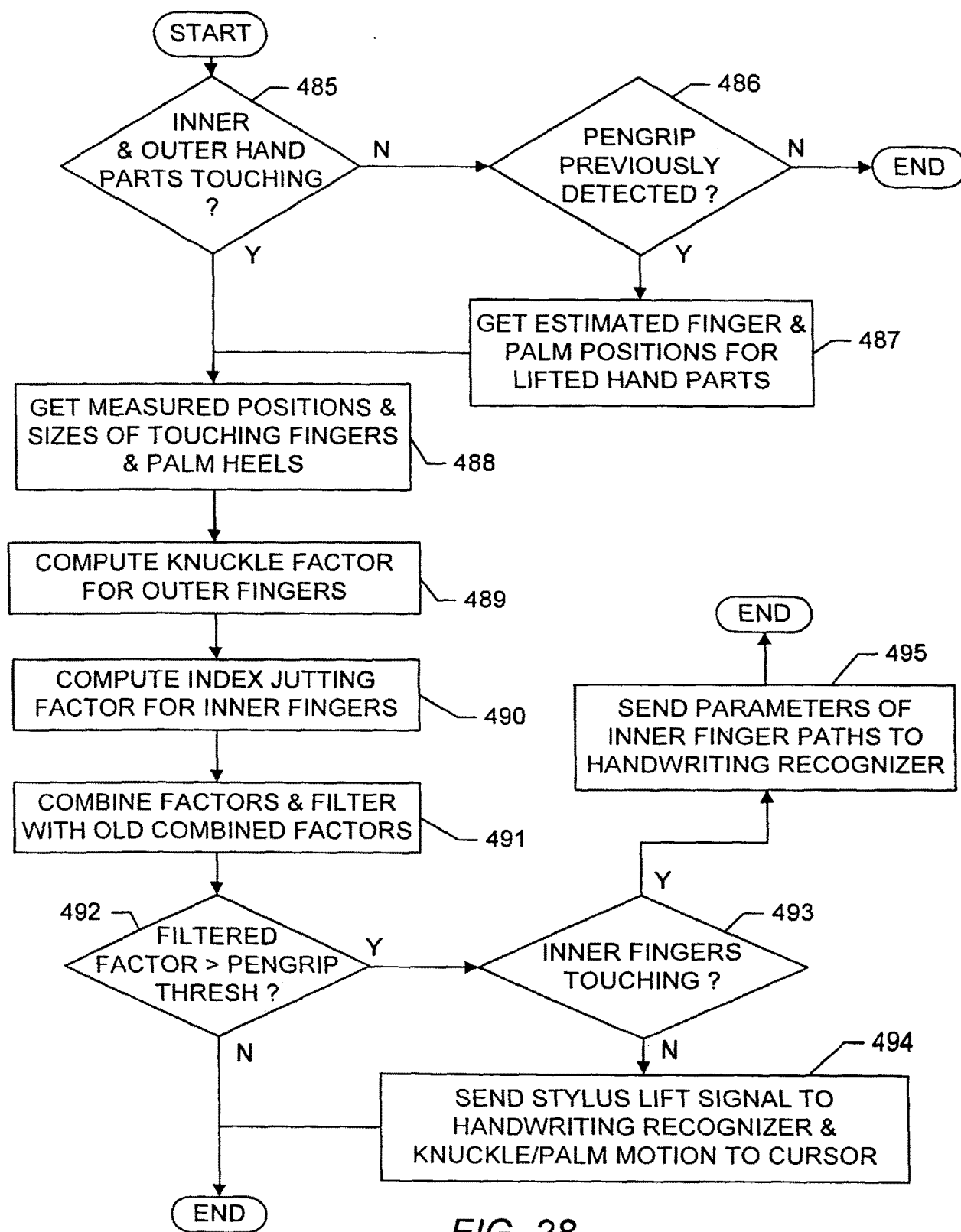

FIG. 28

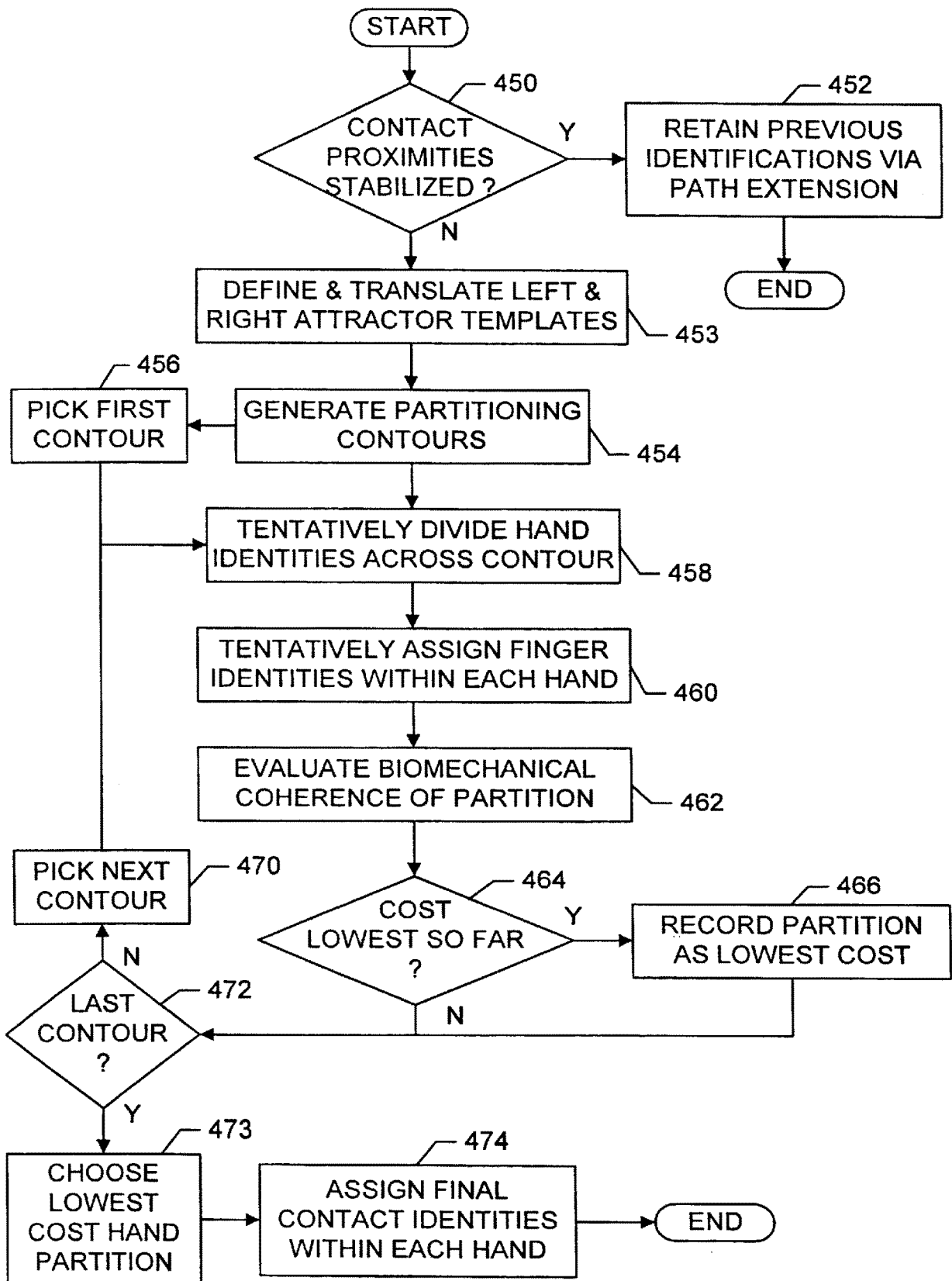

FIG. 29

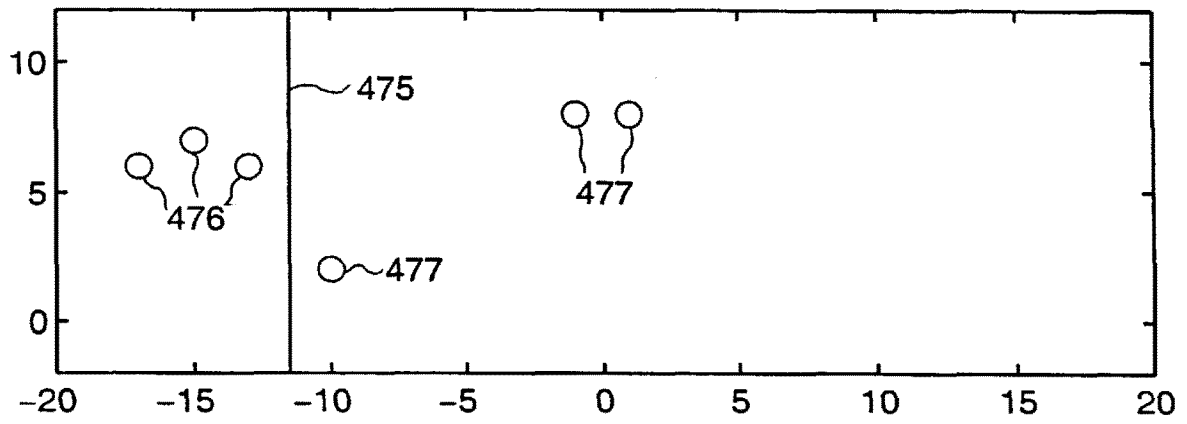

FIG. 30A

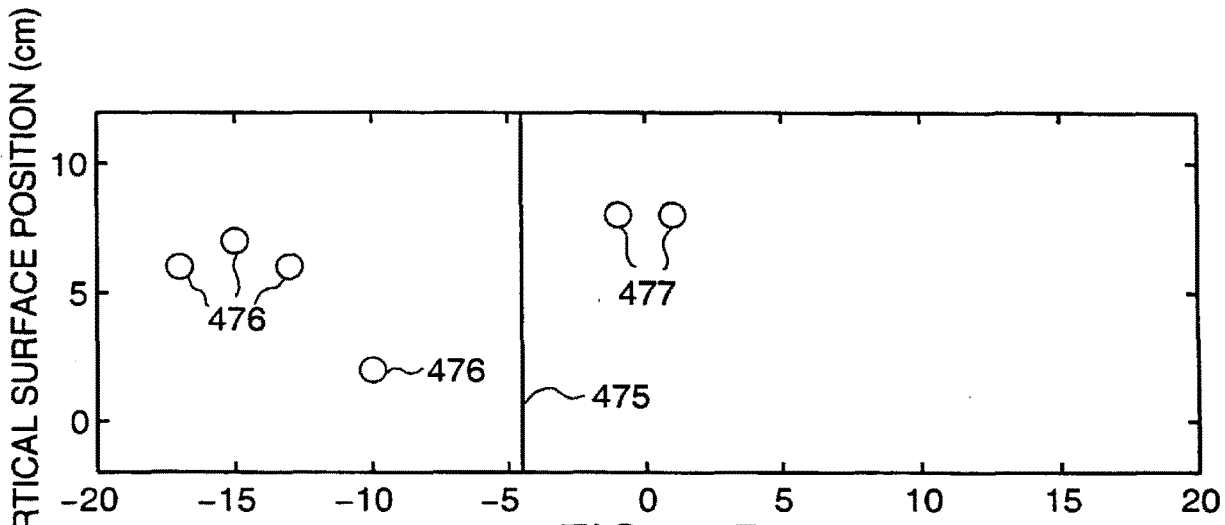

FIG. 30B

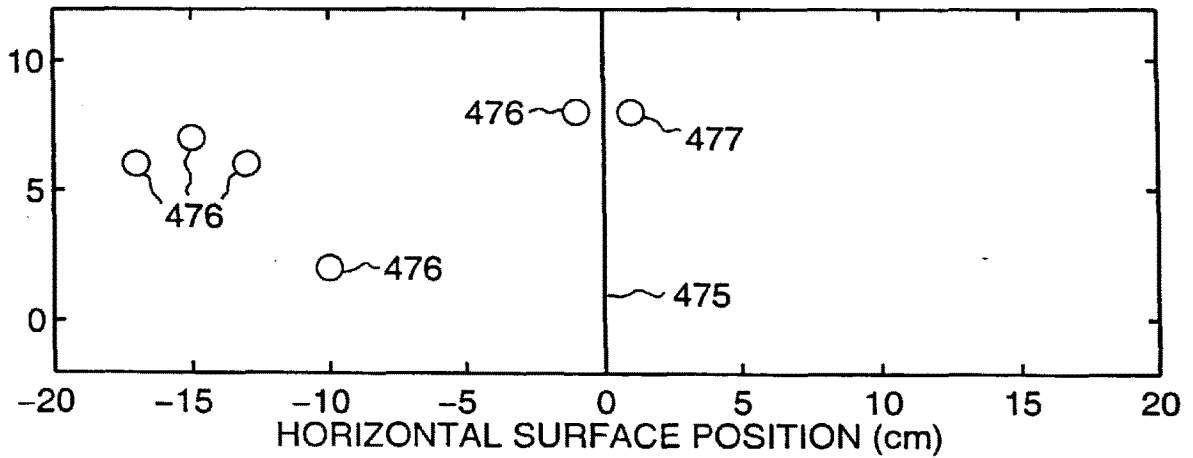

FIG. 30C

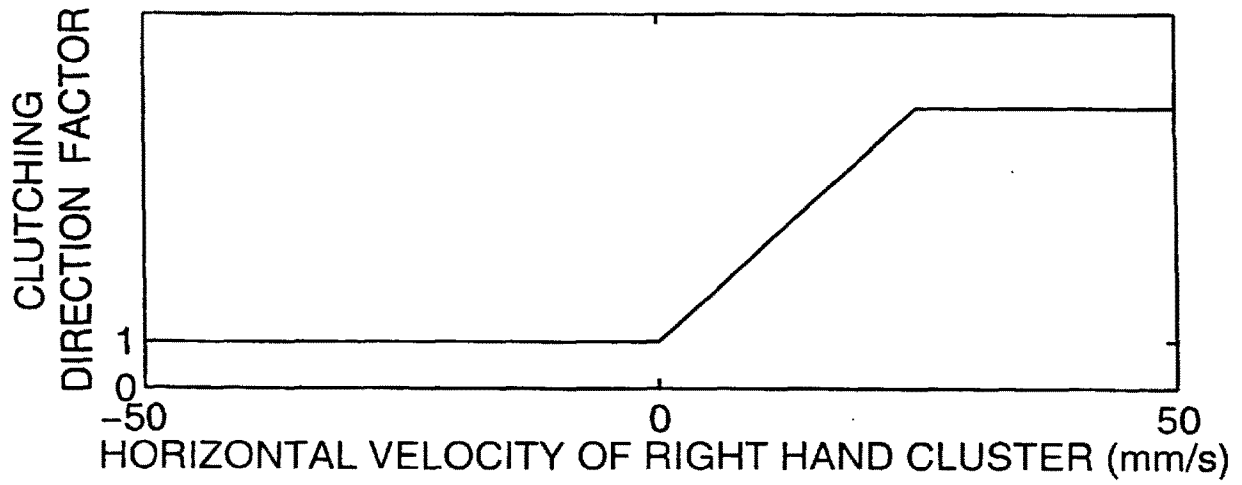

FIG. 31A

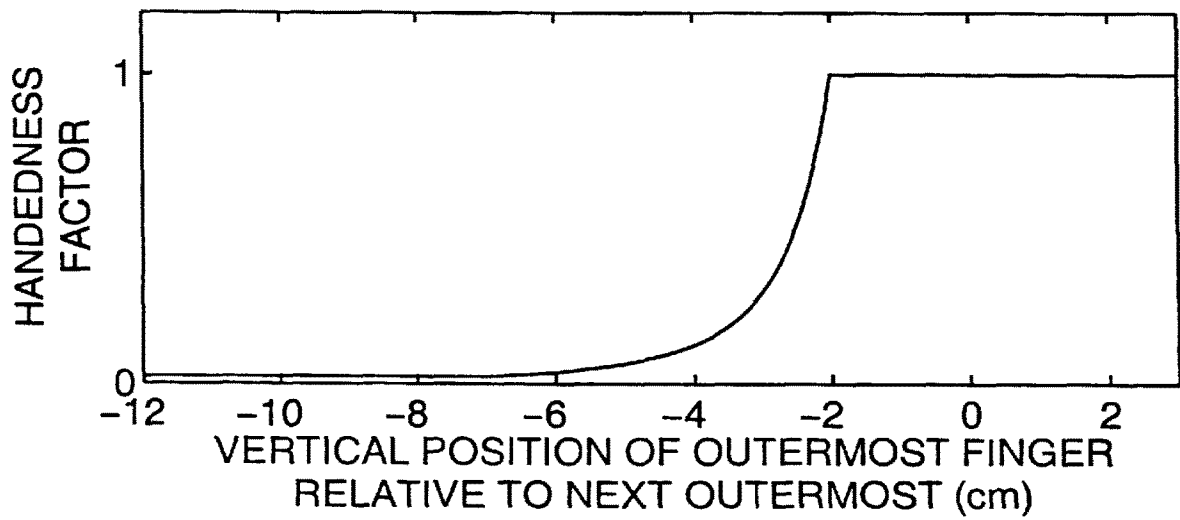

FIG. 31B

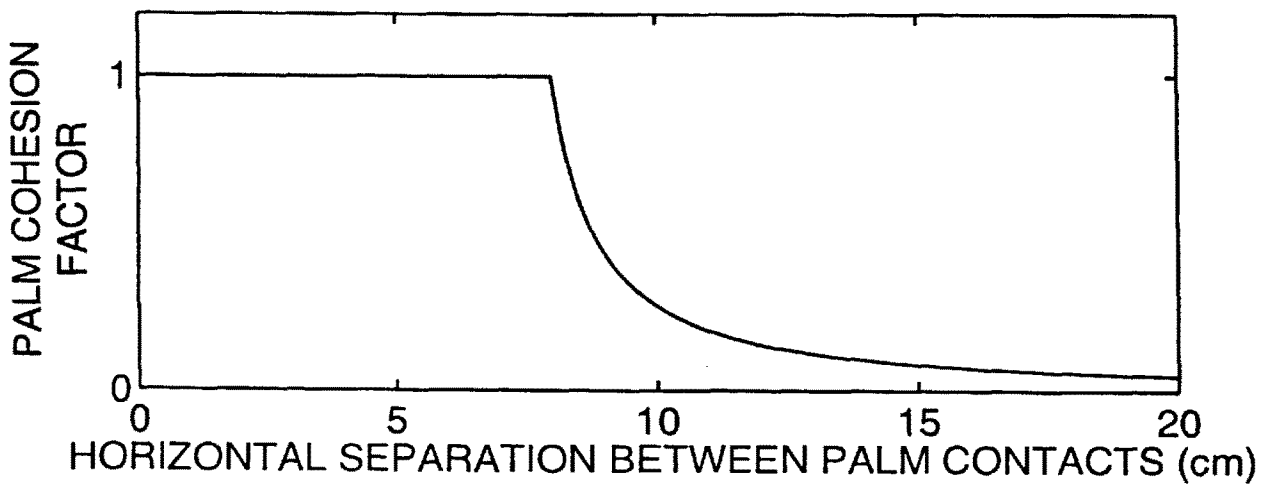

FIG. 31C

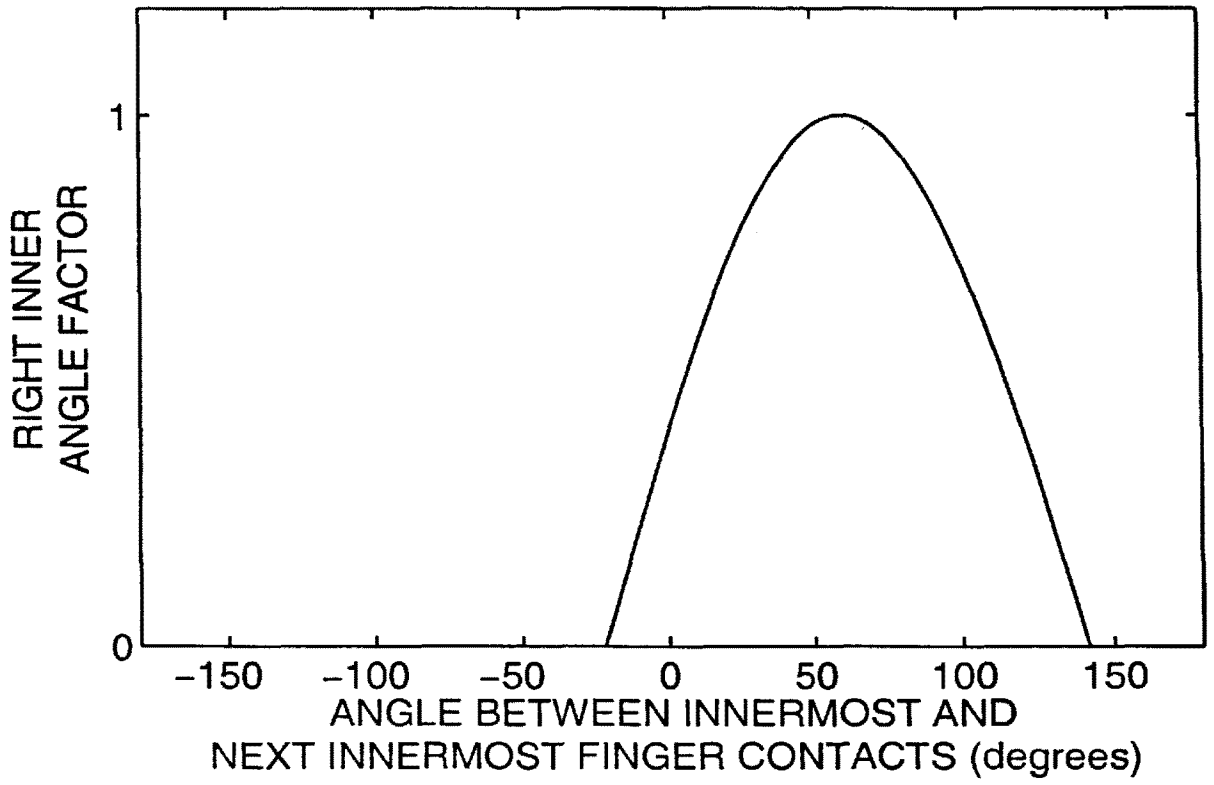

FIG. 32

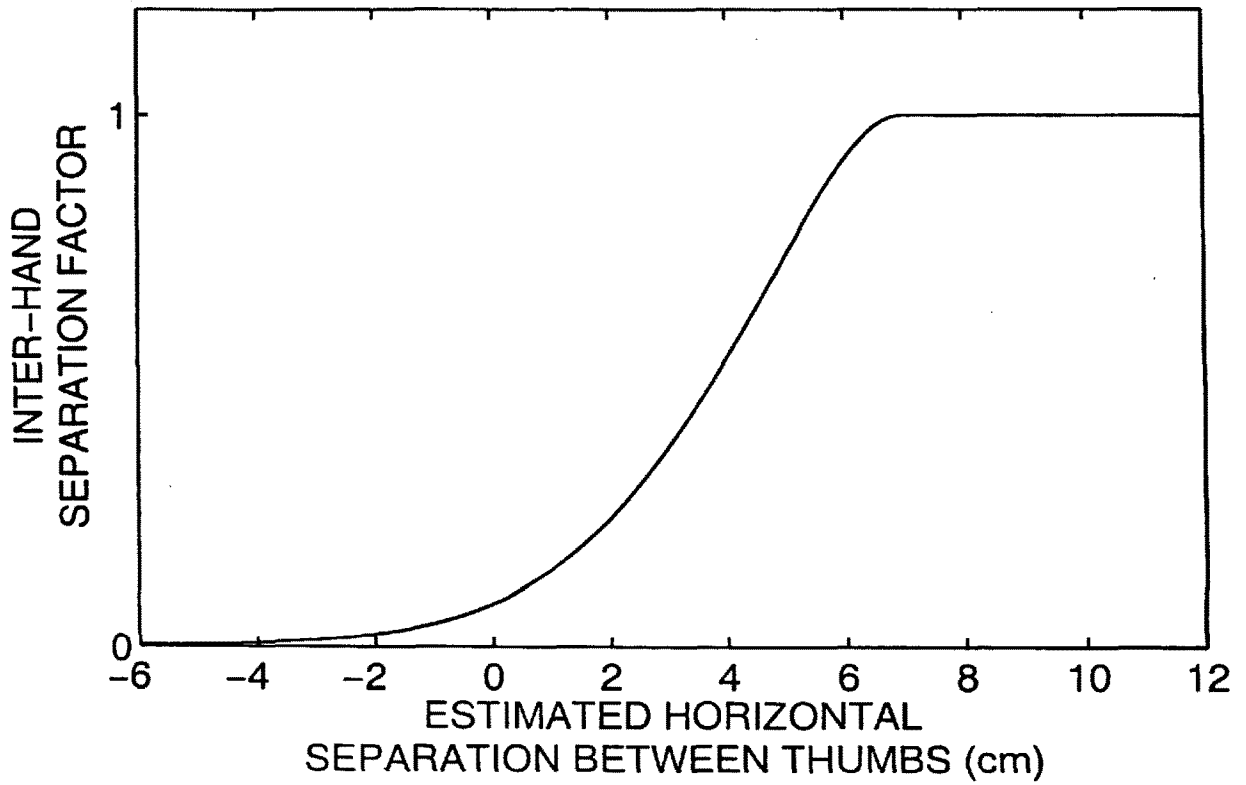

FIG. 33

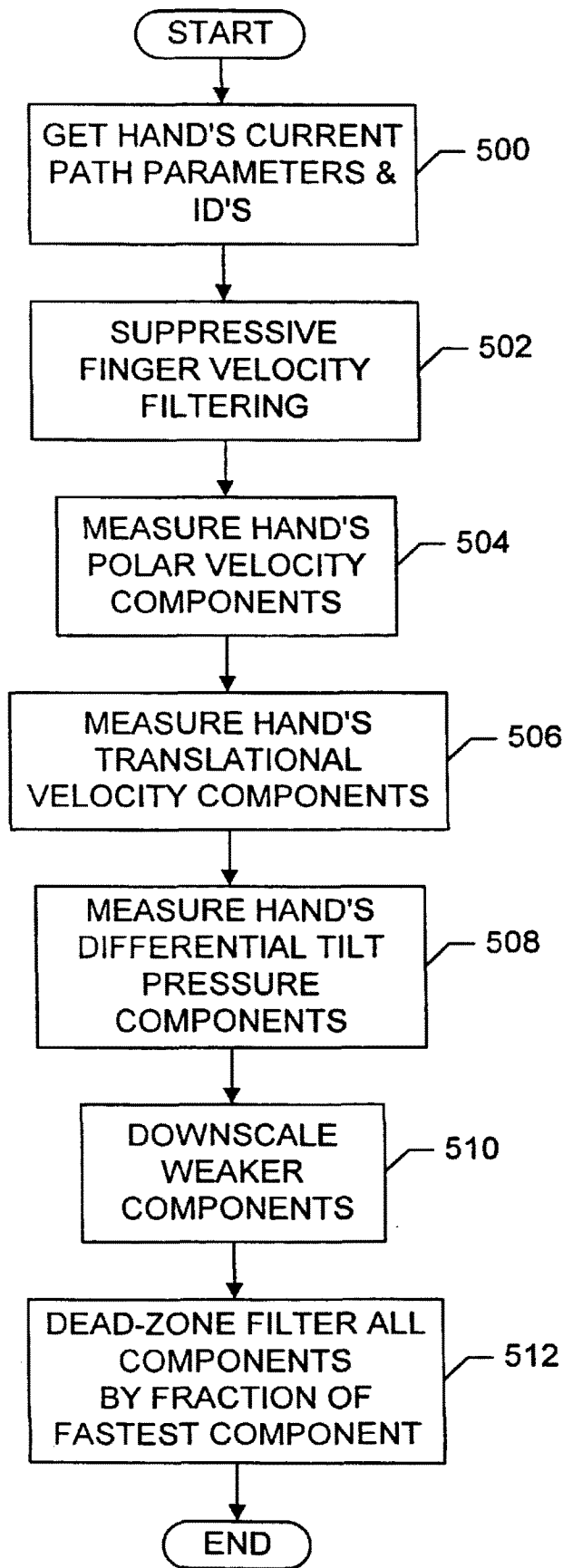

FIG. 34

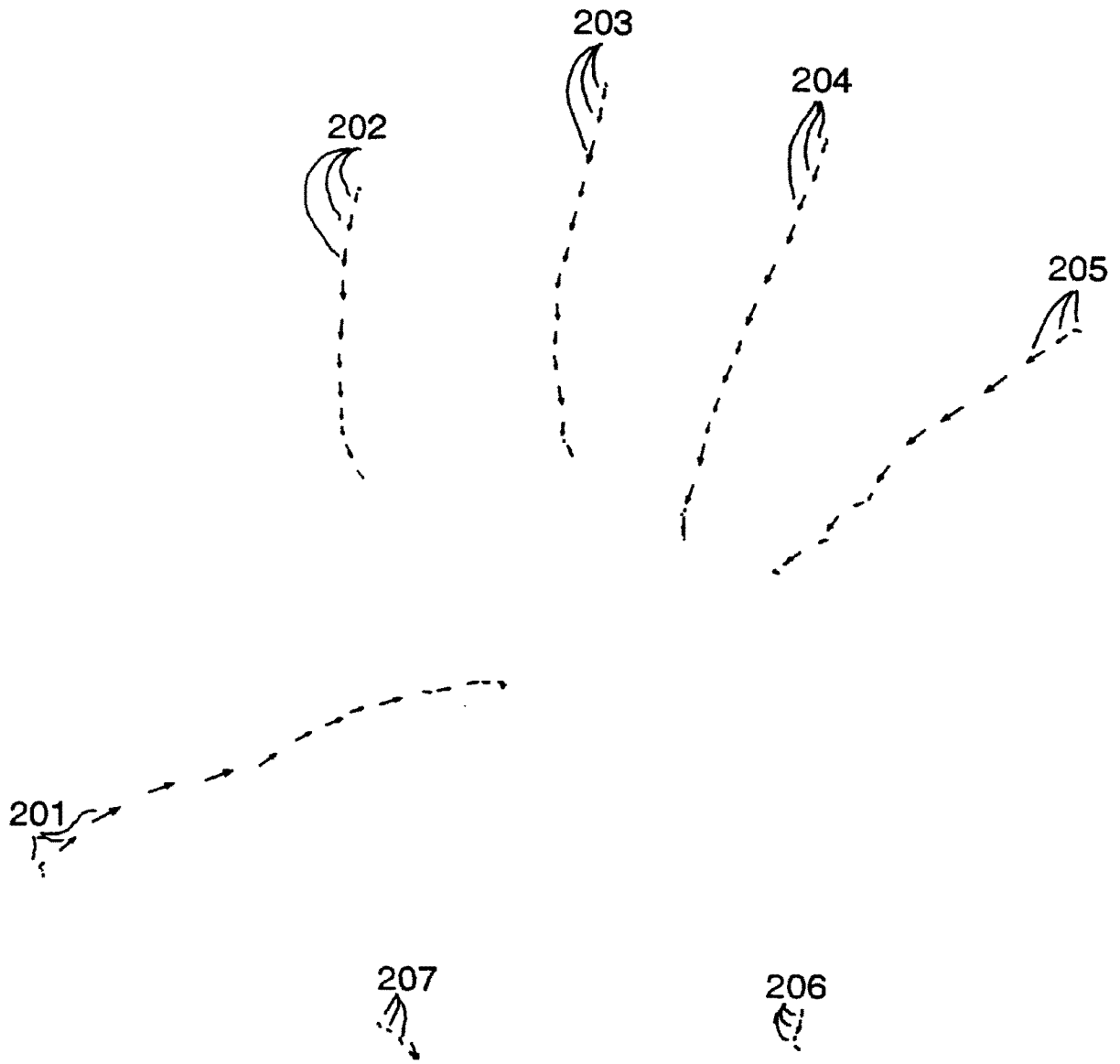

FIG. 35

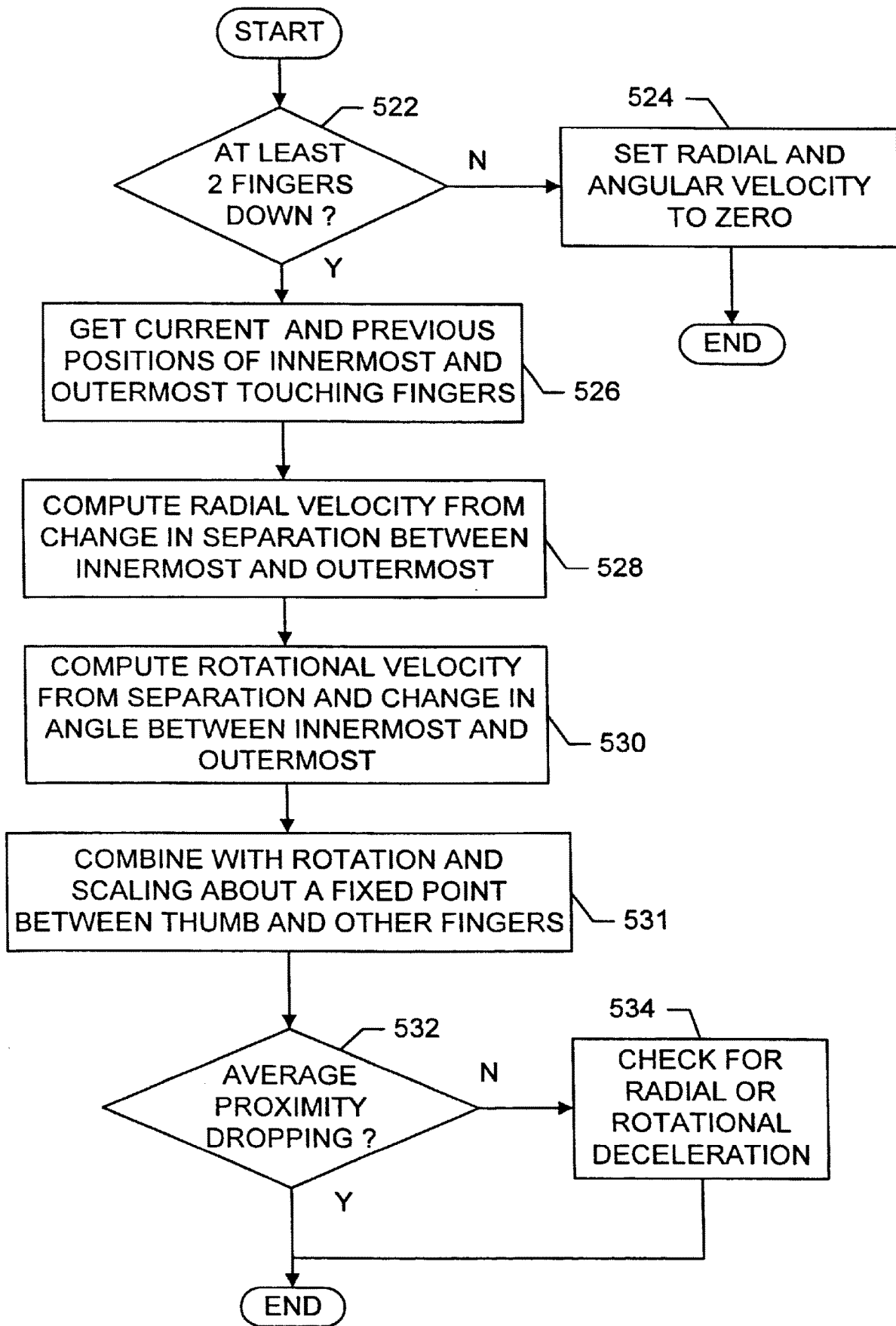

FIG. 36

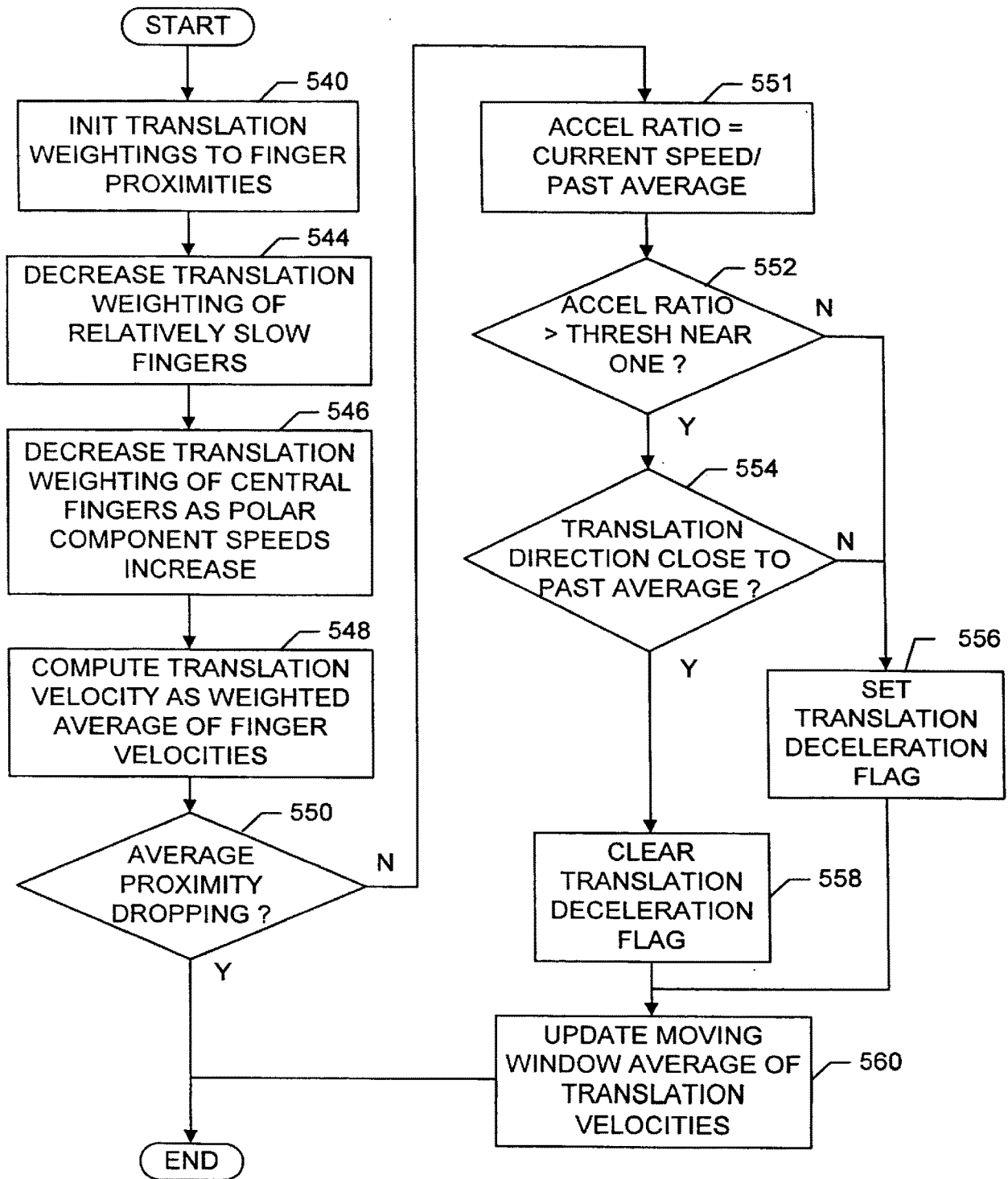

FIG. 37

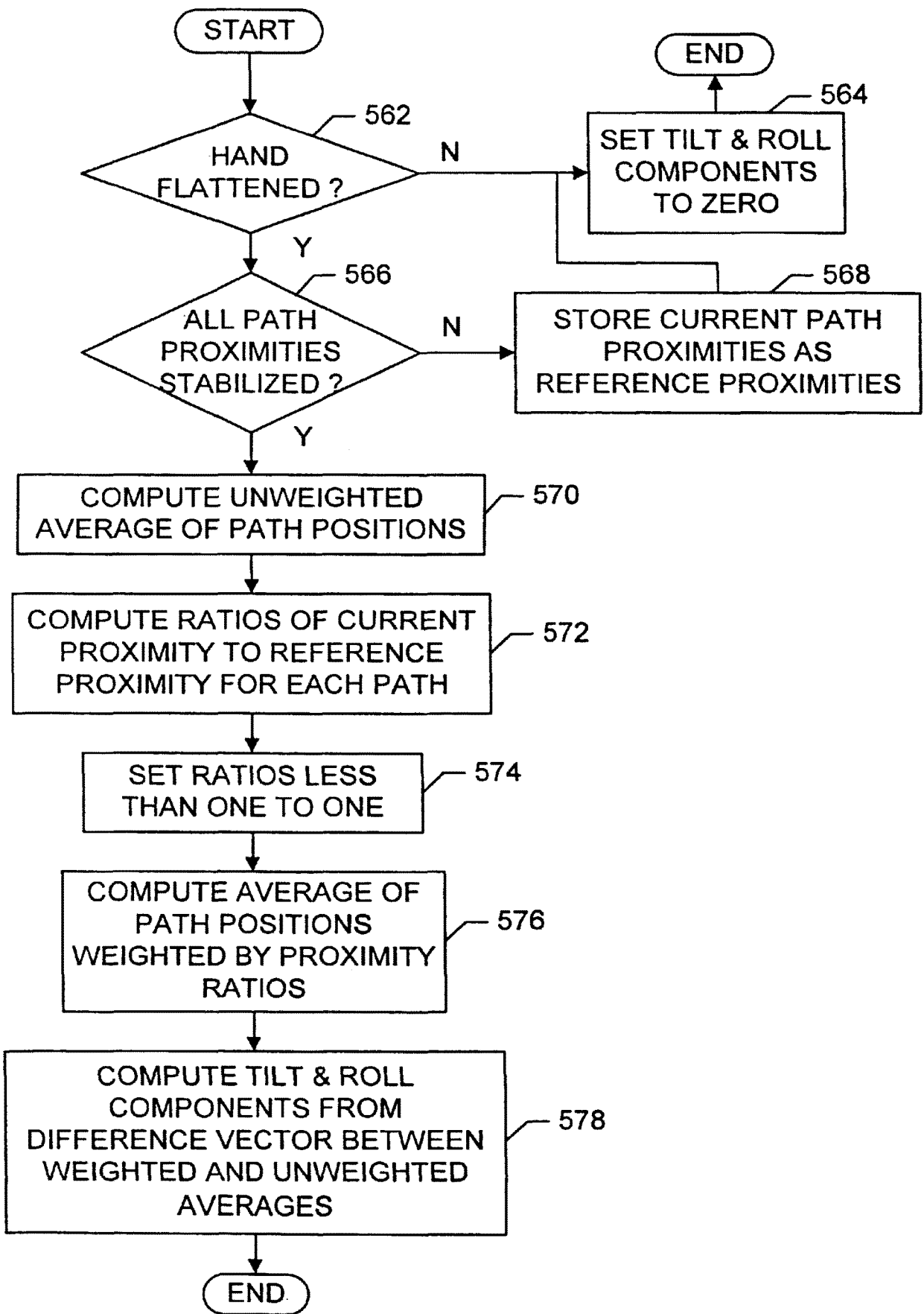

FIG. 38

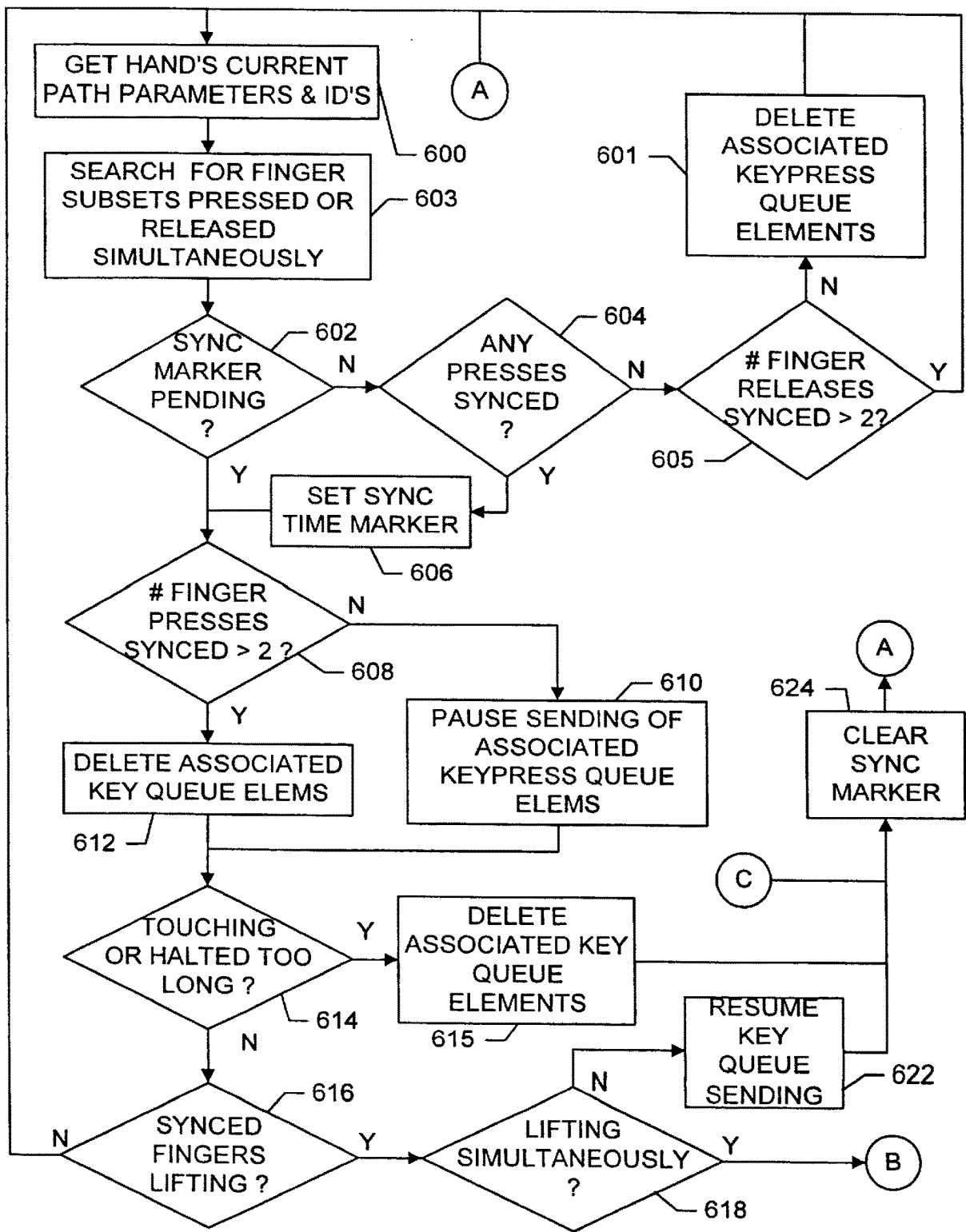

FIG. 39A

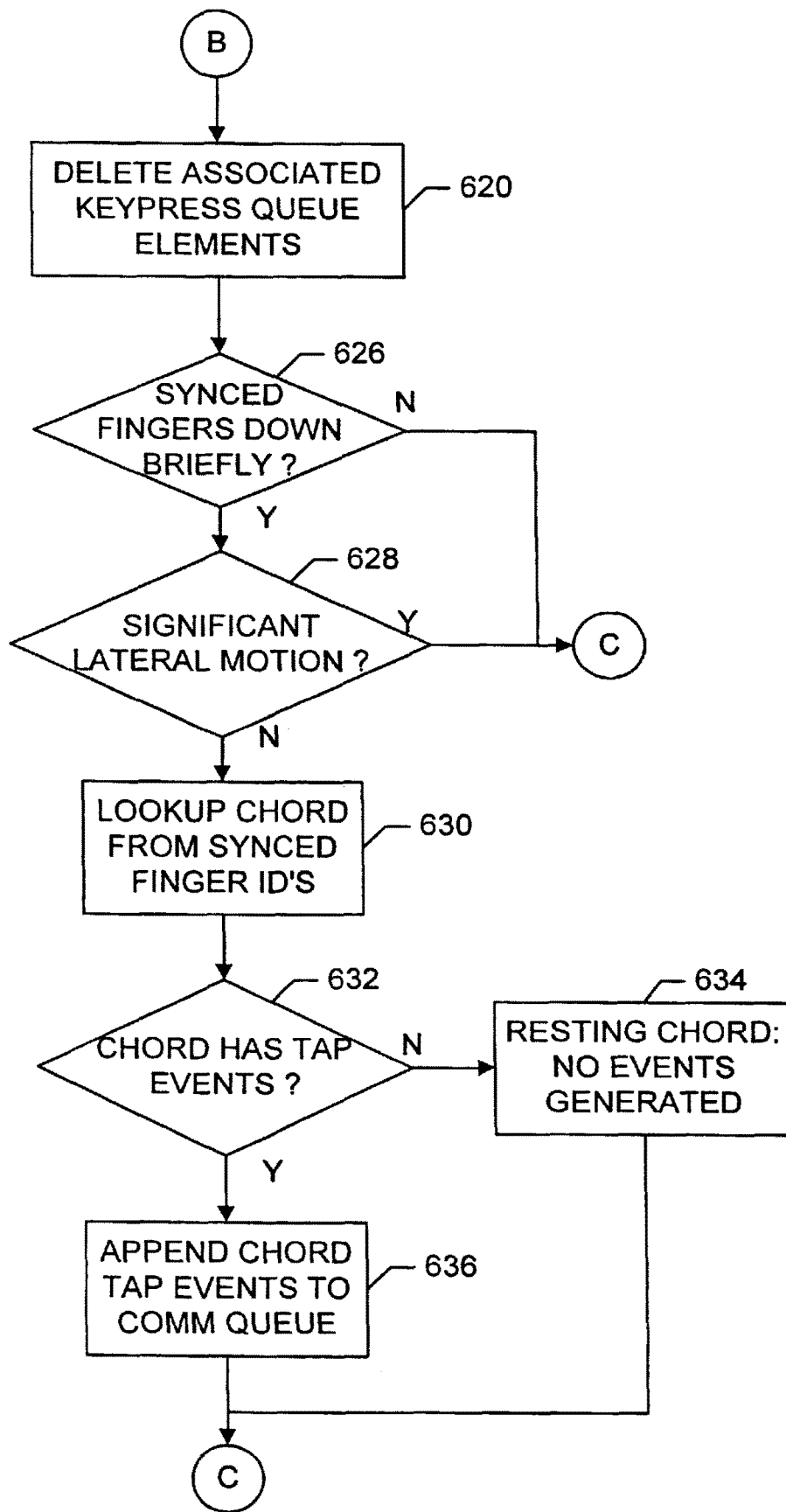

FIG. 39B

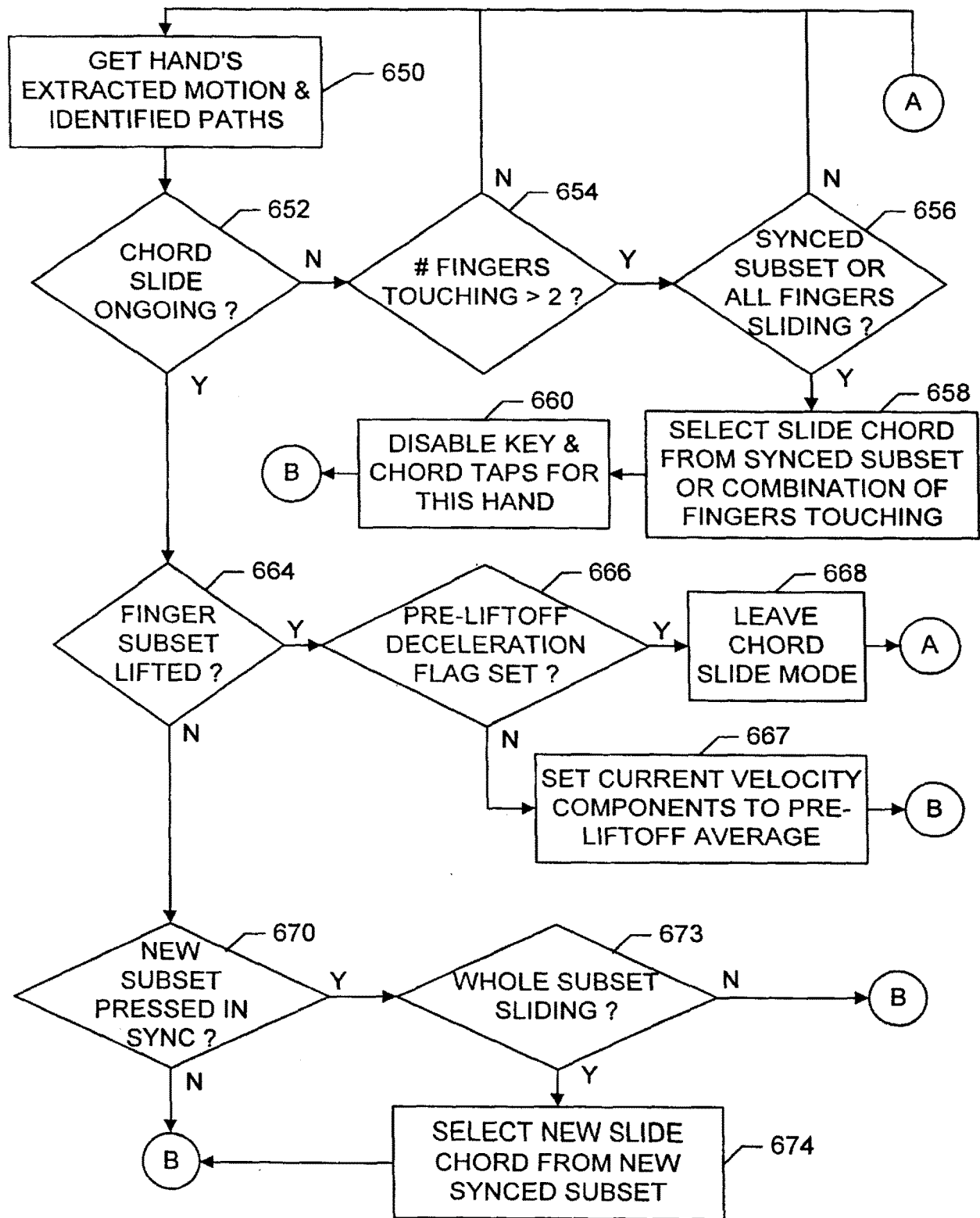

FIG. 40A

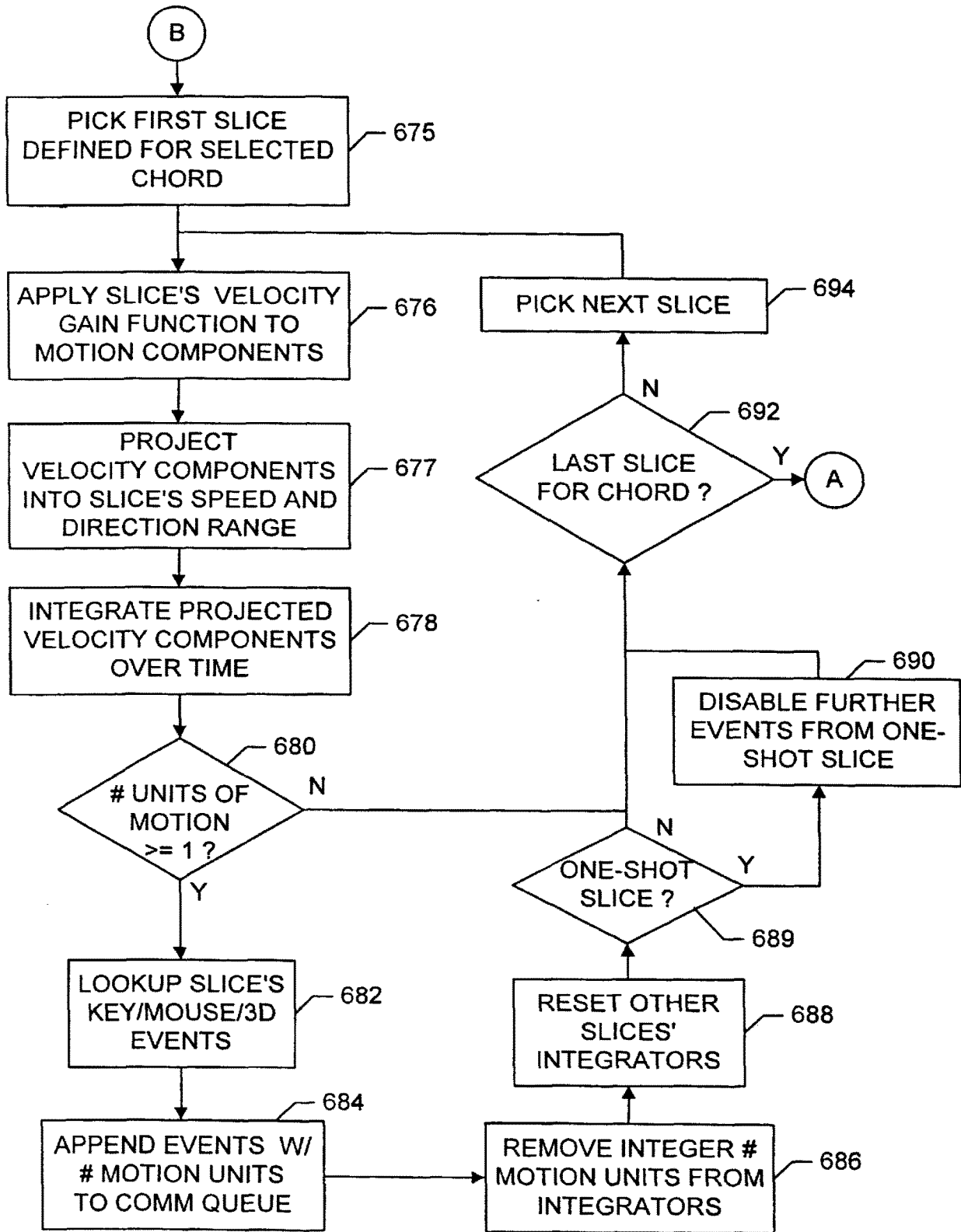

FIG. 40B

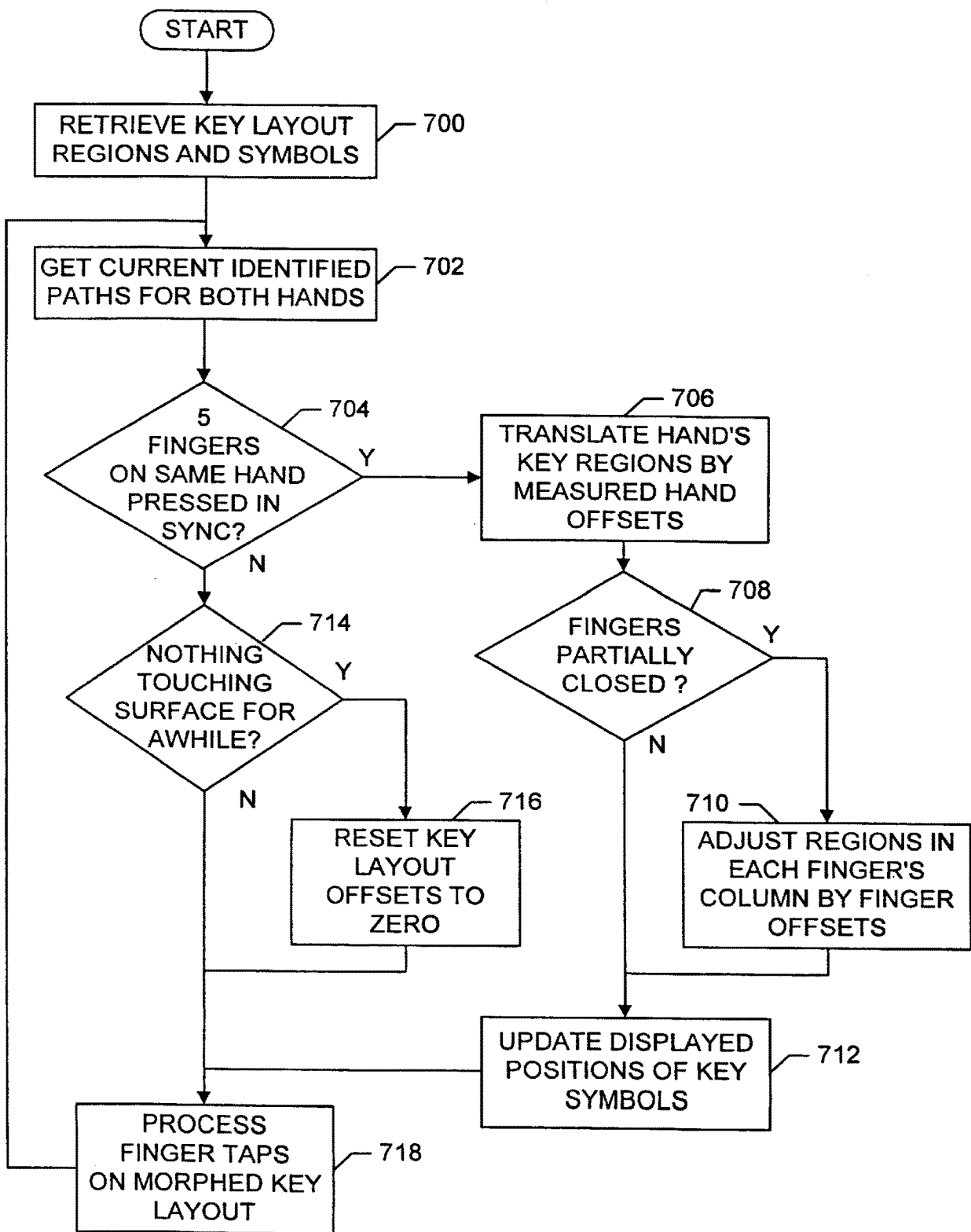

FIG. 41

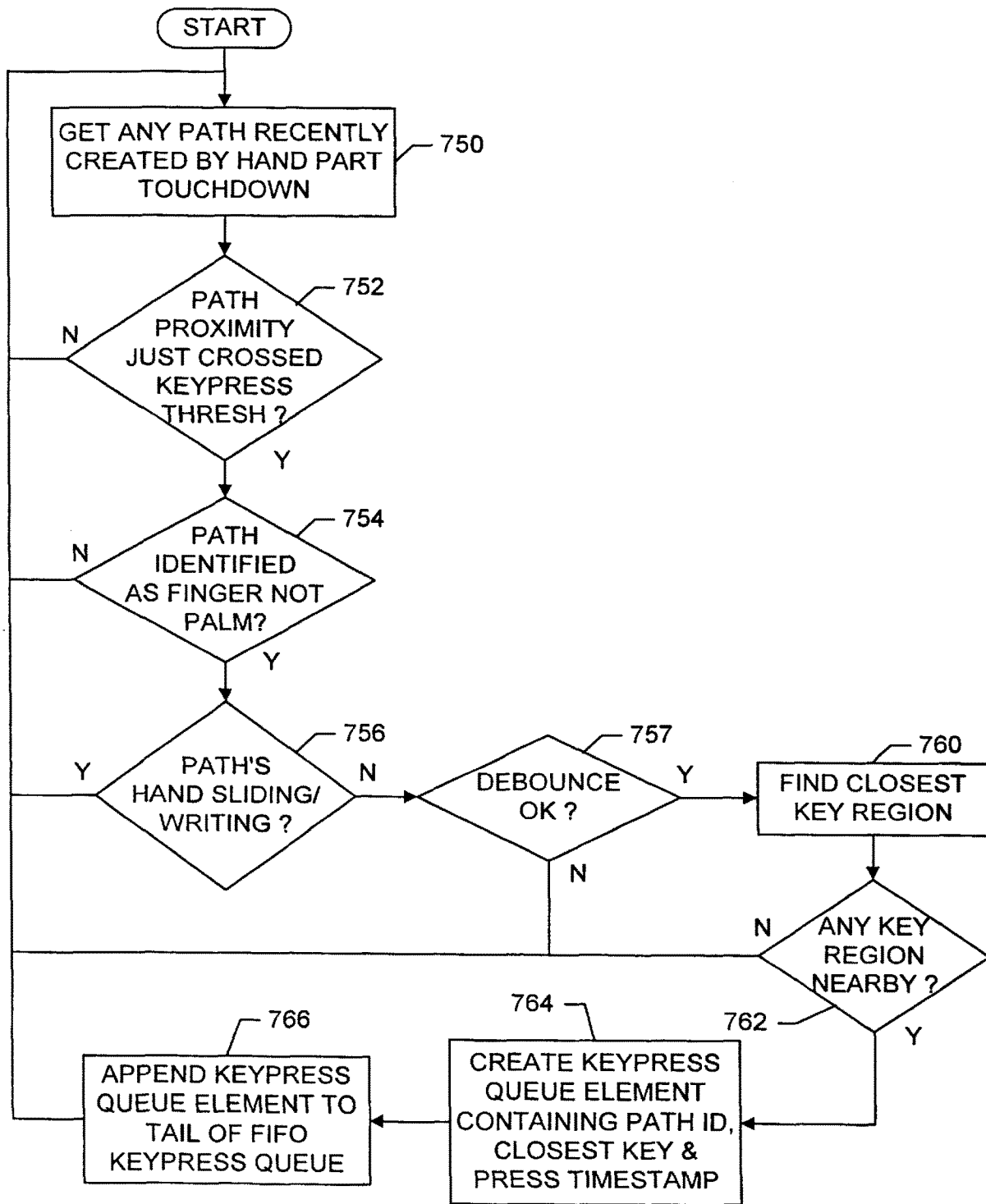

FIG. 42

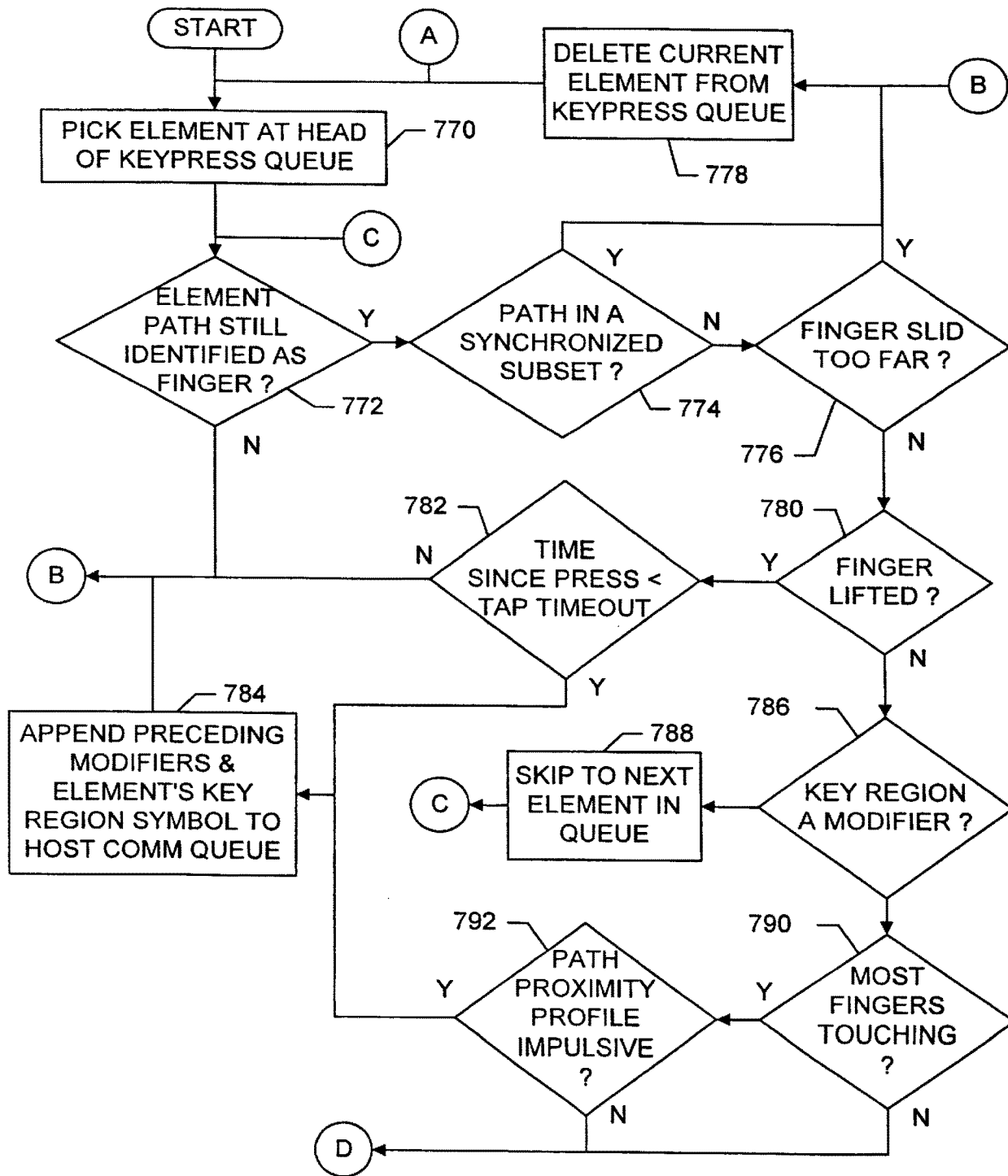

FIG. 43A

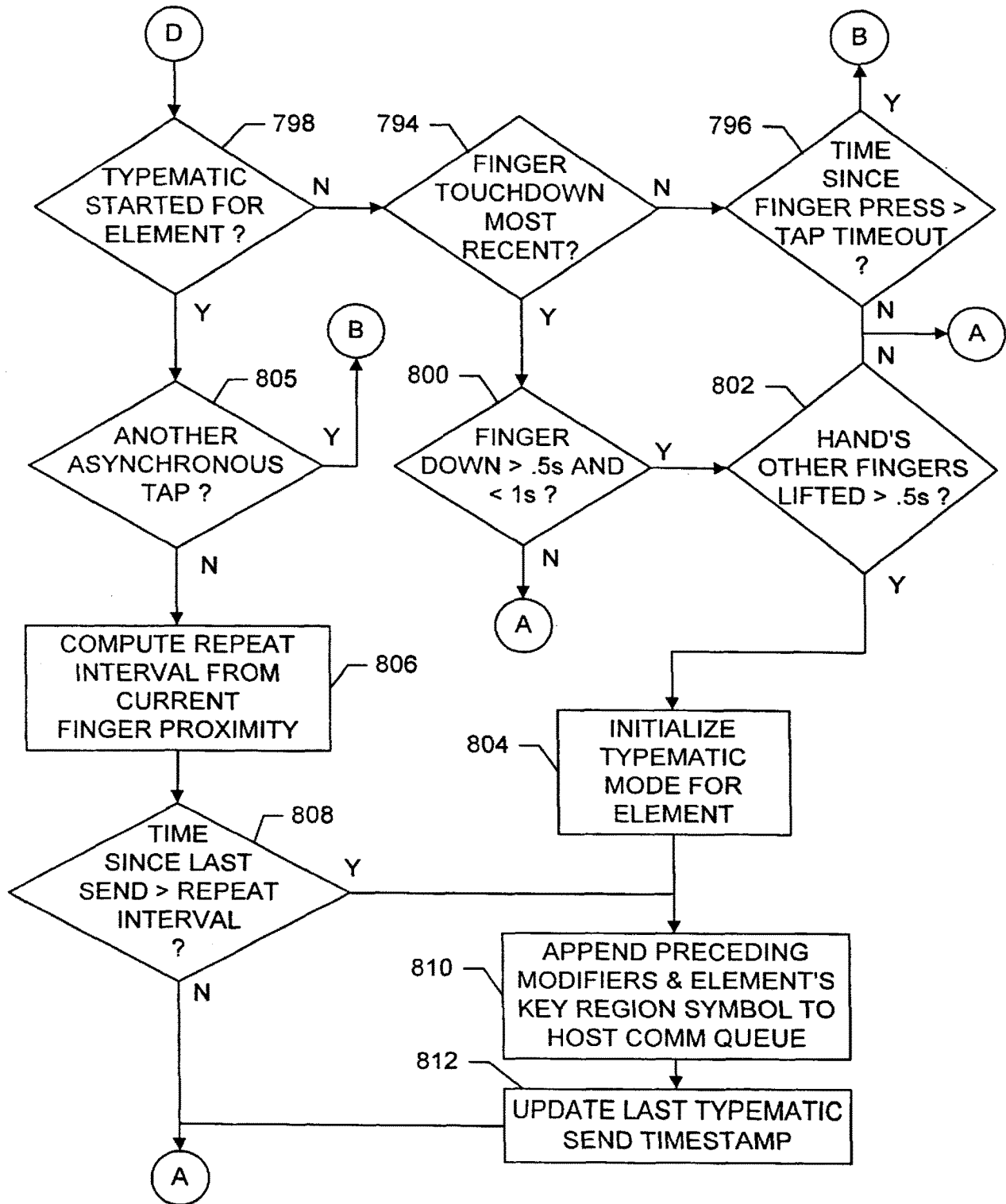

FIG. 43B

APPLICATION FOR UNITED STATES PATENT

ELLIPSE FITTING FOR MULTI-TOUCH SURFACES

INVENTORS

**Wayne Carl WESTERMAN
& John G. ELIAS**

CROSS-REFERENCE TO RELATED APPLICATIONS

[0001] This application is a continuation of 11/015,434, entitled “Method and Apparatus for Integrating Manual Input,” filed December 17, 2004, which is a continuation of 09/236,513 (now Pat. No. 6,323,846) filed January 25, 1999 which claims the benefit of provisional application 60/072,509, filed January 26, 1998, each of which is hereby incorporated by reference in its entirety. This application is also related to Application No. 11/428,501, entitled “Capacitive Sensing Arrangement,” 11/428,503, entitled “Touch Surface,” 11/428,506, entitled “User Interface Gestures,” 11/428,515, entitled “User Interface Gestures”, 11/428,522, entitled “Identifying Contacts on a Touch Surface,” 11/428,521, entitled “Identifying Contacts on a Touch Surface”, 11/428,521, entitled “Multi-Touch Contact Tracking Algorithm”, 11/559,763, “Multi-Touch Contact Motion Extraction,” 11/559,799, entitled “Multi-Touch Contact Motion Extraction,” 11/559,822, entitled “Multi-Touch Contact Motion Extraction,” 11/559,833, entitled Multi-Touch Hand Position Offset Computation, each of which is hereby incorporated by reference in its entirety.

BACKGROUND OF THE INVENTION

A. Field of the Invention

[0002] The present invention relates generally to methods and apparatus for data input, and, more particularly, to a method and apparatus for integrating manual input.

B. Description of the Related Art

[0003] Many methods for manual input of data and commands to computers are in use today, but each is most efficient and easy to use for particular types of data input. For example, drawing tablets with pens or pucks excel at drafting, sketching, and quick command gestures. Handwriting with a stylus is convenient for filling out forms which require signatures, special symbols, or small amounts of text, but handwriting is slow compared to typing and voice input for long documents. Mice, finger-sticks and touchpads excel at cursor pointing and graphical object manipulations such as drag and drop. Rollers, thumbwheels and trackballs excel at panning and scrolling. The diversity of tasks that many computer users encounter in a single day call for all of these techniques, but few users will pay for a multitude of input devices, and the separate devices are often incompatible in a usability and an ergonomic sense. For instance, drawing tablets are a must for graphics professionals, but switching between drawing and typing is inconvenient because the pen must be put down or held awkwardly between the fingers while typing. Thus, there is a long-felt need in the art for a manual input device which is cheap yet offers convenient integration of common manual input techniques.

[0004] Speech recognition is an exciting new technology which promises to relieve some of the input burden on user hands. However, voice is not appropriate for inputting all types of data either. Currently, voice input is best-suited for dictation of long text documents. Until natural language recognition matures sufficiently that very high level voice commands can be understood by the computer, voice will have little advantage over keyboard hot-keys and mouse menus for command and control. Furthermore, precise pointing, drawing, and manipulation of graphical objects is difficult with voice commands, no matter how well speech is understood.

Thus, there will always be a need in the art for multi-function manual input devices which supplement voice input.

[0005] A generic manual input device which combines the typing, pointing, scrolling, and handwriting capabilities of the standard input device collection must have ergonomic, economic, and productivity advantages which outweigh the unavoidable sacrifices of abandoning device specialization. The generic device must tightly integrate yet clearly distinguish the different types of input. It should therefore appear modeless to the user in the sense that the user should not need to provide explicit mode switch signals such as buttonpresses, arm relocations, or stylus pickups before switching from one input activity to another. Epidemiological studies suggest that repetition and force multiply in causing repetitive strain injuries. Awkward postures, device activation force, wasted motion, and repetition should be minimized to improve ergonomics. Furthermore, the workload should be spread evenly over all available muscle groups to avoid repetitive strain.

[0006] Repetition can be minimized by allocating to several graphical manipulation channels those tasks which require complex mouse pointer motion sequences. Common graphical user interface operations such as finding and manipulating a scroll bar or slider control are much less efficient than specialized finger motions which cause scrolling directly, without the step of repositioning the cursor over an on-screen control. Preferably the graphical manipulation channels should be distributed amongst many finger and hand motion combinations to spread the workload. Touchpads and mice with auxilliary scrolling controls such as the Cirque®TM Smartcat touchpad with edge scrolling, the IBM ®TM ScrollPointTM mouse with embedded pointing stick, and the Roller Mouse described in U.S. Pat. No. 5,530,455 to Gillick et al. represent small improvements in this area, but still do not provide enough direct manipulation channels to eliminate many often-used cursor motion sequences. Furthermore, as S. Zhai et al. found in "Dual Stream Input for Pointing and Scrolling," Proceedings of CHI '97 Extended Abstracts (1997), manipulation of more than two degrees of freedom at a time is very difficult with these devices, preventing simultaneous panning, zooming and rotating.

[0007] Another common method for reducing excess motion and repetition is to automatically continue pointing or scrolling movement signals once the user has stopped moving

or lifts the finger. Related art methods can be distinguished by the conditions under which such motion continuation is enabled. In U.S. Pat. No. 4,734,685, Watanabe continues image panning when the distance and velocity of pointing device movement exceed thresholds. Automatic panning is, stopped by moving the pointing device back in the opposite direction, so stopping requires additional precise movements. In U.S. Pat. No. 5,543,591 to Gillespie et al., motion continuation occurs when the finger enters an edge border region around a small touchpad. Continued motion speed is fixed and the direction corresponds to the direction from the center of the touchpad to the finger at the edge. Continuation mode ends when the finger leaves the border region or lifts off the pad. Disadvantageously, users sometimes pause at the edge of the pad without intending for cursor motion to continue, and the unexpected motion continuation becomes annoying. U.S. Pat. No. 5,327,161 to Logan et al. describes motion continuation when the finger enters a border area as well, but in an alternative trackball emulation mode, motion continuation can be a function solely of lateral finger velocity and direction at liftoff. Motion continuation decays due to a friction factor or can be stopped by a subsequent touchdown on the surface. Disadvantageously, touch velocity at liftoff is not a reliable indicator of the user's desire for motion continuation since when approaching a large target on a display at high speeds the user may not stop the pointer completely before liftoff. Thus it would be an advance in the art to provide a motion continuation method which does not become activated unexpectedly when the user really intended to stop pointer movement at a target but happens to be on a border or happens to be moving at significant speed during liftoff.

[0008] Many attempts have been made to embed pointing devices in a keyboard so the hands do not have to leave typing position to access the pointing device. These include the integrated pointing key described in U.S. Pat. No. 5,189,403 to Franz et al., the integrated pointing stick disclosed by J. Rutledge and T. Selker in "Force-to-Motion Functions for Pointing," Human-Computer Interaction--INTERACT '90, pp. 701-06 (1990), and the position sensing keys described in U.S. Pat. No. 5,675,361 to Santilli. Nevertheless, the limited movement range and resolution of these devices, leads to poorer pointing speed and accuracy than a mouse, and they add mechanical complexity to keyboard construction. Thus there exists a need in the art for pointing methods with higher resolution, larger movement range, and more degrees of freedom yet which are easily accessible from typing hand positions.

[0009] Touch screens and touchpads often distinguish pointing motions from emulated button clicks or keypresses by assuming very little lateral fingertip motion will occur during taps on the touch surface which are intended as clicks. Inherent in these methods is the assumption that tapping will usually be straight down from the suspended finger position, minimizing those components of finger motion tangential to the surface. This is a valid assumption if the surface is not finely divided into distinct key areas or if the user does a slow, “hunt and peck” visual search for each key before striking. For example, in U.S. Pat. No. 5,543,591 to Gillespie et al., a touchpad sends all lateral motions to the host computer as cursor movements. However, if the finger is lifted soon enough after touchdown to count as a tap and if the accumulated lateral motions are not excessive, any sent motions are undone and a mouse button click is sent instead. This method only works for mouse commands such as pointing which can safely be undone, not for dragging or other manipulations. In U.S. Pat. No. 5,666,113 to Logan, taps with less than about $1/16$ ” lateral motion activate keys on a small keypad while lateral motion in excess of $1/16$ ” activates cursor control mode. In both patents cursor mode is invoked by default when a finger stays on the surface a long time.

[0010] However, fast touch typing on a surface divided into a large array of key regions tends to produce more tangential motions along the surface than related art filtering techniques can tolerate. Such an array contains keys in multiple rows and columns which may not be directly under the fingers, so the user must reach with the hand or flex or extend fingers to touch many of the key regions. Quick reaching and extending imparts significant lateral finger motion while the finger is in the air which may still be present when the finger contacts the surface. Glancing taps with as much as $1/4$ ” lateral motion measured at the surface can easily result. Attempting to filter or suppress this much motion would make the cursor seem sluggish and unresponsive. Furthermore, it may be desirable to enter a typematic or automatic key repeat mode instead of pointing mode when the finger is held in one place on the surface. Any lateral shifting by the fingertip during a prolonged finger press would also be picked up as cursor jitter without heavy filtering. Thus, there is a need in the art for a method to distinguish keying from pointing on the same surface via more robust hand configuration cues than lateral motion of a single finger.

[0011] An ergonomic typing system should require minimal key tapping force, easily distinguish finger taps from resting hands, and cushion the fingers from the jarring force of surface impact. Mechanical and membrane keyboards rely on the spring force in the keyswitches to prevent activation when the hands are resting on the keys. This causes an irreconcilable tradeoff between the ergonomic desires to reduce the fatigue from key activating force and to relax the full weight of the hands onto the keys during rest periods. Force minimization on touch surfaces is possible with capacitive or active optical sensing, which do not rely on finger pressure, rather than resistive-membrane or surface-acoustic-wave sensing techniques. The related art touch devices discussed below will become confused if a whole hand including its four fingertips a thumb and possibly palm heels, rests on the surface. Thus, there exists a long felt need in the art for a multi-touch surface typing system based on zero-force capacitive sensing which can tolerate resting hands and a surface cushion.

[0012] An ergonomic typing system should also adapt to individual hand sizes tolerate variations in typing style, and support a range of healthy hand postures. Though many ergonomic keyboards have been proposed, mechanical keyswitches can only be repositioned at great cost. For example, the keyboard with concave keywells described by Hargreaves et al. in U.S. Pat. No. 5,689,253 fits most hands well but also tends to lock the arms in a single position. A touch surface key layout could easily be morphed, translated, or arbitrarily reconfigured as long as the changes did not confuse the user. However, touch surfaces may not provide as much laterally orienting tactile feedback as the edges of mechanical keyswitches. Thus, there exists a need in the art for a surface typing recognizer which can adapt a key layout to fit individual hand postures and which can sustain typing accuracy if the hands drift due to limited tactile feedback.

[0013] Handwriting on smooth touch surfaces using a stylus is well-known in the art, but it typically does not integrate well with typing and pointing because the stylus must be put down somewhere or held awkwardly during other input activities. Also, it may be difficult to distinguish the handwriting activity of the stylus from pointing motions of a fingertip. Thus there exists a need in the art for a method to capture coarse handwriting gestures without a stylus and without confusing them with pointing motions.

[0014] Many of the input differentiation needs cited above could be met with a touch sensing technology which distinguishes a variety of hand configurations and motions such as sliding finger chords and grips. Many mechanical chord keyboards have been designed to detect simultaneous downward activity from multiple fingers, but they do not detect lateral finger motion over a large range. Related art shows several examples of capacitive touchpads which emulate a mouse or keyboard by tracking a single finger. These typically measure the capacitance of or between elongated wires which are laid out in rows and columns. A thin dielectric is interposed between the row and column layers. Presence of a finger perturbs the self or mutual capacitance for nearby electrodes. Since most of these technologies use projective row and column sensors which integrate on one electrode the proximity of all objects in a particular row or column, they cannot uniquely determine the positions of two or more objects as discussed in S. Lee, "A Fast Multiple-Touch-Sensitive Input Device," University of Toronto Masters Thesis (1984). The best they can do is count fingertips which happen to lie in a straight row, and even that will fail if a thumb or palm is introduced in the same column as a fingertip.

[0015] In U.S. Pat. Nos. 5,565,658 and 5,305,017, Gerpheide et al. measure the mutual capacitance between row and column electrodes by driving one set of electrodes at some clock frequency and sensing how much of that frequency is coupled onto a second electrode set. Such synchronous measurements are very prone to noise at the driving frequency, so to increase signal-to-noise ratio they form virtual electrodes comprised of multiple rows or multiple columns, instead of a single row and column, and scan through electrode combinations until the various mutual capacitances are nulled or balanced. The coupled signal increases with the product of the rows and columns in each virtual electrodes, but the noise only increases with the sum, giving a net gain in signal-to-noise ratio for virtual electrodes consisting of more than two rows and two columns. However, to uniquely distinguish multiple objects, virtual electrode sizes would have to be reduced so the intersection of the row and column virtual electrodes would be no larger than a finger tip, *i.e.*, about two rows and two columns, which will degrade the signal-to-noise ratio. Also, the signal-to-noise ratio drops as row and column lengths increase to cover a large area.

[0016] In U.S. Pat. Nos. 5,543,591, 5,543,590, and 5,495,077, Gillespie et al measure the electrode-finger self-capacitance for row and column electrodes independently. Total electrode capacitance is estimated by measuring the electrode voltage change caused by injecting or removing a known amount of charge in a known time. All electrodes can be measured simultaneously if each electrode has its own drive/sense circuit. The centroid calculated from all row and column electrode signals establishes an interpolated vertical and horizontal position for a single object. This method may in general have higher signal-to-noise ratio than synchronous methods, but the signal-to-noise ratio is still degraded as row and column lengths increase. Signal-to-noise ratio is especially important for accurately locating objects which are floating a few millimeters above the pad. Though this method can detect such objects, it tends to report their position as being near the middle of the pad, or simply does not detect floating objects near the edges.

[0017] Thus there exists a need in the art for a capacitance-sensing apparatus which does not suffer from poor signal-to-noise ratio and the multiple finger indistinguishability problems of touchpads with long row and column electrodes.

[0018] U.S. Pat. No. 5,463,388 to Boie et al. has a capacitive sensing system applicable to either keyboard or mouse input, but does not consider the problem of integrating both types of input simultaneously. Though they mention independent detection of arrayed unit-cell electrodes, their capacitance transduction circuitry appears too complex to be economically reproduced at each electrode. Thus the long lead wires connecting electrodes to remote signal conditioning circuitry can pickup noise and will have significant capacitance compared to the finger-electrode self-capacitance, again limiting signal-to-noise ratio. Also, they do not recognize the importance of independent electrodes for multiple finger tracking, or mention how to track multiple fingers on an independent electrode array.

[0019] Lee built an early multi-touch electrode array, with 7 mm by 4 mm metal electrodes arranged in 32 rows and 64 columns. The “Fast Multiple-Touch-Sensitive Input Device (FMTSID)” total active area measured 12” by 16”, with a 0.075 mm Mylar dielectric to insulate fingers from electrodes. Each electrode had one diode connected to a row charging line and a second diode connected to a column discharging line. Electrode capacitance changes were

measured singly or in rectangular groups by raising the voltage on one or more row lines, selectively charging the electrodes in those rows, and then timing the discharge of selected columns to ground through a discharge resistor. Lee's design required only two diodes per electrode, but the principal disadvantage of Lee's design is that the column diode reverse bias capacitances allowed interference between electrodes in the same column.

[0020] All of the related capacitance sensing art cited above utilize interpolation between electrodes to achieve high pointing resolution with economical electrode density. Both Boie et al. and Gillespie et al. discuss computation of a centroid from all row and column electrode readings. However, for multiple finger detection, centroid calculation must be carefully limited around local maxima to include only one finger at a time. Lee utilizes a bisection search technique to find local maxima and then interpolates only on the eight nearest neighbor electrodes of each local maximum electrode. This may work fine for small fingertips, but thumb and palm contacts may cover more than nine electrodes. Thus there exists a need in the art for improved means to group exactly those electrodes which are covered by each distinguishable hand contact and to compute a centroid from such potentially irregular groups.

[0021] To take maximum advantage of multi-touch surface sensing, complex proximity image processing is necessary to track and identify the parts of the hand contacting the surface at any one time. Compared to passive optical, images, proximity images provide clear indications of where the body contacts the surface, uncluttered by luminosity variation and extraneous objects in the background. Thus proximity image filtering and segmentation stages can be simpler and more reliable than in computer vision approaches to free-space hand tracking such as S. Alimad, "A Usable Real-Time 3D Hand Tracker," Proceedings of the 28th Asilomar Conference on Signals, Systems, and Computers--Part 2, vol. 2, IEEE (1994) or Y. Cui and J. Wang, "Hand Segmentation Using Learning-Based Prediction and Verification for Hand Sign Recognition," Proceedings of the 1996 IEEE Computer Society Conference on Computer Vision and Pattern Recognition, pp. 88-93 (1996). However, parts of the hand such as intermediate finger joints and the center of the palms do not show up in capacitive proximity images at all if the hand is not flattened on the surface. Without these intermediate linkages between fingertips and palms the overall hand structure can only be guessed at, making hand contact identification

very difficult. Hence the optical flow and contour tracking techniques which have been applied to free-space hand sign language recognition as in F. Quek, "Unencumbered Gestural Interaction," IEEE Multimedia, vol. 3, pp. 36-47 (1996), do not address the special challenges of proximity image tracking.

[0022] Synaptics Corp. has successfully fabricated their electrode array on flexible mylar film rather than stiff circuit board. This is suitable for conforming to the contours of special products, but does not provide significant finger cushioning for large surfaces. Even if a cushion was placed under the film, the lack of stretchability in the film, leads, and electrodes would limit the compliance afforded by the compressible material. Boie et al suggests that placing compressible insulators on top of the electrode array cushions finger impact. However, an insulator more than about one millimeter thick would seriously attenuate the measured finger-electrode capacitances. Thus there exists a need in the art for a method to transfer finger capacitance influences through an arbitrarily thick cushion.

SUMMARY OF THE INVENTION

[0023] It is a primary object of the present invention to provide a system and method for integrating different types of manual input such as typing, multiple degree-of-freedom manipulation, and handwriting on a multi-touch surface.

[0024] It is also an object of the present invention to provide a system and method for distinguishing different types of manual input such as typing, multiple degree-of-freedom manipulation, and handwriting on a multi-touch surface, via different hand configurations which are easy for the user to learn and easy for the system to recognize.

[0025] It is a further object of the present invention to provide an improved capacitance-transducing apparatus that is cheaply implemented near each electrode so that two-dimensional sensor arrays of arbitrary size and resolution can be built without degradation in signal to noise.

[0026] It is a further object of the present invention to provide an electronic system which minimizes the number of sensing electrodes necessary to obtain proximity images with such resolution that a variety of hand configurations can be distinguished.

[0027] Yet another object of the present invention is to provide a multi-touch surface apparatus which is compliant and contoured to be comfortable and ergonomic under extended use.

[0028] Yet another object of the present invention is to provide tactile key or hand position feedback without impeding hand resting on the surface or smooth, accurate sliding across the surface.

[0029] It is a further object of the present invention to provide an electronic system which can provide images of flesh proximity to an array of sensors with such resolution that a variety of hand configurations can be distinguished.

[0030] It is another object of the present invention to provide an improved method for invoking cursor motion continuation only when the user wants it by not invoking it when significant deceleration is detected.

[0031] Another object of the present invention is to identify different hand parts as they contact the surface so that a variety of hand configurations can be recognized and used to distinguish different kinds of input activity.

[0032] Yet another object of the present invention is to reliably extract rotation and scaling as well as translation degrees of freedom from the motion of two or more hand contacts to aid in navigation and manipulation of two-dimensional electronic documents.

[0033] It is a further object of the present invention to reliably extract tilt and roll degrees of freedom from hand pressure differences to aid in navigation and manipulation of three-dimensional environments.

[0034] Additional objects and advantages of the invention will be set forth in part in the description which follows, and in part will be obvious from the description, or may be learned by practice of the invention. The objects and advantages of the invention will be realized and attained by means of the elements and combinations particularly pointed out in the appended claims.

[0035] To achieve the objects and in accordance with the purpose of the invention, as embodied and broadly described herein, the invention comprises a sensing device that is sensitive to changes in self-capacitance brought about by changes in proximity of a touch device to the sensing device, the sensing device comprising: two electrical switching means connected together in series having a common node, an input node, and an output node; a dielectric-covered sensing electrode connected to the common node between the two switching means; a power supply providing an approximately constant voltage connected to the input node of the series-connected switching means; an integrating capacitor to accumulate charge transferred during multiple consecutive switchings of the series connected switching means; another switching means connected in parallel across the integrating capacitor to deplete its residual charge; and a voltage-to-voltage translation device connected to the output node of the series-connected switching means which produces a voltage representing the magnitude of the self-capacitance of the sensing device. Alternatively, the sensing device comprises: two electrical switching means connected together in series having a common node, an input node, and an output node; a dielectric-covered sensing electrode connected to the common node between the two switching means; a power supply providing an approximately constant voltage connected to the input node of the series-connected switching means; and an integrating current-to-voltage translation device connected to the output node of the series connected switching means, the current-to-voltage translation device producing a voltage representing the magnitude of the self-capacitance of the sensing device.

[0036] To further achieve the objects, the present invention comprises a multi-touch surface apparatus for detecting a spatial arrangement of multiple touch devices on or near the surface of the multi-touch apparatus, comprising: one of a rigid or flexible surface; a plurality of two-dimensional arrays of one of the sensing devices (recited in the previous paragraph) arranged on the surface in groups wherein the sensing devices within a group have their output nodes connected together and share the same integrating capacitor, charge depletion switch, and voltage-to-voltage translation circuitry; control circuitry for enabling a single sensor device from each two-dimensional array; means for selecting the sensor voltage data from each two-dimensional array; voltage measurement circuitry to convert sensor voltage data to a digital code; and circuitry for communicating the digital code to another electronic device. The sensor

voltage data selecting means comprises one of a multiplexing circuitry and a plurality of voltage measurement circuits.

[0037] To still further achieve the objects, the present invention comprises a multi-touch surface apparatus for sensing diverse configurations and activities of touch devices and generating integrated manual input to one of an electronic or electro-mechanical device, the apparatus comprising: an array of one of the proximity sensing devices described above; a dielectric cover having symbols printed thereon that represent action-to-be-taken when engaged by the touch devices; scanning means for forming digital proximity images from the array of sensing devices; calibrating means for removing background offsets from the proximity images; recognition means for interpreting the configurations and activities of the touch devices that make up the proximity images; processing means for generating input signals in response to particular touch device configurations and motions; and communication means for sending the input signals to the electronic or electromechanical device.

[0038] To even further achieve the objects, the present invention comprises a multi-touch surface apparatus for sensing diverse configurations and activities of fingers and palms of one or more hands near the surface and generating integrated manual input to one of an electronic or electromechanical device, the apparatus comprising: an array of proximity sensing means embedded in the surface; scanning means for forming digital proximity images from the proximities measured by the sensing means; image segmentation means for collecting into groups those proximity image pixels intensified by contact of the same distinguishable part of a hand; contact tracking means for parameterizing hand contact features and trajectories as the contacts move across successive proximity images, contact identification means for determining which hand and which part of the hand is causing each surface contact; synchronization detection means for identifying subsets of identified contacts which touchdown or liftoff the surface at approximately the same time, and for generating command signals in response to synchronous taps of multiple fingers on the surface; typing recognition means for generating intended key symbols from asynchronous finger taps; motion component extraction means for compressing multiple degrees of freedom of multiple fingers into degrees of freedom common in two and three dimensional graphical manipulation; chord motion recognition means for generating one of

command and cursor manipulation signals in response to motion in one or more extracted degrees of freedom by a selected combination of fingers; pen grip detection means for recognizing contact arrangements which resemble the configuration of the hand when gripping a pen, generating inking signals from motions of the inner fingers, and generating cursor manipulation signals from motions of the palms while the inner fingers are lifted; and communication means for sending the sensed configurations and activities of finger and palms to one of the electronic and electromechanical device.

[0039] To further achieve the objects, the present invention comprises a method for tracking and identifying hand contacts in a sequence of proximity images in order to support interpretation of hand configurations and activities related to typing, multiple degree-of-freedom manipulation via chords, and handwriting, the method comprising the steps of: segmenting each proximity image into groups of electrodes which indicate significant proximity, each group representing proximity of a distinguishable hand part or other touch device; extracting total proximity, position, shape, size, and orientation parameters from each group of electrodes; tracking group paths through successive proximity images including detection of path endpoints at contact touchdown and liftoff; computing velocity and filtered position vectors along each path; assigning a hand and finger identity to each contact path by incorporating relative path positions and velocities, individual contact features, and previous estimates of hand and finger positions; and maintaining estimates of hand and finger positions from trajectories of paths currently assigned to the fingers, wherein the estimates provide high level feedback to bias segmentations and identifications in future images.

[0040] To still further achieve the objects, the present invention comprises a method for integrally extracting multiple degrees of freedom of hand motion from sliding motions of two or more fingers of a hand across a multi-touch surface, one of the fingers preferably being the opposable thumb, the method comprising the steps of: tracking across successive scans of the proximity sensor array the trajectories of individual hand parts on the surface; finding an innermost and an outermost finger contact from contacts identified as fingers on the given hand; computing a scaling velocity component from a change in a distance between the innermost and outermost finger contacts; computing a rotational velocity component from a change in a vector

angle between the innermost and outermost finger contacts; computing a translation weighting for each contacting finger; computing translational velocity components in two dimensions from a translation weighted average of the finger velocities tangential to surface; suppressively filtering components whose speeds are consistently lower than the fastest components; transmitting the filtered velocity components as control signals to an electronic or electromechanical device.

[0041] To even further achieve the objects, the present invention comprises a manual input integration method for supporting diverse hand input activities such as resting the hands, typing, multiple degree-of-freedom manipulation, command gesturing and handwriting on a multi-touch surface, the method enabling users to instantaneously switch between the input activities by placing their hands in different configurations comprising distinguishable combinations of relative hand contact timing, proximity, shape, size, position, motion and/or identity across a succession of surface proximity images, the method comprising the steps of: tracking each touching hand part across successive proximity images; measuring the times when each hand part touches down and lifts off the surface; detecting when hand parts touch down or lift off simultaneously; producing discrete key symbols when the user asynchronously taps, holds, or slides a finger on key regions defined on the surface; producing discrete mouse button click commands, key commands, or no signals when the user synchronously taps two or more fingers from the same hand on the surface; producing gesture commands or multiple degree-of-freedom manipulation signals when the user slides two or more fingers across the surface; and sending the produced symbols, commands and manipulation signals as input to an electronic or an electro-mechanical device.

[0042] To still even further achieve the objects, the present invention comprises a method for choosing what kinds of input signals will be generated and sent to an electronic or electromechanical device in response to tapping or sliding of fingers on a multi-touch surface, the method comprising the following steps: identifying each contact on the surface as either a thumb, fingertip or palm; measuring the times when each hand part touches down and lifts off the surface; forming a set of those fingers which touch down from the all finger floating state before any one of the fingers lifts back off the surface; choosing the kinds of input signals to be

generated by further distinctive motion of the fingers from the combination of finger identities in the set; generating input signals of this kind when further distinctive motions of the fingers occur; forming a subset any two or more fingers which touch down synchronously after at least one finger has lifted back off the surface; choosing a new kinds of input signals to be generated by further distinctive motion of the fingers from the combination of finger identities in the subset; generating input signals of this new kind when further distinctive motions of the fingers occur; and continuing to form new subsets, choose and generate new kinds of input signals in response to liftoff and synchronous touchdowns until all fingers lift off the surface.

[0043] To further achieve the objects, the present invention comprises a method for continuing generation of cursor movement or scrolling signals from a tangential motion of a touch device over a touch-sensitive input device surface after touch device liftoff from the surface if the touch device operator indicates that cursor movement continuation is desired by accelerating or failing to decelerate the tangential motion of the touch device before the touch device is lifted, the method comprising the following steps: measuring, storing and transmitting to a computing device two or more representative tangential velocities during touch device manipulation; computing and storing a liftoff velocity from touch device positions immediately prior to the touch device liftoff; comparing the liftoff velocity with the representative tangential velocities, and entering a mode for continuously moving the cursor if a tangential liftoff direction approximately equals the representative tangential directions and a tangential liftoff speed is greater than a predetermined fractional multiple of representative tangential speeds; continuously transmitting cursor movement signals after liftoff to a computing device such that the cursor movement velocity corresponds to one of the representative tangential velocities; and ceasing transmission of the cursor movement signals when the touch device engages the surface again, if comparing means detects significant deceleration before liftoff, or if the computing device replies that the cursor can move no farther or a window can scroll no farther.

[0044] It is to be understood that both the foregoing general description and the following detailed description are exemplary and explanatory only and are not restrictive of the invention as claimed.

BRIEF DESCRIPTION OF THE DRAWINGS

[0045] The accompanying drawings, which are incorporated in and constitute a part of this specification, illustrate several embodiments of the invention and together with the description, serve to explain the principles of the invention. In the drawings:

[0046] FIG. 1 is a block diagram of the integrated manual input apparatus;

[0047] FIG. 2 is a schematic drawing of the proximity sensor with voltage amplifier;

[0048] FIG. 3 is a schematic drawing of the proximity sensor with integrating current amplifier;

[0049] FIG. 4 is a schematic drawing of the proximity sensor implemented with field effect transistors;

[0050] FIG. 5 is a schematic drawing of the proximity sensor as used to implement 2D arrays of proximity sensors;

[0051] FIG. 6 is a block diagram showing a typical architecture for a 2D array of proximity sensors where all sensors share the same amplifier;

[0052] FIG. 7 is a block diagram of circuitry used to convert proximity sensor output to a digital code;

[0053] FIG. 8 is a block diagram showing a typical architecture for a 2D array of proximity sensors where sensors within a row share the same amplifier;

[0054] FIG. 9 is a schematic of a circuit useful for enabling the output gates of all proximity sensors within a group (arranged in columns);

[0055] FIG. 10 is a side view of a 2D proximity sensor array that is sensitive to the pressure exerted by non-conducting touch objects;

[0056] FIG. 11 is a, side view of a 2D proximity sensor array that provides a compliant surface without loss of spatial sensitivity;

[0057] FIG. 12 is a side view of a 2D proximity sensor array that is sensitive to both the proximity of conducting touch objects and to the pressure exerted by non-conducting touch objects;

[0058] FIG. 13 is an example proximity image of a hand flattened onto the surface with fingers outstretched;

[0059] FIG. 14 is an example proximity image of a hand partially closed with fingertips normal to surface;

[0060] FIG. 15 is an example proximity image of a hand in the pen grip configuration with thumb and index fingers pinched;

[0061] FIG. 16 is a data flow diagram of the hand tracking and contact identification system;

[0062] FIG. 17 is a flow chart of hand position estimation;

[0063] FIG. 18 is a data flow diagram of proximity image segmentation;

[0064] FIG. 19 is a diagram of the boundary search pattern during construction of an electrode group;

[0065] FIG. 20A is a diagram of the segmentation strictness regions with both hands in their neutral, default position on surface;

[0066] FIG. 20B is a diagram of the segmentation strictness regions when the hands are in asymmetric positions on surface;

[0067] FIG. 20C is a diagram of the segmentation strictness regions when the right hand crosses to the left half of the surface and the left hand is off the surface;

[0068] FIG. 21 is a flow chart of segmentation edge testing;

- [0069] FIG. 22 is a flow chart of persistent path tracking;
- [0070] FIG. 23 is a flow chart of the hand part identification algorithm;
- [0071] FIG. 24 is a Voronoi cell diagram constructed around hand part attractor points;
- [0072] FIG. 25A is a plot of orientation weighting factor for right thumb, right inner palm, and left outer palm versus contact orientation;
- [0073] FIG. 25B is a plot of thumb size factor versus contact size;
- [0074] FIG. 25C is a plot of palm size factor versus ratio of total contact proximity to contact eccentricity;
- [0075] FIG. 25D is a plot of palm separation factor versus distance between a contact and its nearest neighbor contact;
- [0076] FIG. 26 is a flow chart of the thumb presence verification algorithm;
- [0077] FIG. 27 is a flow chart of an alternative hand part identification algorithm;
- [0078] FIG. 28 is a flow chart of the pen grip detection process;
- [0079] FIG. 29 is a flow chart of the hand identification algorithm;
- [0080] FIGS. 30A-C show three different hand partition hypotheses for a fixed arrangement of surface contacts;
- [0081] FIG. 31A is a plot of the hand clutching direction factor versus horizontal hand velocity;
- [0082] FIG. 31B is a plot of the handedness factor versus vertical position of outermost finger relative to next outermost;
- [0083] FIG. 31C is a plot of the palm cohesion factor versus maximum horizontal separation between palm contacts within a hand;

- [0084] FIG. 32 is a plot of the inner finger angle factor versus the angle between the innermost and next innermost finger contacts;
- [0085] FIG. 33 is a plot of the inter-hand separation factor versus the estimated distance between the right thumb and left thumb;
- [0086] FIG. 34 is a flow chart of hand motion component extraction;
- [0087] FIG. 35 is a diagram of typical finger trajectories when hand is contracting;
- [0088] FIG. 36 is a flow chart of radial and angular hand velocity extraction;
- [0089] FIG. 37 is a flow chart showing extraction of translational hand velocity components;
- [0090] FIG. 38 is a flow chart of differential hand pressure extraction;
- [0091] FIG. 39A is a flow chart of the finger synchronization detection loop;
- [0092] FIG. 39B is a flow chart of chord tap detection;
- [0093] FIG. 40A is a flow chart of the chord motion recognition loop;
- [0094] FIG. 40B is a flow chart of chord motion event generation;
- [0095] FIG. 41 is a flow chart of key layout morphing;
- [0096] FIG. 42 is a flow chart of the keypress detection loop;
- [0097] FIG. 43A is a flow chart of the keypress acceptance and transmission loop; and
- [0098] FIG. 43B is a flow chart of typematic emulation.

DESCRIPTION OF THE PREFERRED EMBODIMENTS

[0099] Reference will now be made in detail to the present preferred embodiments of the invention, examples of which are illustrated in the accompanying drawings. Wherever possible

the same reference numbers will be used throughout the drawings to refer to the same or like parts.

[0100] FIG. 1 is a system block diagram of the entire, integrated manual input apparatus. Sensor embedded in the multi-touch surface 2 detect proximity of entire flattened hands 4, fingertips thumbs, palms, and other conductive touch devices to the surface 2. In a preferred embodiment, the surface is large enough to comfortably accommodate both hands 4 and is arched to reduce forearm pronation.

[0101] In alternative embodiments the multi-touch surface 2 may be large enough to accommodate motion of one hand, but may be flexible so it can be fitted to an armrest or clothing.

[0102] Electronic scanning hardware 6 controls and reads from each proximity sensor of a sensor array. A calibration module 8 constructs a raw proximity image from a complete scan of the sensor array and subtracts off any background sensor offsets. The background sensor offsets can simply be a proximity image taken when nothing is touching the surface.

[0103] The offset-corrected proximity image is then passed on to the contact tracking and identification module 10, which segments the image into distinguishable hand-surface contacts, tracks and identifies them as they move through successive images.

[0104] The paths of identified contacts are passed on to a typing recognizer module 12, finger synchronization detection module 14, motion component extraction module 16, and pen grip detection module 17, which contain software algorithms to distinguish hand configurations and respond to detected hand motions.

[0105] The typing recognizer module 12 responds to quick presses and releases of fingers which are largely asynchronous with respect to the activity of other fingers on the same hand. It attempts to find the key region nearest to the location of each finger tap and forwards the key symbols or commands associated with the nearest key region to the communication interface module 20.

[0106] The finger synchronization detector 14 checks the finger activity within a hand for simultaneous presses or releases of a subset of fingers. When such simultaneous activity is detected it signals the typing recognizer to ignore or cancel keystroke processing for fingers contained in the synchronous subset. It also passes on the combination of finger identities in the synchronous subset to the chord motion recognizer 18.

[0107] The motion component extraction module 16 computes multiple degrees of freedom of control from individual finger motions during easily performable hand manipulations on the surface 2, such as hand translations, hand rotation about the wrist, hand scaling by grasping with the fingers, and differential hand tilting.

[0108] The chord motion recognizer produces chord tap or motion events dependent upon both the synchronized finger subset identified by the synchronization detector 14 and on the direction and speed of motion extracted in 16. These events are then posted to the host communication interface 20.

[0109] The pen grip detection module 17 checks for specific arrangements of identified hand contacts which indicate the hand is configured as if gripping a pen. If such an arrangement is, detected, it forwards the movements of the gripping fingers as inking events to the host communication interface 20. These inking events can either lay digital ink on the host computer display for drawing or signature capture purposes, or they can be further interpreted by handwriting recognition software which is well known in the art. The detailed steps within each of the above modules will be further described later.

[0110] The host communication interface keeps events from both the typing recognizer 12 and chord motion recognizer 18 in a single temporally ordered queue and dispatches them to the host computer system 22. The method of communication between the interface 20 and host computer system 22 can vary widely depending on the function and processing power of the host computer. In a preferred embodiment, the communication would take place over computer cables via industry standard protocols such as Apple Desktop Bus, PS/2 keyboard and mouse protocol for PCs, or Universal Serial Bus (USB). In alternative embodiments the software processing of modules 10-18 would be performed within the host computer 22. The multi-touch

surface apparatus would only contain enough hardware to scan the proximity sensor array 6, form proximity images 8, and compress and send them to the host computer over a wireless network. The host communication interface 20 would then play the role of device driver on the host computer, conveying results of the proximity image recognition process as input to other applications residing on the host computer system 22.

[0111] In a preferred embodiment the host computer system outputs to a visual display device 24 so that the hands and fingers 4 can manipulate graphical objects on the display screen. However, in alternative embodiments the host computer might output to an audio display or control a machine such as a robot.

[0112] The term “proximity” will only be used in reference to the distance or pressure between a touch device such as a finger and the surface 2, not in reference to the distance between adjacent fingers. “Horizontal” and “vertical” refer to x and y directional axes within the surface plane. Proximity measurements are then interpreted as pressure in a z axis normal to the surface. The direction “inner” means toward the thumb of a given hand, and the direction “outer” means towards the pinky finger of a given hand. For the purposes of this description, the thumb is considered a finger unless otherwise noted, but it does not count as a fingertip. “Contact” is used as a general term for a hand part when it touches the surface and appears in the current proximity image, and for the group and path data structures which represent it.

[0113] FIG. 2 is a schematic diagram of a device that outputs a voltage 58 dependent on the proximity of a touch device 38 to a conductive sense electrode 33. The proximity sensing device includes two electrical switching means 30 and 31 connected together in series having a common node 48, an input node 46, and an output node 45. A thin dielectric material 32 covers the sensing electrode 33 that is electrically connected to the common node 48. A power supply 34 providing an approximately constant voltage is connected between reference ground and the input node 46. The two electrical switches 30 and 31 gate the flow of charge from the power supply 34 to an integrating capacitor 37. The voltage across the integrating capacitor 37 is translated to another voltage 58 by a high-impedance voltage amplifier 35. The plates of the integrating capacitor 37 can be discharged by closing electrical switch 36 until the voltage across the integrating capacitor 37 is near zero. The electrical switches 30 and 31 are opened and

closed in sequence but are never closed at the same time, although they may be opened at the same time as shown in FIG. 2. Electrical switch 30 is referred to as the input switch; electrical switch 31 is referred to as the output switch; and, electrical switch 36 is referred to as the shorting switch.

[0114] The proximity sensing device shown in FIG. 2 is operated by closing and opening the electrical switches 30, 31, and 36 in a particular sequence after which the voltage output from the amplifier 58, which is dependent on the proximity of a touch device 38, is recorded. Sensor operation begins with all switches in the open state as shown in FIG. 2. The shorting switch 36 is then closed for a sufficiently long time to reduce the charge residing on the integrating capacitor 37 to a low level. The shorting switch 37 is then opened. The input switch 30 is then closed thus allowing charge to flow between the power supply and the common node 48 until the voltage across the input switch 30 becomes zero. Charge Q will accumulate on the sensing electrode 33 according to

$$Q = V(e * A) / D \quad (1)$$

where V is the voltage of the power supply 34, e is the permittivity of the dielectric sensing electrode cover 32 and the air gap between the cover and the touch device 38, D is the thickness of this dielectric region, and A is the overlap area of the touch device 38 and the sensing electrode 33. Therefore the amount of charge accumulating on the sensing electrode 33 will depend, among other things, on the area of overlap of the touch device 38 and the sensing electrode 33 and the distance between the touch device 38 and the sensing electrode 33. The input switch 30 is opened after the voltage across it has become zero, or nearly so. Soon after input switch 30 is opened the output switch 31 is closed until the voltage across it is nearly zero. Closing the output switch 31 allows charge to flow between the sensing electrode 33 and the integrating capacitor 37 resulting in a voltage change across the integrating capacitor 37 according to:

$$\Delta V = (V - V_c) / (1 + C * D / e * A) \quad (2)$$

where V_c is the voltage across the integrating capacitor 37 before the output switch 31 was closed, C is the capacitance of the integrating capacitor 37, and A and D are equal to their values when input switch 30 was closed as shown in Equation 1. Multiple switchings of the input 30 and output 31 switches as described above produce a voltage on the integrating capacitor 37 that reflects the proximity of a touch device 38 to the sensing electrode 33.

[0115] FIG. 3A is a schematic diagram of the proximity sensor in which the shorting transistor 36 and the voltage-to-voltage translation device 35 are replaced by a resistor 40 and a current-to-voltage translation device 41, respectively. The integrating function of capacitor 37 shown in FIG. 2 is, in this variation of the proximity sensor, carried out by the capacitor 39 shown in FIG. 3A. Those skilled in the art will see that this variation of the proximity sensor produces a more linear output 58 from multiple switchings of the input and output switches, depending on the relative value of the resistor 40. Alternatively, the resistor 40 can be replaced by a shorting switch 69 (cf. FIG. 3B) to improve linearity. Although, the circuits shown in FIG. 3 provide a more linear output than the circuit shown in FIG. 2 the circuits of FIG. 3 generally require dual power supplies while the circuit of FIG. 2 requires only one.

[0116] The electrical switches shown in, FIG. 2 can be implemented with various transistor technologies: discrete, integrated, thin film, thick film, polymer, optical, etc. One such implementation is shown in FIG. 4A where field effect transistors (FETs) are used as the input 30, output 31, and shorting 36 switches. The FETs are switched on and off by voltages applied to their gate terminals (43, 44, and 55). For the purpose of this description we will assume the FET is switched on when its gate voltage is logic 1 and switched off when its gate voltage is logic 0. A controller 42 is used to apply gate voltages as a function of time as shown in FIG. 4B. In this example, a sequence of three pairs of pulses (43 and 44) are applied to the input and output transistor gates. Each pair of pulses 43 and 44 produces a voltage change across the integrating capacitor 37 as shown in Equation 2. The number of pulse pairs applied to input 43 and output 44 gates depends on the desired voltage across integrating capacitor 37. In typical applications the number is between one and several hundred pulse-pairs.

[0117] FIG. 5 shows the proximity sensor circuitry appropriate for use in a system comprising an array of proximity sensors 47 as in a multi-touch surface system. The proximity

sensor 47 consists of the input transistor 30, the output transistor 31, the sensing electrode 33, the dielectric cover 32 for the sensing electrode 33, and conductive traces 43, 44, 45, and 46. The conductive traces are arranged so as to allow the proximity sensors 47 comprising a 2D array to be closely packed and to share the same conductive traces, thus reducing the number of wires needed in a system. FIG. 6 shows an example of such a system where the input nodes 46 of all proximity sensors are connected together and connected to a power supply 34. The output nodes 45 of all proximity sensors are connected together and connected to a single integrating capacitor 37, a single shorting transistor 36, and a single voltage-to-voltage amplifier 35. In this implementation, a single proximity sensor 47 is enabled at a time by applying a logic 1 signal first to its input gate 43 and then to its output gate 44. This gating of a single proximity sensor 47 one at a time is done by input gate controller 50 and output gate controller 51. For example, to enable the proximity sensor 47 in the lower right corner the input gate controller 50 would output a logic one pulse on conductive trace 43a. This is followed by a logic one pulse on conductive trace 44h produced by output gate controller 51. Repetition of this pulse as shown in FIG. 4B would cause charge to build up on integrating capacitor 37 and a corresponding voltage to appear at the output of the amplifier 58. The entire array of proximity sensors 47 is thus scanned by enabling a single sensor at a time and recording its output.

[0118] FIG. 7A is a schematic of typical circuitry useful for converting the proximity sensor output 58 to a digital code appropriate for processing by computer. The proximity sensor output 58 is typically non-zero even when there is no touch device (*e.g.*, ref. no. 38 in FIG. 2) nearby. This non-zero signal is due to parasitic or stray capacitance present at the common node 48 of the proximity sensor and is of relatively constant value. It is desirable to remove this non-zero background signal before converting the sensor output 58 to a digital code. This is done by using a differential amplifier 64 to subtract a stored record of the background signal 68 from the sensor output 58. The resulting difference signal 65 is then converted to a digital code by an ADC (analog to digital converter) 60 producing a K-bit code 66. The stored background signal is first recorded by sampling the array of proximity sensors 47 (FIG. 6) with no touch devices nearby and storing a digital code specific for each proximity sensor 47 in a memory device 63. The particular code corresponding to the background signal of each proximity sensor is selected by

an M-bit address input 70 to the memory device 63 and applied 69 to a DAC (digital to analog converter) 61.

[0119] The 2D array of proximity sensors 47 shown in FIG. 6 can be connected in groups so as to improve the rate at which the entire array is scanned. This is illustrated in FIG. 8 where the groups are arranged as columns of proximity sensors. In this approach, the input nodes of the proximity sensors are connected together and connected to a power supply 34, as in FIG. 6. The output gates 44 are also connected in the same way. However, the input gates 43 are now all connected together and the output nodes 45 are connected to only those proximity sensors 47 within a row and to a dedicated voltage amplifier 35. With this connection method, all of the proximity sensors in a column are enabled at a time, thus reducing the time to scan the array by a factor N, where N is the number of proximity sensors in a group. The outputs 58a-h could connect to dedicated converter circuitry as shown in FIG. 7A or alternatively each output 58a-h could be converted one at a time using the circuitry shown in FIG. 7B. In this figure, the output signals from each group 58a-h are selected one at a time by multiplexer 62 and applied to the positive input of the differential amplifier 64. With this later approach, it is assumed that the ADC 60 conversion time is much faster than the sensor enable time, thus providing the suggested speed up in sensor array scanning.

[0120] FIG. 9 shows a typical circuit useful for the control of the proximity sensor's output gate 44. It consists of three input signals 75, 76, 78 and two output signals 44, 77. The output gate signal 44 is logic 1 when both inputs to AND gate 79 are logic 1. The AND input signal 77 becomes logic 1 if input signal 76 is logic 1 when input signal 78 transitions from logic 0 to logic 1, otherwise it remains logic 0. A linear array of these circuits 81 can be connected end-to-end to enable the output gates of a single group of proximity sensors at a time as shown in FIG. 8.

[0121] FIG. 10 shows a cover for the multi-touch surface 89 that permits the system to be sensitive to pressure exerted by non-conducting touch objects (*e.g.*, gloved fingers) contacting the multi-touch surface. This cover comprises a deformable dielectric touch layer 85, a deformable conducting layer 86, and a compliant dielectric layer 87. The touch surface 85 would have a symbol set printed on it appropriate for a specific application, and this surface could be removed and replaced with another one having a different symbol set. The conducting

layer 86 is electrically connected 88 to the reference ground of the proximity sensor's power supply 34. When a touch object presses on the top surface 85 it causes the conducting surface 86 under the touch device to move closer to the sensing electrode 33 of the proximity sensor. This results in a change in the amount of charge stored on the sensing electrode 33 and thus the presence of the touch object can be detected. The amount of charge stored will depend on the pressure exerted by the touch object. More pressure results in more charge stored as indicated in Equation 1.

[0122] To obtain a softer touch surface on the multi-touch device a thicker and more, compliant dielectric cover could be used. However, as the dielectric thickness increases the effect of the touch device on the sensing electrodes 33 spreads out thus lowering spatial resolution. A compliant anisotropically-conducting material can be used to counter this negative effect while also providing a soft touch surface. FIG. 11 shows a cover in which a compliant anisotropically-conducting material 90 is set between a thin dielectric cover 85 and the sensing electrodes 33. If the conductivity of the compliant material 90 is oriented mostly in the vertical direction, the image formed by a touch device on the surface 85 will be translated without significant spreading to the sensing electrodes 33, thus preserving spatial resolution while providing a compliant touch surface.

[0123] FIG. 12 shows a cross section of a multi-touch surface that senses both the proximity and pressure of a touch device. The touch layer 85 is a thin dielectric that separates touch devices from the sensing electrodes 33. Proximity sensing is relative to this surface. The electrodes 33 and associated switches and conductors are fabricated on a compliant material 89 which is attached to a rigid metal base 92. The metal base 92 is electrically connected 88 to the reference ground of the proximity sensor's power supply 34. When a touch device presses on the touch surface 85 it causes the sensing electrodes 33 directly below to move closer to the rigid metal base 92. The distance moved depends on the pressure applied and thus the pressure exerted by a touch device can be detected as described before.

[0124] To illustrate typical properties of hand contacts as they appear in proximity images, FIGS. 13-15 contain sample images captured by a prototype array of parallelogram-shaped electrodes. Shading of each electrode darkens to indicate heightened proximity signals as flesh

gets closer to the surface, compresses against the surface due to hand pressure, and overlaps the parallelogram more completely. Note that the resolution of these images is in no way intended to limit the scope of the invention, since certain applications such as handwriting recognition will clearly require finer electrode arrays than indicated by the electrode size in these sample images. In the discussion that follows, the proximity data measured at one electrode during a particular scan cycle constitutes one “pixel” of the proximity image captured in that scan cycle.

[0125] FIG. 13 shows a right hand flattened against the surface with fingers outstretched. At the far left is the oblong thumb 201 which tends to point off at about 120-degrees. The columnar blobs arranged in an arc across the top of the image are the index finger 202, middle finger 203, ring finger 204 and pinky finger 205. Flesh from the proximal finger joint, or proximal phalanges 209, will appear below each fingertip if the fingers are fully extended. The inner 207 and outer 206 palm heels cause the pair of very large contacts across the bottom of the image. Forepalm calluses 213 are visible at the center of the hand if the palm is fully flattened. This image shows that all the hand contacts are roughly oval-shaped, but they differ in pressure, size, orientation, eccentricity and spacing relative to one another. This image includes all of the hand parts which can touch the surface from the bottom of one hand but in many instances only a few of these parts will be touching the surface, and the fingertips may roam widely in relation to the palms as fingers are flexed and extended.

[0126] FIG. 14 shows another extreme in which the hand is partially closed. The thumb 201 is adducted toward the fingertips 202-208 and the fingers are flexed so the fingertips come down normal instead of tangential to the surface. The height and intensity of fingertip contacts is lessened somewhat because the boney tip rather than fleshy pulp pad is actually touching the surface, but fingertip width remains the same. Adjacent fingertips 202-205 and thumb 201 are so close together as to be distinguishable only by slight proximity valleys 210 between them. The proximal phalange finger joints are suspended well above the surface and do not appear in the image, nor do the forepalm calluses. The palm heels 206, 207 are somewhat shorter since only the rear of the palm can touch the surface when fingers are flexed, but the separation between them is unchanged. Notice that the proximity images are uncluttered by background objects.

Unlike optical images, only conductive objects within a few millimeters of the surface show up at all.

[0127] FIG. 15 is a proximity image of a right hand in a pen grip configuration. The thumb 201 and index fingertip 202 are pinched together as if they were holding a pen but in this case they are touching the surface instead. Actually the thumb and index finger appear the same here as in FIG. 14. However, the middle 203, ring 204, and pinky 205 fingers are curled under as if making a fist, so the knuckles from the top of the fingers actually touch the surface instead of the finger tips. The curling under of the knuckles actually places them behind the pinched thumb 201 and index fingertip 202 very close to the palm heels 206, 207. The knuckles also appear larger than the curled fingertips of FIG. 14 but the same size as the flattened fingertips in FIG. 13. These differences in size and arrangement will be measured by the pen grip detector 17 to distinguish this pen grip configuration from the closed and flattened hand configurations.

[0128] FIG. 16 represents the data flow within the contact tracking and identification module 10. The image segmentation process 241 takes the most recently scanned proximity image data 240 and segments it into groups of electrodes 242 corresponding to the distinguishable hand parts of FIG. 13. The filtering and segmentation rules applied in particular regions of the image are partially determined by feedback of the estimated hand offset data 252. The image segmentation process 241 outputs a set of electrode group data structures 242 which are parameterized by fitting an ellipse to the positions and proximity measurements of the electrodes within each group.

[0129] The path tracking process 245 matches up the parameterized electrode groups 242 with the predicted continuations of contact path data structures 243 extracted from previous images. Such path tracking ensures continuity of contact representation across proximity images. This makes it possible to measure the velocity of individual hand contacts and determine when a hand part lifts off the surface, disappearing from future images. The path tracking process 245 updates the path positions, velocities, and contact geometry features from the parameters of the current groups 242 and passes them on to the contact identification processes 247 and 248. For notational purposes, groups and unidentified paths will be referred to by data structure names of the form G_i and P_i respectively, where the indices i are arbitrary

except for the null group G0 and null path P0. Particular group and path parameters will be denoted by subscripts to these structure names and image scan cycles will be denoted by bracketed indices, so that, for example, $P2_x[n]$ represents the horizontal position of path 2 in the current proximity image, and $P2_x[n-1]$ represents the position in the previous proximity image. The contact identification system is hierarchically split into a hand identification process 247 and within-hand finger and palm identification process 248. Given a hand identification for each contact, the finger and palm identification process 248 utilizes combinatorial optimization and fuzzy pattern recognition techniques to identify the part of the hand causing each surface contact. Feedback of the estimated hand offset helps identify hand contacts when so few contacts appear in the image that the overall hand structure is not apparent.

[0130] The hand identification process 247 utilizes a separate combinatorial optimization algorithm to find the assignment of left or right hand identity to surface contacts which results in the most biomechanically consistent within-hand identifications. It also receives feedback of the estimated hand and finger offsets 252, primarily for the purpose of temporarily storing the last measured hand position after fingers in a hand lift off the surface. Then if the fingers soon touch back down in the same region they will more likely receive their previous hand identifications.

[0131] The output of the identification processes 247 and 248 is the set of contact paths with non-zero hand and finger indices attached. For notational purposes identified paths will be referred to as F0 for the unidentified or null finger, F1 for the thumb 201, F2 for the index finger 202, F3 for the middle finger 203, F4 for the ring finger 204, F5 for the pinky finger 205, F6 for the outer palm heel 206, F7 for the inner palm heel 207, and F8 for the forepalm calluses 208. To denote a particular hand identity this notation can be prefixed with an L for left hand or R for right hand, so that, for example, RF2 denotes the right index finger path. When referring to a particular hand as a whole, LH denotes the left hand and RH denotes the right hand. In the actual algorithms left hand identity is represented by a -1 and right hand by +1, so it is easy to reverse the handedness of measurements taken across the vertical axis of symmetry.

[0132] It is also convenient to maintain for each hand a set of bitfield data registers for which each bit represents touchdown, continued contact or liftoff of a particular finger. Bit positions

within each bit field correspond to the hand part indices above. Such registers can quickly be tested with a bit mask to determine whether a particular subset of fingers has touched down. Alternatively, they can be fed into a lookup table to find the input events associated with a particular finger chord (combination of fingers). Such finger identity bitfields are needed primarily by the synchronization detector 14 and chord motion recognizer 18.

[0133] The last process within the tracking and identification subsystem is the hand position estimator 251, which as described above provides biasing feedback to the identification and segmentation processes. The hand position estimator is intended to provide a conservative guess 252 of lateral hand position under all conditions including when the hand is floating above the surface without touching. In this case the estimate represents a best guess of where the hand will touch down again. When parts of a hand are touching the surface, the estimate combines the current position measurements of currently identified hand parts with past estimates which may have been made from more or less reliable identifications.

[0134] The simplest but inferior method of obtaining a hand position measurement would be to average the positions of all the hand's contacts regardless of identity. If hand parts 201-207 were all touching the surface as in FIG. 13 the resulting centroid would be a decent estimate, lying somewhere under the center of the palm since the fingers and palm heels typically form a ring around the center of the palm. However, consider when only one hand contact is available for the average. The estimate would assume the hand center is at the position of this lone contact, but if the contact is from the right thumb the hand center would actually be 4-8 cm to the right, or if the contact is from a palm heel the hand center is actually 4-6 cm higher, or if the lone contact is from the middle finger the hand center should actually be actually 4-6 cm lower.

[0135] FIG. 17 shows the detailed steps within the hand position estimator 251. The steps must be repeated for each hand separately. In a preferred embodiment, the process utilizes the within-hand contact identifications (250) to compute (step 254) for each contact an offset between the measured contact position $(F_{i_x}[n], F_{i_y}[n])$ and the default position of the particular finger or palm heel $(F_{i_{defx}}, F_{i_{defy}})$ with hand part identity i . The default positions preferably correspond to finger and palm positions when the hand is in a neutral posture with fingers

partially closed, as when resting on home row of a keyboard. Step 255 averages the individual contact offsets to obtain a measured hand offset, $(H_{mox}[n], H_{moy}[n])$:

$$H_{mox}[n] = \frac{\sum_{i=1}^{i=7} Fi_{mow}[n](Fi_x[n] - Fi_{defx})}{\sum_{i=1}^{i=7} Fi_{mow}[n]} \quad (3)$$

$$H_{moy}[n] = \frac{\sum_{i=1}^{i=7} Fi_{mow}[n](Fi_y[n] - Fi_{defy})}{\sum_{i=1}^{i=7} Fi_{mow}[n]} \quad (4)$$

[0136] Preferably the weighting $Fi_{mow}[n]$ of each finger and palm heel is approximately its measured total proximity, *i.e.*, $Fi_{mow}[n] = Fi_z[n]$. This ensures that lifted fingers, whose proximity is zero, have no influence on the average, and that contacts with lower than normal proximity, whose measured positions and identities are less accurate, have low influence. Furthermore, if palm heels are touching, their large total proximities will dominate the average. This is beneficial because the palm heels, being immobile relative to the hand center compared to the highly flexible fingers, supply a more reliable indication of overall hand position. When a hand is not touching the surface, *i.e.*, when all proximities are zero, the measured offsets are set to zero. This will cause the filtered hand position estimate below to decay toward the default hand position.

[0137] As long as the contact identifications are correct, this hand position measurement method eliminates the large errors caused by assuming lone contacts originate from the center of the hand. Flexing of fingers from their default positions will not perturb the measured centroid more than a couple centimeters. However, this scheme is susceptible to contact misidentification, which can cause centroid measurement errors of up to 8 cm if only one hand part is touching. Therefore, the current measured offsets are not used directly, but are averaged with previous offset estimates $(H_{eox}[n-1], H_{eoy}[n-1])$ using a simple first-order autoregressive filter, forming current offset estimates $(H_{eox}[n], H_{eoy}[n])$.