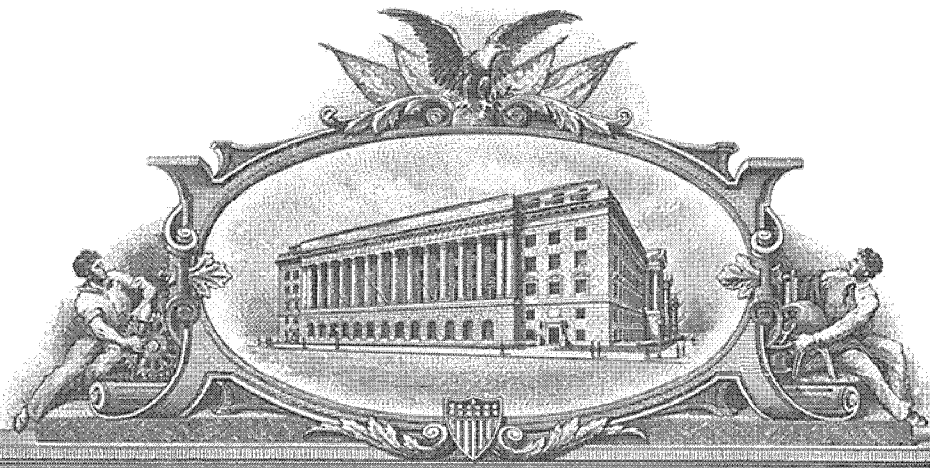

EXHIBIT A

7293088



THE UNITED STATES OF AMERICA

TO ALL TO WHOM THESE PRESENTS SHALL COME:

UNITED STATES DEPARTMENT OF COMMERCE

United States Patent and Trademark Office

April 25, 2011

THIS IS TO CERTIFY THAT ANNEXED IS A TRUE COPY FROM THE RECORDS OF THIS OFFICE OF THE FILE WRAPPER AND CONTENTS OF:

APPLICATION NUMBER: 29/328,018
FILING DATE: November 18, 2008
PATENT NUMBER: D618677
ISSUE DATE: June 29, 2010



Certified by

David J. Kappas

Under Secretary of Commerce
for Intellectual Property
and Director of the United States
Patent and Trademark Office

APLPROS0000011597

SCORE Placeholder Sheet for IFW Content

Application Number: 29328018

Document Date: 11/18/2008

The presence of this form in the IFW record indicates that the following document type was received in electronic format on the date identified above. This content is stored in the SCORE database.

- Design Drawing

Since this was an electronic submission, there is no physical artifact folder, no artifact folder is recorded in PALM, and no paper documents or physical media exist. The TIFF images in the IFW record were created from the original documents that are stored in SCORE.

To access the documents in the SCORE database, refer to instructions developed by SIRA.

At the time of document entry (noted above):

- Examiners may access SCORE content via the eDAN interface.
- Other USPTO employees can bookmark the current SCORE URL (<http://es/ScoreAccessWeb/>).
- External customers may access SCORE content via the Public and Private PAIR interfaces.

Form Revision Date: February 8, 2006

Under the Paperwork Reduction Act of 1995, no persons are required to respond to a collection of information unless it displays a valid OMB control number.

**DESIGN
PATENT APPLICATION
TRANSMITTAL**

(Only for new nonprovisional applications under 37 CFR 1.53(b))

Attorney Docket No.	2607.0590002(P4984USD1)/TGD/AKS
First Named Inventor	Bartley K. ANDRE
Title	Electronic Device
Express Mail Label No.	

ADDRESS TO:
Commissioner for Patents
P.O. Box 1450
Alexandria, VA 22313-1450

DESIGN V. UTILITY: A "design patent" protects an article's ornamental appearance (e.g., the way an article looks) (35 U.S.C. 171), while a "utility patent" protects the way an article is used and works (35 U.S.C. 101). The ornamental appearance of an article includes its shape/configuration or surface ornamentation upon the article, or both. Both a design and a utility patent may be obtained on an article if invention resides both in its ornamental appearance and its utility. For more information, see MPEP 1502.01.

APPLICATION ELEMENTS

See MPEP 1500 concerning design patent application contents.

- Fee Transmittal Form (e.g., PTO/SB/17)
- Applicant claims small entity status. See 37 CFR 1.27.
- Specification [Total Pages 4]
(preferred arrangement set forth below, MPEP 1503.01)
- Preamble
- Cross References to Related Applications
- Statement Regarding Fed sponsored R & D
- Description of the figure(s) of the drawings
- Feature description
- Claim (only one (1) claim permitted, MPEP 1503.03)
- Drawing(s) (37 CFR 1.152) [Total Sheets 8]
- Oath or Declaration [Total Pages 8]
a. Newly executed (original or copy)
b. A copy from a prior application (37 CFR 1.63(d))
(for continuation/divisional with Box 16 completed)
 DELETION OF INVENTOR(S)
 i. Signed statement attached deleting inventor(s) named in the prior application, see 37 CFR 1.63(d)(2) and 1.33(b)
- Application Data Sheet. See 37 CFR 1.76

ACCOMPANYING APPLICATION PARTS

- Assignment Papers (cover sheet & document(s))
- 37 CFR 3.73(b) Statement Power of Attorney
(when there is an assignee)
- English Translation Document (if applicable)
- Information Disclosure Statement (IDS)
PTO/SB/08 or PTO-1449
 Copies of foreign patent documents, publications, & other information
- Preliminary Amendment
- Return Receipt Postcard (MPEP 503)
(Should be specifically itemized)
- Certified Copy of Priority Document(s)
(if foreign priority is claimed)
- Request for Expedited Examination of a Design Application
(37 CFR 1.155) (NOTE: Use "Mail Stop Expedited Design")
- Other: Authorization under 37 CFR 1.136(a)(3)

16. If a CONTINUING APPLICATION, check appropriate box, and supply the requisite information below and in the first sentence of the specification following the title, or in an Application Data Sheet under 37 CFR 1.76:

Continuation Divisional Continuation-in-part (CIP) of prior application No.: 29/282,834

Prior application information: Examiner Angela J. Lee Art Unit: 2911

17. CORRESPONDENCE ADDRESS

The address associated with Customer Number: 63975 OR Correspondence address below

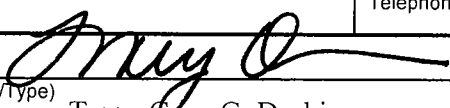
Name			
Address			
City	State	Zip Code	
Country	Telephone	Email	
Signature 	Date		November 18, 2008
Name (Print/Type) Tracy-Gene G. Durkin	Registration No. (Attorney/Agent)		32,831

This collection of information is required by 37 CFR 1.53(b). The information is required to obtain or retain a benefit by the public which is to file (and by the USPTO to process) an application. Confidentiality is governed by 35 U.S.C. 122 and 37 CFR 1.11 and 1.14. This collection is estimated to take 12 minutes to complete, including gathering, preparing, and submitting the completed application form to the USPTO. Time will vary depending upon the individual case. Any comments on the amount of time you require to complete this form and/or suggestions for reducing this burden, should be sent to the Chief Information Officer, U.S. Patent and Trademark Office, U.S. Department of Commerce, P.O. Box 1450, Alexandria, VA 22313-1450. DO NOT SEND FEES OR COMPLETED FORMS TO THIS ADDRESS. SEND TO: Commissioner for Patents, P.O. Box 1450, Alexandria, VA 22313-1450.

If you need assistance in completing the form, call 1-800-PTO-9199 and select option 2.

APPLICATION DATA SHEET

Electronic Version v14
Stylesheet Version v14.1

Applicant Information:

Inventor 1:

Applicant Authority Type:	Inventor
Citizenship:	US
Given Name:	Bartley
Middle Name:	K.
Family Name:	ANDRE
City of Residence:	Menlo Park
State of Residence:	CA
Country of Residence:	US
Address-1 of Mailing Address:	333 Pope Street
Address-2 of Mailing Address:	
City of Mailing Address:	Menlo Park
State of Mailing Address:	CA
Postal Code of Mailing Address:	94025
Country of Mailing Address:	US
Phone:	
Fax:	
E-mail:	

Inventor 2:

Applicant Authority Type:	Inventor
Citizenship:	NZ
Given Name:	Daniel
Middle Name:	J.
Family Name:	COSTER
City of Residence:	San Francisco
State of Residence:	CA
Country of Residence:	US
Address-1 of Mailing Address:	756 Church Street
Address-2 of Mailing Address:	
City of Mailing Address:	San Francisco
State of Mailing Address:	CA

Postal Code of Mailing Address: 94114
Country of Mailing Address: US
Phone:
Fax:
E-mail:

Inventor 3:

Applicant Authority Type: Inventor
Citizenship: IT
Given Name: Daniele
Family Name: DE IULIIS
City of Residence: San Francisco
State of Residence: CA
Country of Residence: US
Address-1 of Mailing Address: 50 Digby Street
Address-2 of Mailing Address:
City of Mailing Address: San Francisco
State of Mailing Address: CA
Postal Code of Mailing Address: 94131
Country of Mailing Address: US
Phone:
Fax:
E-mail:

Inventor 4:

Applicant Authority Type: Inventor
Citizenship: GB
Given Name: Richard
Middle Name: P.
Family Name: HOWARTH
City of Residence: San Francisco
State of Residence: CA
Country of Residence: US
Address-1 of Mailing Address: 3928 17th Street
Address-2 of Mailing Address:
City of Mailing Address: San Francisco
State of Mailing Address: CA

Postal Code of Mailing Address: 94114
Country of Mailing Address: US
Phone:
Fax:
E-mail:

Inventor 5:

Applicant Authority Type: Inventor
Citizenship: GB
Given Name: Jonathan
Middle Name: P.
Family Name: IVE
City of Residence: San Francisco
State of Residence: CA
Country of Residence: US
Address-1 of Mailing Address: 196 Twin Peaks Blvd.
Address-2 of Mailing Address:
City of Mailing Address: San Francisco
State of Mailing Address: CA
Postal Code of Mailing Address: 94114
Country of Mailing Address: US
Phone:
Fax:
E-mail:

Inventor 6:

Applicant Authority Type: Inventor
Citizenship: US
Given Name: Steve
Family Name: JOBS
City of Residence: Palo Alto
State of Residence: CA
Country of Residence: US
Address-1 of Mailing Address: 2101 Waverley Street
Address-2 of Mailing Address:
City of Mailing Address: Palo Alto
State of Mailing Address: CA

Postal Code of Mailing Address: 94301
Country of Mailing Address: US
Phone:
Fax:
E-mail:

Inventor 7:

Applicant Authority Type: Inventor
Citizenship: GB
Given Name: Duncan
Middle Name: Robert
Family Name: KERR
City of Residence: San Francisco
State of Residence: CA
Country of Residence: US
Address-1 of Mailing Address: 73 Miguel Street
Address-2 of Mailing Address:
City of Mailing Address: San Francisco
State of Mailing Address: CA
Postal Code of Mailing Address: 94131
Country of Mailing Address: US
Phone:
Fax:
E-mail:

Inventor 8:

Applicant Authority Type: Inventor
Citizenship: JP
Given Name: Shin
Family Name: NISHIBORI
City of Residence: Portola Valley
State of Residence: CA
Country of Residence: US
Address-1 of Mailing Address: 28 Aliso Way
Address-2 of Mailing Address:
City of Mailing Address: Portola Valley
State of Mailing Address: CA

Postal Code of Mailing Address: 94208
Country of Mailing Address: US
Phone:
Fax:
E-mail:

Inventor 9:

Applicant Authority Type: Inventor
Citizenship: US
Given Name: Matthew
Middle Name: Dean
Family Name: ROHRBACH
City of Residence: San Francisco
State of Residence: CA
Country of Residence: US
Address-1 of Mailing Address: 29 Ora Way
Address-2 of Mailing Address:
City of Mailing Address: San Francisco
State of Mailing Address: CA
Postal Code of Mailing Address: 94131
Country of Mailing Address: US
Phone:
Fax:
E-mail:

Inventor 10:

Applicant Authority Type: Inventor
Citizenship: US
Given Name: Douglas
Middle Name: B.
Family Name: SATZGER
City of Residence: Menlo Park
State of Residence: CA
Country of Residence: US
Address-1 of Mailing Address: 225 Arden Road
Address-2 of Mailing Address:
City of Mailing Address: Menlo Park

State of Mailing Address: CA
Postal Code of Mailing Address: 94025
Country of Mailing Address: US
Phone:
Fax:
E-mail:

Inventor 11:

Applicant Authority Type: Inventor (Deceased)
Citizenship: US
Given Name: Calvin
Middle Name: Q.
Family Name: SEID
City of Residence: Palo Alto
State of Residence: CA
Country of Residence: US
Address-1 of Mailing Address: 1043 High Street
Address-2 of Mailing Address:
City of Mailing Address: Palo Alto
State of Mailing Address: CA
Postal Code of Mailing Address: 94301
Country of Mailing Address: US
Phone:
Fax:
E-mail:

Inventor 12:

Applicant Authority Type: Inventor
Citizenship: AU
Given Name: Christopher
Middle Name: J.
Family Name: STRINGER
City of Residence: Woodside
State of Residence: CA
Country of Residence: US
Address-1 of Mailing Address: 20100 Skyline Boulevard
Address-2 of Mailing Address:

City of Mailing Address: Woodside
State of Mailing Address: CA
Postal Code of Mailing Address: 94062
Country of Mailing Address: US
Phone:
Fax:
E-mail:

Inventor 13:

Applicant Authority Type: Inventor
Citizenship: CA
Given Name: Eugene
Middle Name: Antony
Family Name: WHANG
City of Residence: San Francisco
State of Residence: CA
Country of Residence: US
Address-1 of Mailing Address: #1-400 Dolores Street
Address-2 of Mailing Address:
City of Mailing Address: San Francisco
State of Mailing Address: CA
Postal Code of Mailing Address: 94114
Country of Mailing Address: US
Phone:
Fax:
E-mail:

Inventor 14:

Applicant Authority Type: Inventor
Citizenship: DE
Given Name: Rico
Family Name: ZORKENDORFER
City of Residence: San Francisco
State of Residence: CA
Country of Residence: US
Address-1 of Mailing Address: 327 Lombard Street
Address-2 of Mailing Address:

City of Mailing Address: San Francisco
State of Mailing Address: CA
Postal Code of Mailing Address: 94133
Country of Mailing Address: US
Phone:
Fax:
E-mail:

Correspondence Information:

Customer Number: 63975 *63975*

Application Information:

Title of Invention: Electronic Device
Application Type: regular, design
Attorney Docket Number: 2607.0590002(P4984USD1)/TGD/AKS

Botanic Information:

Publication Information:

Suggested Figure for Publication -
Suggested Classification -
Suggested Technology Center -
Total Number of Drawing Sheets - 8

Representative Information:

practitioner(s) at Customer Number:

63975 *63975*

as our attorney(s) or agent(s) to prosecute the application identified above, and to transact all business in the United States Patent and Trademark Office connected therewith.

Domestic Priority Information:

This is a Divisional of US application number 29/282,834, filed 2007-07-30.

US application number 29/282,834, filed 2007-07-30 is a Continuation of US application number

29/270,888, filed 2007-01-05, now U.S. Patent D558,758.

Foreign Priority Information:

Assignee Information:

Assignee 1:

Organization Name: Apple Inc.
Address-1 of Mailing Address: 1 Infinite Loop
Address-2 of Mailing Address:
City of Mailing Address: Cupertino
State of Mailing Address: CA
Postal Code of Mailing Address: 95014
Country of Mailing Address: US
Phone:
Fax:
E-mail:

Respectfully submitted,

STERNE, KESSLER, GOLDSTEIN & FOX P.L.L.C.



Tracy-Gene G. Durkin
Attorney for Applicants
Registration No. 32,831

Date: November 18, 2008

1100 New York Avenue, N.W.
Washington, D.C. 20005-3934
(202) 371-2600

902151_1.DOC

APLPROS0000011608

SPECIFICATION

[0001] This application is a divisional application of U.S. Design Patent
Application No. 29/282,834, filed July 30, 2007 (pending), which is a
continuation application of U.S. Design Patent Application No. 29/270,888,
[0002] filed January 5, 2007 (now U.S. Patent No. Des. 558,758), the disclosures of
which are all hereby incorporated in their entirety by reference thereto.

This is an application for a new, original, and ornamental design for an
[0003] ELECTRONIC DEVICE, of which the following is a specification, reference
being had to the accompanying drawings, forming a part thereof.

[0004] Figure 1 is a front perspective view of an electronic device in
[0005] accordance with the present invention;

[0006] Figure 2 is a rear perspective view thereof;

[0007] Figure 3 is a front view thereof;

[0008] Figure 4 is a rear view thereof;

[0009] Figure 5 is a top view thereof;

[0010] Figure 6 is bottom view thereof;

[0011] Figure 7 is a left side view thereof;

Figure 8 is a right side view thereof;

[0012] Figure 9 is a front perspective view of an electronic device in

[0013] accordance with the present invention;

[0014] Figure 10 is a rear perspective view thereof;

[0015] Figure 11 is a front view thereof;

[0016] Figure 12 is a rear view thereof;

[0017] Figure 13 is a top view thereof;

- [0018] Figure 14 is bottom view thereof;
- [0019] Figure 15 is a left side view thereof; and
Figure 16 is a right side view thereof.
- [0020] Figure 17 is a front perspective view of an electronic device in
accordance with the present invention;
- [0021] Figure 18 is a rear perspective view thereof;
- [0022] Figure 19 is a front view thereof;
- [0023] Figure 20 is a rear view thereof;
- [0024] Figure 21 is a top view thereof;
- [0025] Figure 22 is bottom view thereof;
- [0026] Figure 23 is a left side view thereof;
- [0027] Figure 24 is a right side view thereof;
- [0028] Figure 25 is a front perspective view of an electronic device in
accordance with the present invention;
- [0029] Figure 26 is a rear perspective view thereof;
- [0030] Figure 27 is a front view thereof;
- [0031] Figure 28 is a rear view thereof;
- [0032] Figure 29 is a top view thereof;
- [0033] Figure 30 is bottom view thereof;
- [0034] Figure 31 is a left side view thereof; and
- [0035] Figure 32 is a right side view thereof.
- [0036] The features shown in broken lines in the various Figures are for
illustrating environmental structure and form no part of the claimed design.
The dot dash lines in Figures 9 & 11 represent an indeterminate length.
- [0037] The surfaces of the electronic device are illustrated with color

designations. The grid pattern indicates the color black, the dashed line pattern indicates metal. By way of example, the metallic portions may be selected from steel, aluminum, anodized aluminum, chrome, nickel, and/or the like.

[0038] More generally, the invention pertains to an ornamental design for an article of manufacture. The article is not limited to the scale shown herein. As indicated in the title, the article of manufacture to which the ornamental design has been applied is an electronic device, media player (e.g., music, video and/or game player), media storage device, a personal digital assistant, a communication device (e.g., cellular phone), a novelty item or toy.

WE CLAIM:

The ornamental design of an electronic device, as shown and described.

895429_1.DOC

IN THE UNITED STATES PATENT AND TRADEMARK OFFICE

In re application of:

ANDRE *et al.*

Appl. No.: *To be assigned*
(Divisional of Appl. No. 29/282,834;
Filed July 30, 2007)

Filed: *Herewith*

For: **Electronic Device**

Confirmation No.: *To be assigned*

Art Unit: *To be assigned*

Examiner: *To be assigned*

Atty. Docket: 2607.0590002(P4984USD1)/TGD/AKS

**Authorization to Treat a Reply as Incorporating an
Extension of Time Under 37 C.F.R. § 1.136(a)(3)**

Commissioner for Patents
PO Box 1450
Alexandria, VA 22313-1450

Sir:

The U.S. Patent and Trademark Office is hereby authorized to treat any concurrent or future reply that requires a petition for an extension of time under this paragraph for its timely submission, as incorporating a petition for extension of time for the appropriate length of time. The U.S. Patent and Trademark Office is hereby authorized to charge all required extension of time fees to our Deposit Account No. 19-0036, if such fees are not otherwise provided for in such reply.

Respectfully submitted,

STERNE, KESSLER, GOLDSTEIN & FOX P.L.L.C.



Tracy-Gene J. Durkin
Attorney for Applicants
Registration No. 32,831

Date: November 18, 2008

1100 New York Avenue, N.W.
Washington, D.C. 20005-3934
(202) 371-2600

902150_1.DOC

APLPROS0000011613

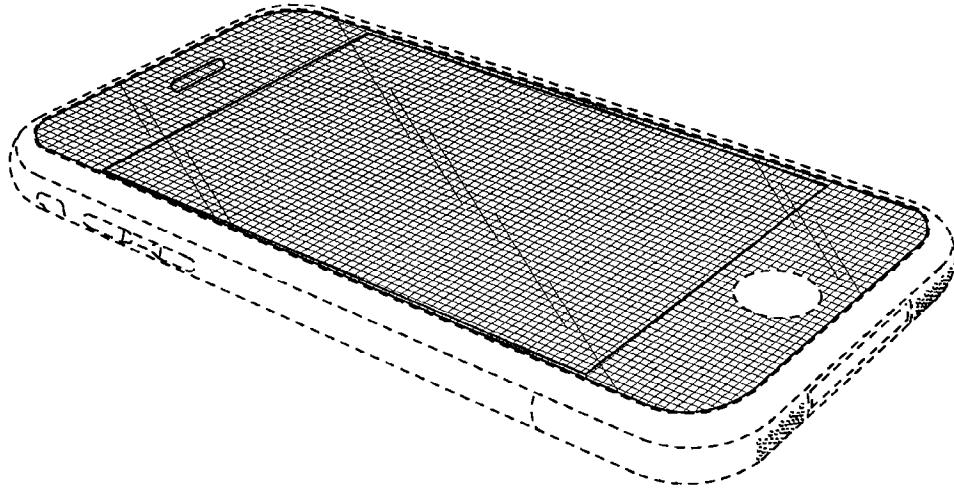

FIG. 1

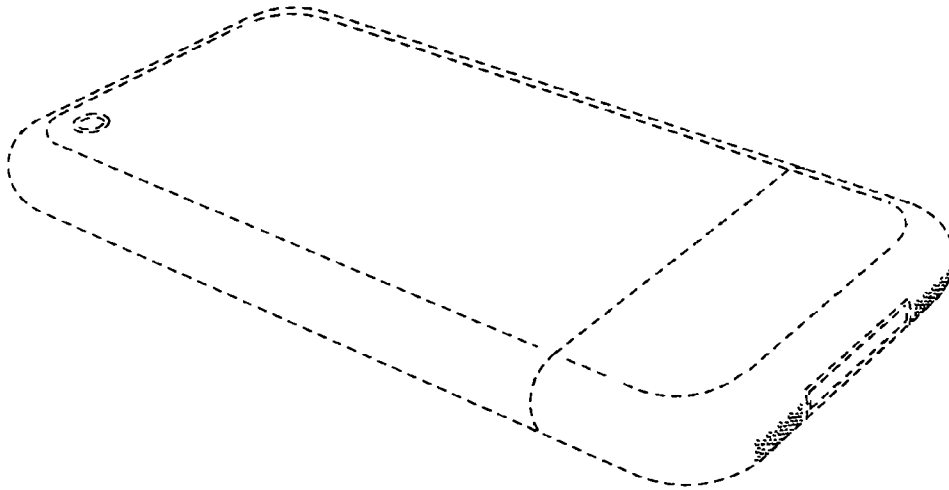

FIG. 2

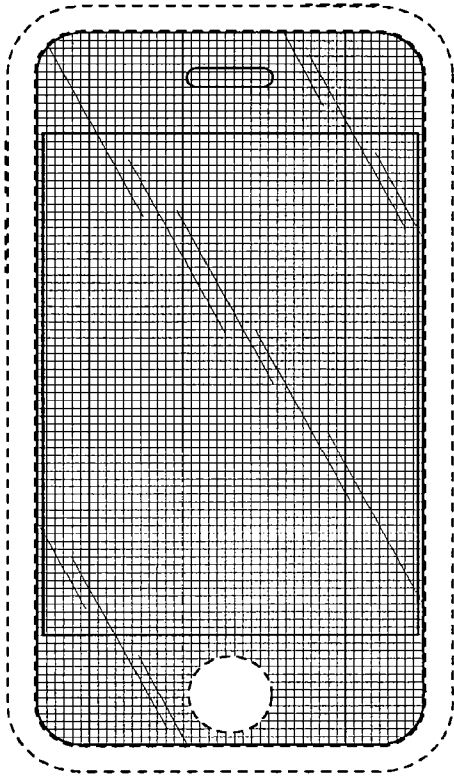

FIG. 3

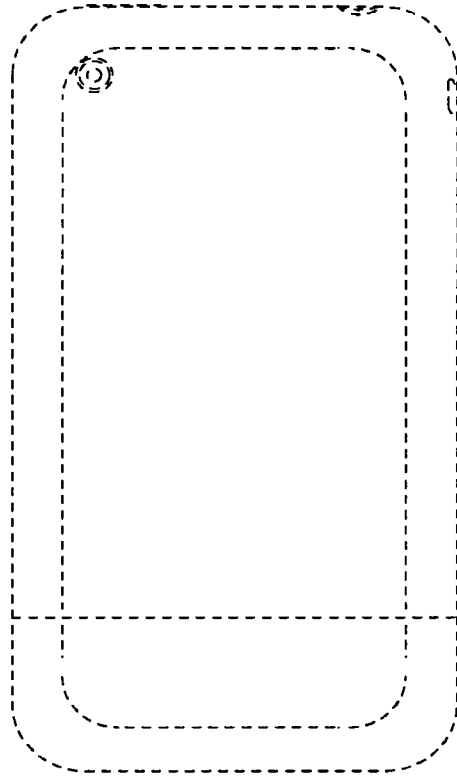

FIG. 4

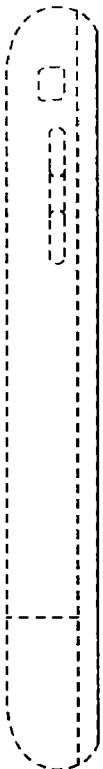

FIG. 7



FIG. 8

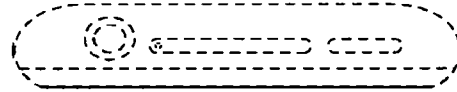

FIG. 5

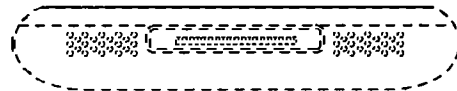

FIG. 6

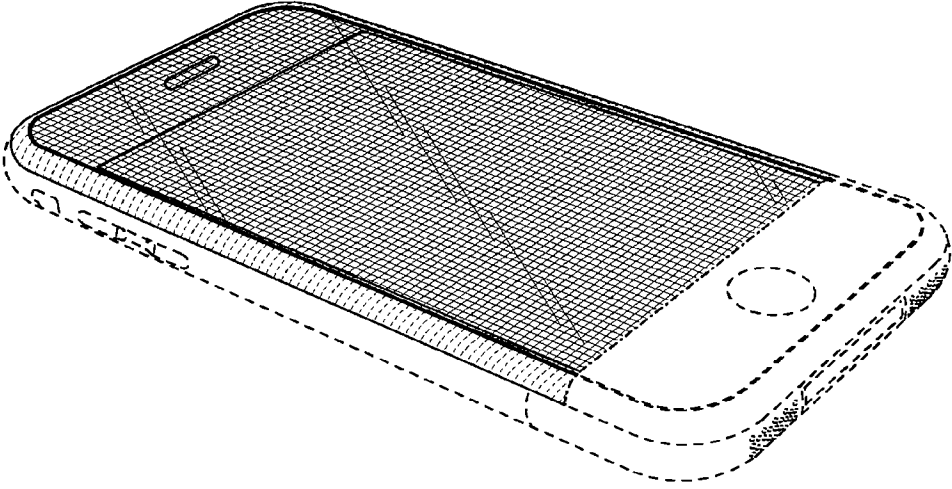

FIG. 9

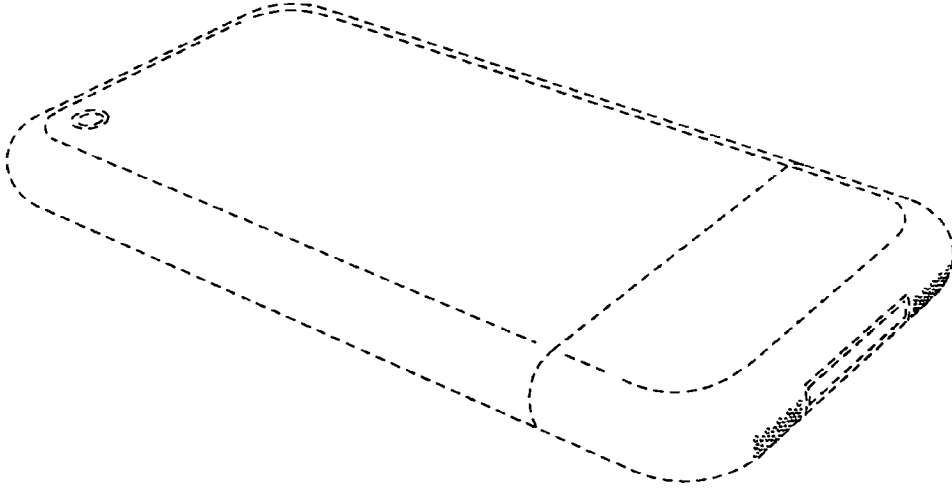

FIG. 10

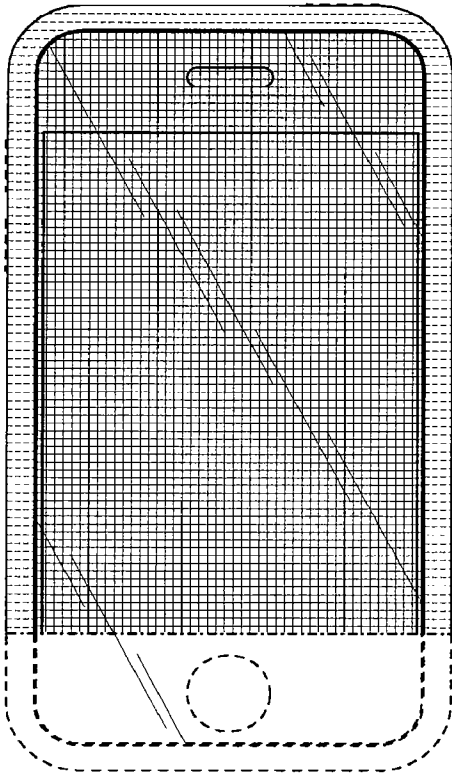

FIG. 11

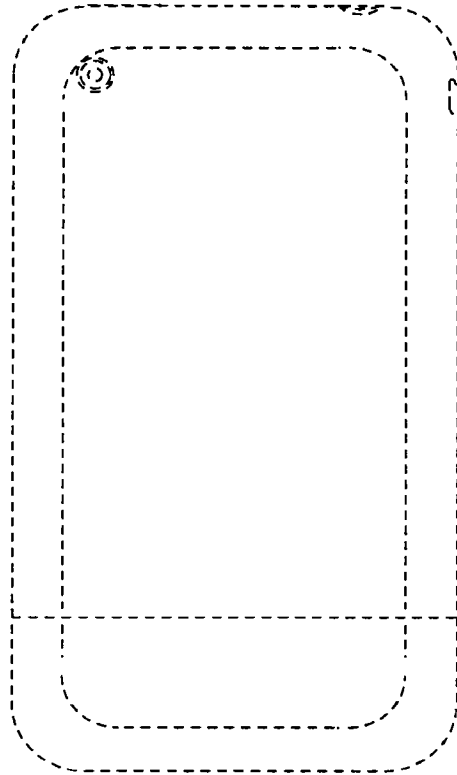

FIG. 12

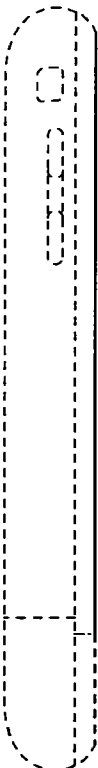

FIG. 15



FIG. 16



FIG. 13



FIG. 14

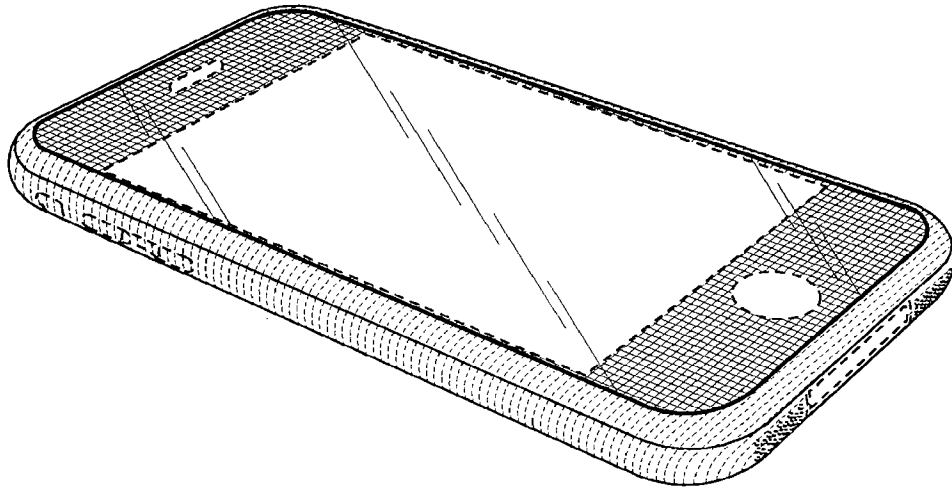

FIG. 17

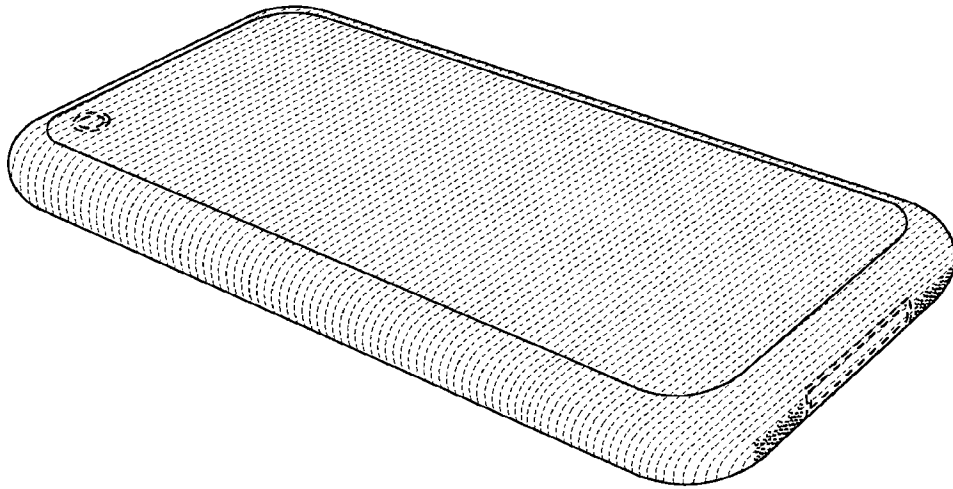

FIG. 18

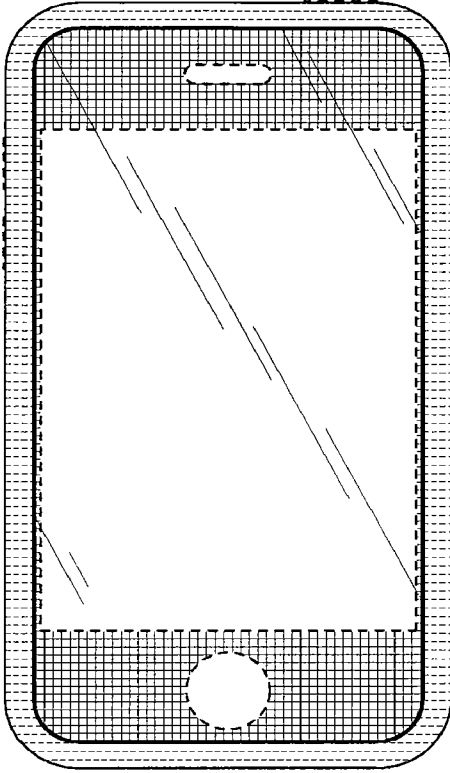

FIG. 19

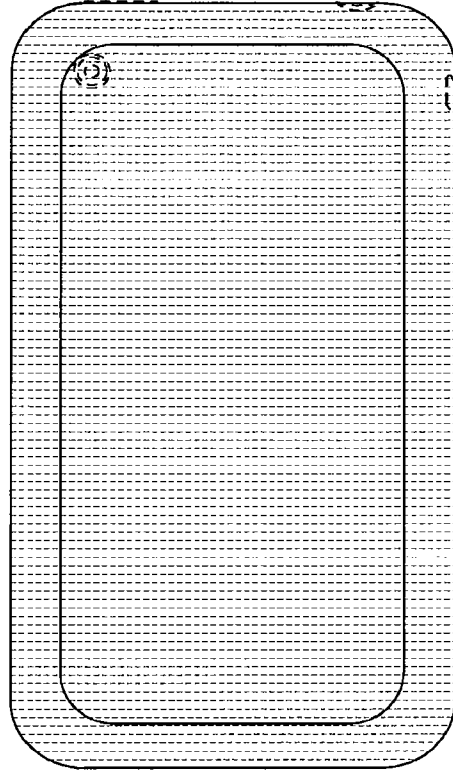

FIG. 20

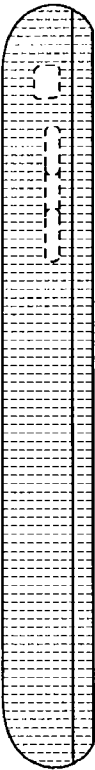

FIG. 23

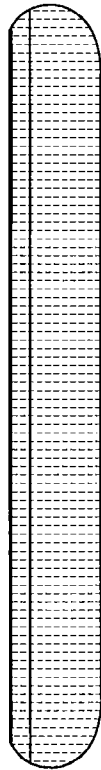

FIG. 24

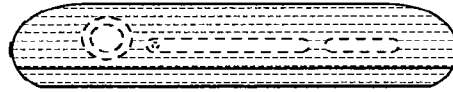

FIG. 21



FIG. 22

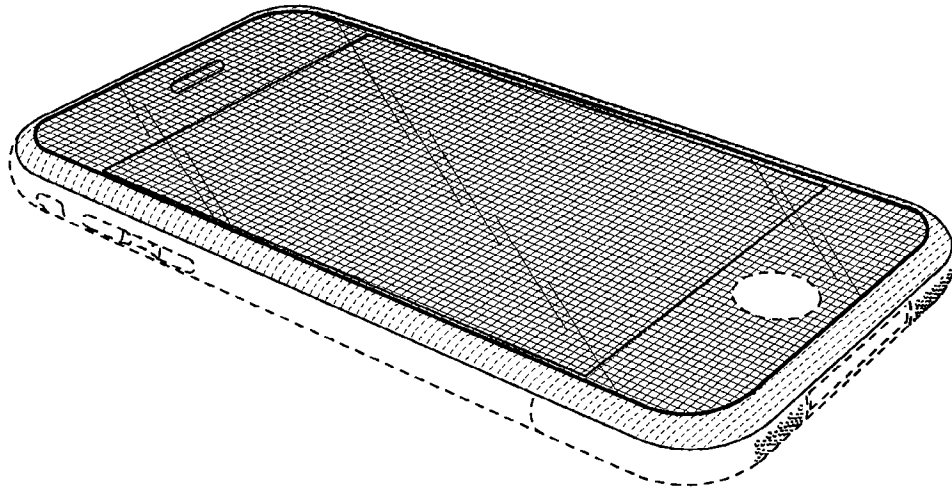

FIG. 25

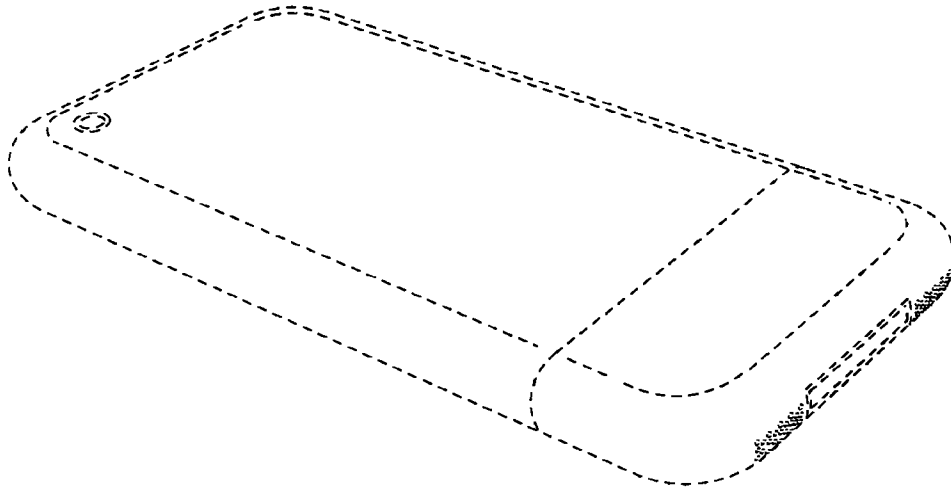

FIG. 26

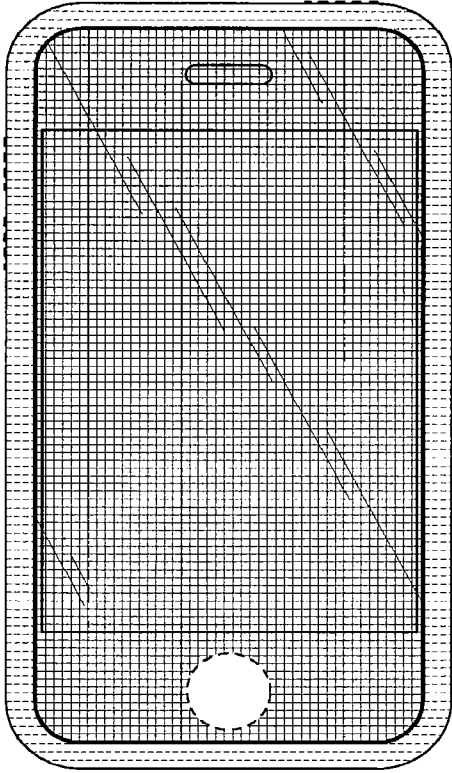

FIG. 27

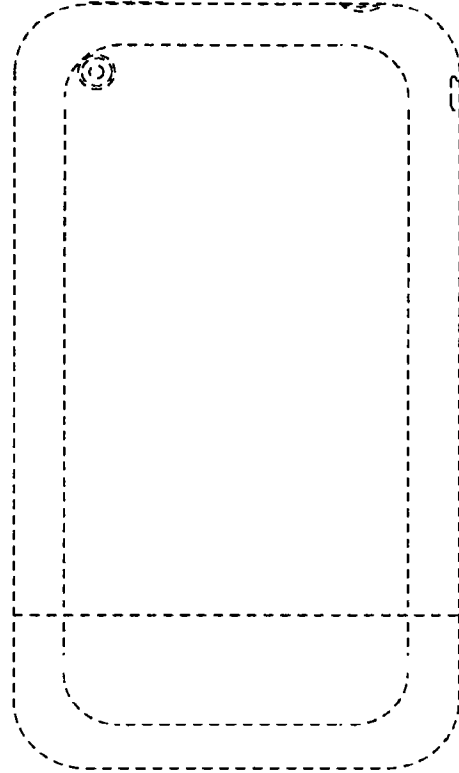

FIG. 28

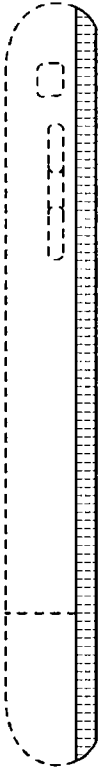

FIG. 31

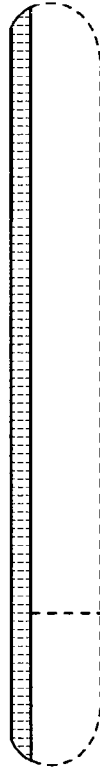

FIG. 32



FIG. 29



FIG. 30

DECLARATION FOR ORIGINAL U.S. PATENT APPLICATION

As a below-named inventor, I hereby declare that:

My residence, post office address and citizenship are as stated below next to my name.

I believe that I am the original, first and joint inventor of the subject matter which is claimed and for which a patent is sought on the invention entitled: ELECTRONIC DEVICE, the specification of which,

- (check one)
1. is attached hereto.
 2. was filed on January 5, 2007 as
U.S. Application No. 29/270,888.
 3. was filed on _____ as
PCT International Application No. _____
and was amended on _____.

I hereby state that I have reviewed and understand the contents of the above-identified specification, including the claims, as amended by any amendment referred to above.

I acknowledge the duty to disclose information which is material to patentability as defined in 37 CFR 1.56, including for continuation-in-part applications, material information which became available between the filing date of the prior application and the national or PCT international filing date of the continuation-in-part application.

Prior Foreign Application(s)

I hereby claim foreign priority benefits under Title 35, United States Code, §119(a)-(d) or (f), or §365(b) of any foreign application for patent or inventor's certificate listed below, or under §365(a) of any PCT international application which designated at least one country other than the United States listed below, and I have identified below, by checking the box, any foreign application for patent or inventor's certificate, or any PCT International application having a filing date before that of the application on which priority is claimed:

			Priority Not Claimed	Cert. Copy Attached
(Application No.)	(Country)	(Filing Date)	<input type="checkbox"/>	<input type="checkbox"/>
(Application No.)	(Country)	(Filing Date)	<input type="checkbox"/>	<input type="checkbox"/>

Direct Correspondence To:

Customer Number: 062464

Direct Telephone Calls To:

Michael J. Ferrazano at telephone number (408) 255-8001

I hereby declare that all statements made herein of my own knowledge are true and that all statements made on information and belief are believed to be true; and further that these statements were made with the knowledge that willful false statements and the like so made are punishable by fine or imprisonment, or both, under section 1001 of Title 18 of the United States Code, and that such willful false statements may jeopardize the validity of the application or any patent issuing thereon.

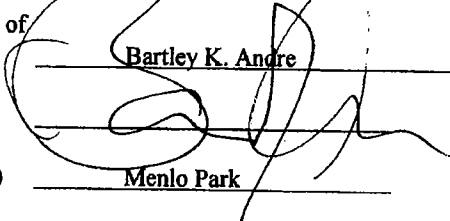
Typewritten Full Name of First Inventor: Bartley K. Andre Citizenship: U.S.
Inventor's signature:  Date of Signature: 03/27/07
Residence: (City) Menlo Park (State/Country) CA/U.S.
Address: 655 Fourteenth Ave., Menlo Park, CA 94025

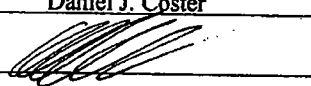
Typewritten Full Name of Second Inventor: Daniel J. Coster Citizenship: New Zealand
Inventor's signature:  Date of Signature: 03.27.06
Residence: (City) San Francisco (State/Country) CA/U.S.
Address: 471 14th Street, San Francisco, CA 94103

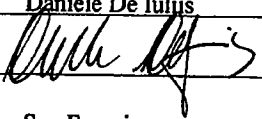
Typewritten Full Name of Third Inventor: Daniele De Iulijis Citizenship: IT
Inventor's signature:  Date of Signature: 03/22/07
Residence: (City) San Francisco (State/Country) CA/U.S.
Address: 50 Digby Street, San Francisco, CA 94131

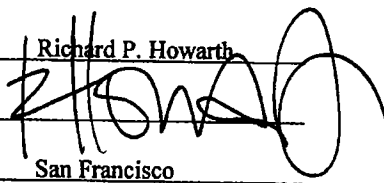
Typewritten Full Name of Fourth Inventor: Richard P. Howarth Citizenship: Great Britain
Inventor's signature:  Date of Signature: 3.27.07
Residence: (City) San Francisco (State/Country) CA/U.S.
Address: 3928 17th Street, San Francisco, CA 94114

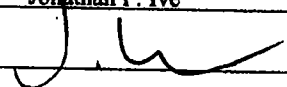
Typewritten Full Name of Fifth Inventor: Jonathan P. Ive Citizenship: Great Britain
Inventor's signature:  Date of Signature: 3-30-07
Residence: (City) San Francisco (State/Country) CA/U.S.
Address: 196 Twin Peaks Blvd., San Francisco, CA 94114

Typewritten Full Name of Sixth Inventor: Steve Jobs Citizenship: U.S.
Inventor's signature: _____ Date of Signature: _____
Residence: (City) Palo Alto (State/Country) CA/U.S.
Address: 2101 Waverley Street, Palo Alto, CA 94301

Typewritten Full Name of Seventh Inventor: Duncan Robert Kerr Citizenship: Great Britain
Inventor's signature:  Date of Signature: 3-29-7
Residence: (City) San Francisco (State/Country) CA/U.S.
Address: 2600 18th Street, #15, San Francisco, CA 94110

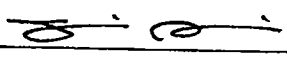
Typewritten Full Name of Eighth Inventor: Shin Nishibori Citizenship: Japan
Inventor's signature:  Date of Signature: 2-27-07
Residence: (City) San Francisco (State/Country) CA/U.S.
Address: 248 Amber Drive, San Francisco, CA 94131

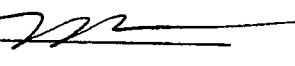
Typewritten Full Name of Ninth Inventor: Matthew Dean Rohrbach Citizenship: U.S.
Inventor's signature:  Date of Signature: 03-27-07
Residence: (City) San Francisco (State/Country) CA/U.S.
Address: 29 Ora Way, San Francisco, CA 94131

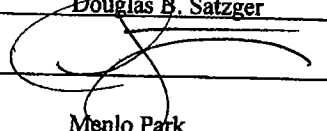
Typewritten Full Name of Tenth Inventor: Douglas B. Satzger Citizenship: U.S.
Inventor's signature:  Date of Signature: 03-28-07
Residence: (City) Menlo Park (State/Country) CA/U.S.
Address: 225 Arden Road, Menlo Park, CA 94025

Typewritten Full Name of Eleventh Inventor: Calvin O. Seid Citizenship: U.S.
Inventor's signature:  Date of Signature: 2-28-07
Residence: (City) Palo Alto (State/Country) CA/U.S.
Address: 1043 High Street, Palo Alto, CA 94301

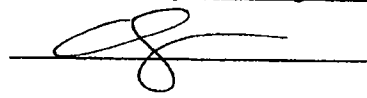
Typewritten Full Name of Twelfth Inventor: Christopher J. Stringer Citizenship: Australia
Inventor's signature:  Date of Signature: 2-27-07
Residence: (City) Portola Valley (State/Country) CA/U.S.
Address: 320 Cervantes Road, Portola Valley, CA 94028

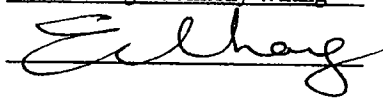
Typewritten Full Name of Thirteenth Inventor: Eugene Antony Whang Citizenship: Canada
Inventor's signature:  Date of Signature: 3-27-07
Residence: (City) San Francisco (State/Country) CA/U.S.
Address: #1-400 Dolores Street, San Francisco, CA 94114

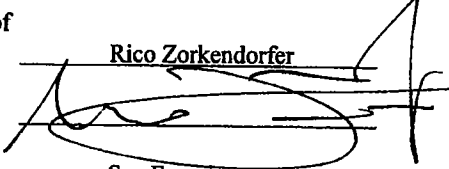
Typewritten Full Name of Fourteenth Inventor: Rico Zorkendorfer Citizenship: Germany
Inventor's signature:  Date of Signature: 02.27.07
Residence: (City) San Francisco (State/Country) CA/U.S.
Address: 327 Lombard Street, San Francisco, CA 94133