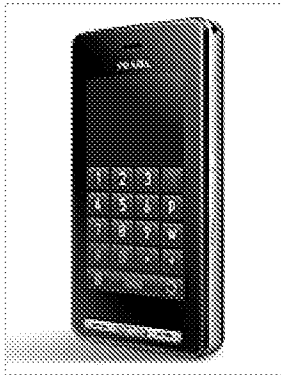


- Nokia
- Samsung
- Motorola
- Sony
- Ericsson
- LG
- Alcatel
- Panasonic
- BenQ
- Siemens
- Siemens
- BenQ
- Philips
- NEC
- Sagem
- Sharp
- Toshiba
- Pantech
- VK Mobile
- Palm
- HTC
- Ctek
- i-mate
- O2
- BlackBerry
- Haier
- Bird
- Eten
- HP
- Xcute
- Asus
- Gigabyte
- Apple
- more
- PHONE FINDER

LG KE850 Prada



- [Read opinions](#)
- [Compare](#)
- [Pictures](#)
- [Video \(new!\)](#)
- CHECK PRICE**
- [Bargain Offers](#)
- [WElectronics](#)
- [Mobileshop.com \(UK\)](#)
- [CTI Miami](#)
- [Mobile Gadgets](#)
- [B4Utele \(UK\)](#)
- [Plenix](#)
- [Cellswholesale](#)
- [Popular Electronics](#)
- [BuyMobilePhones\(UK\)](#)
- [Samstores](#)
- [Mobideal \(UK\)](#)
- [Bombay Electronics](#)

**VOTING RESULTS**

Design	<div style="width: 84%;"></div>	8.4
Features	<div style="width: 75%;"></div>	7.5
Performance	<div style="width: 76%;"></div>	7.6

Votes: 2435 Hits: 564587

Vote!

GENERAL	Network	GSM 900 / GSM 1800 / GSM 1900
	Announced	2007, January
	Status	Available
SIZE	Dimensions	98.8 x 54 x 12 mm
	Weight	85 g
DISPLAY	Type	TFT touchscreen, 256K colors
	Size	240 x 400 pixels, 3 inches
		- Capacitive touchscreen
		- Flash UI
		- Downloadable wallpapers
RINGTONES	Type	Polyphonic (40 channels), MP3
	Customization	Composer, Download
	Vibration	Yes
MEMORY	Phonebook	1000 entries
	Call records	40 dialed, 40 received, 40 missed calls
	Card slot	microSD (TransFlash), 256 MB card included, buy memory
		- 16 MB shared memory
DATA	GPRS	Class 10 (4+1/3+2 slots), 32 - 48 kbps
	HSCSD	No
	EDGE	Yes
	3G	No
	WLAN	No
	Bluetooth	Yes, v2.0 with A2DP
	infrared port	No
	USB	Yes, v2.0
FEATURES	Messaging	SMS, EMS, MMS, Email
	Browser	WAP 2.0/xHTML
	Games	Yes, order now
	Colors	Black
	Camera	2 MP, 1600x1200 pixels, video(30fps), flash
		- Java MIDP 2.0
		- MP3/ACC/WMA player
		- FM radio
		- Document viewer (.ppt, .doc, .xls, .pdf, .txt)
		- Organiser
		- Voice memo
		- Built-in handsfree
BATTERY		Standard battery, Li-Ion 800 mAh
	Stand-by	Up to 300 h
	Talk time	Up to 3 h

Disclaimer: We can not guarantee that the information on this page is 100% correct. [Read more](#)

LG KE850 PRADA - USER OPINIONS AND REVIEWS

does it come with prada pouch or other accessories? if not i seriously think its not worth the money at all. its so expensive here in Singapore, almost S\$1300 or abt EU\$645, without contract...hold man, it'll sure drop well below S\$600 in a few mont...

2007-05-17 02:24:25 Email

Billy, the link for the invisible shield was posted by Alex earlier. It's a super tough sticky clear film, custom made for the Prada and other devices. Relatively OK to apply, as long as you use plenty of the spray provided. It comes with instruct...

2007-05-17 00:35:48 Protex Email

*Amendments to the Drawings*

Please replace Figures 1 through Figure 8 with new Figures 1 through 96 enclosed herewith.

***Remarks***

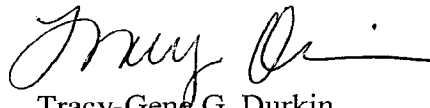
Upon entry of the foregoing amendment, one claim is pending in the application. Paragraphs [0009] and [0010] have been amended, paragraphs [0011] and [0012] have been renumbered to paragraphs [0099] and [0100], and new paragraphs [0011] through [0098] have been added. Figures 1 through 8 have been replaced with new Figures 1 through 96. These changes are believed to introduce no new matter, and their entry is respectfully requested.

***Conclusion***

Prompt and favorable consideration of this Preliminary Amendment is respectfully requested. If the Examiner believes, for any reason, that personal communication will expedite prosecution of this application, the Examiner is invited to telephone the undersigned at the number provided.

Respectfully submitted,

STERNE, KESSLER, GOLDSTEIN & FOX P.L.L.C.



Tracy-Gene G. Durkin  
Attorney for Applicants  
Registration No. 32,831

Date: November 30, 2007

1100 New York Avenue, N.W.  
Washington, D.C. 20005-3934  
(202) 371-2600

753539\_1.DOC

Atty. Dkt. No. 2607.0600001(P4984USC3)

APLPROS0000010487

***Amendments to the Specification***

Please amend paragraphs [0009] through [0010], as follows:

[0009] Figure 7 is a left side view thereof; [and]

[0010] Figure 8 is a right side view thereof;[.]

Please renumber paragraphs [0011] through [0012] as follows:

[0011] The features shown in broken lines in the various Figures are for illustrating environmental structure and form no part of the claimed design.

[0012] More generally, the invention pertains to an ornamental design for an article of manufacture. The article of manufacture can vary widely. The design can also be scaled to different sizes depending on the article of manufacture. In one embodiment, as indicated above, the article of manufacture is an electronic device. Examples of an electronic device are a computer, a portable or hand-held electronic device, media player (e.g., music, video and/or game player), media storage device, a personal digital assistant, a communication device (e.g., cellular phone), and/or the like. In another embodiment, the article of manufacture is a novelty item or toy. The inventors anticipate that the invention can be any part, portion, element, or combination of elements of the depicted design.

Please add new paragraphs [0011] through [0098] as follows:

[0011] Figure 9 is a front perspective view of another embodiment of an electronic device in accordance with the present invention;

[0012] Figure 10 is a rear perspective view of the electronic device in  
Figure 9;

[0013] Figure 11 is a front view thereof;

[0014] Figure 12 is a rear view thereof;

[0015] Figure 13 is a top view thereof;

[0016] Figure 14 is bottom view thereof;

[0017] Figure 15 is a left side view thereof;

[0018] Figure 16 is a right side view thereof,

[0019] Figure 17 is a front perspective view of another embodiment of an  
electronic device in accordance with the present invention;

[0020] Figure 18 is a rear perspective view of the electronic device in  
Figure 17;

[0021] Figure 19 is a front view thereof;

[0022] Figure 20 is a rear view thereof;

[0023] Figure 21 is a top view thereof;

[0024] Figure 22 is bottom view thereof;

[0025] Figure 23 is a left side view thereof;

[0026] Figure 24 is a right side view thereof;

[0027] Figure 25 is a front perspective view of another embodiment of an  
electronic device in accordance with the present invention;

[0028] Figure 26 is a rear perspective view of the electronic device in  
Figure 25;

[0029] Figure 27 is a front view thereof;

- [0030] Figure 28 is a rear view thereof;
- [0031] Figure 29 is a top view thereof;
- [0032] Figure 30 is bottom view thereof;
- [0033] Figure 31 is a left side view thereof;
- [0034] Figure 32 is a right side view thereof;
- [0035] Figure 33 is a front perspective view of another embodiment of an electronic device in accordance with the present invention;
- [0036] Figure 34 is a rear perspective view of the electronic device in Figure 33;
- [0037] Figure 35 is a front view thereof;
- [0038] Figure 36 is a rear view thereof;
- [0039] Figure 37 is a top view thereof;
- [0040] Figure 38 is bottom view thereof;
- [0041] Figure 39 is a left side view thereof;
- [0042] Figure 40 is a right side view thereof;
- [0043] Figure 41 is a front perspective view of another embodiment of an electronic device in accordance with the present invention;
- [0044] Figure 42 is a rear perspective view of the electronic device in Figure 41;
- [0045] Figure 43 is a front view thereof;
- [0046] Figure 44 is a rear view thereof;
- [0047] Figure 45 is a top view thereof;
- [0048] Figure 46 is bottom view thereof;

- [0049] Figure 47 is a left side view thereof;
- [0050] Figure 48 is a right side view thereof;
- [0051] Figure 49 is a front perspective view of another embodiment of an electronic device in accordance with the present invention;
- [0052] Figure 50 is a rear perspective view of the electronic device in Figure 49;
- [0053] Figure 51 is a front view thereof;
- [0054] Figure 52 is a rear view thereof;
- [0055] Figure 53 is a top view thereof;
- [0056] Figure 54 is bottom view thereof;
- [0057] Figure 55 is a left side view thereof;
- [0058] Figure 56 is a right side view thereof;
- [0059] Figure 57 is a front perspective view of another embodiment of an electronic device in accordance with the present invention;
- [0060] Figure 58 is a rear perspective view of the electronic device in Figure 57;
- [0061] Figure 59 is a front view thereof;
- [0062] Figure 60 is a rear view thereof;
- [0063] Figure 61 is a top view thereof;
- [0064] Figure 62 is bottom view thereof;
- [0065] Figure 63 is a left side view thereof;
- [0066] Figure 64 is a right side view thereof;

[0067] Figure 65 is a front perspective view of another embodiment of an electronic device in accordance with the present invention;

[0068] Figure 66 is a rear perspective view of the electronic device in Figure 65;

[0069] Figure 67 is a front view thereof;

[0070] Figure 68 is a rear view thereof;

[0071] Figure 69 is a top view thereof;

[0072] Figure 70 is bottom view thereof;

[0073] Figure 71 is a left side view thereof;

[0074] Figure 72 is a right side view thereof;

[0075] Figure 73 is a front perspective view of another embodiment of an electronic device in accordance with the present invention;

[0076] Figure 74 is a rear perspective view of the electronic device in Figure 73;

[0077] Figure 75 is a front view thereof;

[0078] Figure 76 is a rear view thereof;

[0079] Figure 77 is a top view thereof;

[0080] Figure 78 is bottom view thereof;

[0081] Figure 79 is a left side view thereof;

[0082] Figure 80 is a right side view thereof;

[0083] Figure 81 is a front perspective view of another embodiment of an electronic device in accordance with the present invention;



- [0084] Figure 82 is a rear perspective view of the electronic device in  
Figure 81;
- [0085] Figure 83 is a front view thereof;
- [0086] Figure 84 is a rear view thereof;
- [0087] Figure 85 is a top view thereof;
- [0088] Figure 86 is bottom view thereof;
- [0089] Figure 87 is a left side view thereof;
- [0090] Figure 88 is a right side view thereof;
- [0091] Figure 89 is a front perspective view of another embodiment of an  
electronic device in accordance with the present invention;
- [0092] Figure 90 is a rear perspective view of the electronic device in  
Figure 89;
- [0093] Figure 91 is a front view thereof;
- [0094] Figure 92 is a rear view thereof;
- [0095] Figure 93 is a top view thereof;
- [0096] Figure 94 is bottom view thereof;
- [0097] Figure 95 is a left side view thereof; and
- [0098] Figure 96 is a right side view thereof.

IN THE UNITED STATES PATENT AND TRADEMARK OFFICE

In re application of:

ANDRE *et al.*

Appl. No.: 29/282,833

Filed: July 30, 2007

For: **Electronic Device**

Confirmation No.: 3463

Art Unit: 2911

Examiner: Eland, Bridget L.

Atty. Docket: 2607.0600001(P4984USC3)

**Preliminary Amendment Under 37 C.F.R. § 1.115**

Commissioner for Patents  
PO Box 1450  
Alexandria, VA 22313-1450

Sir:

In advance of prosecution, Applicant submits the following amendment and remarks. This Preliminary Amendment is provided in the following format:

- (A) Each section begins on a separate sheet;
- (B) Starting on a separate sheet, amendments to the specification by presenting replacement paragraphs marked up to show changes made;
- (C) Starting on a separate sheet, the Remarks.

It is not believed that extensions of time or fees for net addition of claims are required beyond those that may otherwise be provided for in documents accompanying this paper. However, if additional extensions of time are necessary to prevent abandonment of this application, then such extensions of time are hereby petitioned under 37 C.F.R. § 1.136(a), and any fees required therefor (including fees for net addition of claims) are hereby authorized to be charged to our Deposit Account No. 19-0036.

IN THE UNITED STATES PATENT AND TRADEMARK OFFICE

In re application of:

ANDRE *et al.*

Appl. No.: 29/282,833

Filed: July 30, 2007

For: **Electronic Device**

Confirmation No.: 3463

Art Unit: 2916

Examiner: Eland, Bridget L.

Atty. Docket: 2607.00600001(P4984USC3)

**Submission of Drawings**

*Mail Stop Amendment*

Commissioner for Patents  
PO Box 1450  
Alexandria, VA 22313-1450

Sir:

Submitted herewith are twenty-four sheets of Replacement drawings with Figures **1 through 96**, replacing the originally submitted Figures 1 through 8 filed in the above-captioned application. Identification of the drawings is provided in accordance with 37 C.F.R. § 1.84(c). Acknowledgment of the receipt, approval, and entry of these drawings into this application is respectfully requested.

Respectfully submitted,

STERNE, KESSLER, GOLDSTEIN & FOX P.L.L.C.



Tracy-Gene G. Durkin  
Attorney for Applicants  
Registration No. 32,831

Date: November 30, 2007

1100 New York Avenue, N.W.  
Washington, D.C. 20005-3934  
(202) 371-2600

753537\_1.DOC

APLPROS0000010495



Robert Greene Sterne  
Jorge A. Goldstein  
David K.S. Cornwell  
Robert W. Esmond  
Tracy-Gene G. Durkin  
Michele A. Cimballa  
Michael B. Ray  
Robert E. Sokohl  
Eric K. Steffe  
Michael Q. Lee  
John M. Covert  
Robert C. Millonig  
Donald J. Featherstone  
Timothy J. Shea, Jr  
Michael V. Messinger  
Judith U. Kim  
Jeffrey T. Helvey  
Eldora L. Ellison

Donald R. Banowit  
Peter A. Jackman  
Brian J. Del Buono  
Mark Fox Evens  
Vincent L. Capuano  
Elizabeth J. Haanes  
Michael D. Specht  
Kevin W. McCabe  
Glenn J. Perry  
Edward W. Yee  
Grant E. Reed  
Virgil Lee Beaston  
Theodore A. Wood  
Joseph S. Ostroff  
Jason D. Eisenberg  
Tracy L. Muller  
Jon E. Wright  
LuAnne M. DeSantis

Ann E. Summerfield  
Helene C. Carlson  
Cynthia M. Bouchez  
Timothy A. Doyle  
Gaby L. Longworth  
Lori A. Gordon  
Laura A. Vogel  
Bashir M.S. Ali  
Shannon A. Carroll  
Anbar F. Khal  
Michelle K. Holoubek  
Marsha A. Rose  
Scott A. Schaller  
Lei Zhou  
W. Blake Coblenz  
James J. Pohl  
John T. Haran  
Mark W. Rygiel

Michael R. Malek\*  
Carla Ji-Eun Kim  
Doyle A. Siever\*  
Ulrike Winkler Jenks  
Paul A. Calvo  
Robert A. Schwartzman  
C. Matthew Rozier\*  
Shameek Ghose  
Randall K. Baldwin  
Daniel J. Nevrivy  
  
**Registered Patent Agents\***  
Karen R. Markowicz  
Matthew J. Dowd  
Mita Mukherjee  
Scott M. Woodhouse  
Peter A. Socarras  
Jeffrey K. Mills

Danielle L. Letting  
Lori Brandes  
Steven C. Oppenheimer  
Aaron S. Lukas  
Gaurav Asthana  
Robert E. Bakin  
Salvador M. Bezos  
  
**Of Counsel**  
Edward J. Kessler  
Kenneth C. Bass III  
Marvin C. Guthrie  
Christopher P. Wrist

\*Admitted only in Maryland  
\*Admitted only in Virginia  
•Practice Limited to Federal Agencies

November 30, 2007

**WRITER'S DIRECT NUMBER:**  
(202) 772-8660  
**INTERNET ADDRESS:**  
TDURKIN@SKGF.COM

Commissioner for Patents  
PO Box 1450  
Alexandria, VA 22313-1450

**Art Unit 2916**  
**Mail Stop Amendment**

Re: U.S. Design Patent Application  
Application No. 29/282,833; Filed: July 30, 2007  
For: **Electronic Device**  
Inventor: **ANDRE et al.**  
Our Ref: 2607.0600001(P4984USC3)

Sir:

Transmitted herewith for appropriate action are the following documents:

1. Preliminary Amendment Under 37 C.F.R. §1.115;
2. Submission of Drawings; and
3. Twenty-four (24) sheets of Replacement Drawings (Figs. 1-96).

***The above-listed documents are filed electronically through EFS-Web.***

In the event that extensions of time are necessary to prevent abandonment of this patent application, then such extensions of time are hereby petitioned.

The U.S. Patent and Trademark Office is hereby authorized to charge any fee deficiency, or credit any overpayment, to our Deposit Account No. 19-0036.

Respectfully submitted,

STERNE, KESSLER, GOLDSTEIN & FOX P.L.L.C.

Tracy-Gene G. Durkin  
Attorney for Applicants  
Registration No. 32,831

TGD/BKB:kim  
Enclosures  
753535\_1.DOC

## Electronic Acknowledgement Receipt

<b>EFS ID:</b>	2534321
<b>Application Number:</b>	29282833
<b>International Application Number:</b>	
<b>Confirmation Number:</b>	3463
<b>Title of Invention:</b>	Electronic Device
<b>First Named Inventor/Applicant Name:</b>	Bartley K. ANDRE
<b>Customer Number:</b>	63975
<b>Filer:</b>	Tracy-Gene G. Durkin/Brian Baxter
<b>Filer Authorized By:</b>	Tracy-Gene G. Durkin
<b>Attorney Docket Number:</b>	2607.0600001(P4984USC3)/T
<b>Receipt Date:</b>	30-NOV-2007
<b>Filing Date:</b>	30-JUL-2007
<b>Time Stamp:</b>	18:15:37
<b>Application Type:</b>	Design

### Payment information:

Submitted with Payment	no
------------------------	----

### File Listing:

Document Number	Document Description	File Name	File Size(Bytes) /Message Digest	Multi Part /.zip	Pages (if appl.)
1		20670600001 PrelimAmendD wgs.pdf	739580 <small>ee7355143ded065f4fc22179c4aaef39e 2c36f19</small>	yes	35

<b>Multipart Description/PDF files in .zip description</b>			
<b>Document Description</b>		<b>Start</b>	<b>End</b>
Miscellaneous Incoming Letter		1	1
Preliminary Amendment		2	10
Drawings-only black and white line drawings		11	35

**Warnings:**

**Information:**

**Total Files Size (in bytes):**

739580

**This Acknowledgement Receipt evidences receipt on the noted date by the USPTO of the indicated documents, characterized by the applicant, and including page counts, where applicable. It serves as evidence of receipt similar to a Post Card, as described in MPEP 503.**

**New Applications Under 35 U.S.C. 111**

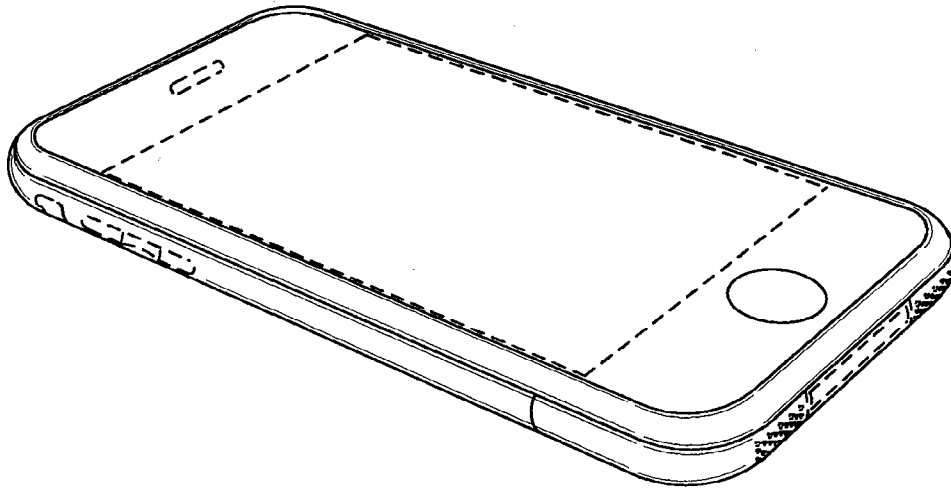
**If a new application is being filed and the application includes the necessary components for a filing date (see 37 CFR 1.53(b)-(d) and MPEP 506), a Filing Receipt (37 CFR 1.54) will be issued in due course and the date shown on this Acknowledgement Receipt will establish the filing date of the application.**

**National Stage of an International Application under 35 U.S.C. 371**

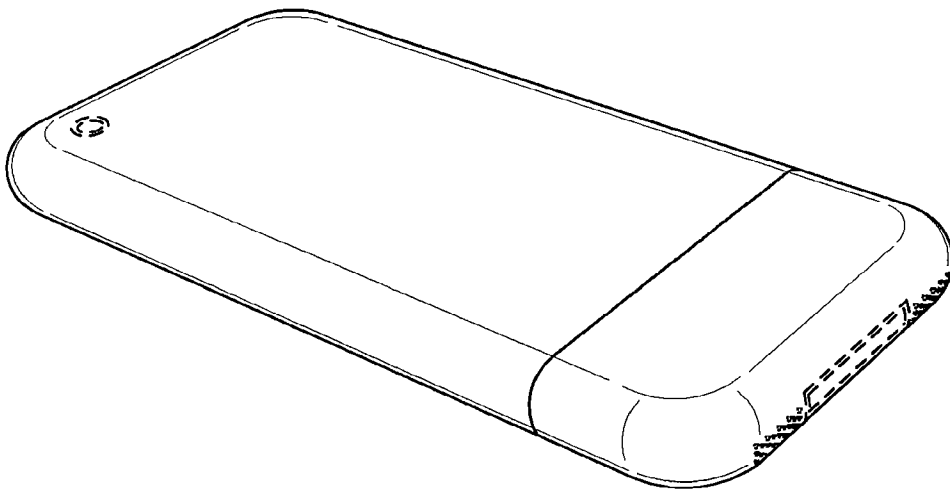
**If a timely submission to enter the national stage of an international application is compliant with the conditions of 35 U.S.C. 371 and other applicable requirements a Form PCT/DO/EO/903 indicating acceptance of the application as a national stage submission under 35 U.S.C. 371 will be issued in addition to the Filing Receipt, in due course.**

**New International Application Filed with the USPTO as a Receiving Office**

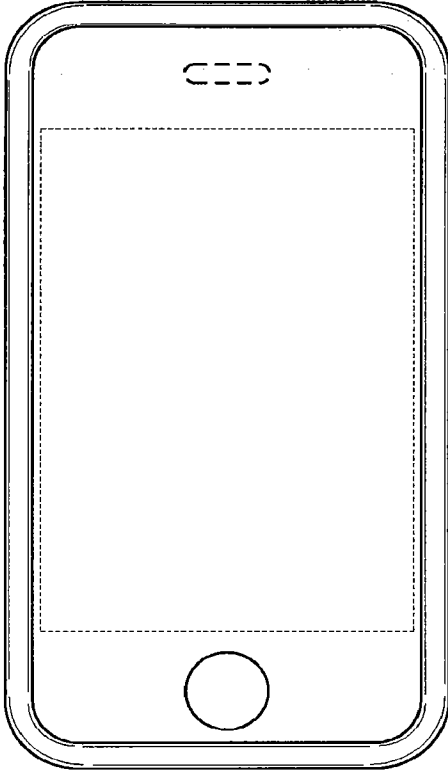
**If a new international application is being filed and the international application includes the necessary components for an international filing date (see PCT Article 11 and MPEP 1810), a Notification of the International Application Number and of the International Filing Date (Form PCT/RO/105) will be issued in due course, subject to prescriptions concerning national security, and the date shown on this Acknowledgement Receipt will establish the international filing date of the application.**



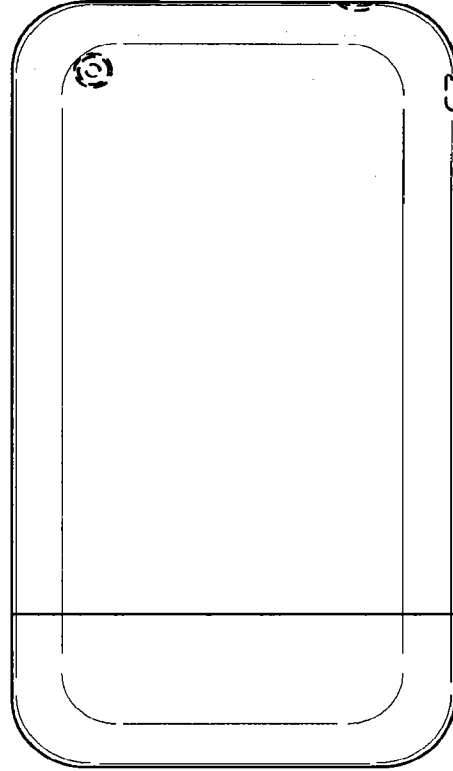
**FIG. 1**



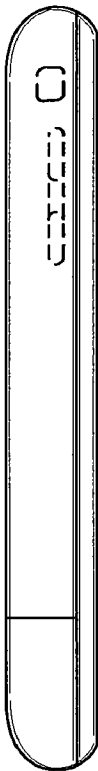
**FIG. 2**



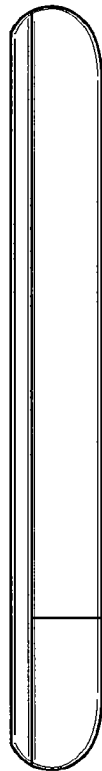
**FIG. 3**



**FIG. 4**



**FIG. 7**



**FIG. 8**

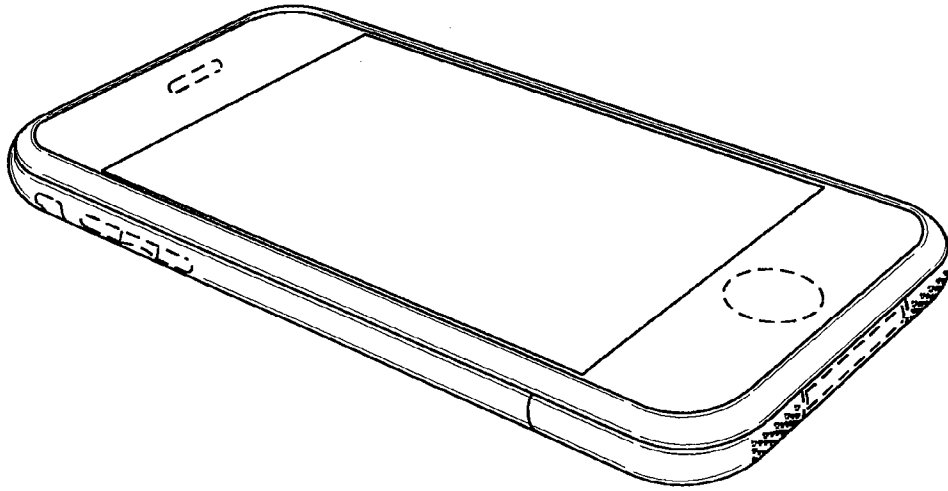


**FIG. 5**

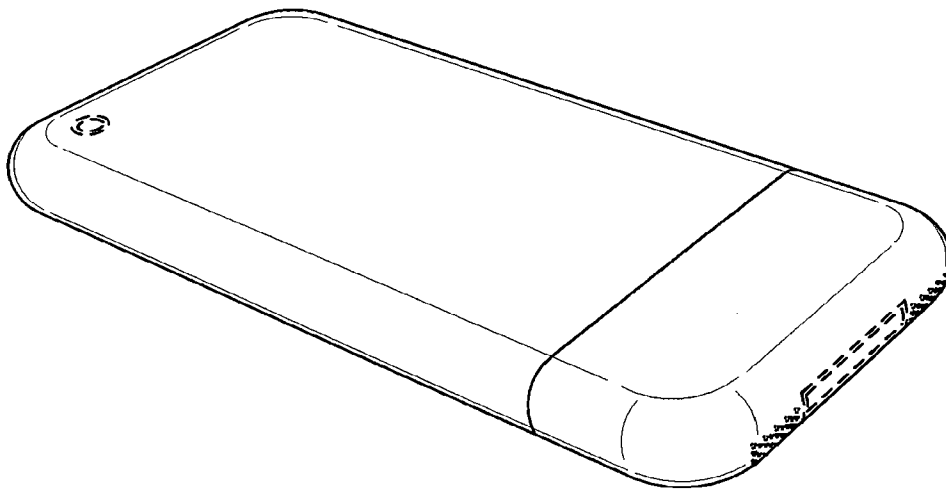


**FIG. 6**

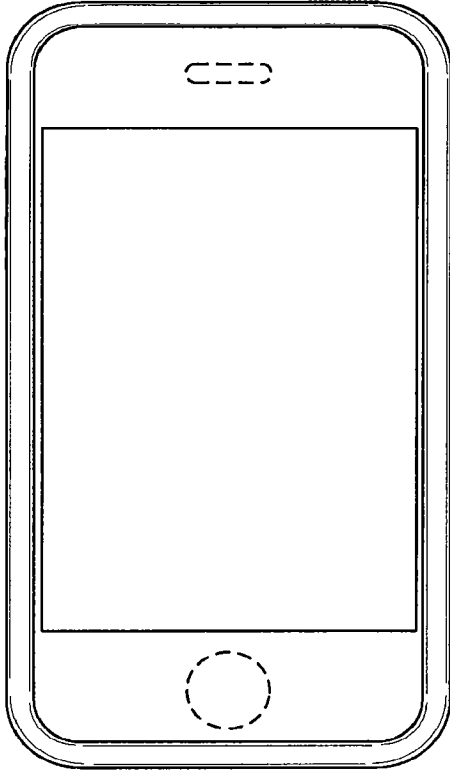




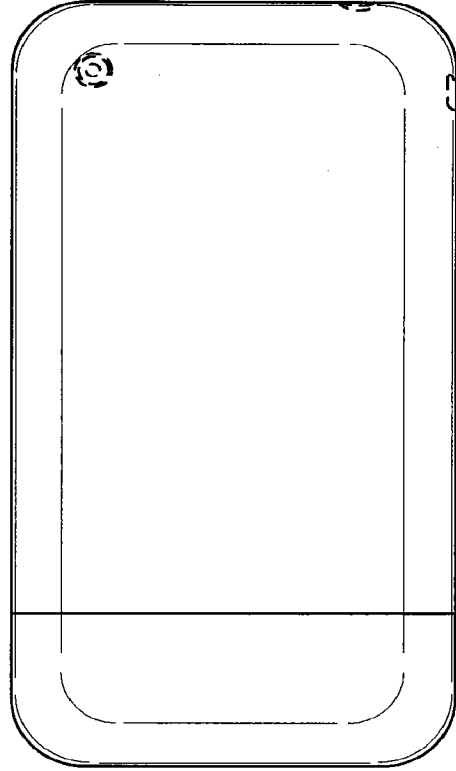
**FIG. 9**



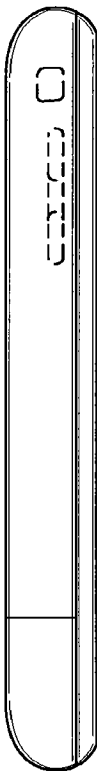
**FIG. 10**



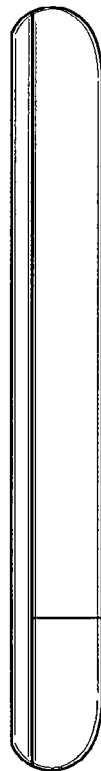
**FIG. 11**



**FIG. 12**



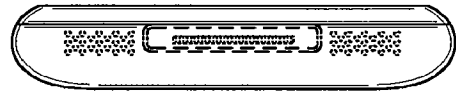
**FIG. 15**



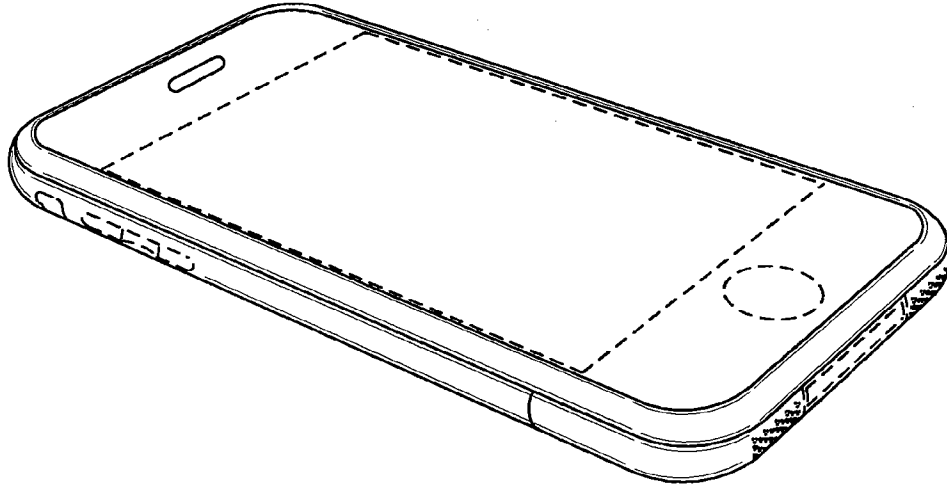
**FIG. 16**



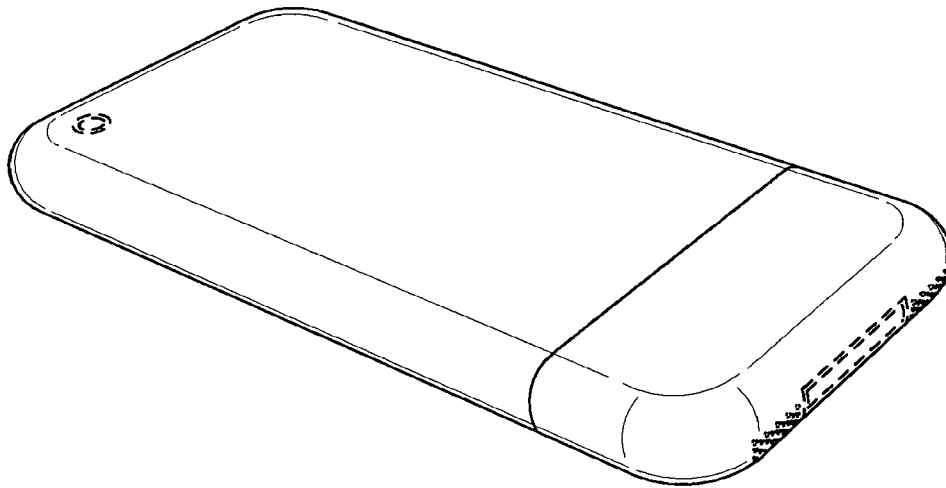
**FIG. 13**



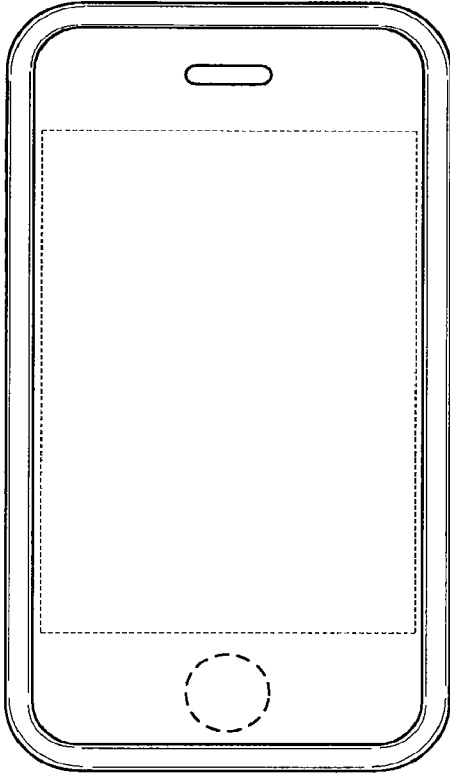
**FIG. 14**



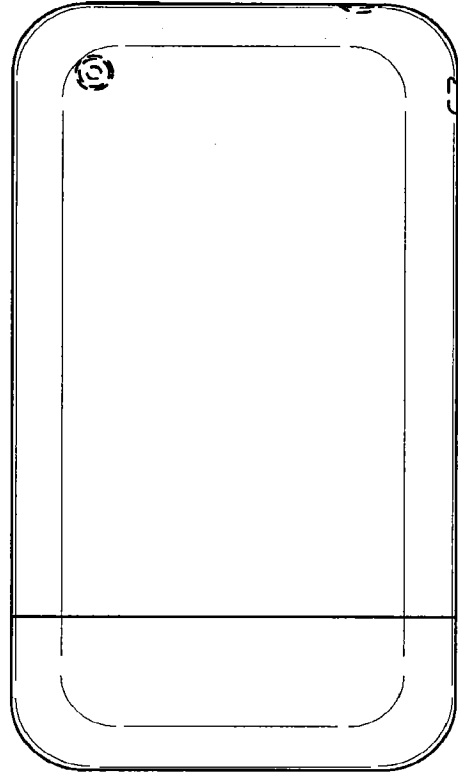
**FIG. 17**



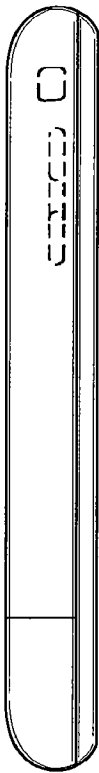
**FIG. 18**



**FIG. 19**



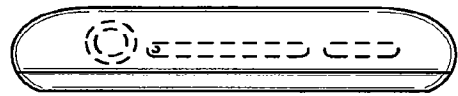
**FIG. 20**



**FIG. 23**



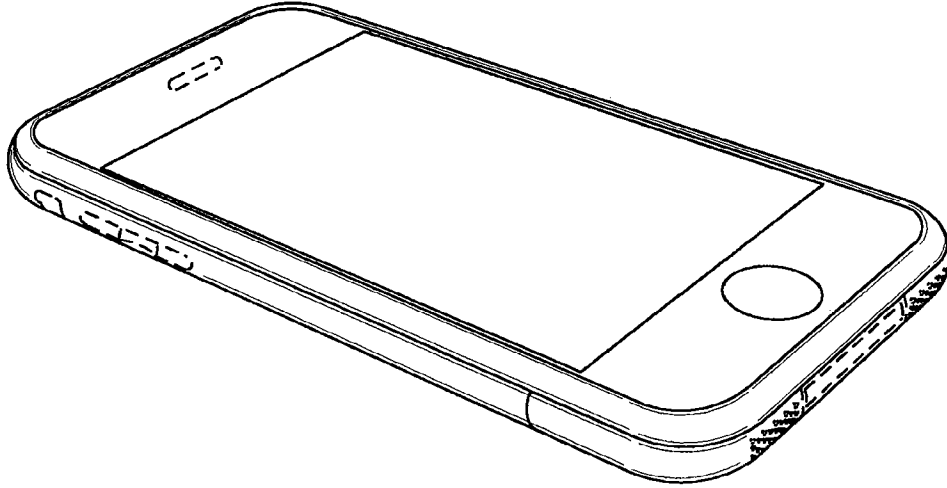
**FIG. 24**



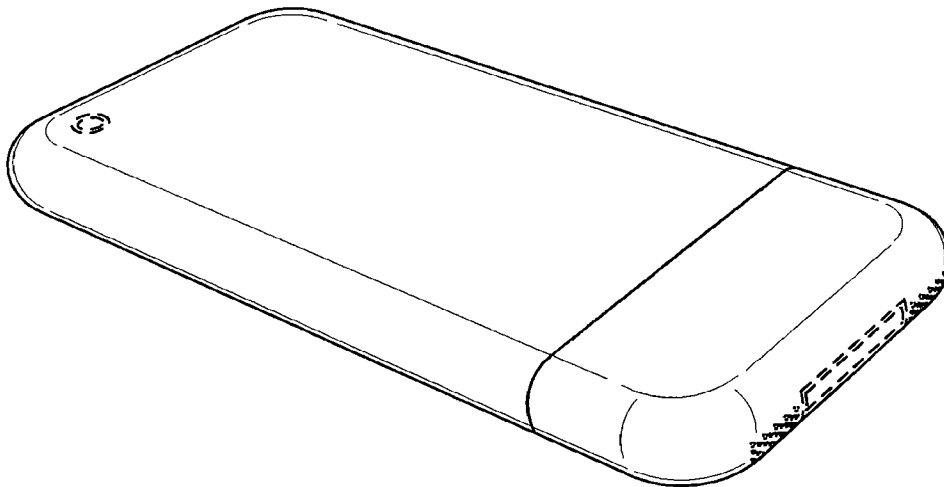
**FIG. 21**



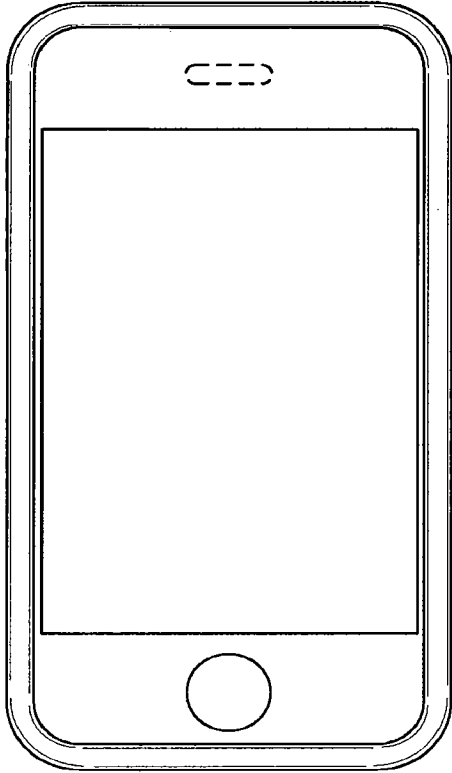
**FIG. 22**



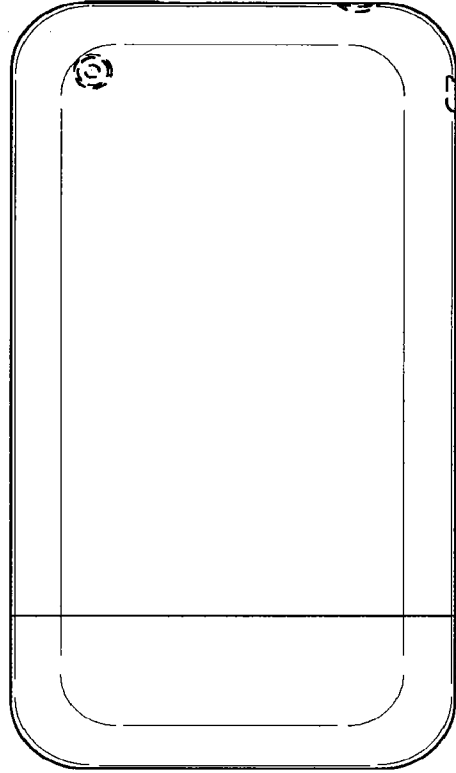
**FIG. 25**



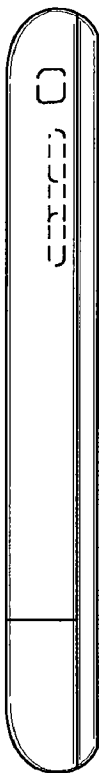
**FIG. 26**



**FIG. 27**



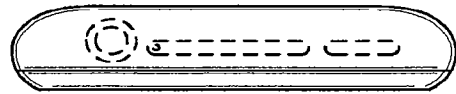
**FIG. 28**



**FIG. 31**



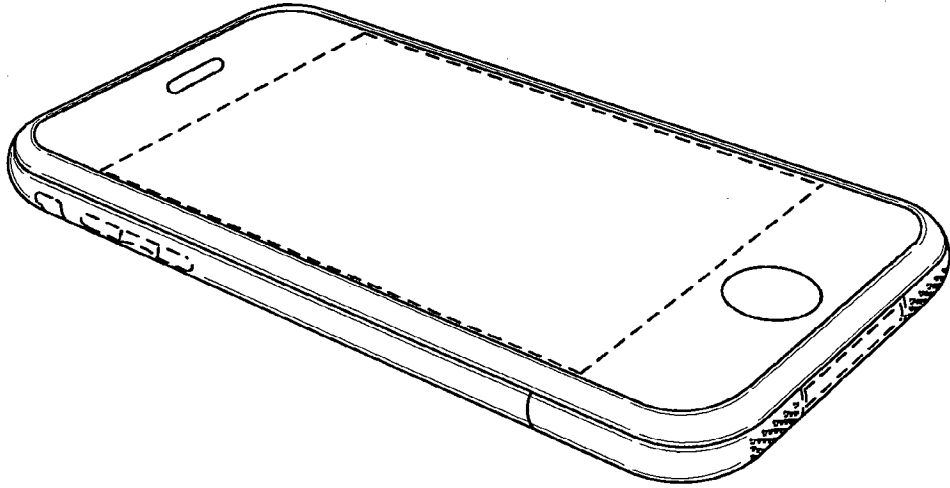
**FIG. 32**



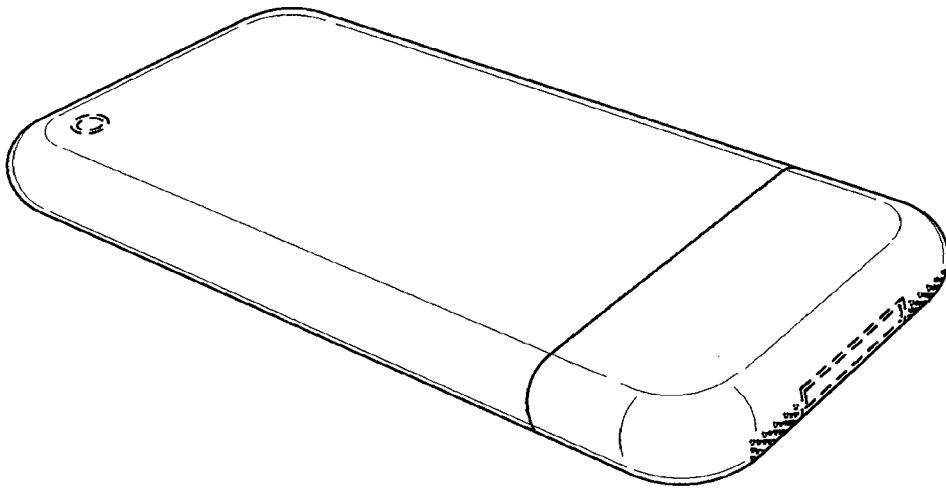
**FIG. 29**



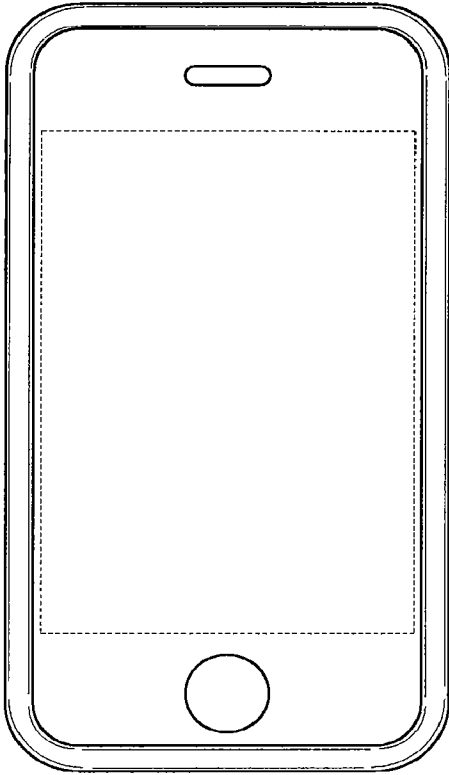
**FIG. 30**



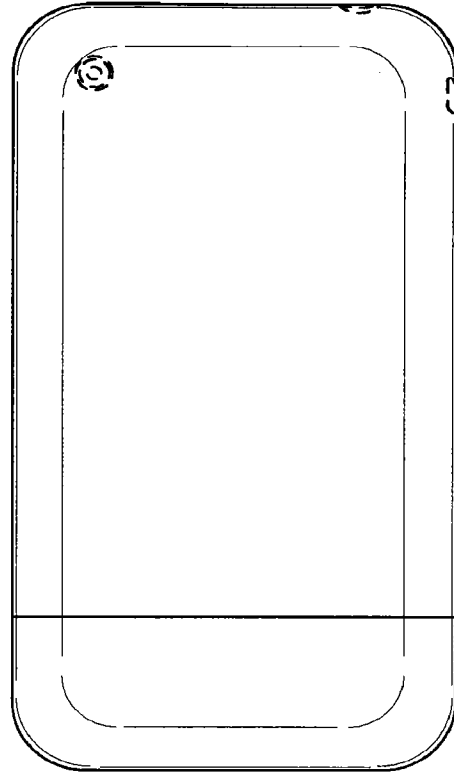
**FIG. 33**



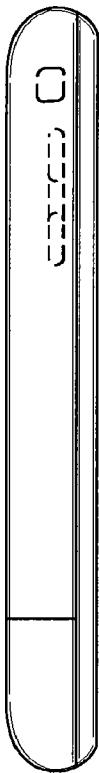
**FIG. 34**



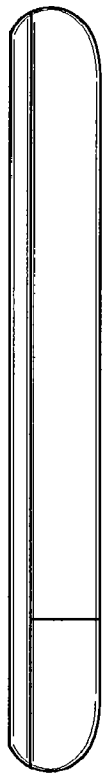
**FIG. 35**



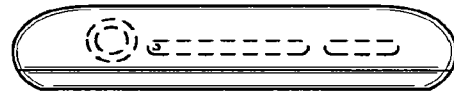
**FIG. 36**



**FIG. 39**



**FIG. 40**

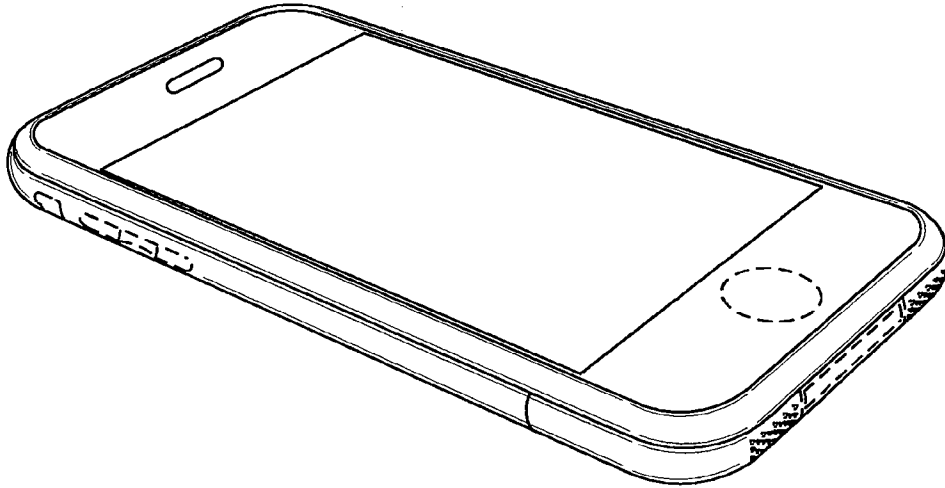


**FIG. 37**

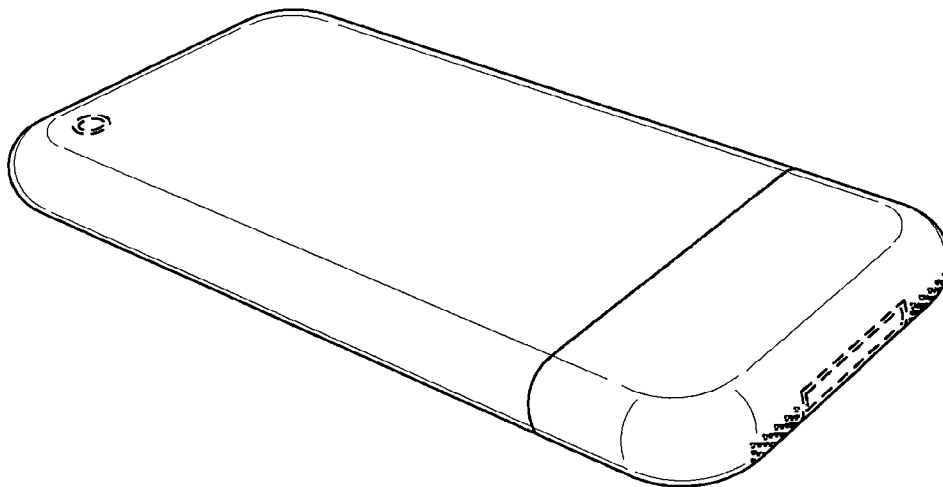


**FIG. 38**

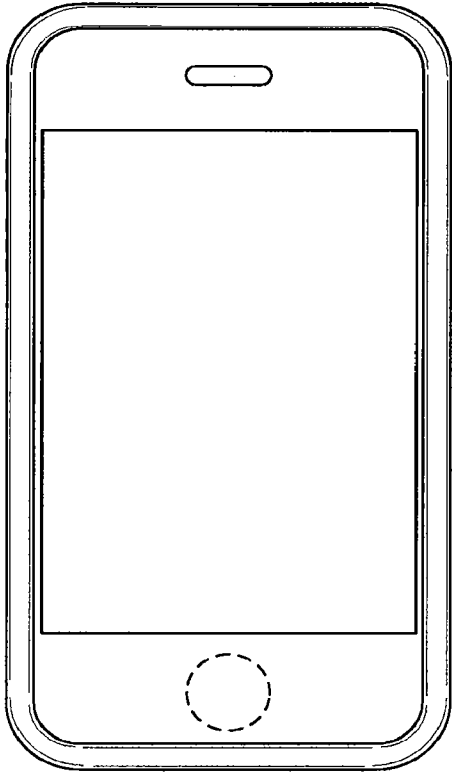




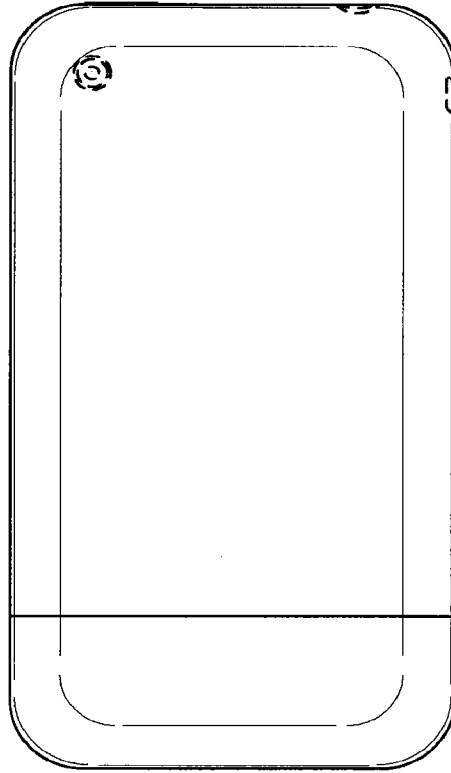
**FIG. 41**



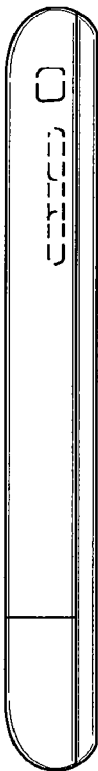
**FIG. 42**



**FIG. 43**



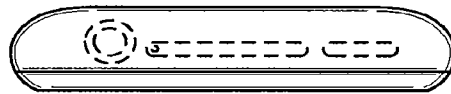
**FIG. 44**



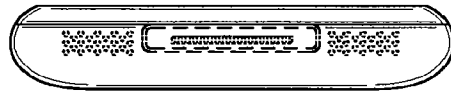
**FIG. 47**



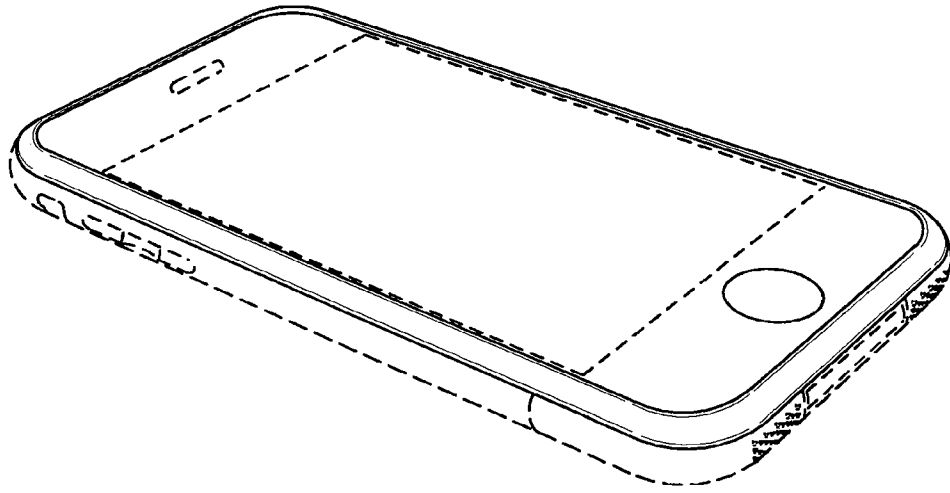
**FIG. 48**



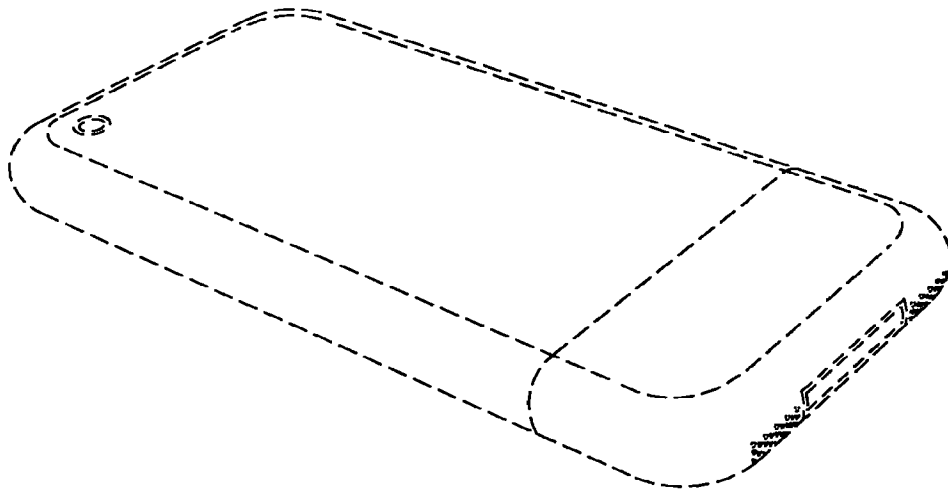
**FIG. 45**



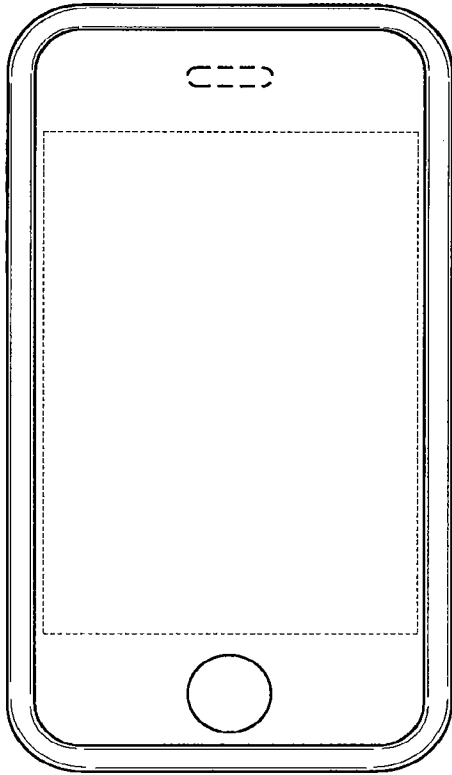
**FIG. 46**



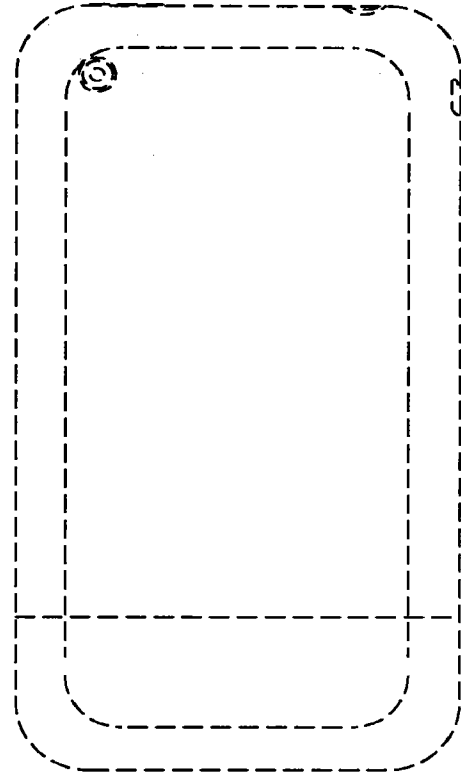
**FIG. 49**



**FIG. 50**



**FIG. 51**



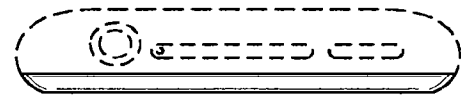
**FIG. 52**



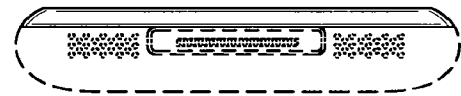
**FIG. 55**



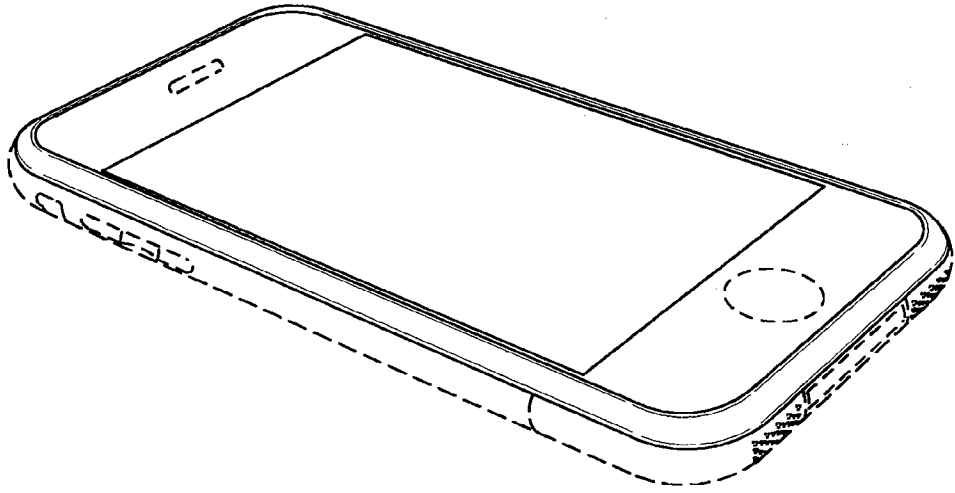
**FIG. 56**



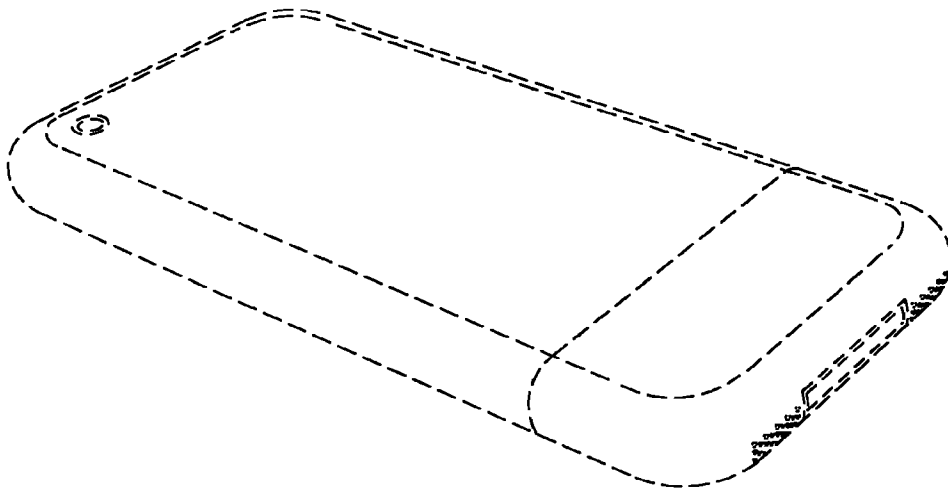
**FIG. 53**



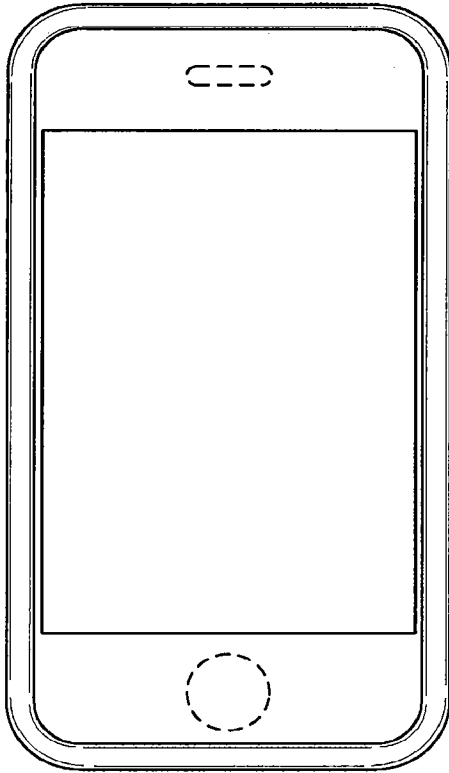
**FIG. 54**



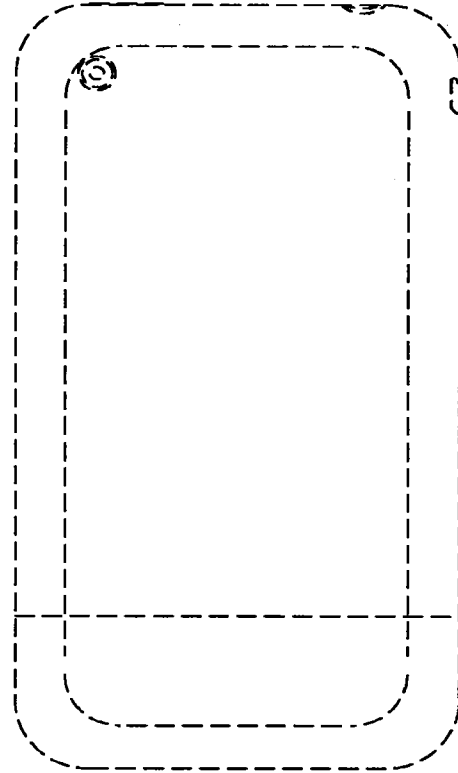
**FIG. 57**



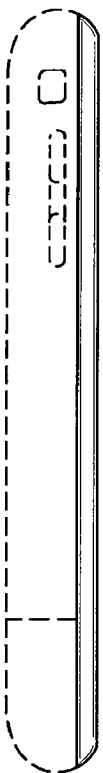
**FIG. 58**



**FIG. 59**



**FIG. 60**



**FIG. 63**



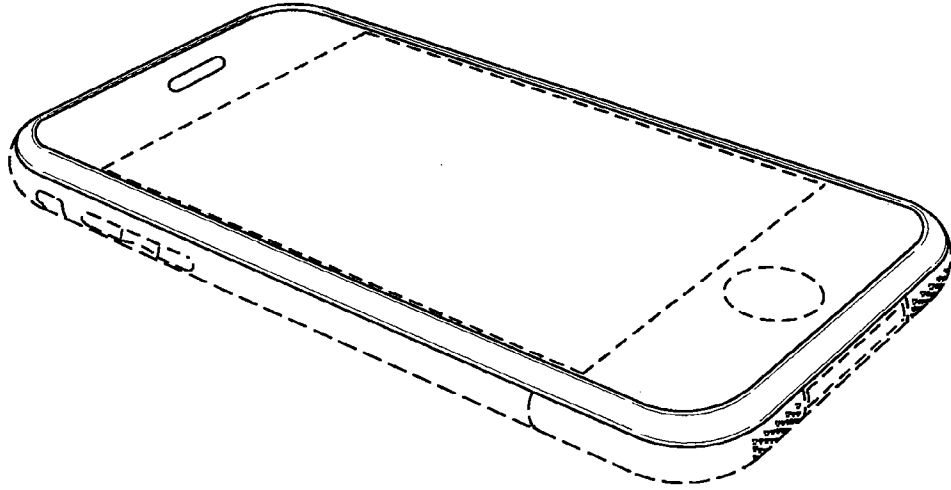
**FIG. 64**



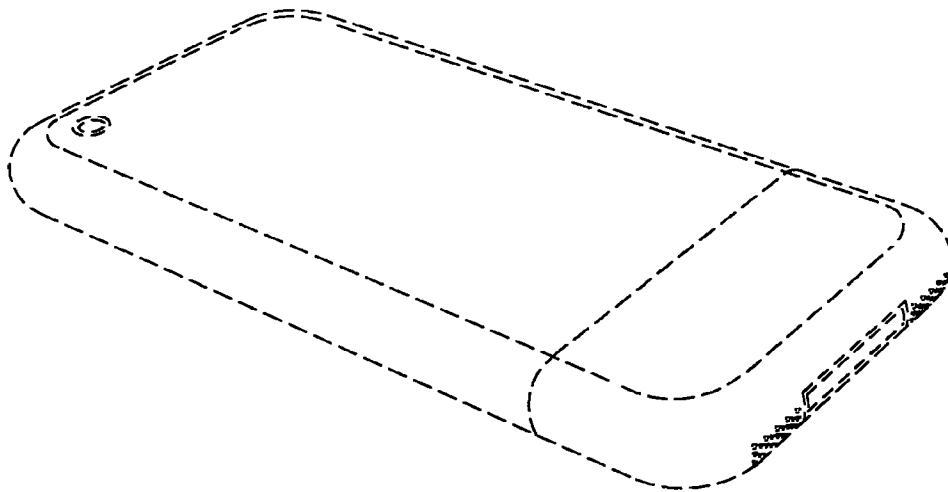
**FIG. 61**



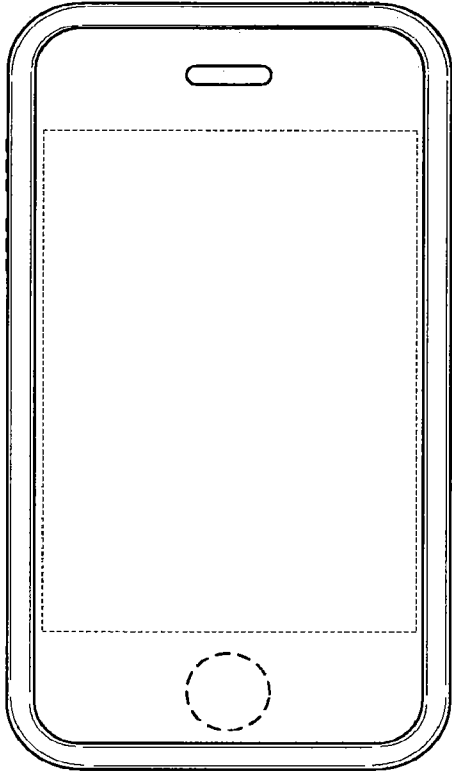
**FIG. 62**



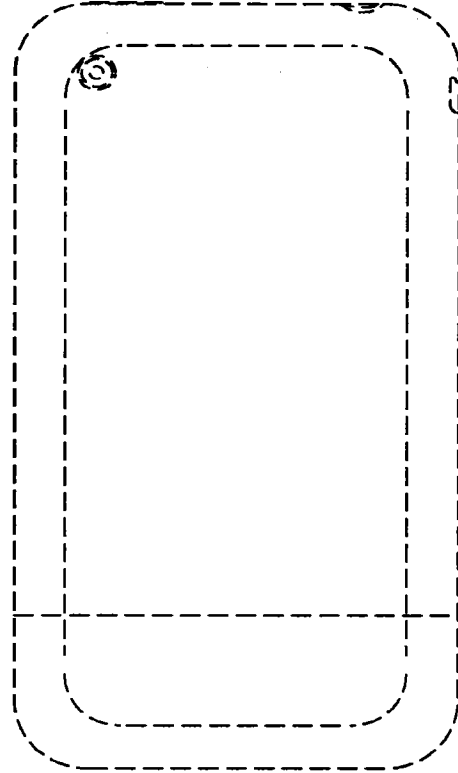
**FIG. 65**



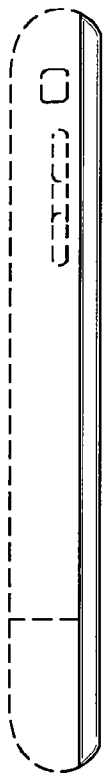
**FIG. 66**



**FIG. 67**



**FIG. 68**



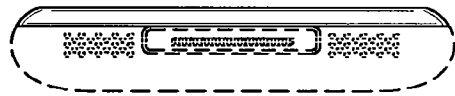
**FIG. 71**



**FIG. 72**

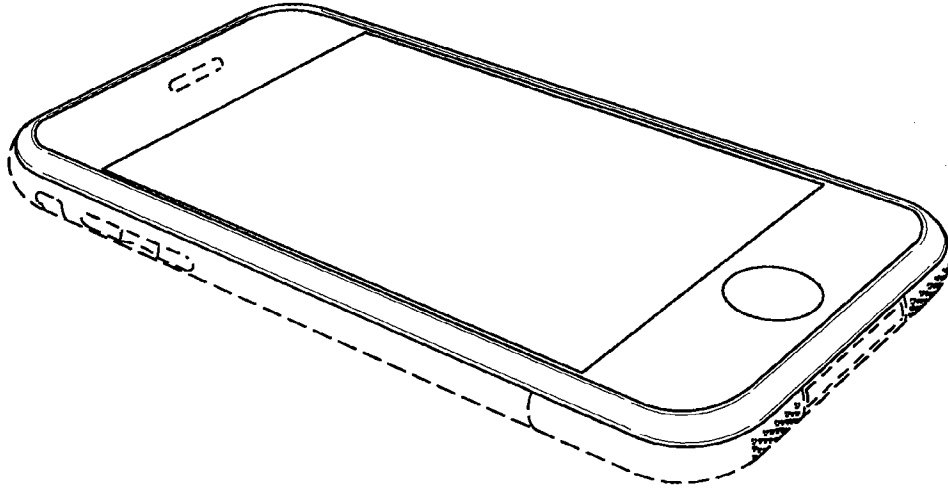


**FIG. 69**

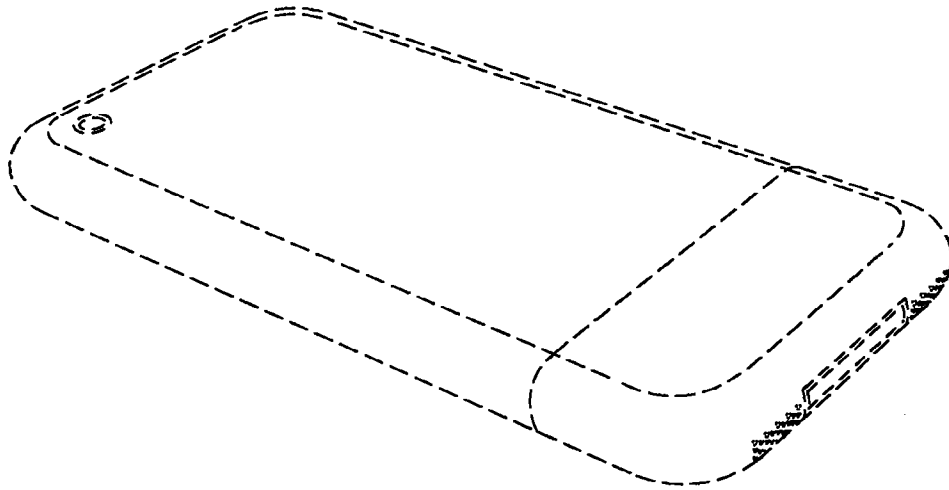


**FIG. 70**

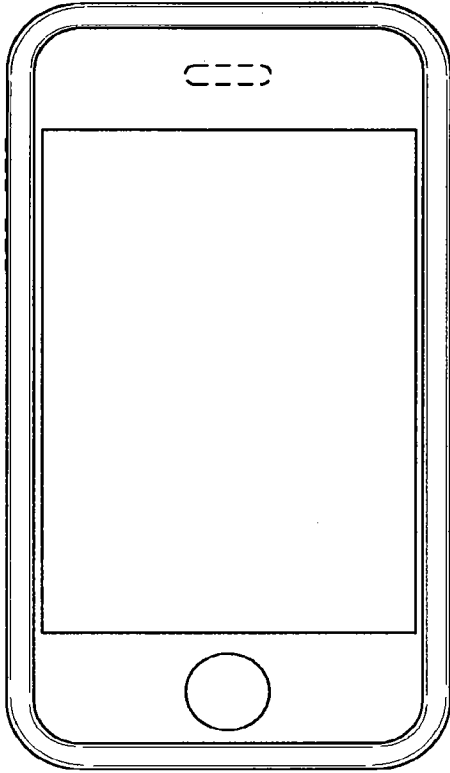




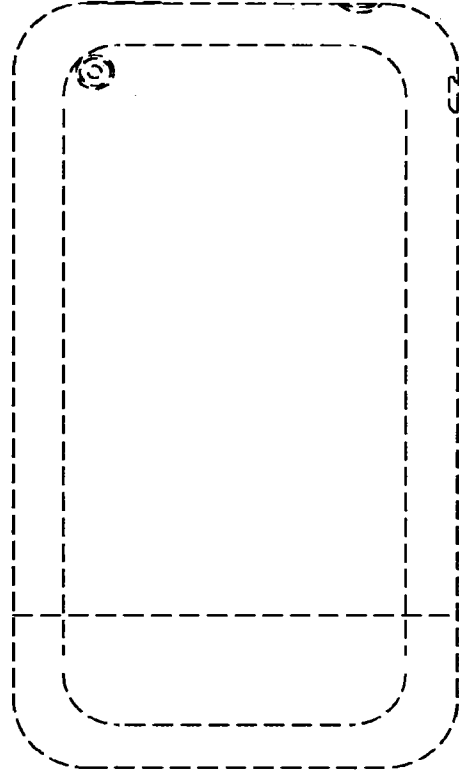
**FIG. 73**



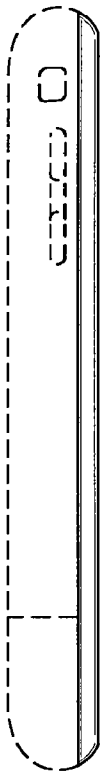
**FIG. 74**



**FIG. 75**



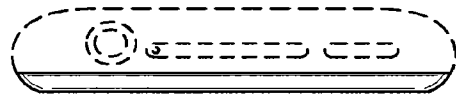
**FIG. 76**



**FIG. 79**



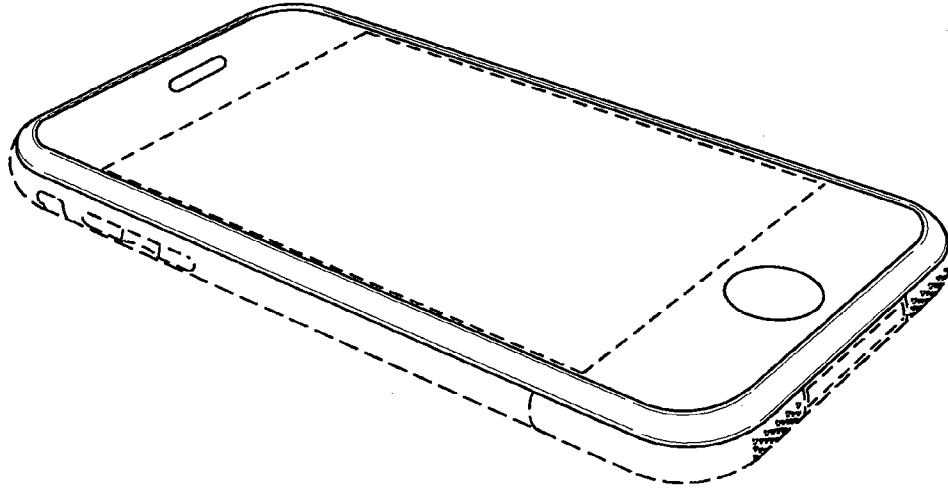
**FIG. 80**



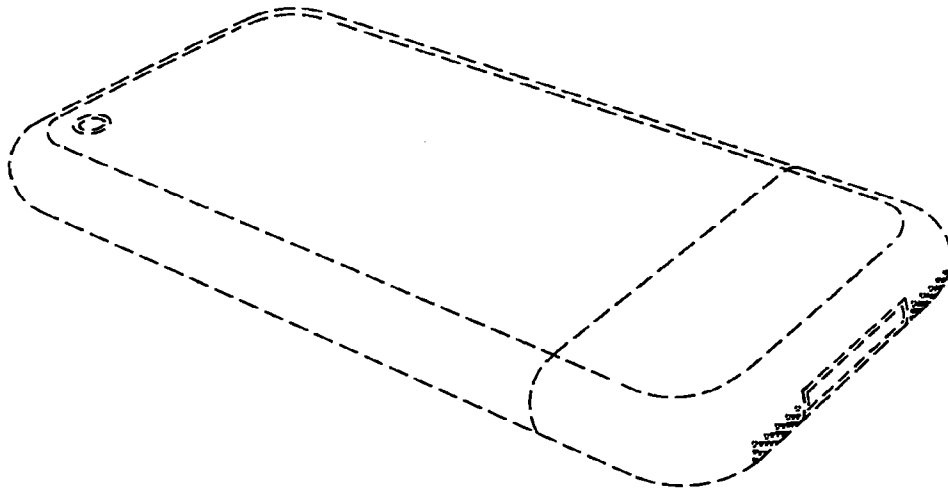
**FIG. 77**



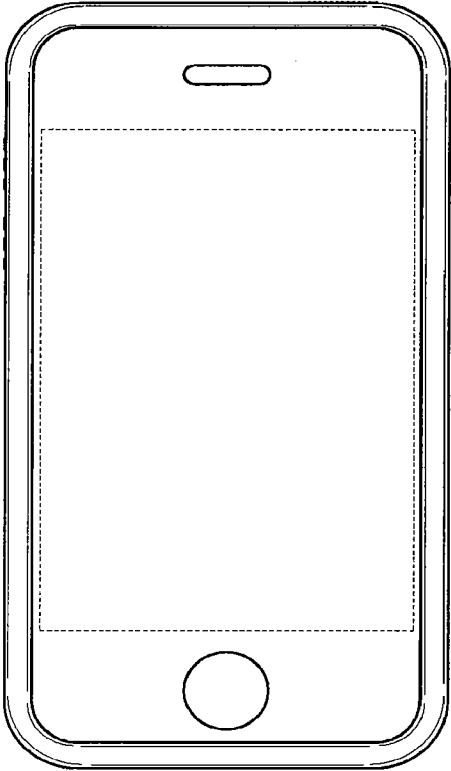
**FIG. 78**



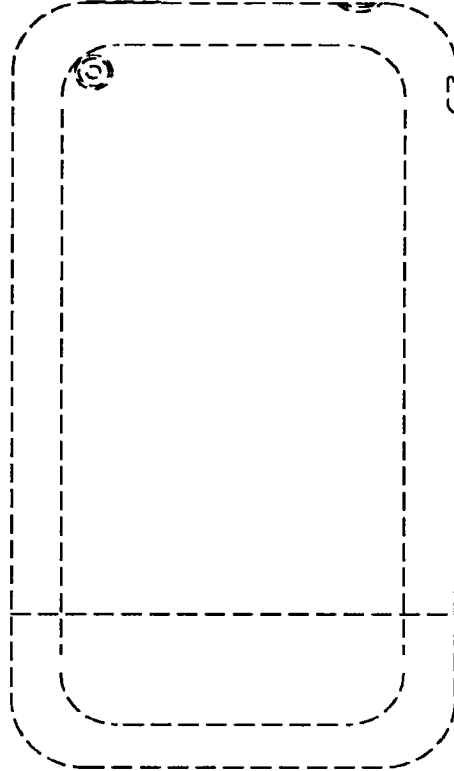
**FIG. 81**



**FIG. 82**



**FIG. 83**



**FIG. 84**



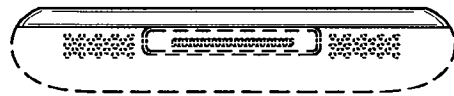
**FIG. 87**



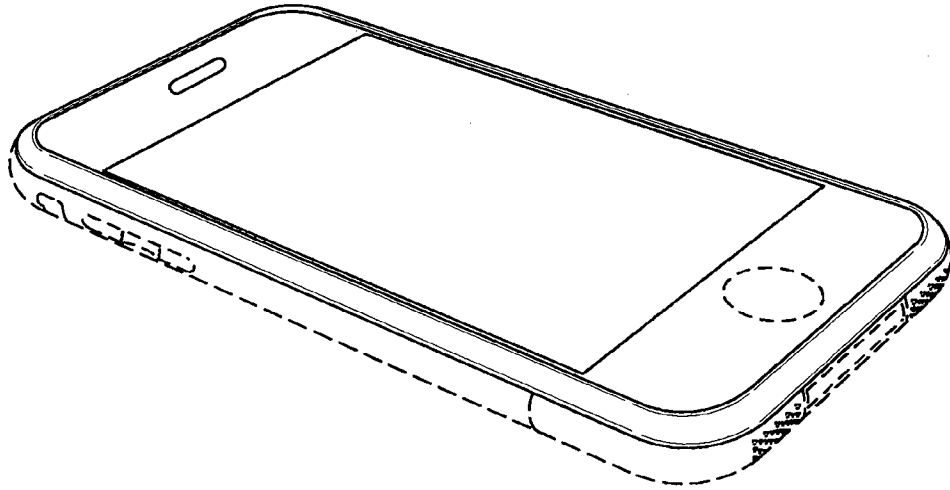
**FIG. 88**



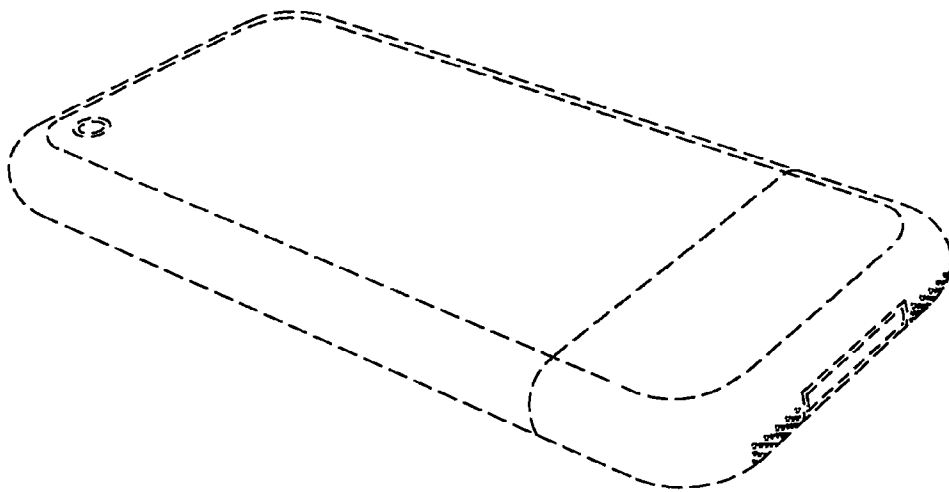
**FIG. 85**



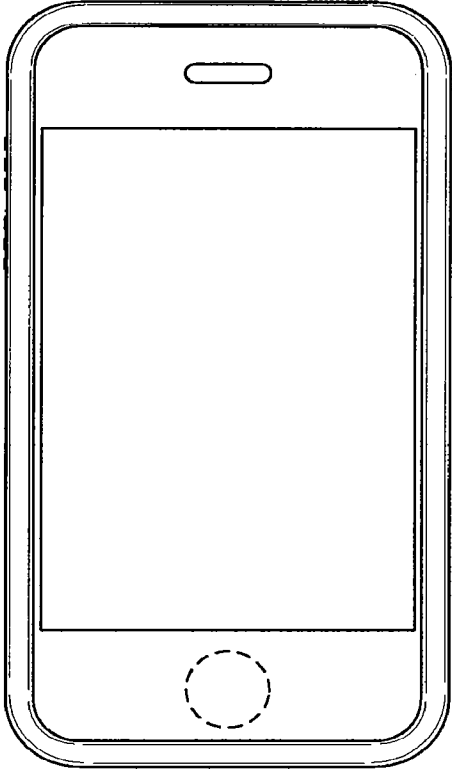
**FIG. 86**



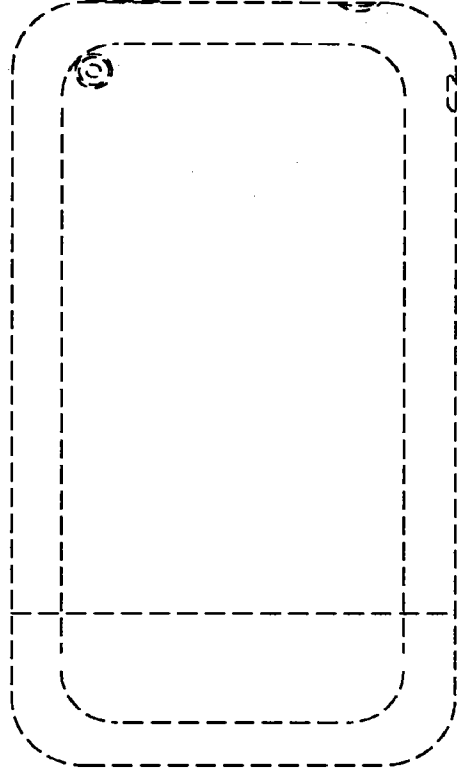
**FIG. 89**



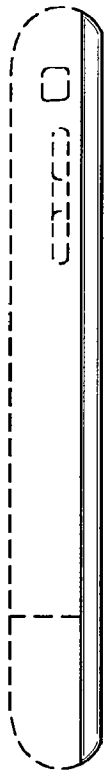
**FIG. 90**



**FIG. 91**



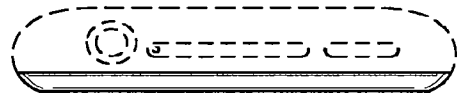
**FIG. 92**



**FIG. 95**



**FIG. 96**



**FIG. 93**



**FIG. 94**



Robert Greene Sterne  
Jorge A. Goldstein  
David K.S. Cornwell  
Robert W. Esmond  
Tracy-Gene G. Durkin  
Michele A. Cimbala  
Michael B. Ray  
Robert E. Sokohl  
Eric K. Steffe  
Michael Q. Lee  
John M. Covert  
Robert C. Millonig  
Donald J. Featherstone  
Timothy J. Shea, Jr  
Michael V. Messinger  
Judith U. Kim  
Jeffrey T. Helvey  
Eldora L. Ellison

Donald R. Banowitz  
Peter A. Jackman  
Brian J. Del Buono  
Mark Fox Evens  
Vincent L. Capuano  
Elizabeth J. Haanes  
Michael D. Specht  
Kevin W. McCabe  
Glenn J. Perry  
Edward W. Yee  
Grant E. Reed  
Virgil Lee Beaston  
Theodore A. Wood  
Joseph S. Ostroff  
Jason D. Eisenberg  
Tracy L. Muller  
Jon E. Wright  
LuAnne M. DeSantis

Ann E. Summerfield  
Helene C. Carlson  
Cynthia M. Bouchez  
Timothy A. Doyle  
Gaby L. Longsworth  
Lori A. Gordon  
Laura A. Vogel  
Bashir M.S. Ali  
Shannon A. Carroll  
Anbar F. Khai  
Michelle K. Holoubek  
Marsha A. Rose  
Scott A. Schaller  
Lei Zhou  
W. Blake Coblentz  
James J. Pohl  
John T. Haran  
Mark W. Rygiel

Michael R. Malek\*  
Carla Ji-Eun Kim  
Doyle A. Siever\*  
Ulrike Winkler Jenks  
Paul A. Calvo  
Robert A. Schwartzman  
C. Matthew Rozier\*  
Shameek Ghose  
Randall K. Baldwin  
Daniel J. Nevriy  
  
Registered Patent Agents•  
Karen R. Markowicz  
Matthew J. Dowd  
Mita Mukherjee  
Scott M. Woodhouse  
Peter A. Socarras  
Jeffrey K. Mills

Danielle L. Letting  
Lori Brandes  
Steven C. Oppenheimer  
Aaron S. Lukas  
Gaurav Asthana  
Robert E. Bakin  
Salvador M. Bezos  
  
Of Counsel  
Edward J. Kessler  
Kenneth C. Bass III  
Marvin C. Guthrie  
Christopher P. Wrist  
  
\*Admitted only in Maryland  
\*Admitted only in Virginia  
•Practice Limited to  
Federal Agencies

February 28, 2008

Commissioner for Patents  
PO Box 1450  
Alexandria, VA 22313-1450

**WRITER'S DIRECT NUMBER:**  
(202) 772-8660  
**INTERNET ADDRESS:**  
TDURKIN@SKGF.COM

**Mail Stop Amendment**

Re: U.S. Design Patent Application  
Application No. 29/282,833; Filed: July 30, 2007  
For: **Electronic Device**  
Inventors: **ANDRE et al.**  
Our Ref: 2607.0600001(P4984USC3)

Sir:

Transmitted herewith for appropriate action are the following documents:

1. First Supplemental Information Disclosure Statement;
2. Form PTO/SB/08a (1 sheet) listing 13 cited documents (US1-US12 and FP2);
3. Form PTO/SB/08b (2 sheets) listing 14 cited documents (NPL9-NPL22); and
4. A copy of the 1 cited document (FP2).

***The above-listed documents are filed electronically through EFS-Web.***

In the event that extensions of time are necessary to prevent abandonment of this patent application, then such extensions of time are hereby petitioned.

Commissioner for Patents  
February 28, 2008  
Page 2

The U.S. Patent and Trademark Office is hereby authorized to charge any fee deficiency, or credit any overpayment, to our Deposit Account No. 19-0036.

Respectfully submitted,

STERNE, KESSLER, GOLDSTEIN & FOX P.L.L.C.



Tracy-Gene G. Durkin  
Attorney for Applicants  
Registration No. 32,831

TGD/BKB:kim  
Enclosures  
785611\_1.DOC





Under the Paperwork Reduction Act of 1995, no persons are required to respond to a collection of information unless it contains a valid OMB control number.

Substitute for form 1449/PTO				<b>Complete if Known</b>	
<b>FIRST SUPPLEMENTAL INFORMATION DISCLOSURE STATEMENT BY APPLICANT</b> <i>(Use as many sheets as necessary)</i>				<i>Application Number</i>	29/282,833
				<i>Filing Date</i>	July 30, 2007
				<i>First Named Inventor</i>	Bartley K. ANDRE
				<i>Art Unit</i>	2916
				<i>Examiner Name</i>	Eland, Bridget L.
Sheet	1	of	2	<i>Attorney Docket Number</i>	2607.0600001(P4984USC3)

<b>NON PATENT LITERATURE DOCUMENTS</b>			
Examiner Initials*	Cite No. <sup>1</sup>	Include name of the author (in CAPITAL LETTERS), title of the article (when appropriate), title of the item (book, magazine, journal, serial, symposium, catalog, etc.), date, page(s), volume-issue number(s), publisher, city and/or country where published	T <sup>2</sup>
	NPL1	U.S. Appl. No. 29/270,887, Andre <i>et al.</i> , Electronic Device, filed 01-08-2007.	
	NPL2	U.S. Appl. No. 29/282,831, Andre <i>et al.</i> , Electronic Device, filed 07-30-2007.	
	NPL3	U.S. Appl. No. 29/282,832, Andre <i>et al.</i> , Electronic Device, filed 07-30-2007.	
	NPL4	U.S. Appl. No. 29/282,834, Andre <i>et al.</i> , Electronic Device, filed 07-30-2007.	
	NPL5	U.S. Appl. No. 29/284,187, Andre <i>et al.</i> , Electronic Device, filed 08-31-2007.	
	NPL6	U.S. Appl. No. 29/284,188, Andre <i>et al.</i> , Electronic Device, filed 08-31-2007.	
	NPL7	U.S. Appl. No. 29/284,269, Andre <i>et al.</i> , Electronic Device, filed 09-04-2007.	
	NPL8	U.S. Appl. No. 29/284,271, Andre <i>et al.</i> , Electronic Device, filed 09-04-2007.	
	NPL9	U.S. Appl. No. 29/284,272, Andre <i>et al.</i> , Electronic Device, filed 09-05-2007.	
	NPL10	U.S. Appl. No. 29/284,276, Andre <i>et al.</i> , Electronic Device, filed 09-05-2007.	

786417\_1.DOC

<b>Examiner Signature</b>		<b>Date Considered</b>	
-------------------------------	--	----------------------------	--

\*EXAMINER: Initial if reference considered, whether or not citation is in conformance with MPEP 609. Draw line through citation if not in conformance and not considered. Include copy of this form with next communication to applicant.

<sup>1</sup> Applicant's unique citation designation number (optional). <sup>2</sup> Applicant is to place a check mark here if English language Translation is attached.  
 This collection of information is required by 37 CFR 1.98. The information is required to obtain or retain a benefit by the public which is to file (and by the USPTO to process) an application. Confidentiality is governed by 35 U.S.C. 122 and 37 CFR 1.14. This collection is estimated to take 2 hours to complete, including gathering, preparing, and submitting the completed application form to the USPTO. Time will vary depending upon the individual case. Any comments on the amount of time you require to complete this form and/or suggestions for reducing this burden, should be sent to the Chief Information Officer, U.S. Patent and Trademark Office, P.O. Box 1450, Alexandria, VA 22313-1450. DO NOT SEND FEES OR COMPLETED FORMS TO THIS ADDRESS. SEND TO: Commissioner for Patents, P.O. Box 1450, Alexandria, VA 22313-1450.

If you need assistance in completing the form, call 1-800-PTO-9199 (1-800-786-9199) and select option 2.

Under the Paperwork Reduction Act of 1995, no persons are required to respond to a collection of information unless it contains a valid OMB control number.

Substitute for form 1449/PTO				<b>Complete if Known</b>	
				<i>Application Number</i>	29/282,833
<b>FIRST SUPPLEMENTAL INFORMATION DISCLOSURE STATEMENT BY APPLICANT</b> <i>(Use as many sheets as necessary)</i>				<i>Filing Date</i>	July 30, 2007
				<i>First Named Inventor</i>	Bartley K. ANDRE
				<i>Art Unit</i>	2916
				<i>Examiner Name</i>	Eland, Bridget L.
				<i>Attorney Docket Number</i>	2607.0600001(P4984USC3)
Sheet	2	of	2		

NON PATENT LITERATURE DOCUMENTS			
Examiner Initials*	Cite No. <sup>1</sup>	Include name of the author (in CAPITAL LETTERS), title of the article (when appropriate), title of the item (book, magazine, journal, serial, symposium, catalog, etc.), date, page(s), volume number, publisher, city and/or country where published	T <sup>2</sup>
	NPL11	U.S. Appl. No. 29/284,288, Andre <i>et al.</i> , Electronic Device, filed 09-05-2007.	
	NPL12	U.S. Appl. No. 29/284,308, Andre <i>et al.</i> , Electronic Device, filed 09-05-2007.	
	NPL13	U.S. Appl. No. 29/284,310, Andre <i>et al.</i> , Electronic Device, filed 09-05-2007.	
	NPL14	U.S. Appl. No. 29/284,312, Andre <i>et al.</i> , Electronic Device, filed 09-05-2007.	

Examiner Signature		Date Considered	
-----------------------	--	--------------------	--

\*EXAMINER: Initial if reference considered, whether or not citation is in conformance with MPEP 609. Draw line through citation if not in conformance and not considered. Include copy of this form with next communication to applicant.

<sup>1</sup> Applicant's unique citation designation number (optional). <sup>2</sup> Applicant is to place a check mark here if English language Translation is attached. This collection of information is required by 37 CFR 1.98. The information is required to obtain or retain a benefit by the public which is to file (and by the USPTO to process) an application. Confidentiality is governed by 35 U.S.C. 122 and 37 CFR 1.14. This collection is estimated to take 2 hours to complete, including gathering, preparing, and submitting the completed application form to the USPTO. Time will vary depending upon the individual case. Any comments on the amount of time you require to complete this form and/or suggestions for reducing this burden, should be sent to the Chief Information Officer, U.S. Patent and Trademark Office, P.O. Box 1450, Alexandria, VA 22313-1450. DO NOT SEND FEES OR COMPLETED FORMS TO THIS ADDRESS. SEND TO: Commissioner for Patents, P.O. Box 1450, Alexandria, VA 22313-1450.

If you need assistance in completing the form, call 1-800-PTO-9199 (1-800-786-9199) and select option 2.

## Electronic Acknowledgement Receipt

<b>EFS ID:</b>	2924441
<b>Application Number:</b>	29282833
<b>International Application Number:</b>	
<b>Confirmation Number:</b>	3463
<b>Title of Invention:</b>	Electronic Device
<b>First Named Inventor/Applicant Name:</b>	Bartley K. ANDRE
<b>Customer Number:</b>	63975
<b>Filer:</b>	Tracy-Gene G. Durkin/Kim Perry
<b>Filer Authorized By:</b>	Tracy-Gene G. Durkin
<b>Attorney Docket Number:</b>	2607.0600001(P4984USC3)/T
<b>Receipt Date:</b>	28-FEB-2008
<b>Filing Date:</b>	30-JUL-2007
<b>Time Stamp:</b>	15:45:46
<b>Application Type:</b>	Design

### Payment information:

Submitted with Payment	no
------------------------	----

### File Listing:

Document Number	Document Description	File Name	File Size(Bytes) /Message Digest	Multi Part /.zip	Pages (if appl.)
1		26070600001.pdf	392278 <small>044245375130513f4da7b83515e610a7672fa979</small>	yes	11

Multipart Description/PDF files in .zip description			
Document Description	Start	End	
Information Disclosure Statement Letter	1	2	
Information Disclosure Statement (IDS) Filed	3	11	

**Warnings:**

**Information:**

2	Foreign Reference	26070600001_FP2.pdf	120640	no	3
			56afbbb5b9abbd3222840f7437edba58199ed93		

**Warnings:**

**Information:**

<b>Total Files Size (in bytes):</b>	512918
-------------------------------------	--------

This Acknowledgement Receipt evidences receipt on the noted date by the USPTO of the indicated documents, characterized by the applicant, and including page counts, where applicable. It serves as evidence of receipt similar to a Post Card, as described in MPEP 503.

**New Applications Under 35 U.S.C. 111**

If a new application is being filed and the application includes the necessary components for a filing date (see 37 CFR 1.53(b)-(d) and MPEP 506), a Filing Receipt (37 CFR 1.54) will be issued in due course and the date shown on this Acknowledgement Receipt will establish the filing date of the application.

**National Stage of an International Application under 35 U.S.C. 371**

If a timely submission to enter the national stage of an international application is compliant with the conditions of 35 U.S.C. 371 and other applicable requirements a Form PCT/DO/EO/903 indicating acceptance of the application as a national stage submission under 35 U.S.C. 371 will be issued in addition to the Filing Receipt, in due course.

**New International Application Filed with the USPTO as a Receiving Office**

If a new international application is being filed and the international application includes the necessary components for an international filing date (see PCT Article 11 and MPEP 1810), a Notification of the International Application Number and of the International Filing Date (Form PCT/RO/105) will be issued in due course, subject to prescriptions concerning national security, and the date shown on this Acknowledgement Receipt will establish the international filing date of the application.



### RCD-ONLINE - Design consultation service - RCD information

---

**Design number :** 000569157-0005  
**Number of results :** 1 of 1

---

#### Design

**Filing date:** 01/08/2006  
**Registration date:** 01/08/2006  
**Publication date (A1):** 05/09/2006  
**Expiry date:** 01/08/2011  
**Locarno class-subclass:** 14.03  
**Verbal element:**  
**Status:** Registered and fully published (A1)  
**Language of filing:** English  
**Second language:** French

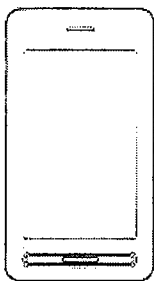
---

#### Representation

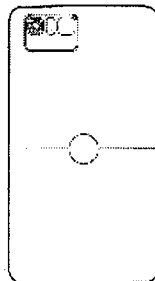
0005.1



0005.2



0005.3



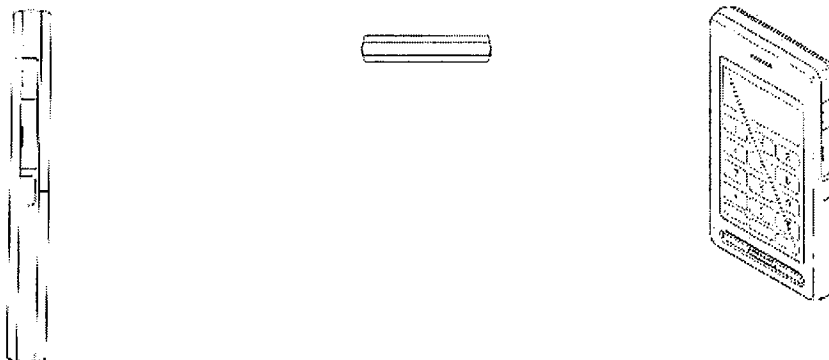
0005.4



0005.5

0005.6

0005.7



**Indication of the product**

**Indication of the product:** Mobile phones

**Owner**

**Name of the owner:** LG Electronics Inc.  
**ID number:** 144734  
**Natural or legal person:** Legal entity  
**Address:** 20, Yoido-dong, Yongdungpo-gu  
**Post code:** 150-721  
**Town:** Seoul  
**Country:** KOREA, REPUBLIC OF  
**Correspondence address:** LG Electronics Inc. 20, Yoido-dong, Yongdungpo-gu  
Seoul 150-721 REPÚBLICA DE COREA (LA)  
**Telephone:**  
**Fax:**  
**E-mail:**

**Representative**

**Name of the representative:** CABINET REGIMBEAU  
**ID number:** 10866  
**Natural or legal person:** Legal entity  
**Address:** 20, rue de Chazelles  
**Post code:** 75847  
**Town:** Paris Cédex 17  
**Country:** FRANCE  
**Correspondence address:** CABINET REGIMBEAU 20, rue de Chazelles F-75847  
Paris Cédex 17 FRANCIA  
**Telephone:** 00 33-144293500  
**Fax:** 00 33-144293599  
**E-mail:** paris@regimbeau.fr

**Designer**

No entry for design number: 000569157-0005

**Exhibition**

No entry for design number: 000569157-0005

**Priority**

**Country:** KOREA, REPUBLIC OF  
**Date of application:** 21/02/2006  
**Number of application:** 30-2006-0006542

---

**Publication**

**Bulletin number:** 2006/100  
**Date of publication:** 05/09/2006  
**Part:** A.1

**Bulletin number:** 2007/071  
**Date of publication:** 08/05/2007  
**Part:** A.3.2

**Bulletin number:** 2007/094  
**Date of publication:** 03/07/2007  
**Part:** B.2.2

**Bulletin number:** 2007/103  
**Date of publication:** 31/07/2007  
**Part:** B.2.2

**Bulletin number:** 2008/022  
**Date of publication:** 01/02/2008  
**Part:** B.2.2

---

**Renewals**

No entry for design number: 000569157-0005

Printed on: 23/02/2008 08:36 PM



IN THE UNITED STATES PATENT AND TRADEMARK OFFICE

In re application of:

ANDRE *et al.*

Appl. No.: 29/282,833

Filed: July 30, 2007

For: **Electronic Device**

Confirmation No.: 3463

Art Unit: 2916

Examiner: Eland, Bridget L.

Atty. Docket: 2607.0600001(P4984USC3)

**First Supplemental Information Disclosure Statement**

***Mail Stop Amendment***

Commissioner for Patents  
PO Box 1450  
Alexandria, VA 22313-1450

Sir:

Listed on accompanying IDS Forms are documents that may be considered material to the examination of this application, in compliance with the duty of disclosure requirements of 37 C.F.R. §§ 1.56, 1.97 and 1.98. The numbering on this First Supplemental Information Disclosure Statement is a continuation of the numbering in Applicants' Information Disclosure Statement filed on October 23, 2007 in connection with the above-captioned application.

Applicants have listed publication dates on the attached IDS Forms based on information presently available to the undersigned. However, the listed publication dates should not be construed as an admission that the information was actually published on the date indicated.

Applicants reserve the right to establish the patentability of the claimed invention over any of the information provided herewith, and/or to prove that this information may

not be prior art, and/or to prove that this information may not be enabling for the teachings purportedly offered.

This statement should not be construed as a representation that a search has been made, or that information more material to the examination of the present patent application does not exist. The Examiner is specifically requested not to rely solely on the material submitted herewith.

Applicants have checked the appropriate boxes below.

- 1. Statement under 37 C.F.R. 1.704(d). Each item of information contained in this Information Disclosure Statement was first cited in a communication from a foreign patent office in a counterpart application and this communication was not received by any individual designated in 37 C.F.R. § 1.56(c) more than thirty days prior to the filing of this information disclosure statement.
- 2. Filing under 37 C.F.R. § 1.97(b). This Information Disclosure Statement is being filed within three months of the date of filing of a national application other than a continued prosecution application (CPA), OR within three months of the date of entry of the national stage as set forth in 37 C.F.R. § 1.491 in an international application, OR before the mailing date of a first Office Action on the merits OR before the mailing of a first Office Action after the filing of a request for continued examination under 37 C.F.R. § 1.114. No statement or fee is required.
- 3. Filing under 37 C.F.R. § 1.97(c). This Information Disclosure Statement is being filed more than three months after the U.S. filing date AND after the mailing date

of the first Office Action on the merits, but before the mailing date of a Final Rejection, or Notice of Allowance, or an action that otherwise closes prosecution in the application.

- a. Statement under 37 C.F.R. § 1.97(e)(1). I hereby state that each item of information contained in this Information Disclosure Statement was first cited in any communication from a foreign patent office in a counterpart foreign application not more than three months prior to the filing of this Information Disclosure Statement. 37 C.F.R. § 1.97(e)(1).
- b. Statement under 37 C.F.R. § 1.97(e)(2). I hereby state that no item of information in this Information Disclosure Statement was cited in a communication from a foreign patent office in a counterpart foreign application and, to my knowledge after making reasonable inquiry, was known to any individual designated in 37 C.F.R. § 1.56(c) more than three months prior to the filing of this Information Disclosure Statement. 37 C.F.R. § 1.97(e)(2).
- c. Attached is our PTO-2038 Credit Card Payment Form in the amount of \$0.00 in payment of the fee under 37 C.F.R. § 1.17(p).
- 4. Filing under 37 C.F.R. § 1.97(d) This Information Disclosure Statement is being filed more than three months after the U.S. filing date and after the mailing date of a Final Rejection or Notice of Allowance, but before payment of the Issue Fee.

Enclosed find our PTO-2038 Credit Card Payment Form in the amount of \$0.00 in payment of the fee under 37 C.F.R. § 1.17(p); in addition:

- a. Statement under 37 C.F.R. § 1.97(e)(1). I hereby state that each item of information contained in this Information Disclosure Statement was first cited in any communication from a foreign patent office in a counterpart foreign application not more than three months prior to the filing of this Information Disclosure Statement. 37 C.F.R. § 1.97(e)(1).
- b. Statement under 37 C.F.R. § 1.97(e)(2). I hereby state that no item of information in this Information Disclosure Statement was cited in a communication from a foreign patent office in a counterpart foreign application and, to my knowledge after making reasonable inquiry, was known to any individual designated in 37 C.F.R. § 1.56(c) more than three months prior to the filing of this Information Disclosure Statement. 37 C.F.R. § 1.97(e)(2).
- 5. The document(s) was/were cited in a search report by a foreign patent office in a counterpart foreign application. Submission of an English language version of the search report that indicates the degree of relevance found by the foreign office is provided in satisfaction of the requirement for a concise explanation of relevance. 1138 OG 37, 38.
- 6. A concise explanation of the relevance of the non-English language document(s) appears below in accordance with 37 C.F.R. § 1.98(a)(3).

Atty. Dkt. No. 2607.0600001(P4984USC3)

7. Copies of document **FP2** is submitted. However, in accordance with 37 C.F.R. § 1.98(a)(2), no copies of U.S. patents and patent application publications cited on the attached IDS Forms are submitted. **NPL9-NPL22** are believed to be stored on the Image File Wrapper System. Thus, a copy of these documents are not submitted. MPEP 1406; 1287 O.G. 163 (Oct. 19, 2004).
8. Copies of the documents were cited by or submitted to the Office in an IDS that complies with 37 C.F.R. § 1.98(a)-(c) in Application No. \_\_\_\_\_, filed \_\_\_\_\_, which is relied upon for an earlier filing date under 35 U.S.C. § 120. Thus, copies of these documents are not attached. 37 C.F.R. § 1.98(d).
9. It is expected that the examiner will review the prosecution and cited art in the parent application no. 29/270,880; filed January 5, 2007 in accordance with MPEP 2001.06(b), and indicate in the next communication from the office that the art cited in the earlier prosecution history has been reviewed in connection with the present application.

It is respectfully requested that the Examiner initial and return a copy of the enclosed IDS Forms, and indicate in the official file wrapper of this patent application that the documents have been considered.

The U.S. Patent and Trademark Office is hereby authorized to charge any fee deficiency, or credit any overpayment, to our Deposit Account No. 19-0036.

Respectfully submitted,

STERNE, KESSLER, GOLDSTEIN & FOX P.L.L.C.



Tracy-Gene G. Durkin  
Attorney for Applicants  
Registration No. 32,831

Date: February 28, 2008

1100 New York Avenue, N.W.  
Washington, D.C. 20005-3934  
(202) 371-2600

785598\_1.DOC



UNITED STATES PATENT AND TRADEMARK OFFICE

UNITED STATES DEPARTMENT OF COMMERCE
United States Patent and Trademark Office
Address: COMMISSIONER FOR PATENTS
P.O. Box 1450
Alexandria, Virginia 22313-1450
www.uspto.gov

Table with 5 columns: APPLICATION NO., FILING DATE, FIRST NAMED INVENTOR, ATTORNEY DOCKET NO., CONFIRMATION NO.
29/282,833 07/30/2007 Bartley K. ANDRE 2607.0600001(P4984USC3)/T 3463

63975 7590 07/21/2008
STERNE KESSLER GOLDSTEIN & FOX P.L.L.C.
1100 NEW YORK AVENUE, N.W.
WASHINGTON, DC 20005

EXAMINER

ELAND, BRIDGET L

ART UNIT PAPER NUMBER

2916

MAIL DATE DELIVERY MODE

07/21/2008

PAPER

Please find below and/or attached an Office communication concerning this application or proceeding.

The time period for reply, if any, is set in the attached communication.

<b>Office Action Summary</b>	<b>Application No.</b> 29/282,833	<b>Applicant(s)</b> ANDRE ET AL.	
	<b>Examiner</b> BRIDGET L. ELAND	<b>Art Unit</b> 2916	

-- The MAILING DATE of this communication appears on the cover sheet with the correspondence address --

**Period for Reply**

A SHORTENED STATUTORY PERIOD FOR REPLY IS SET TO EXPIRE 1 MONTH(S) OR THIRTY (30) DAYS, WHICHEVER IS LONGER, FROM THE MAILING DATE OF THIS COMMUNICATION.

- Extensions of time may be available under the provisions of 37 CFR 1.136(a). In no event, however, may a reply be timely filed after SIX (6) MONTHS from the mailing date of this communication.
- If NO period for reply is specified above, the maximum statutory period will apply and will expire SIX (6) MONTHS from the mailing date of this communication.
- Failure to reply within the set or extended period for reply will, by statute, cause the application to become ABANDONED (35 U.S.C. § 133). Any reply received by the Office later than three months after the mailing date of this communication, even if timely filed, may reduce any earned patent term adjustment. See 37 CFR 1.704(b).

**Status**

- 1)  Responsive to communication(s) filed on \_\_\_\_.
- 2a)  This action is **FINAL**.                      2b)  This action is non-final.
- 3)  Since this application is in condition for allowance except for formal matters, prosecution as to the merits is closed in accordance with the practice under *Ex parte Quayle*, 1935 C.D. 11, 453 O.G. 213.

**Disposition of Claims**

- 4)  Claim(s) 1 is/are pending in the application.  
4a) Of the above claim(s) \_\_\_\_ is/are withdrawn from consideration.
- 5)  Claim(s) \_\_\_\_ is/are allowed.
- 6)  Claim(s) \_\_\_\_ is/are rejected.
- 7)  Claim(s) \_\_\_\_ is/are objected to.
- 8)  Claim(s) 1 are subject to restriction and/or election requirement.

**Application Papers**

- 9)  The specification is objected to by the Examiner.
- 10)  The drawing(s) filed on \_\_\_\_ is/are: a)  accepted or b)  objected to by the Examiner.  
Applicant may not request that any objection to the drawing(s) be held in abeyance. See 37 CFR 1.85(a).  
Replacement drawing sheet(s) including the correction is required if the drawing(s) is objected to. See 37 CFR 1.121(d).
- 11)  The oath or declaration is objected to by the Examiner. Note the attached Office Action or form PTO-152.

**Priority under 35 U.S.C. § 119**

- 12)  Acknowledgment is made of a claim for foreign priority under 35 U.S.C. § 119(a)-(d) or (f).  
a)  All    b)  Some \*    c)  None of:
1.  Certified copies of the priority documents have been received.
2.  Certified copies of the priority documents have been received in Application No. \_\_\_\_.
3.  Copies of the certified copies of the priority documents have been received in this National Stage application from the International Bureau (PCT Rule 17.2(a)).

\* See the attached detailed Office action for a list of the certified copies not received.

**Attachment(s)**

- |   |   |
|---|---|
| 1) <input checked="" type="checkbox"/> Notice of References Cited (PTO-892)   | 4) <input type="checkbox"/> Interview Summary (PTO-413)<br>Paper No(s)/Mail Date. ____. |
| 2) <input type="checkbox"/> Notice of Draftsperson's Patent Drawing Review (PTO-948)  | 5) <input type="checkbox"/> Notice of Informal Patent Application                       |
| 3) <input checked="" type="checkbox"/> Information Disclosure Statement(s) (PTO/SB/08)<br>Paper No(s)/Mail Date <u>10/23/2007 &amp; 2/28/2008</u> . | 6) <input type="checkbox"/> Other: ____.  |



## **DETAILED OFFICE ACTION**

In a telephone interview to allow for an oral election to the following restriction requirement on 5/27/2008, Tracy-Gene G. Durkin requested that a written restriction requirement be provided.

### **RESTRICTION REQUIREMENT**

This application discloses the following embodiments:

Embodiment 1: FIGS 1-8 drawn to a first electronic device with circular feature.

Embodiment 2: FIGS 9-16 drawn to a second electronic device with display feature.

Embodiment 3: FIGS 17-24 drawn to a third electronic device with oval feature.

Embodiment 4: FIGS 25-32 drawn to a fourth electronic device with display and circular features.

Embodiment 5: FIGS 33-40 drawn to a fifth electronic device with oval and circular features.

Embodiment 6: FIGS 41-48 drawn to a sixth electronic device with oval and display features.

Embodiment 7: FIGS 49-56 drawn to a first front panel with bevelled edge for an electronic device with circular feature.

Embodiment 8: FIGS 57-64 drawn to a first front panel with bevelled edge for an electronic device with display feature.

Embodiment 9: FIGS 65-72 drawn to a first front panel with bevelled edge for an electronic device with oval feature.

Embodiment 10: FIGS 73-80 drawn to a first front panel with bevelled edge for an electronic device with display and circular features.

Embodiment 11: FIGS 81-88 drawn to a first front panel with bevelled edge for an electronic device with oval and circular features.

Embodiment 12: FIGS 89-96 drawn to a first front panel with bevelled edge for an electronic device with oval and display features.

Art Unit: 2916

The above embodiments divide into the following patentably distinct groups of designs:

- Group I: Embodiment 1, 4, and 5
- Group II: Embodiment 2, 4, and 6
- Group III: Embodiment 3, 5, and 6
- Group IV: Embodiment 7, 10, and 11
- Group V: Embodiment 8, 10, and 12
- Group VI: Embodiment 9, 11, and 12

The designs as grouped are distinct from each other since under the law a design patent covers only the invention disclosed as an entirety, and does not extend to patentably distinct segregable parts; the only way to protect such segregable parts is to apply for separate patents. See *Ex parte Sanford*, 1914 CD 69; 204 OG 1346 (Comm'r Pat. 1914); and *Blumcraft of Pittsburgh v. Ladd*, 238 F. Supp. 648, 144 USPQ 562 (D.D.C. 1965). It is further noted that patentably distinct combination/subcombination subject matter must be supported by separate claims, whereas only a single claim is permissible in a design patent application. See *In re Rubinfeld*, 270 F.2d 391, 123 USPQ 210 (CCPA 1959).

The change in scope, from a complete electronic device to a beveled front panel creates a patentably distinct design. Furthermore, the differences between them are considered major and patentably distinguishing, or are not shown to be obvious modifications of one another. Therefore, the change in appearance by reducing certain design features to broken lines creates patentably distinct designs.

Because the designs are distinct for the reason(s) given above, and have acquired separate status in the art, restriction for examination purposes as indicated is proper (35 U.S.C. 121).

Restriction is required under 35 U.S.C. 121 to one of the patentably distinct groups of designs.

A reply to this requirement must include an election of a single group for prosecution on the merits, even if this requirement is traversed, 37 CFR 1.143. Any reply that does not include election of a single group will be held nonresponsive. Applicant is also requested to direct cancellation of all drawing figures and the corresponding descriptions which are directed to nonelected groups.

Should applicant traverse this requirement on the grounds that the groups are not patentably distinct, applicant should present evidence or identify such evidence now of record showing the groups to be obvious variations of one another. If the groups are determined not to be patentably distinct and they remain in this application, any rejection of one group over prior art will apply equally to all other groups. See *Ex parte Appeal No. 315-40*, 152 USPQ 71 (Bd. App. 1965). No argument asserting patentability based on the differences between the groups will be considered once the groups have been determined to comprise a single inventive concept.

Art Unit: 2916

In view of the above requirement, action on the merits is deferred pending compliance with the requirement in accordance with *Ex parte Heckman*, 135 USPQ 229 (P.O. Super. Exam. 1960).

A shortened statutory period of ONE MONTH or THIRTY DAYS, whichever is longer, from the mailing date of this letter is set for applicant to elect a single embodiment for prosecution on the merits.

The embodiments disclosed within the groups have overall appearances that are basically the same. Furthermore, the differences between them are considered minor and patentably indistinguishing, or are shown to be obvious in view of analogous prior art cited. Therefore, they are considered by the examiner to be obvious variations of one another within the group. These embodiments thus comprise a single inventive concept and are grouped together.

The common embodiments are included in more than a single group as they are patentably indistinct from the other embodiment(s) in those groups and to give applicant the broadest possible choices in his or her election. If one of the groups with a common embodiment is elected in this application, then applicant is advised that the common embodiment should not be included in any continuing application to avoid a rejection on the ground of double patenting under 35 U.S.C. 171 in the new application.

### **CONTACT INFORMATION**

Any inquiry concerning this communication or earlier communications from the examiner should be directed to BRIDGET L. ELAND whose telephone number is (571)272-4675. The examiner can normally be reached Monday - Friday from 7:30 AM to 4:30 PM EDT.

If attempts to reach the examiner by telephone are unsuccessful, the examiner's supervisor, Ian Simmons, can be reached on (571) 272-2658. The fax phone number for the organization where this application or proceeding is assigned is 571-273-8300.

Information regarding the status of an application may be obtained from the Patent Application Information Retrieval (PAIR) system. Status information for published applications may be obtained from either Private PAIR or Public PAIR. Status information for unpublished applications is available through Private PAIR only. For more information about the PAIR system, see <http://pair-direct.uspto.gov>. Should you have questions on access to the Private PAIR system, contact the Electronic Business Center (EBC) at 866-217-9197 (toll-free).

/Bridget L. Eland/  
Examiner, Art Unit 2916

<b>Notice of References Cited</b>	Application/Control No. 29/282,833	Applicant(s)/Patent Under Reexamination ANDRE ET AL.	
	Examiner BRIDGET L. ELAND	Art Unit 2916	Page 1 of 2

**U.S. PATENT DOCUMENTS**

*		Document Number Country Code-Number-Kind Code	Date MM-YYYY	Name	Classification
*	A	US-D420,354 S	02-2000	Morales, Domingo	D14/191
*	B	US-2004/0166907 A1	08-2004	Yajima, Takayuki	455/575.3
*	C	US-2004/0223004 A1	11-2004	Lincke et al.	345/649
*	D	US-D536,962 S	02-2007	Tanner, Roger Geoffrey	D9/424
*	E	US-D541,785 S	05-2007	Hwang et al.	D14/138
*	F	US-D554,098 S	10-2007	Lee, Young Keun	D14/138
*	G	US-7,303,424 B2	12-2007	Tu et al.	439/372
*	H	US-D558,758 S	01-2008	Andre et al.	D14/341
*	I	US-D560,683 S	01-2008	Lee, Johann	D14/496
*	J	US-D558,460 S	01-2008	Yu et al.	D6/308
*	K	US-D562,285 S	02-2008	Lim, Hwi Tae	D14/138
*	L	US-D561,782 S	02-2008	Kim, Yong Seock	D14/496
*	M	US-D563,929 S	03-2008	Park, Sang Min	D14/138

**FOREIGN PATENT DOCUMENTS**

*		Document Number Country Code-Number-Kind Code	Date MM-YYYY	Country	Name	Classification
	N					
	O					
	P					
	Q					
	R					
	S					
	T					

**NON-PATENT DOCUMENTS**

*		Include as applicable: Author, Title Date, Publisher, Edition or Volume, Pertinent Pages)
	U	Samsung F490, announced January 2008, [online], [retrieved on 01-18-08]. Retrieved from Internet ,<URL: <a href="http://www.gsmarena.com">http://www.gsmarena.com</a> >
	V	LG KF700, announced February 2008, [online], [retrieved on 03-21-08]. Retrieved from Internet ,<URL: <a href="http://www.gsmarena.com">http://www.gsmarena.com</a> >
	W	
	X	

\*A copy of this reference is not being furnished with this Office action. (See MPEP § 707.05(a).)  
Dates in MM-YYYY format are publication dates. Classifications may be US or foreign.

<b>Notice of References Cited</b>	Application/Control No. 29/282,833	Applicant(s)/Patent Under Reexamination ANDRE ET AL.	
	Examiner BRIDGET L. ELAND	Art Unit 2916	Page 2 of 2

**U.S. PATENT DOCUMENTS**

*	Document Number Country Code-Number-Kind Code	Date MM-YYYY	Name	Classification
*	A US-D563,432 S	03-2008	Kim, Hyoung Won	D14/496
	B US-			
	C US-			
	D US-			
	E US-			
	F US-			
	G US-			
	H US-			
	I US-			
	J US-			
	K US-			
	L US-			
	M US-			

**FOREIGN PATENT DOCUMENTS**

*	Document Number Country Code-Number-Kind Code	Date MM-YYYY	Country	Name	Classification
	N				
	O				
	P				
	Q				
	R				
	S				
	T				

**NON-PATENT DOCUMENTS**

*	Document Number Country Code-Number-Kind Code	Date MM-YYYY	Country	Name	Classification
		Include as applicable: Author, Title Date, Publisher, Edition or Volume, Pertinent Pages)			
	U				
	V				
	W				
	X				

\*A copy of this reference is not being furnished with this Office action. (See MPEP § 707.05(a).)  
Dates in MM-YYYY format are publication dates. Classifications may be US or foreign.

<b>Search Notes</b>  	<b>Application/Control No.</b>  29282833	<b>Applicant(s)/Patent Under Reexamination</b>  ANDRE ET AL.
	<b>Examiner</b>  BRIDGET L ELAND	<b>Art Unit</b>  2916

<b>SEARCHED</b>			
<b>Class</b>	<b>Subclass</b>	<b>Date</b>	<b>Examiner</b>
D14	137, 138, 147, 191, 218, 247-248, 341-347, 496	6/27/2008	BLE
D10	65, 78, 104	6/27/2008	BLE
D13	168	6/27/2008	BLE
D18	7	6/27/2008	BLE
455	556.1, 566, 575.1, 575.3	6/25/2008	BLE
345	169	6/25/2008	BLE

<b>SEARCH NOTES</b>		
<b>Search Notes</b>	<b>Date</b>	<b>Examiner</b>
East database used: US-PGPUB, USPAT	6/27/2008	BLE
Checked forward and backward in East on select cited references	6/4/2008	BLE
Inventor name search on prior patents and current applications	4/16/2008	BLE
Consulted D14 Primary Examiner Jeffery Asch	6/10/2008	BLE
Internet Search: <a href="http://www.gsmarena.com/">http://www.gsmarena.com/</a>	6/27/2008	BLE
WIPO Hauge Database: 14-03	6/27/2008	BLE

<b>INTERFERENCE SEARCH</b>			
<b>Class</b>	<b>Subclass</b>	<b>Date</b>	<b>Examiner</b>
D14	138	6/25/2008	BLE



Equivalent of Form PTO/SB/08b (01-08)

Approved for use through 01/31/2008. OMB 0651-0031  
U.S. Patent and Trademark Office; U.S. DEPARTMENT OF COMMERCE

Under the Paperwork Reduction Act of 1995, no persons are required to respond to a collection of information unless it contains a valid OMB control number.

Substitute for form 1449/PTO				<b>Complete if Known</b>	
<b>FIRST SUPPLEMENTAL INFORMATION DISCLOSURE STATEMENT BY APPLICANT</b> <i>(Use as many sheets as necessary)</i>				<i>Application Number</i>	29/282,833
				<i>Filing Date</i>	July 30, 2007
				<i>First Named Inventor</i>	Bartley K. ANDRE
				<i>Art Unit</i>	2916
				<i>Examiner Name</i>	Eland, Bridget L.
Sheet	1	of	2	<i>Attorney Docket Number</i>	2607.0600001(P4984USC3)

<b>NON PATENT LITERATURE DOCUMENTS</b>			
Examiner Initials*	Cite No. <sup>1</sup>	Include name of the author (in CAPITAL LETTERS), title of the article (when appropriate), title of the item (book, magazine, journal, serial, symposium, catalog, etc.), date, page(s), volume-issue number(s), publisher, city and/or country where published	T <sup>2</sup>
	NPL1	U.S. Appl. No. 29/270,887, Andre <i>et al.</i> , Electronic Device, filed 01-08-2007.	
	NPL2	U.S. Appl. No. 29/282,831, Andre <i>et al.</i> , Electronic Device, filed 07-30-2007.	
	NPL3	U.S. Appl. No. 29/282,832, Andre <i>et al.</i> , Electronic Device, filed 07-30-2007.	
	NPL4	U.S. Appl. No. 29/282,834, Andre <i>et al.</i> , Electronic Device, filed 07-30-2007.	
	NPL5	U.S. Appl. No. 29/284,187, Andre <i>et al.</i> , Electronic Device, filed 08-31-2007.	
	NPL6	U.S. Appl. No. 29/284,188, Andre <i>et al.</i> , Electronic Device, filed 08-31-2007.	
	NPL7	U.S. Appl. No. 29/284,269, Andre <i>et al.</i> , Electronic Device, filed 09-04-2007.	
	NPL8	U.S. Appl. No. 29/284,271, Andre <i>et al.</i> , Electronic Device, filed 09-04-2007.	
	NPL9	U.S. Appl. No. 29/284,272, Andre <i>et al.</i> , Electronic Device, filed 09-05-2007.	
	NPL10	U.S. Appl. No. 29/284,276, Andre <i>et al.</i> , Electronic Device, filed 09-05-2007.	

786417\_1.DOC

Examiner Signature		Date Considered	
--------------------	--	-----------------	--

\*EXAMINER: Initial if reference considered, whether or not citation is in conformance with MPEP 609. Draw line through citation if not in conformance and not considered. Include copy of this form with next communication to applicant.

<sup>1</sup> Applicant's unique citation designation number (optional). <sup>2</sup> Applicant is to place a check mark here if English language Translation is attached.

This collection of information is required by 37 CFR 1.98. The information is required to obtain or retain a benefit by the public which is to file (and by the USPTO to process) an application. Confidentiality is governed by 35 U.S.C. 122 and 37 CFR 1.14. This collection is estimated to take 2 hours to complete, including gathering, preparing, and submitting the completed application form to the USPTO. Time will vary depending upon the individual case. Any comments on the amount of time you require to complete this form and/or suggestions for reducing this burden, should be sent to the Chief Information Officer, U.S. Patent and Trademark Office, P.O. Box 1450, Alexandria, VA 22313-1450. DO NOT SEND FEES OR COMPLETED FORMS TO THIS ADDRESS. SEND TO: Commissioner for Patents, P.O. Box 1450, Alexandria, VA 22313-1450.

If you need assistance in completing the form call 1-800-PTO-9199 (1-800-786-9199) and select option 2.

ALL REFERENCES CONSIDERED EXCEPT WHERE LINED THROUGH. /BLE/

APLPROS0000010548







UNITED STATES PATENT AND TRADEMARK OFFICE

UNITED STATES DEPARTMENT OF COMMERCE  
 United States Patent and Trademark Office  
 Address: COMMISSIONER FOR PATENTS  
 P.O. Box 1450  
 Alexandria, Virginia 22313-1450  
 www.uspto.gov

BIB DATA SHEET

CONFIRMATION NO. 3463

SERIAL NUMBER	FILING or 371(c) DATE	CLASS	GROUP ART UNIT	ATTORNEY DOCKET NO.
29/282,833	07/30/2007	D14	2916 2607	7.0600001(P4984USC8)/T
	<b>RULE</b>			

**APPLICANTS**

Bartley K. ANDRE, Menlo Park, CA;  
 Daniel J. Coster, San Francisco, CA;  
 Daniele De Iuliis, San Francisco, CA;  
 Richard P. Howarth, San Francisco, CA;  
 Jonathan P. Ive, San Francisco, CA;  
 Steve Jobs, Palo Alto, CA;  
 Duncan Robert Kerr, San Francisco, CA;  
 Shin Nishibori, San Francisco, CA;  
 Matthew Dean Rohrbach, San Francisco, CA;  
 Douglas B. Satzger, Menlo Park, CA;  
 Calvin Q. Seid, Palo Alto, CA;  
 Christopher J. Stringer, Portola Valley, CA;  
 Eugene Antony Whang, San Francisco, CA;  
 Rico Zorkendorfer, San Francisco, CA;

**\*\* CONTINUING DATA \*\*\*\*\***

This application is a CON of 29/270,880 01/05/2007 PAT D,558,756

**\*\* FOREIGN APPLICATIONS \*\*\*\*\***

**\*\* IF REQUIRED, FOREIGN FILING LICENSE GRANTED \*\***

08/01/2007

Foreign Priority claimed <input type="checkbox"/> Yes <input checked="" type="checkbox"/> No	<input type="checkbox"/> Met after Allowance	<b>STATE OR COUNTRY</b>	<b>SHEETS DRAWINGS</b>	<b>TOTAL CLAIMS</b>	<b>INDEPENDENT CLAIMS</b>
35 USC 119(a-d) conditions met <input type="checkbox"/> Yes <input checked="" type="checkbox"/> No	Initials	CA	2	1	1
Verified and Acknowledged <u>/BRIDGET L ELAND/</u> Examiner's Signature					

**ADDRESS**

STERNE KESSLER GOLDSTEIN & FOX P.L.L.C.  
 1100 NEW YORK AVENUE, N.W.  
 WASHINGTON, DC 20005  
 UNITED STATES

**TITLE**

Electronic Device

<b>FILING FEE RECEIVED</b> 560	FEES: Authority has been given in Paper No. _____ to charge/credit DEPOSIT ACCOUNT No. _____ for following:	<input type="checkbox"/> All Fees
		<input type="checkbox"/> 1.16 Fees (Filing)
		<input type="checkbox"/> 1.17 Fees (Processing Ext. of time)
		<input type="checkbox"/> 1.18 Fees (Issue)
		<input type="checkbox"/> Other _____
		<input type="checkbox"/> Credit

## IN THE UNITED STATES PATENT AND TRADEMARK OFFICE

In re application of:

ANDRE *et al.*

Appl. No.: 29/282,833

Filed: July 30, 2007

For: **Electronic Device**

Confirmation No.: 3463

Art Unit: 2916

Examiner: Eland, Bridget L.

Atty. Docket: 2607.0600001(P4984USC3)

**Information Disclosure Statement*****Mail Stop Amendment***

Commissioner for Patents  
PO Box 1450  
Alexandria, VA 22313-1450

Sir:

Listed on accompanying IDS Forms are documents that may be considered material to the examination of this application, in compliance with the duty of disclosure requirements of 37 C.F.R. §§ 1.56, 1.97 and 1.98.

Applicants have listed publication dates on the attached IDS Forms based on information presently available to the undersigned. However, the listed publication dates should not be construed as an admission that the information was actually published on the date indicated.

Applicants reserve the right to establish the patentability of the claimed invention over any of the information provided herewith, and/or to prove that this information may not be prior art, and/or to prove that this information may not be enabling for the teachings purportedly offered.

This statement should not be construed as a representation that a search has been made, or that information more material to the examination of the present patent

ALL REFERENCES CONSIDERED EXCEPT WHERE LINED THROUGH. /BLE/

APLPROS0000010551

- 2 -

ANDRE *et al.*  
Appl. No. 29/282,833

application does not exist. The Examiner is specifically requested not to rely solely on the material submitted herewith.

Applicants have checked the appropriate boxes below.

1. Statement under 37 C.F.R. 1.704(d). Each item of information contained in this Information Disclosure Statement was first cited in a communication from a foreign patent office in a counterpart application and this communication was not received by any individual designated in 37 C.F.R. § 1.56(c) more than thirty days prior to the filing of this information disclosure statement.
2. Filing under 37 C.F.R. § 1.97(b). This Information Disclosure Statement is being filed within three months of the date of filing of a national application other than a continued prosecution application (CPA), OR within three months of the date of entry of the national stage as set forth in 37 C.F.R. § 1.491 in an international application, OR before the mailing date of a first Office Action on the merits OR before the mailing of a first Office Action after the filing of a request for continued examination under 37 C.F.R. § 1.114. No statement or fee is required.
3. Filing under 37 C.F.R. § 1.97(c). This Information Disclosure Statement is being filed more than three months after the U.S. filing date AND after the mailing date of the first Office Action on the merits, but before the mailing date of a Final Rejection, or Notice of Allowance, or an action that otherwise closes prosecution in the application.

Atty. Dkt. No. 2607.0600001(P4984USC3)

ALL REFERENCES CONSIDERED EXCEPT WHERE LINED THROUGH. /BLE/

APLPROS0000010552

- a. Statement under 37 C.F.R. § 1.97(e)(1). I hereby state that each item of information contained in this Information Disclosure Statement was first cited in any communication from a foreign patent office in a counterpart foreign application not more than three months prior to the filing of this Information Disclosure Statement. 37 C.F.R. § 1.97(e)(1).
- b. Statement under 37 C.F.R. § 1.97(e)(2). I hereby state that no item of information in this Information Disclosure Statement was cited in a communication from a foreign patent office in a counterpart foreign application and, to my knowledge after making reasonable inquiry, was known to any individual designated in 37 C.F.R. § 1.56(c) more than three months prior to the filing of this Information Disclosure Statement. 37 C.F.R. § 1.97(e)(2).
- c. Attached is our PTO-2038 Credit Card Payment Form in the amount of \$\_\_\_\_\_ in payment of the fee under 37 C.F.R. § 1.17(p).
4. Filing under 37 C.F.R. § 1.97(d) This Information Disclosure Statement is being filed more than three months after the U.S. filing date and after the mailing date of a Final Rejection or Notice of Allowance, but before payment of the Issue Fee. Enclosed find our PTO-2038 Credit Card Payment Form in the amount of \$\_\_\_\_\_ in payment of the fee under 37 C.F.R. § 1.17(p); in addition:

Atty. Dkt. No. 2607.0600001(P4984USC3)

ALL REFERENCES CONSIDERED EXCEPT WHERE LINED THROUGH. /BLE/

APLPROS0000010553

- 4 -

ANDRE *et al.*  
Appl. No. 29/282,833

- a. Statement under 37 C.F.R. § 1.97(e)(1). I hereby state that each item of information contained in this Information Disclosure Statement was first cited in any communication from a foreign patent office in a counterpart foreign application not more than three months prior to the filing of this Information Disclosure Statement. 37 C.F.R. § 1.97(e)(1).
- b. Statement under 37 C.F.R. § 1.97(e)(2). I hereby state that no item of information in this Information Disclosure Statement was cited in a communication from a foreign patent office in a counterpart foreign application and, to my knowledge after making reasonable inquiry, was known to any individual designated in 37 C.F.R. § 1.56(c) more than three months prior to the filing of this Information Disclosure Statement. 37 C.F.R. § 1.97(e)(2).
5. The document(s) was/were cited in a search report by a foreign patent office in a counterpart foreign application. Submission of an English language version of the search report that indicates the degree of relevance found by the foreign office is provided in satisfaction of the requirement for a concise explanation of relevance. 1138 OG 37, 38.
6. A concise explanation of the relevance of the non-English language document(s) appears below in accordance with 37 C.F.R. § 1.98(a)(3).

Atty. Dkt. No. 2607.0600001(P4984USC3)

ALL REFERENCES CONSIDERED EXCEPT WHERE LINED THROUGH. /BLE/

APLPROS0000010554

- 5 -

ANDRE *et al.*  
Appl. No. 29/282,833

7. Copies of documents **NPL1 - NPL6** are submitted. However, in accordance with 37 C.F.R. § 1.98(a)(2), no copies of U.S. patents and patent application publications cited on the attached IDS Forms are submitted.
8. Copies of the documents **FP1, NPL7** and **NPL8** were cited by or submitted to the Office in an IDS that complies with 37 C.F.R. § 1.98(a)-(c) in Application No.29/270,880, filed January 5, 2007, which is relied upon for an earlier filing date under 35 U.S.C. § 120. Thus, copies of these documents are not attached. 37 C.F.R. § 1.98(d).
9. It is expected that the examiner will review the prosecution and cited art in the parent application no(s). 29/270,880; filed January 5, 2007 in accordance with MPEP 2001.06(b), and indicate in the next communication from the office that the art cited in the earlier prosecution history has been reviewed in connection with the present application.

It is respectfully requested that the Examiner initial and return a copy of the enclosed IDS Forms, and indicate in the official file wrapper of this patent application that the documents have been considered.

Atty. Dkt. No. 2607.0600001(P4984USC3)

ALL REFERENCES CONSIDERED EXCEPT WHERE LINED THROUGH. /BLE/

APLPROS0000010555

- 6 -

ANDRE *et al.*  
Appl. No. 29/282,833

The U.S. Patent and Trademark Office is hereby authorized to charge any fee deficiency, or credit any overpayment, to our Deposit Account No. 19-0036.

Respectfully submitted,

STERNE, KESSLER, GOLDSTEIN & FOX P.L.L.C.



Tracy-Gene G. Durkin  
Attorney for Applicants  
Registration No. 32,831

Date: October 23, 2007

1100 New York Avenue, N.W.  
Washington, D.C. 20005-3934  
(202) 371-2600

736605\_1.DOC

Atty. Dkt. No. 2607.0600001(P4984USC3)

ALL REFERENCES CONSIDERED EXCEPT WHERE LINED THROUGH. /BLE/

APLPROS0000010556