

# **EXHIBIT B**

(12) **United States Patent**  
**Jobs et al.**

(10) **Patent No.:** **US 7,479,949 B2**  
 (45) **Date of Patent:** **\*Jan. 20, 2009**

(54) **TOUCH SCREEN DEVICE, METHOD, AND GRAPHICAL USER INTERFACE FOR DETERMINING COMMANDS BY APPLYING HEURISTICS**

(65) **Prior Publication Data**  
 US 2008/0174570 A1 Jul. 24, 2008

**Related U.S. Application Data**

(75) Inventors: **Steven P. Jobs**, Palo Alto, CA (US); **Scott Forstall**, Mountain View, CA (US); **Greg Christie**, San Jose, CA (US); **Stephen O. Lemay**, San Francisco, CA (US); **Scott Herz**, San Jose, CA (US); **Marcel van Os**, San Francisco, CA (US); **Bas Ording**, San Francisco, CA (US); **Gregory Novick**, Santa Clara, CA (US); **Wayne C. Westerman**, San Francisco, CA (US); **Imran Chaudhri**, San Francisco, CA (US); **Patrick Lee Coffman**, Menlo Park, CA (US); **Kenneth Kocienda**, Sunnyvale, CA (US); **Nitin K. Ganatra**, San Jose, CA (US); **Freddy Allen Anzures**, San Francisco, CA (US); **Jeremy A. Wyld**, San Jose, CA (US); **Jeffrey Bush**, San Jose, CA (US); **Michael Matas**, San Francisco, CA (US); **Paul D. Marcos**, Los Altos, CA (US); **Charles J. Pisula**, San Jose, CA (US); **Virgil Scott King**, Mountain View, CA (US); **Chris Blumenberg**, San Francisco, CA (US); **Francisco Ryan Tolmasky**, Cupertino, CA (US); **Richard Williamson**, Los Gatos, CA (US); **Andre M. J. Boule**, Sunnyvale, CA (US); **Henri C. Lamiroux**, San Carlos, CA (US)

(63) Continuation of application No. 11/850,635, filed on Sep. 5, 2007.  
 (60) Provisional application No. 60/937,993, filed on Jun. 29, 2007, provisional application No. 60/937,991, filed on Jun. 29, 2007, provisional application No. 60/879,469, filed on Jan. 8, 2007, provisional application No. 60/879,253, filed on Jan. 7, 2007, provisional application No. 60/824,769, filed on Sep. 6, 2006.

(51) **Int. Cl.**  
**G09G 5/00** (2006.01)  
**G06F 3/048** (2006.01)  
 (52) **U.S. Cl.** ..... **345/173; 345/169; 715/786; 715/784**  
 (58) **Field of Classification Search** ..... **345/156, 345/157, 173-181**  
 See application file for complete search history.

(56) **References Cited**

U.S. PATENT DOCUMENTS

5,528,260	A *	6/1996	Kent	345/684
5,655,094	A *	8/1997	Cline et al.	715/786
5,805,161	A *	9/1998	Tiphane	715/786
6,278,443	B1	8/2001	Amro et al.	345/173
6,466,203	B2	10/2002	Van Ee	345/173
6,559,869	B1 *	5/2003	Lui et al.	715/785
6,597,345	B2 *	7/2003	Hirshberg	345/168
6,657,615	B2	12/2003	Harada	345/173
6,683,628	B1 *	1/2004	Nakagawa et al.	715/799
6,690,387	B2	2/2004	Zimmerman et al.	345/684
7,088,344	B2	8/2006	Maewaza et al.	345/173
7,093,203	B2	8/2006	Mugura et al.	715/864
2002/0158838	A1	10/2002	Smith et al.	345/156
2003/0184593	A1	10/2003	Dunlop	345/810
2004/0012572	A1	1/2004	Sowden et al.	345/173
2004/0021676	A1	2/2004	Chen et al.	345/684
2004/0160420	A1	8/2004	Baharav	345/173
2005/0012723	A1	1/2005	Pallakoff	345/173
2005/0193351	A1	9/2005	Huoviala	715/840

(73) Assignee: **Apple Inc.**, Cupertino, CA (US)

(\* ) Notice: Subject to any disclaimer, the term of this patent is extended or adjusted under 35 U.S.C. 154(b) by 0 days.

This patent is subject to a terminal disclaimer.

(21) Appl. No.: **12/101,832**

(22) Filed: **Apr. 11, 2008**

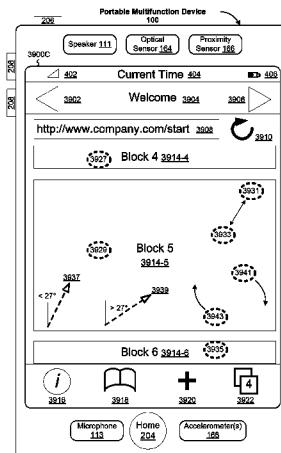

## US 7,479,949 B2

Page 2

2006/0001652	A1	1/2006	Chiu et al.	345/173
2006/0007178	A1	1/2006	Davis	345/173
2006/0022955	A1	2/2006	Kennedy	345/173
2006/0028428	A1	2/2006	Dai et al.	345/156
2006/0031786	A1	2/2006	Hillis et al.	715/863
2006/0044259	A1	3/2006	Hotelling et al.	345/156
2006/0049920	A1	3/2006	Sadler et al.	340/407.1
2006/0101354	A1	5/2006	Hashimoto et al.	715/863
2006/0132460	A1	6/2006	Kolmykov-Zotov et al.	345/173
2006/0164399	A1	7/2006	Cheston et al.	245/173
2006/0181519	A1	8/2006	Vernier et al.	345/173
2006/0253793	A1	11/2006	Zhai et al.	715/773
2006/0294472	A1	12/2006	Cheng et al.	715/771
2007/0040812	A1	2/2007	Tang et al.	345/173
2007/0061126	A1	3/2007	Russo et al.	713/24
2007/0118400	A1	5/2007	Morita et al.	705/2
2007/0120834	A1	5/2007	Boillot	345/173
2007/0130532	A1	6/2007	Fuller et al.	715/764
2007/0150826	A1	6/2007	Anzures et al.	715/772
2007/0152984	A1	7/2007	Ording et al.	345/173
2007/0177803	A1	8/2007	Elias et al.	382/188

## FOREIGN PATENT DOCUMENTS

EP	0 827 064	A2	3/1998
EP	0 827 094	A2	3/1998
EP	1 517 228	A2	3/2005
GB	2 347 200	A	8/2000
WO	WO 02/01338	A1	1/2002
WO	WO 2004/111816	A2	12/2004
WO	WO 2005/074268	A1	8/2005
WO	WO 2006/020305	A2	2/2006
WO	WO 2006/126055	A2	11/2006

## OTHER PUBLICATIONS

Examiner's Report on Australian Innovation Patent No. 2008100179, dated Apr. 30, 2008, which application claims priority to U.S. Appl. No. 60/824,726, the same priority application of the instant application.

Baguley, R., "Nokia Handhelds & Palmtops Internet Tablet 770, Nokia's Small, Svelte, Internet-Savvy PDA," Jan. 31, 2006, <http://www.pcworld.com/printable/article/id,124456/printable.html>.

Bordovsky et al., "Interpreting Commands from a Graphical User Interface," reproduced from International Technology Disclosures, vol. 9, No. 6, Jun. 25, 1991, 1 page.

Cheng et al., "Navigation Control and Gesture Recognition Input Device for Small, Portable User Interfaces," Synaptics Inc. of San Jose, California, pp. 1-13, 2004.

Computergram International, "Next-Generation Sharp Organiser to carry Pen Interface," No. 1955, Jul. 2, 1992.

Electronic Engineering Times, "Screen Can Tell Finger From Stylus," No. 858, Jul. 24, 1995, p. 67.

Gillespie, D., "Novel Touch Screens for Hand-Held Devices," Information Display, vol. 18, No. 2, Feb. 2002, 5 pages.

Hoover, J.N., "Computer GUI Revolution Continues with Microsoft Surface's Touch Screen, Object Recognition," Information Week, May 30, 2007, <http://www.informationweek.com/story/showArticle.jhtml?articleID=199703468>.

IBM, "Method to Disable and Enable a Touch Pad Pointing Device or Tablet Input Device Using Gestures," Jun. 11, 2002, pp. 1-3.

Johnson, R.C., "Gestures Redefine Computer Interface," Electronic Engineering Times, No. 924, p. 42(1), Oct. 21, 1996.

Korpela, J., "Using Inline Frames (iframe elements) to Embed Documents into HTML Documents," (Online), Sep. 25, 2006, <http://web.archive.org/web/20060925113551/http://www.cs.tut.fi/~jkorpela/html/iframe.html>.

Narayanaswamy, et al., "User Interface for a PCS Smart Phone," Multimedia Computing and Systems, IEEE Conference 1999, Published Jun. 7-11, 1999, vol. 1, pp. 777-781.

Poon et al., "Gestural User Interface Technique for Controlling the Playback of Sequential Media," Xerox Disclosure Journal, vol. 19, No. 2, Mar./Apr. 1994, pp. 187-190.

PR Newswire, "FingerWorks Announces a Gestue Keyboard for Apple PowerBooks," Jan. 27, 2004, 2 pages.

PR Newswire, "FingerWorks Announces the ZeroForce iGesture Pad," Feb. 18, 2003, 2 pages.

International Search Report and Written Opinion for International Application PCT/US2007/088885, mailed Apr. 24, 2008.

Examiner's Report on Australian Innovation Patent No. 2008100179 dated Apr. 30, 2008.

"Sprint Power Vision Smart Device Treo™ 700p by Palm," Sprint Nextel, 432 pages, 2006.

"Google Maps API—Google Code," Google Inc., <http://www.google.com/apis/maps>, 1 page, printed Apr. 10, 2008.

\* cited by examiner

Primary Examiner—Duc Q Dinh

(74) Attorney, Agent, or Firm—Morgan, Lewis & Bockius LLP

(57)

## ABSTRACT

A computer-implemented method for use in conjunction with a computing device with a touch screen display comprises: detecting one or more finger contacts with the touch screen display, applying one or more heuristics to the one or more finger contacts to determine a command for the device, and processing the command. The one or more heuristics comprise: a heuristic for determining that the one or more finger contacts correspond to a one-dimensional vertical screen scrolling command, a heuristic for determining that the one or more finger contacts correspond to a two-dimensional screen translation command, and a heuristic for determining that the one or more finger contacts correspond to a command to transition from displaying a respective item in a set of items to displaying a next item in the set of items.

20 Claims, 293 Drawing Sheets

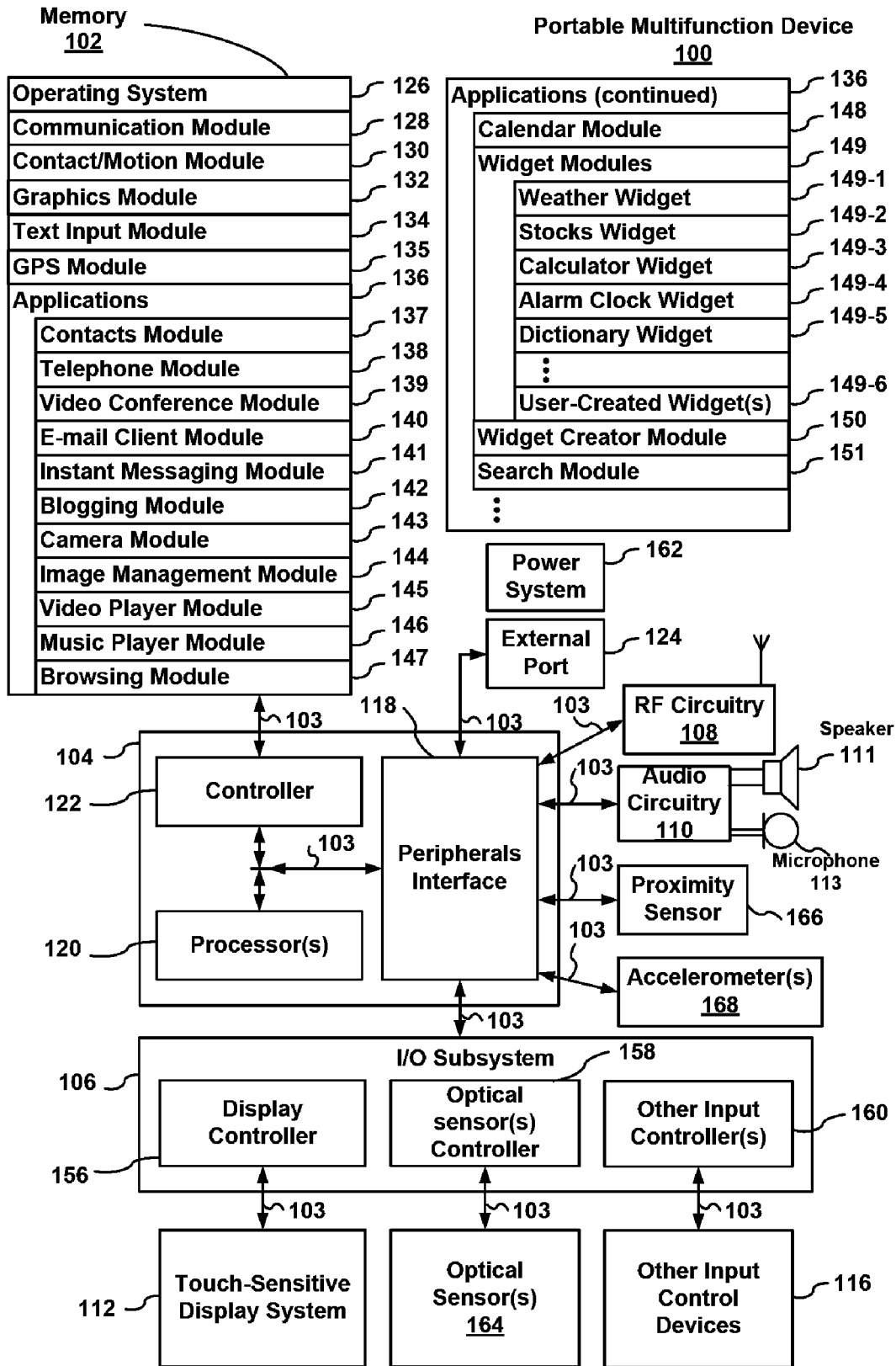

Figure 1A

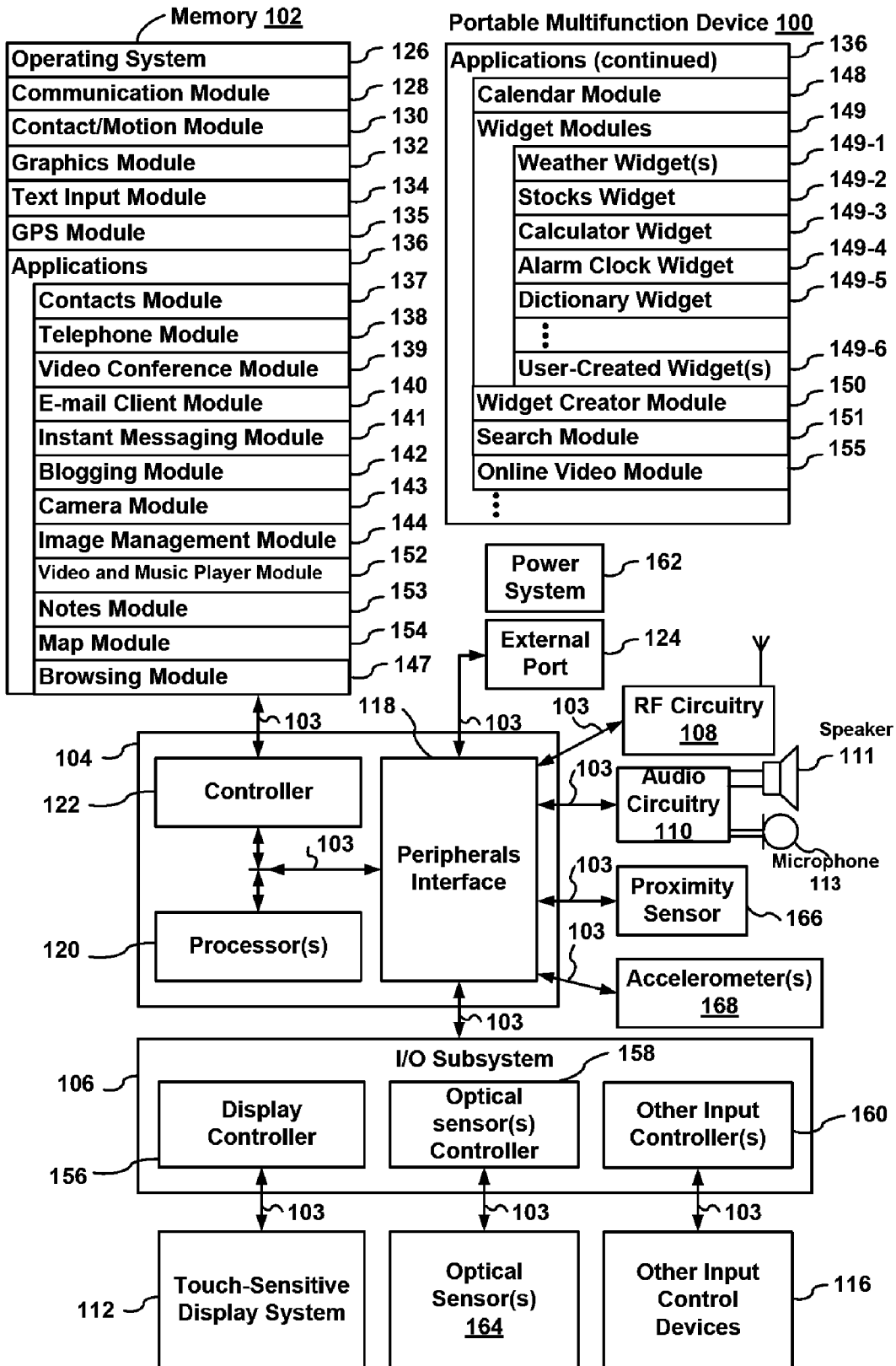

Figure 1B

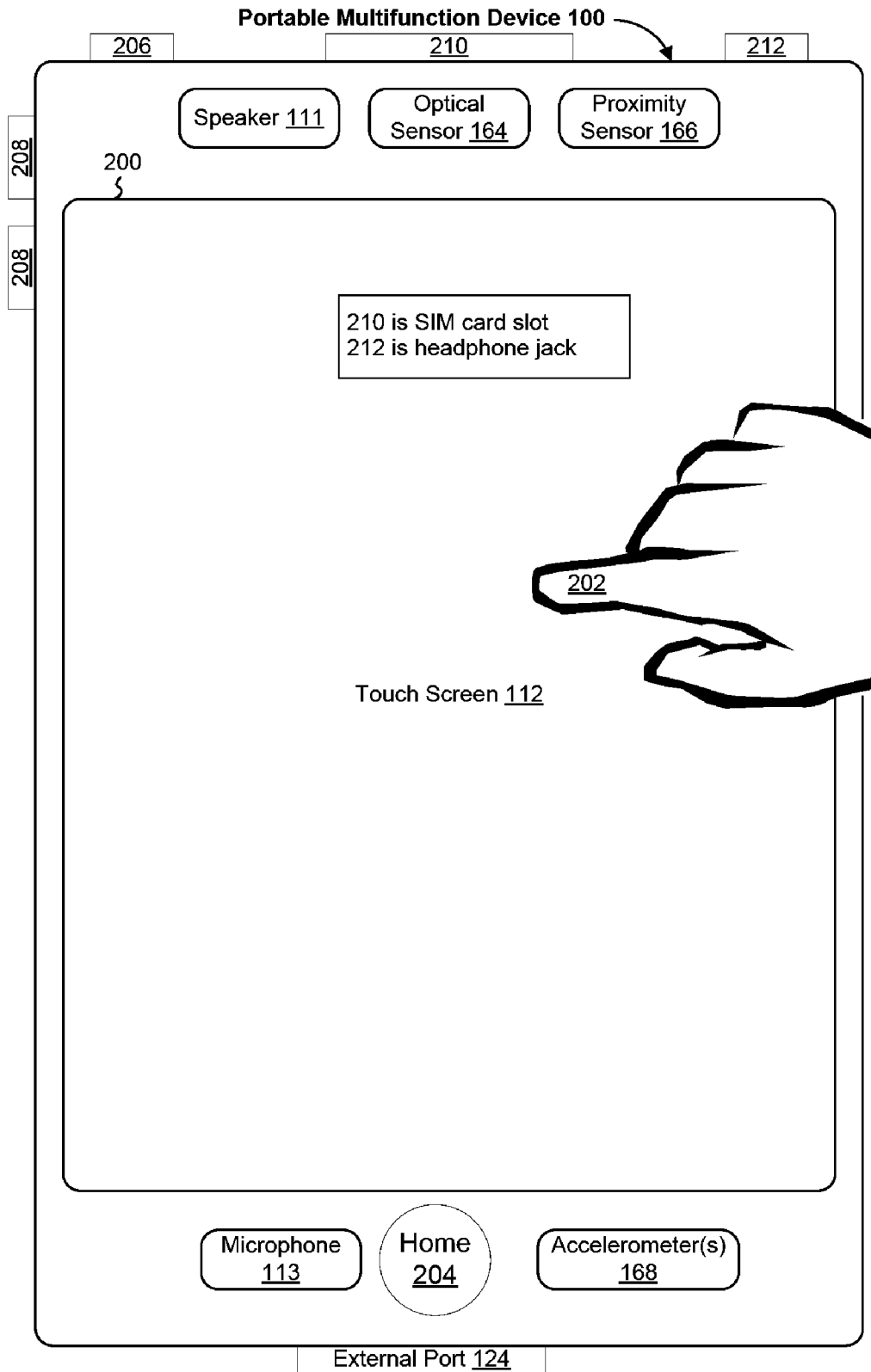

Figure 2

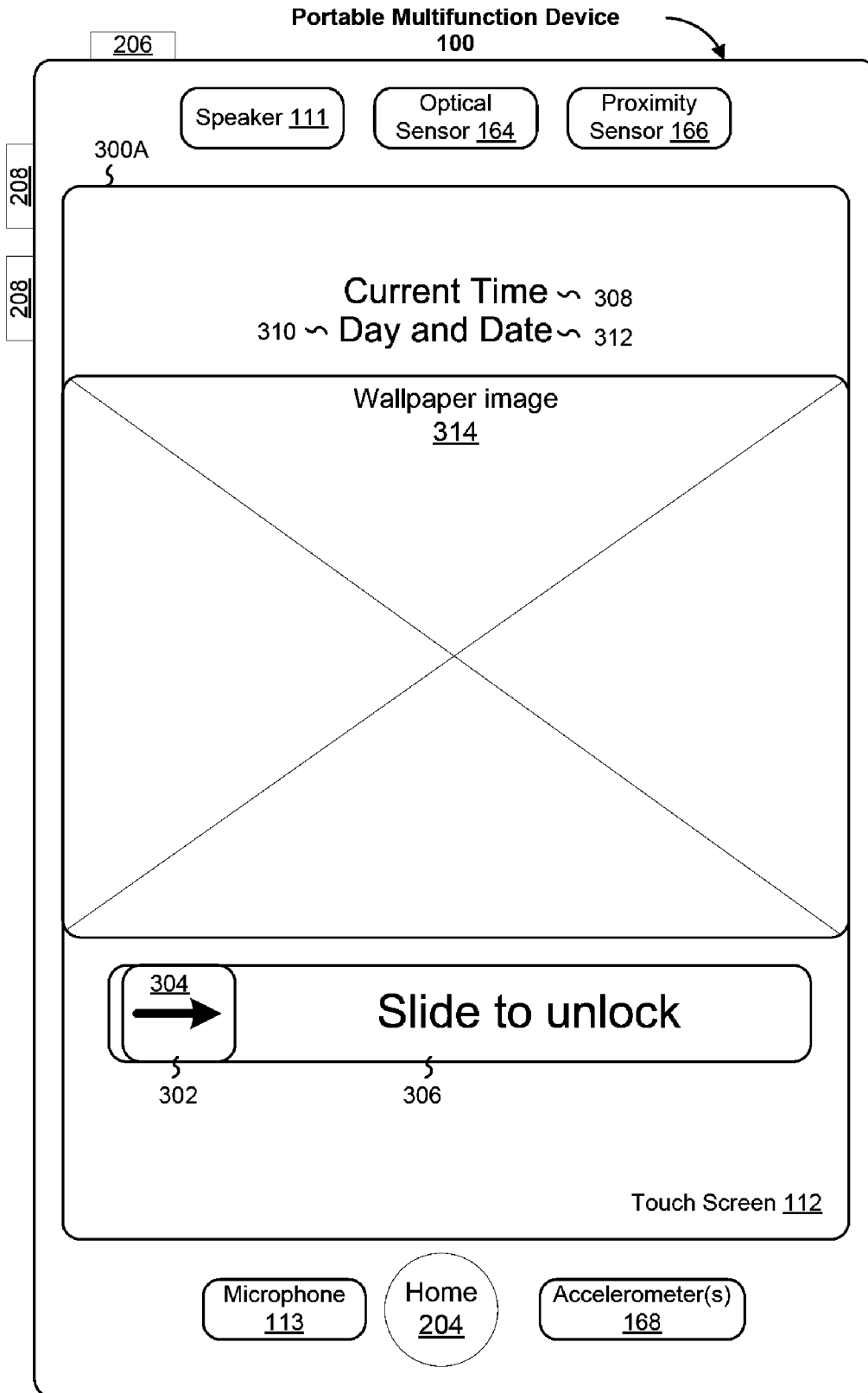

Figure 3A

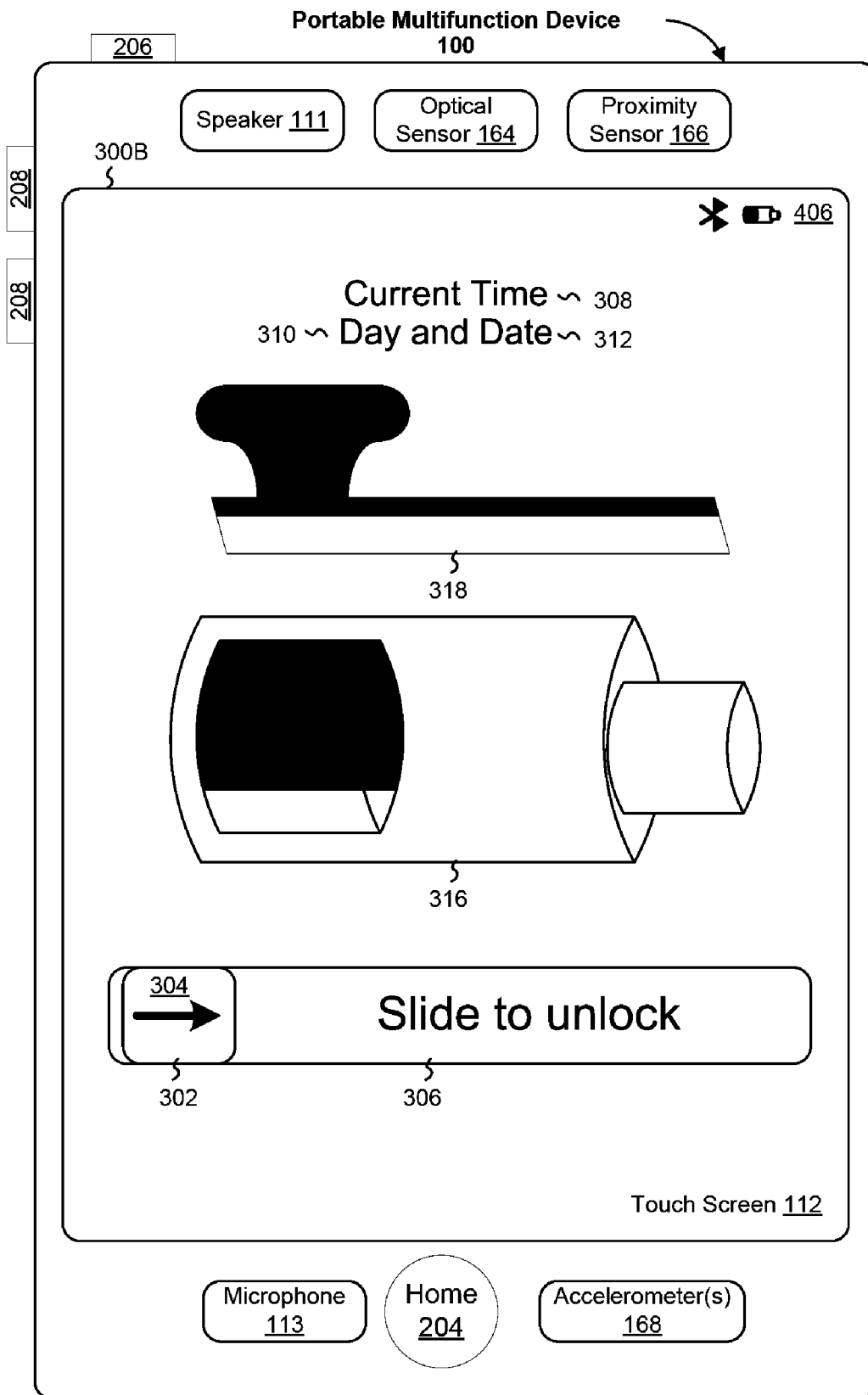

Figure 3B



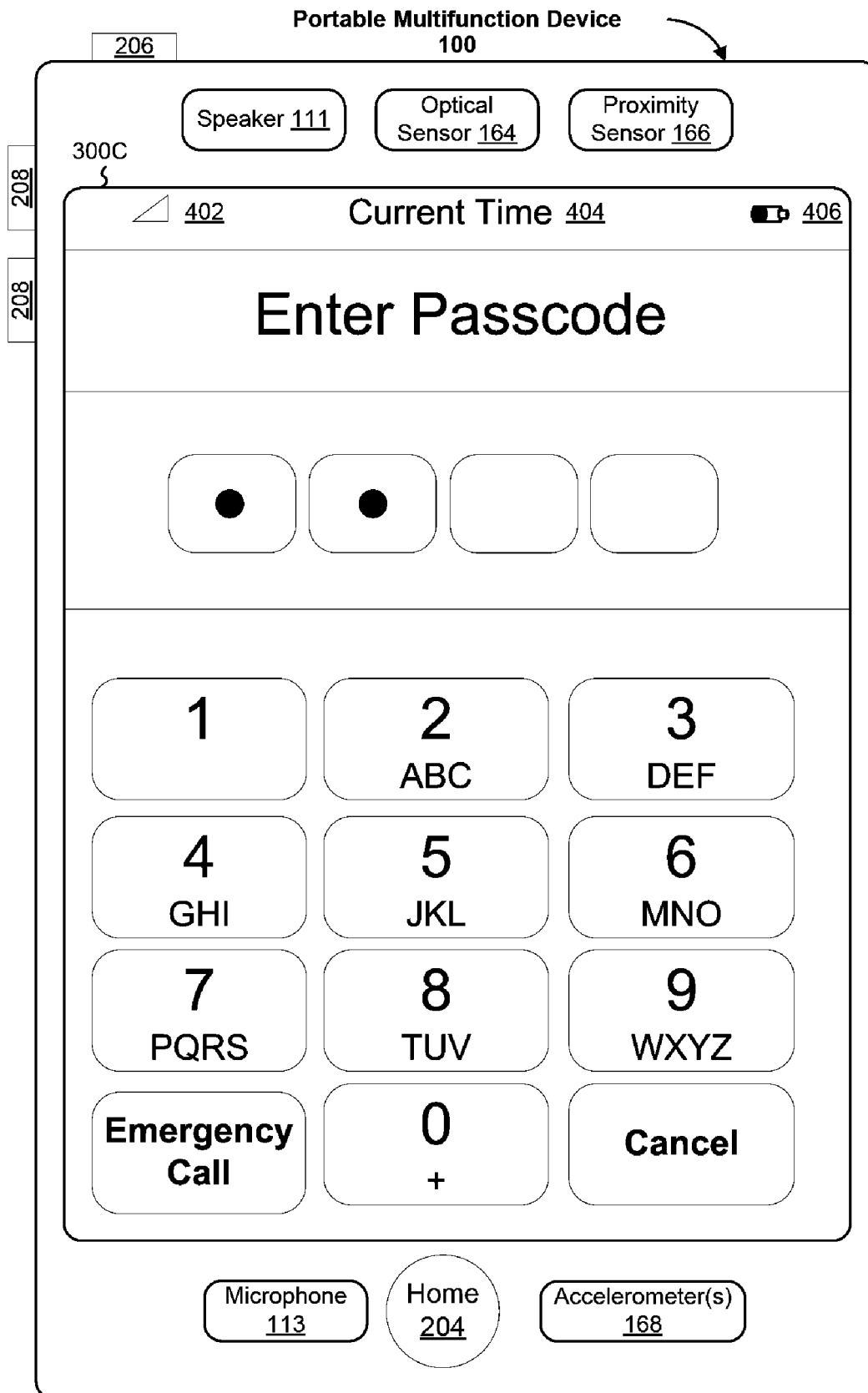

Figure 3C

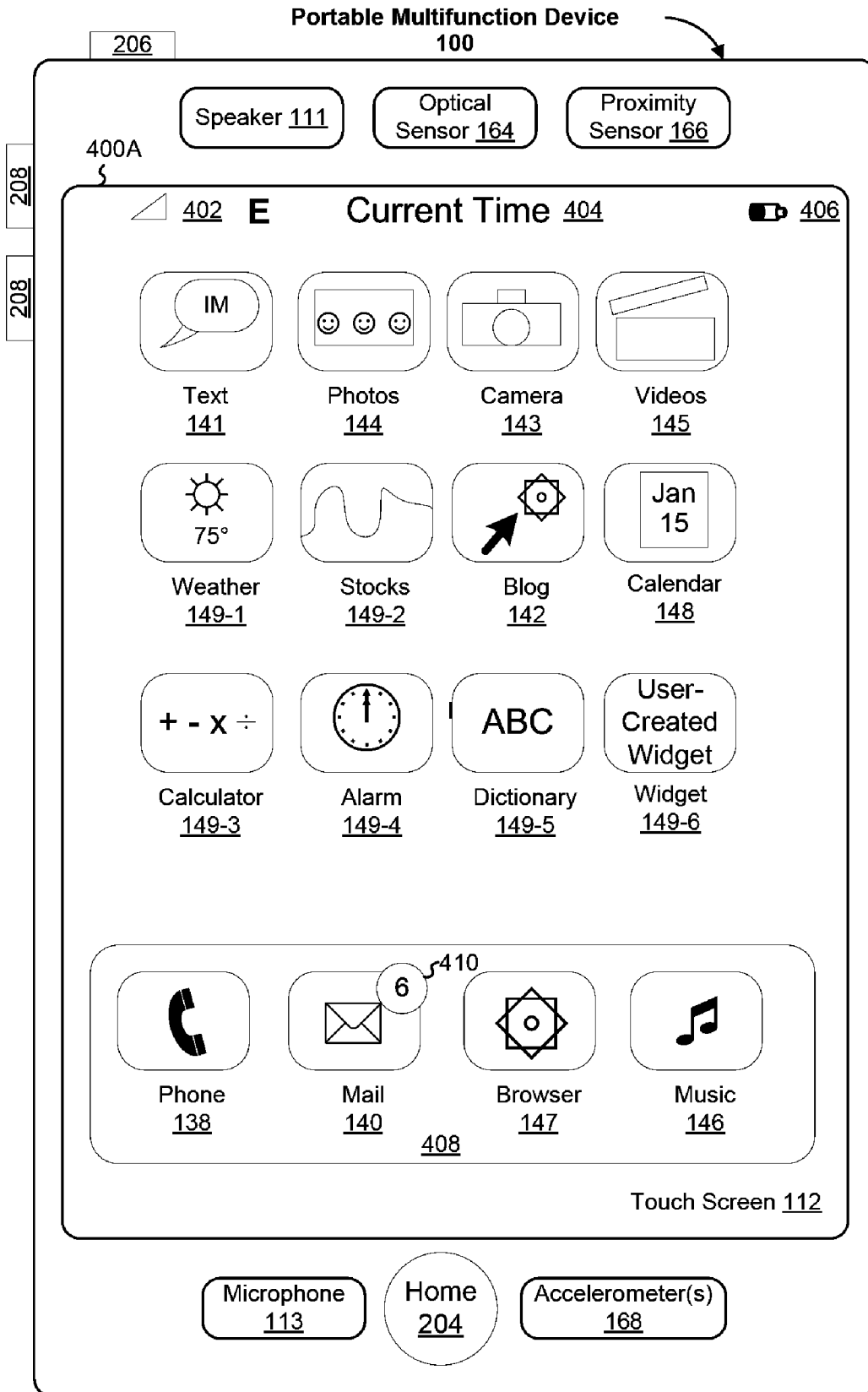

Figure 4A

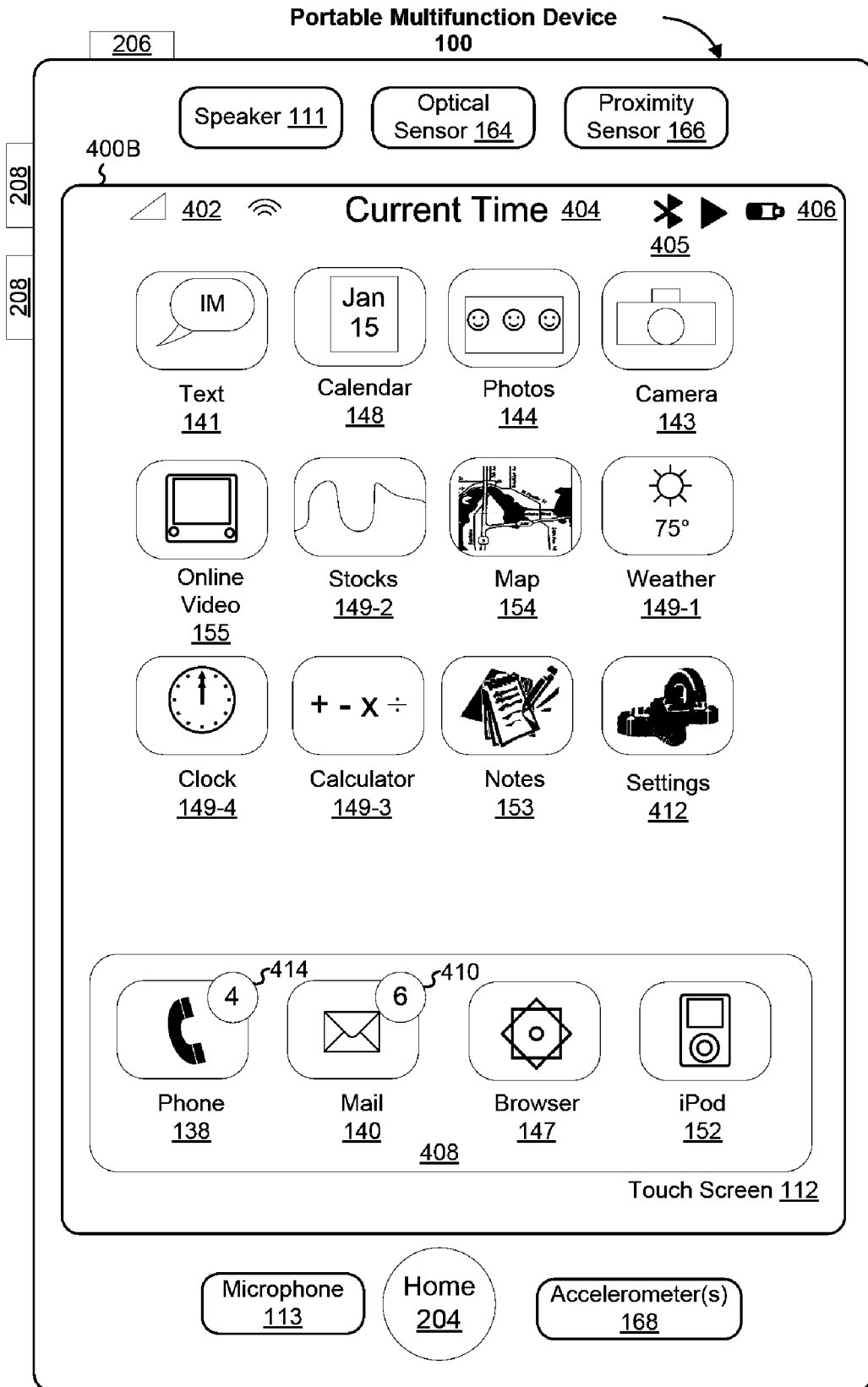

Figure 4B

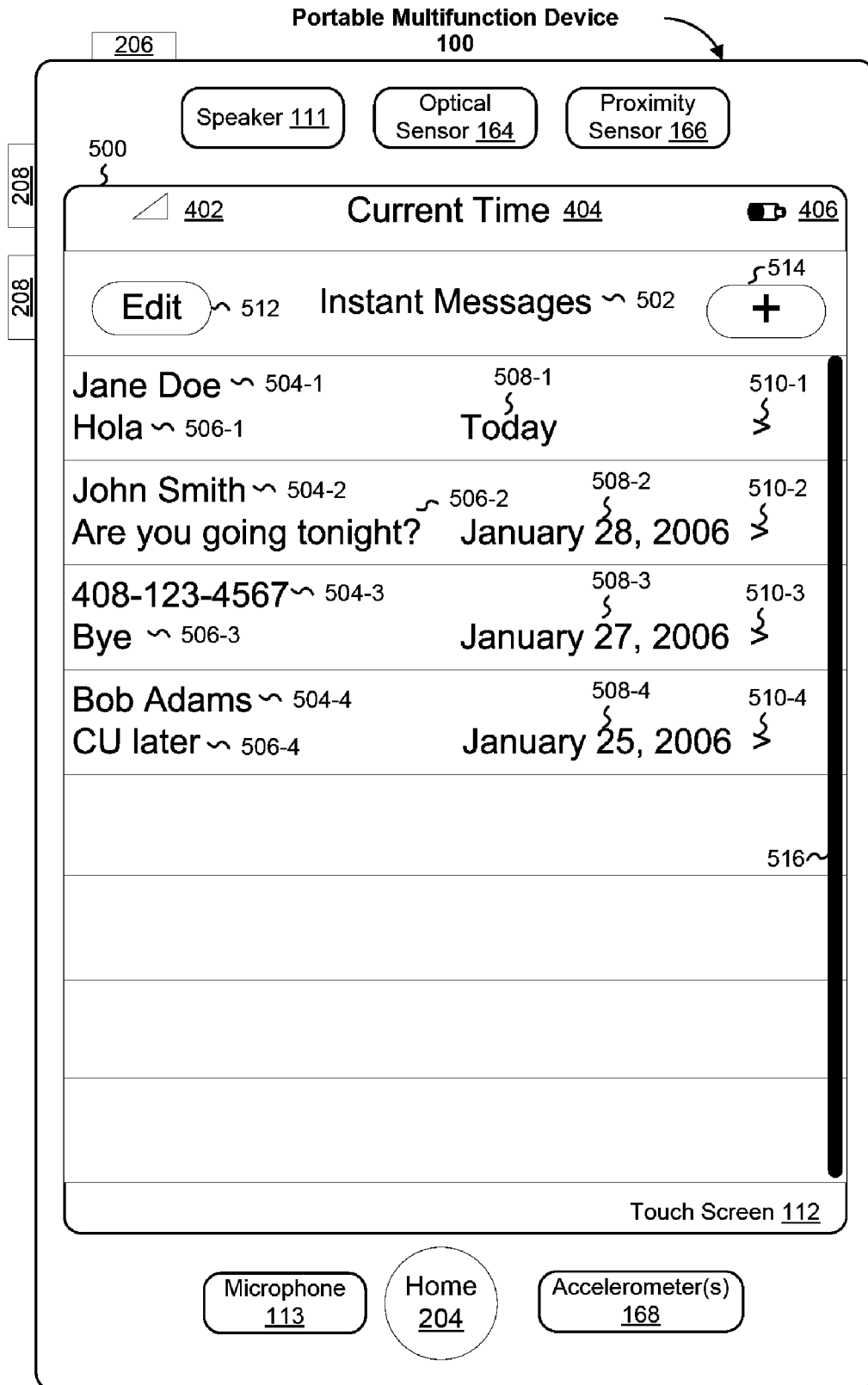

Figure 5

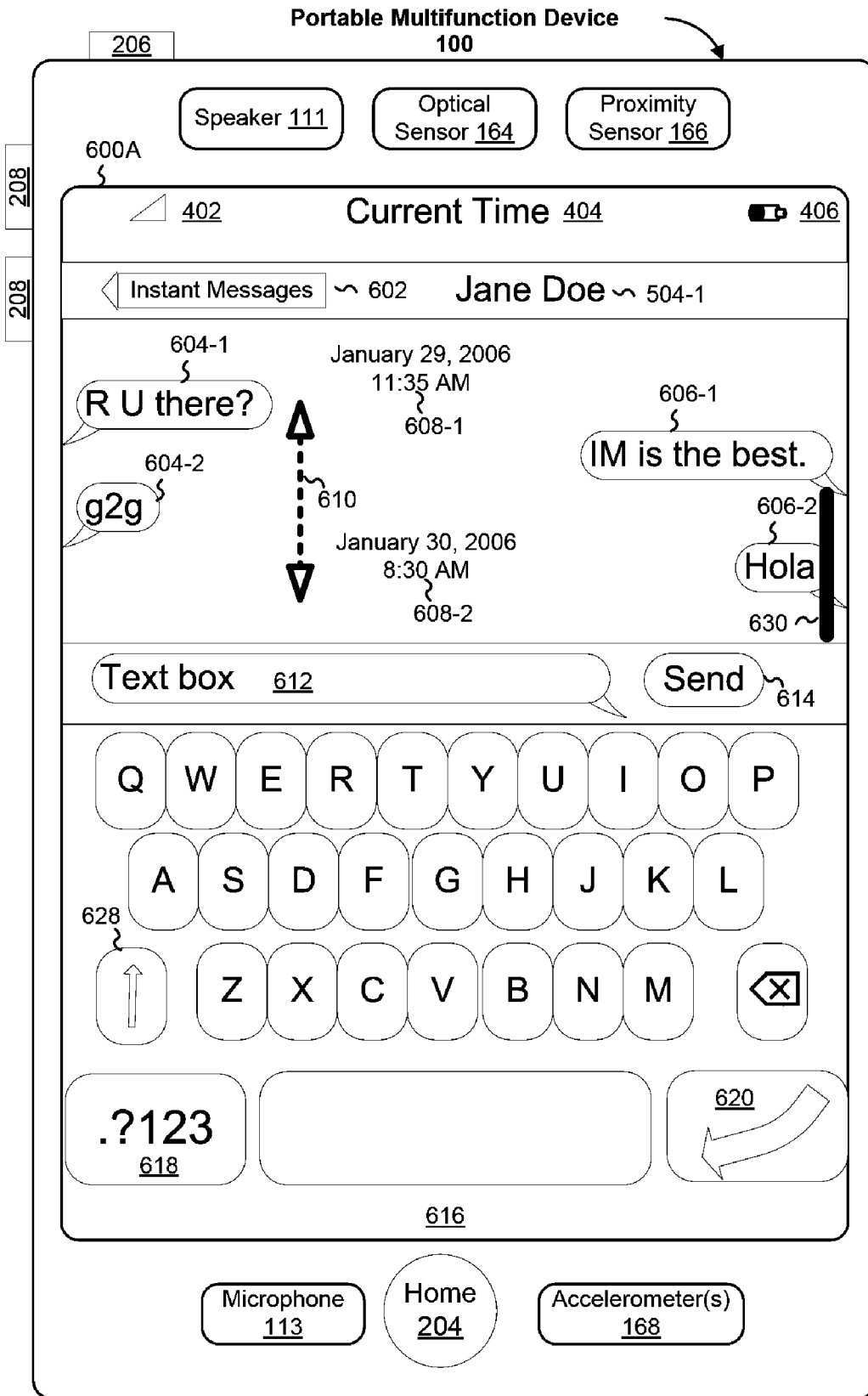

Figure 6A

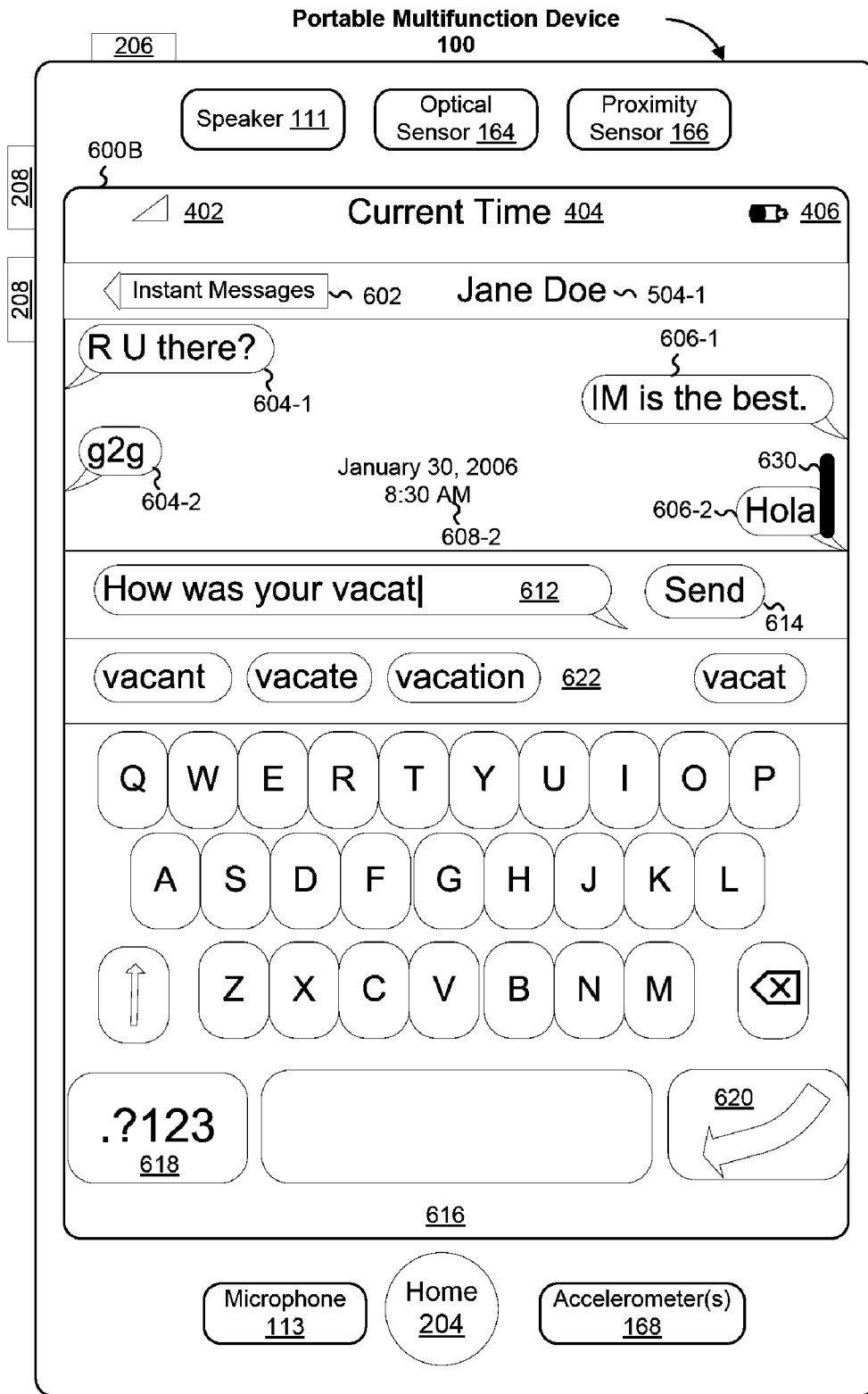

Figure 6B

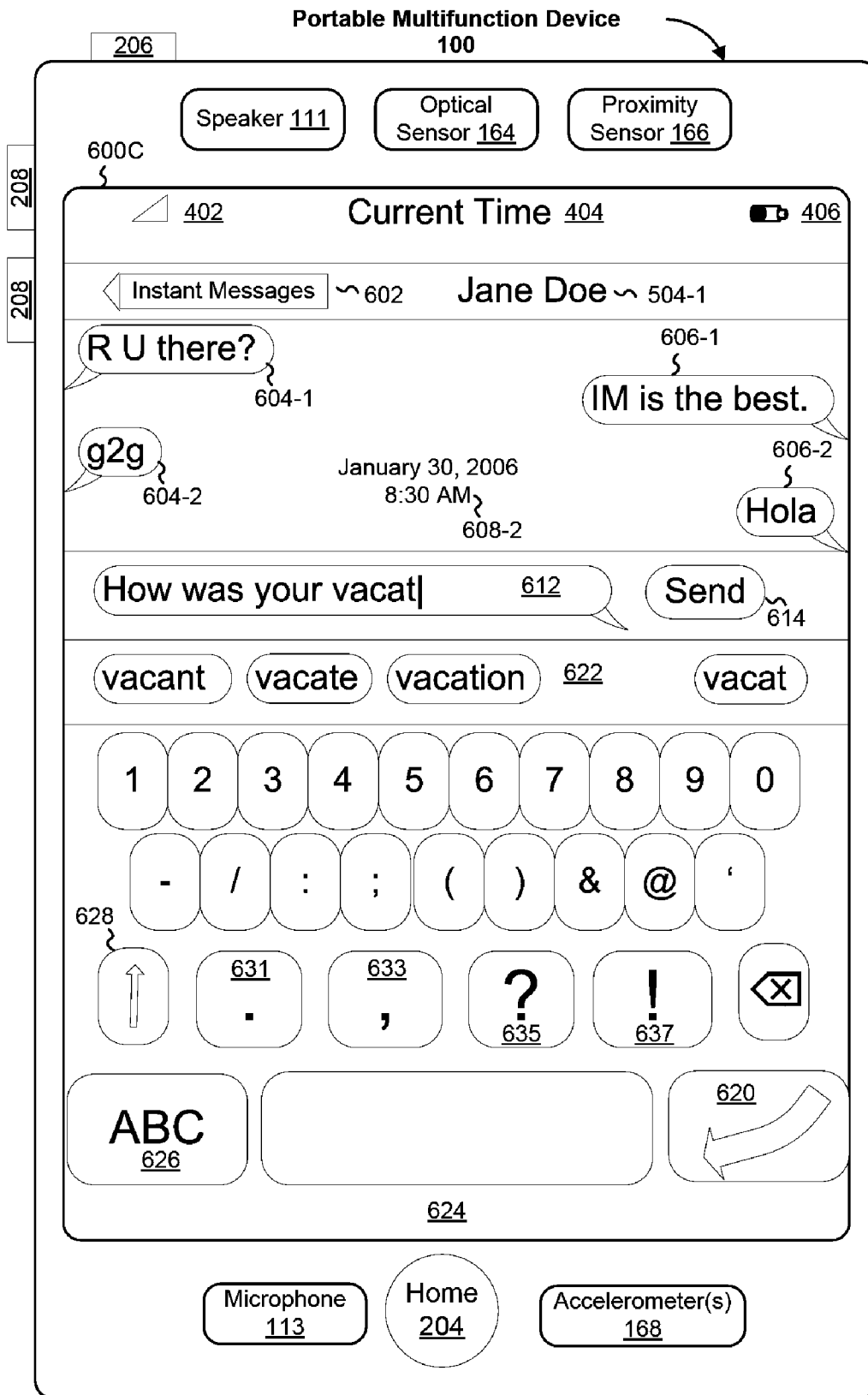

Figure 6C

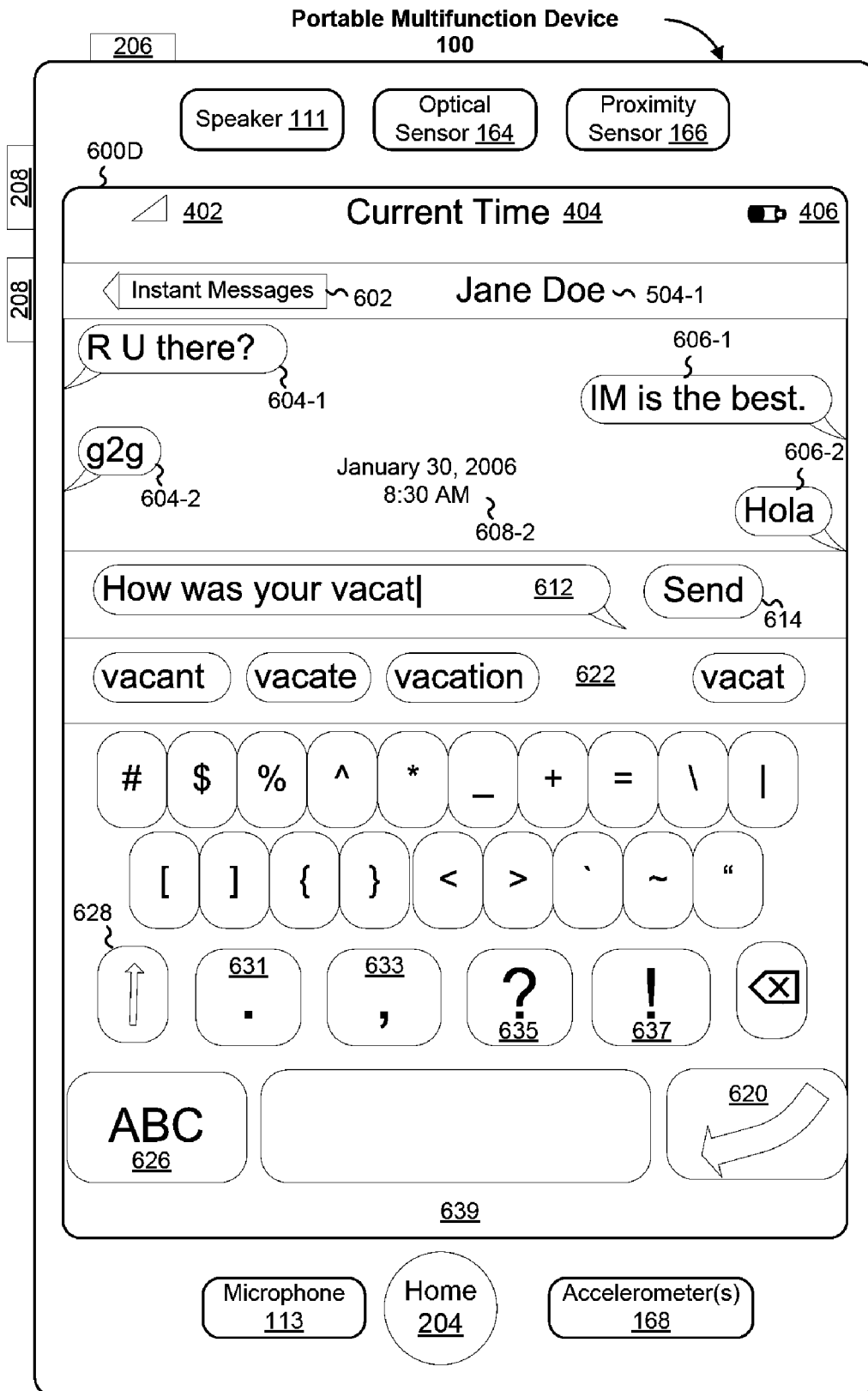

Figure 6D



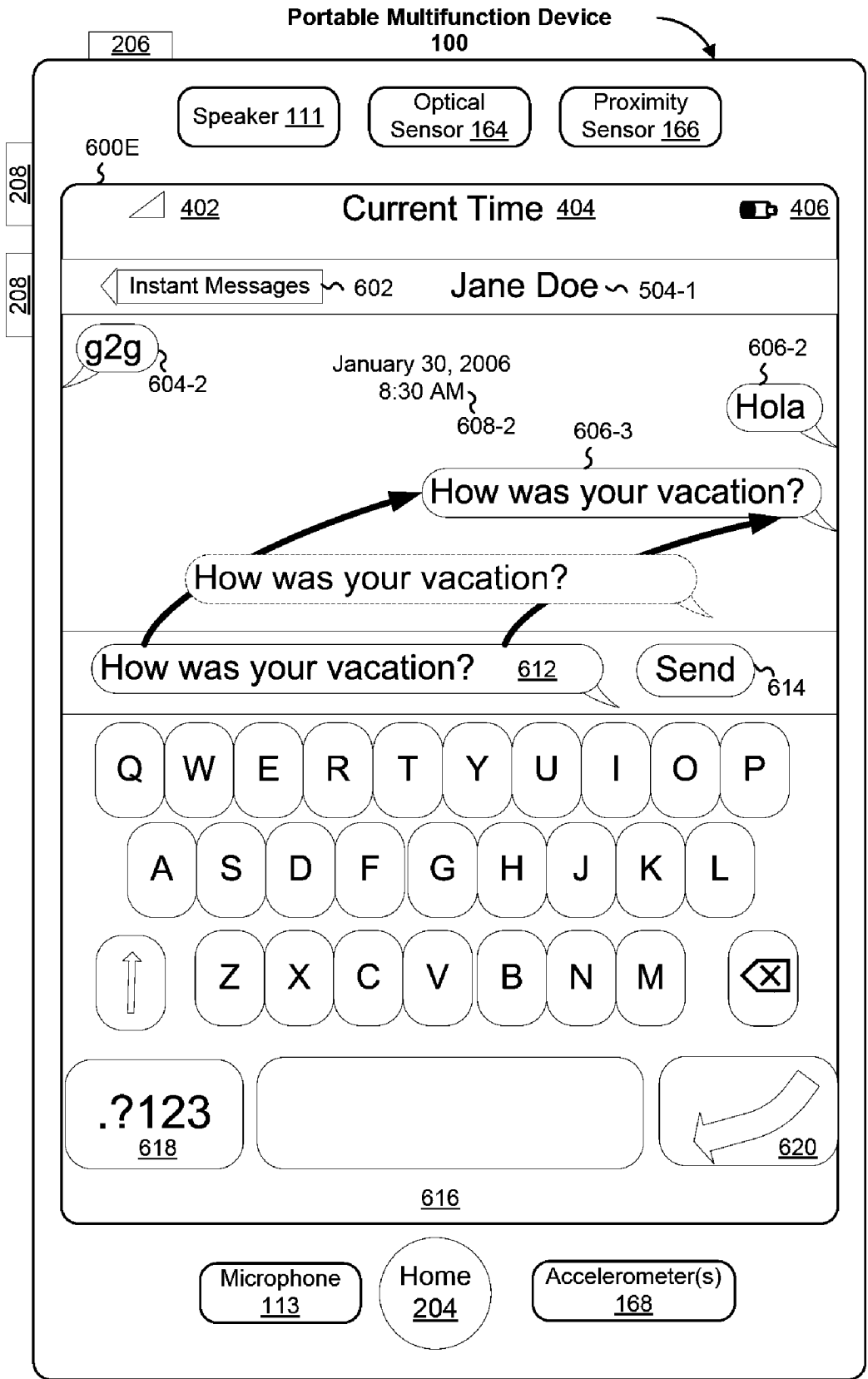

Figure 6E



Figure 6F

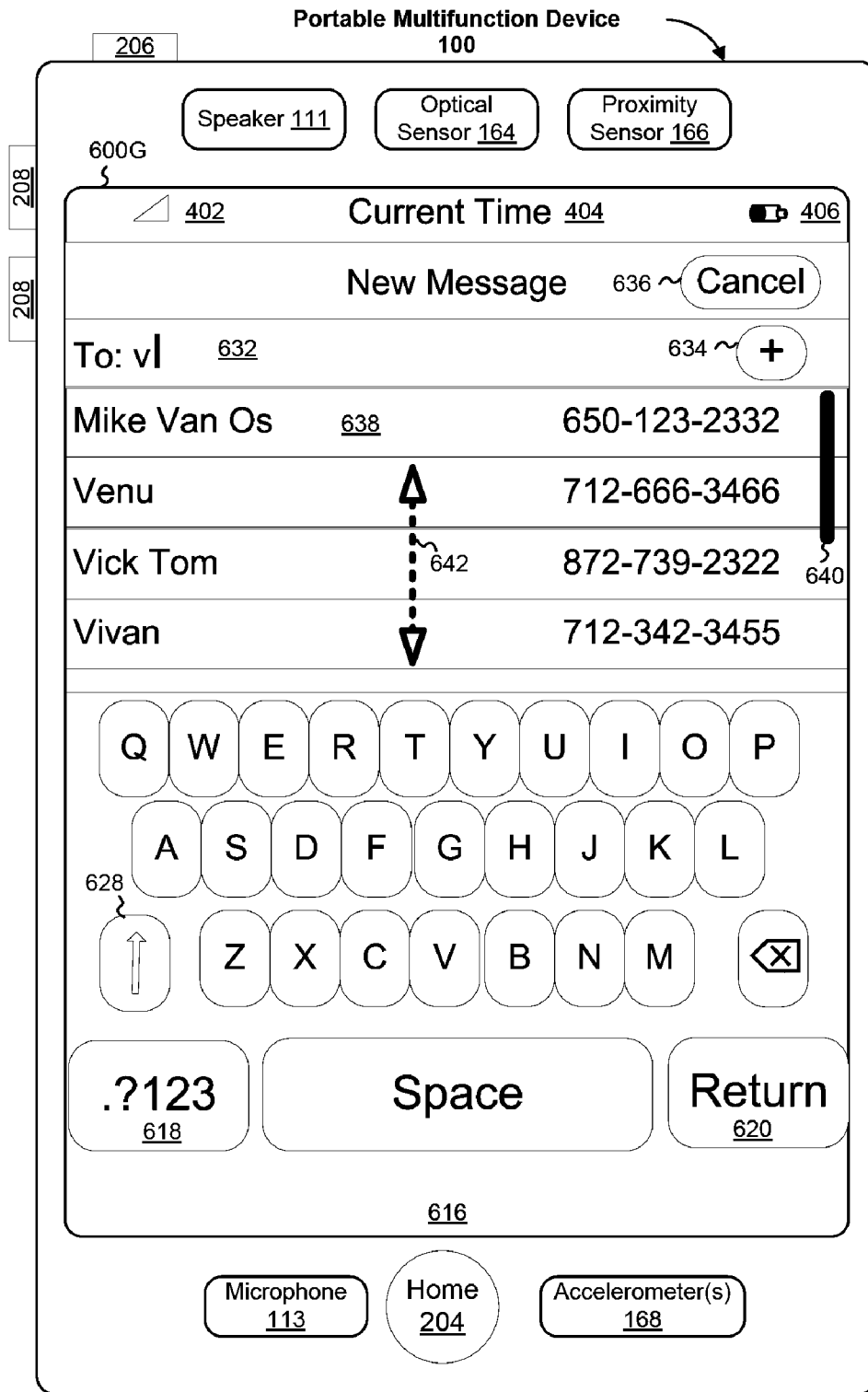

Figure 6G



Figure 6H

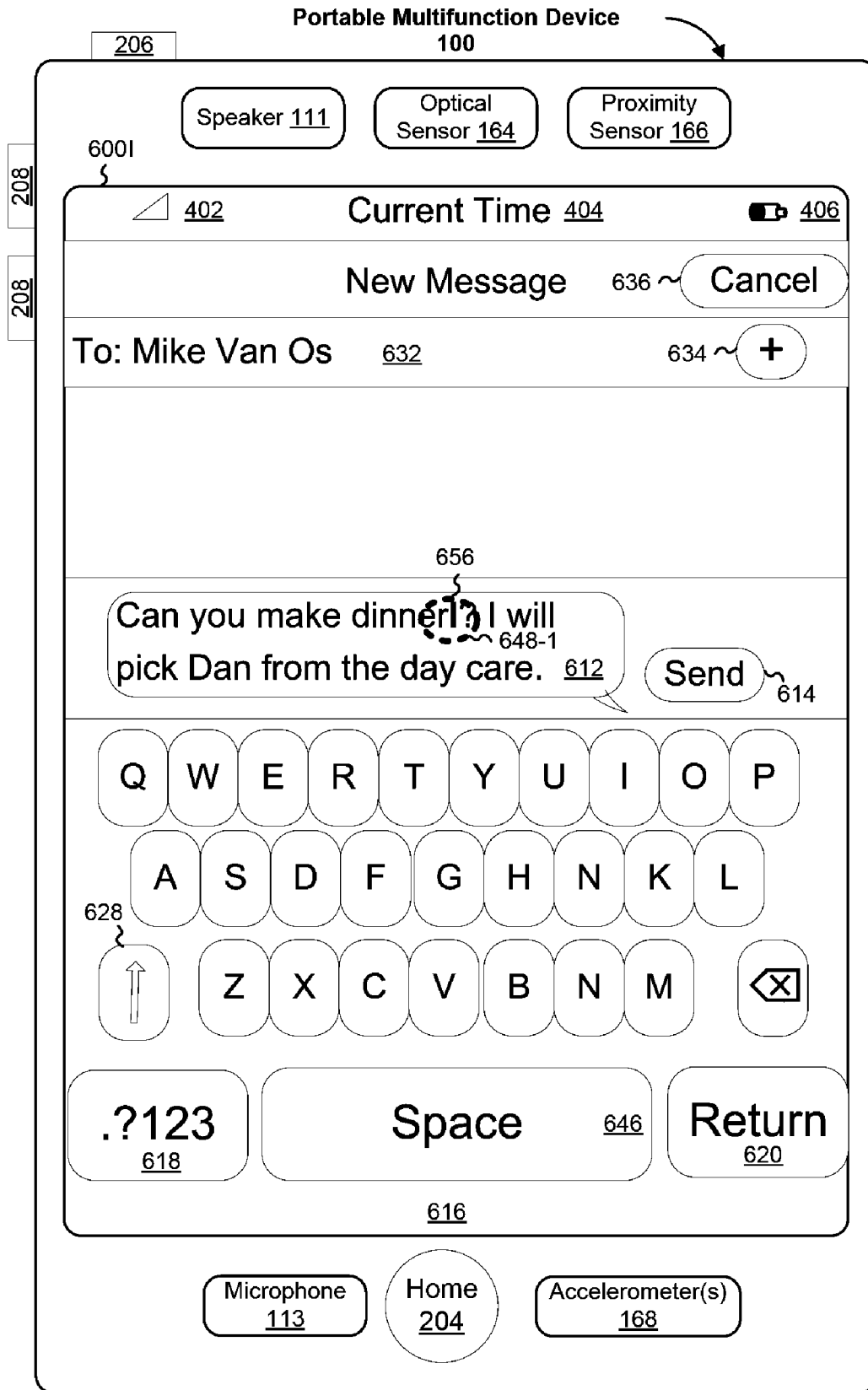

Figure 61



Figure 6J



Figure 6K

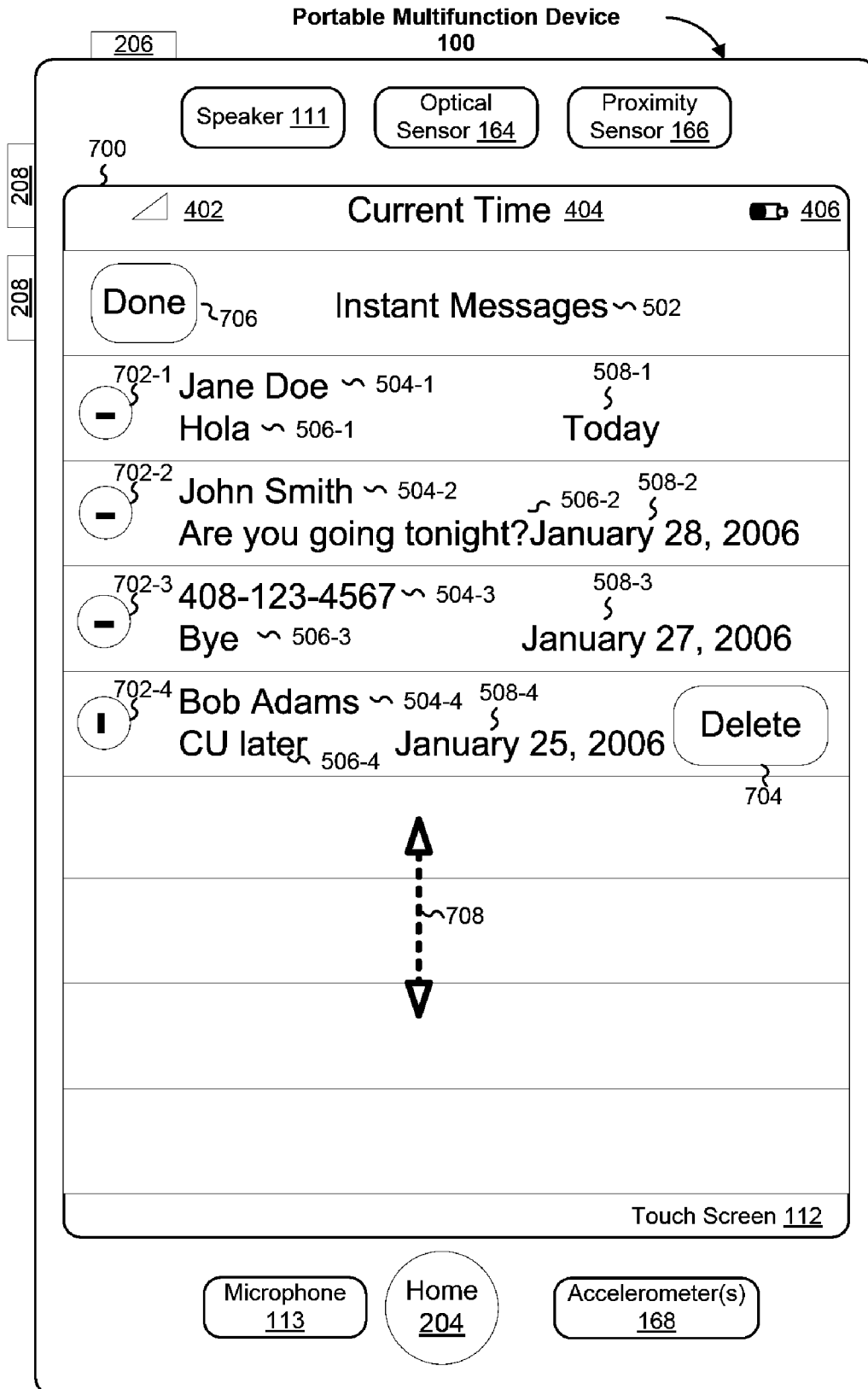

Figure 7



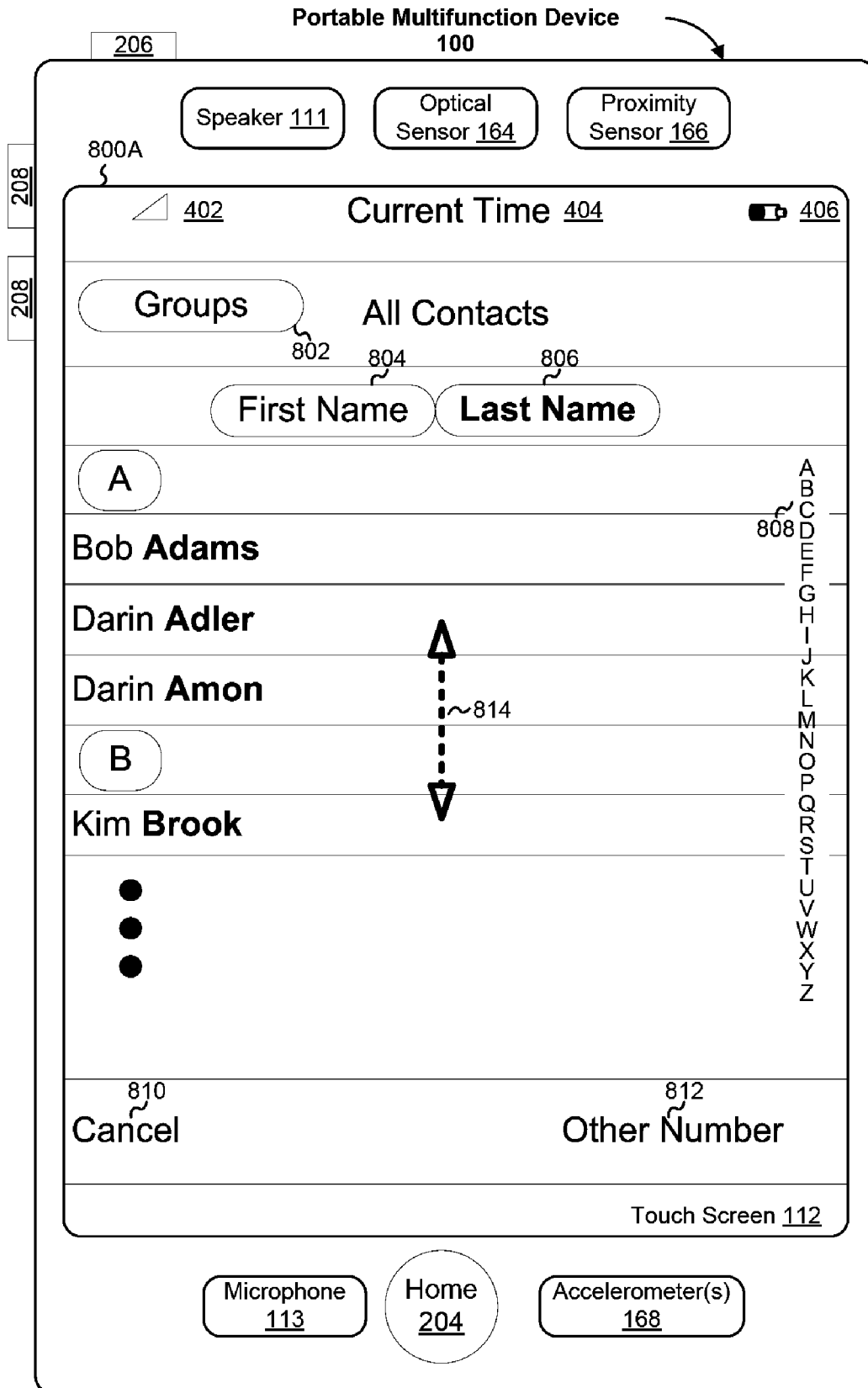

Figure 8A

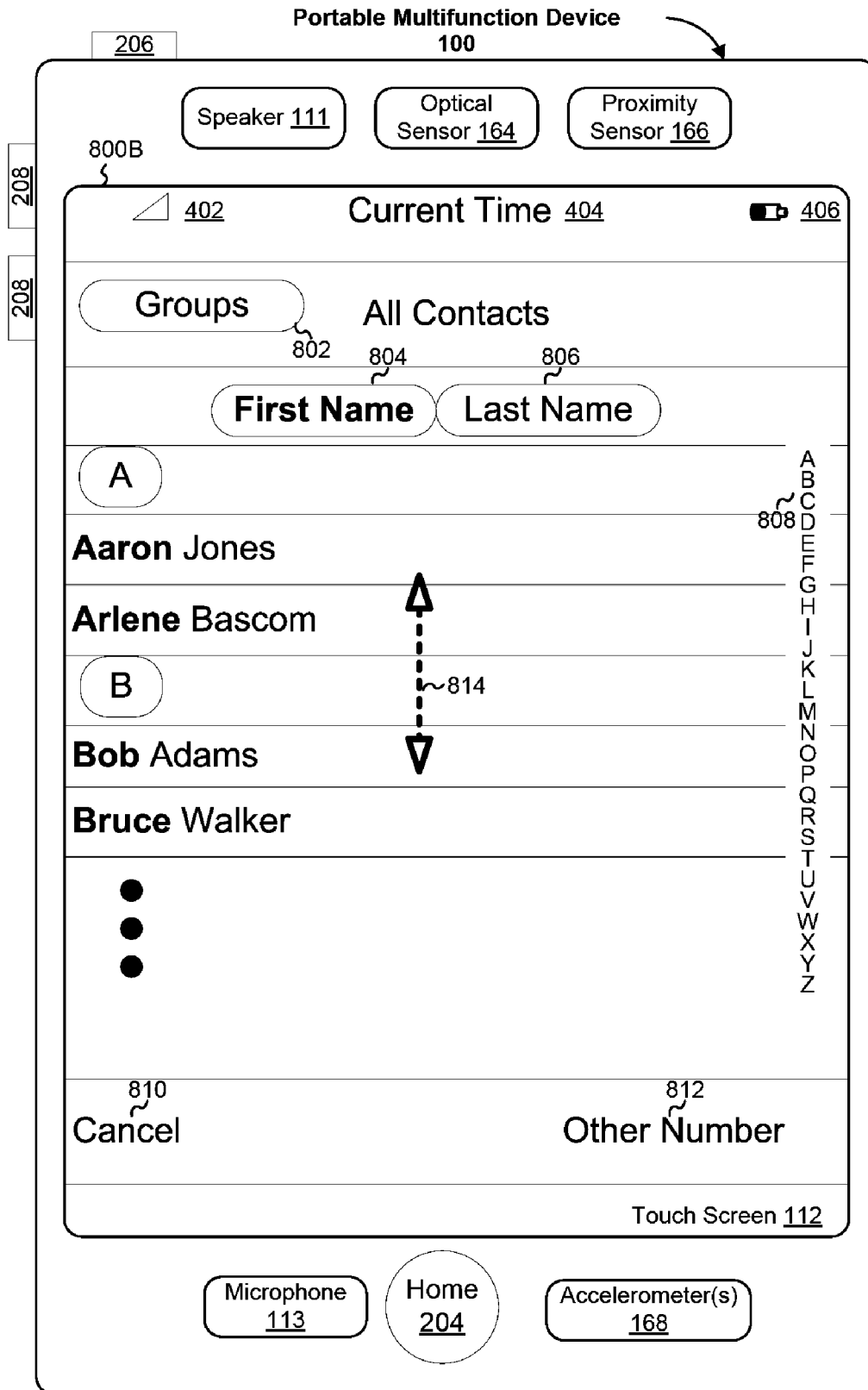

Figure 8B

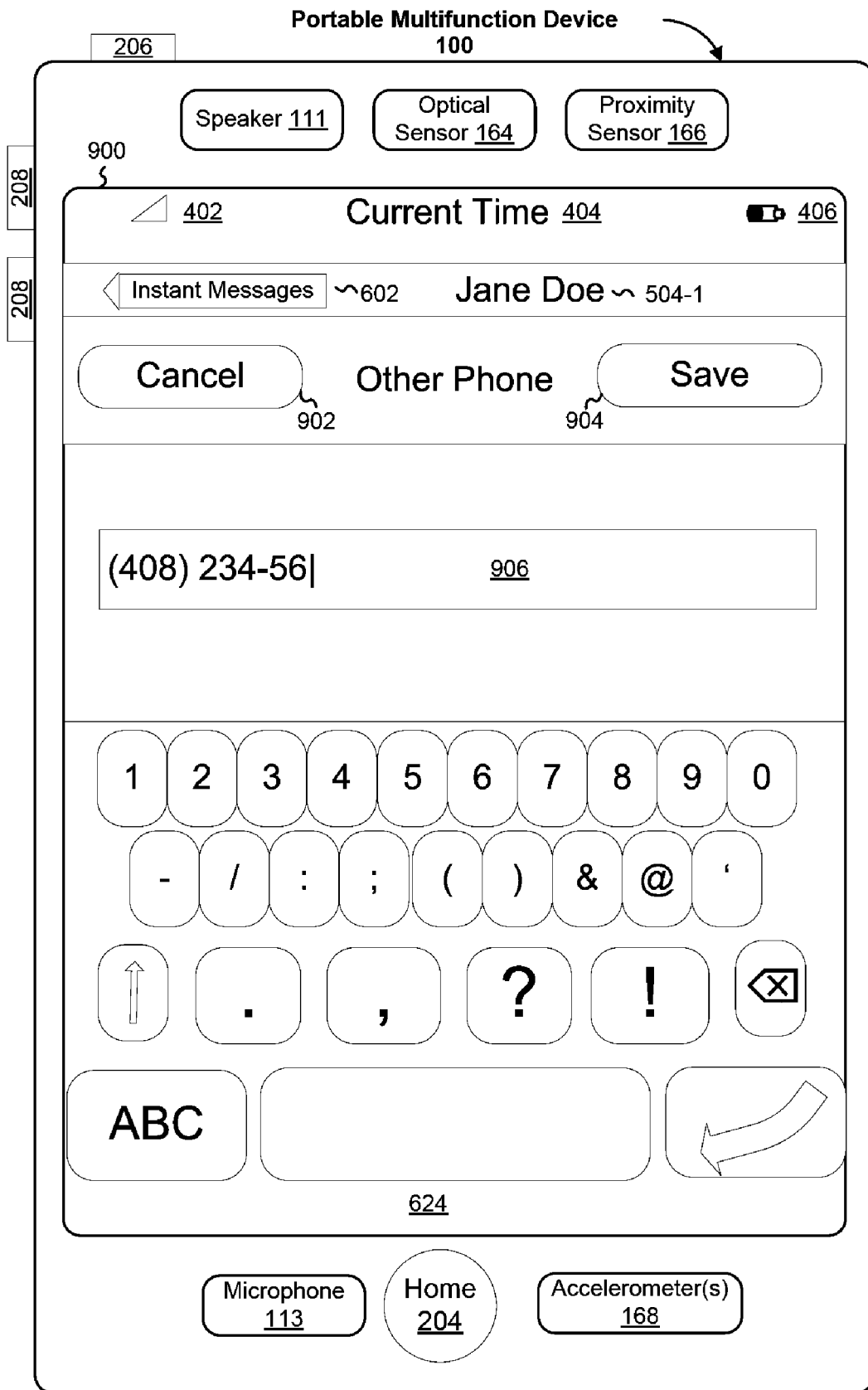

Figure 9

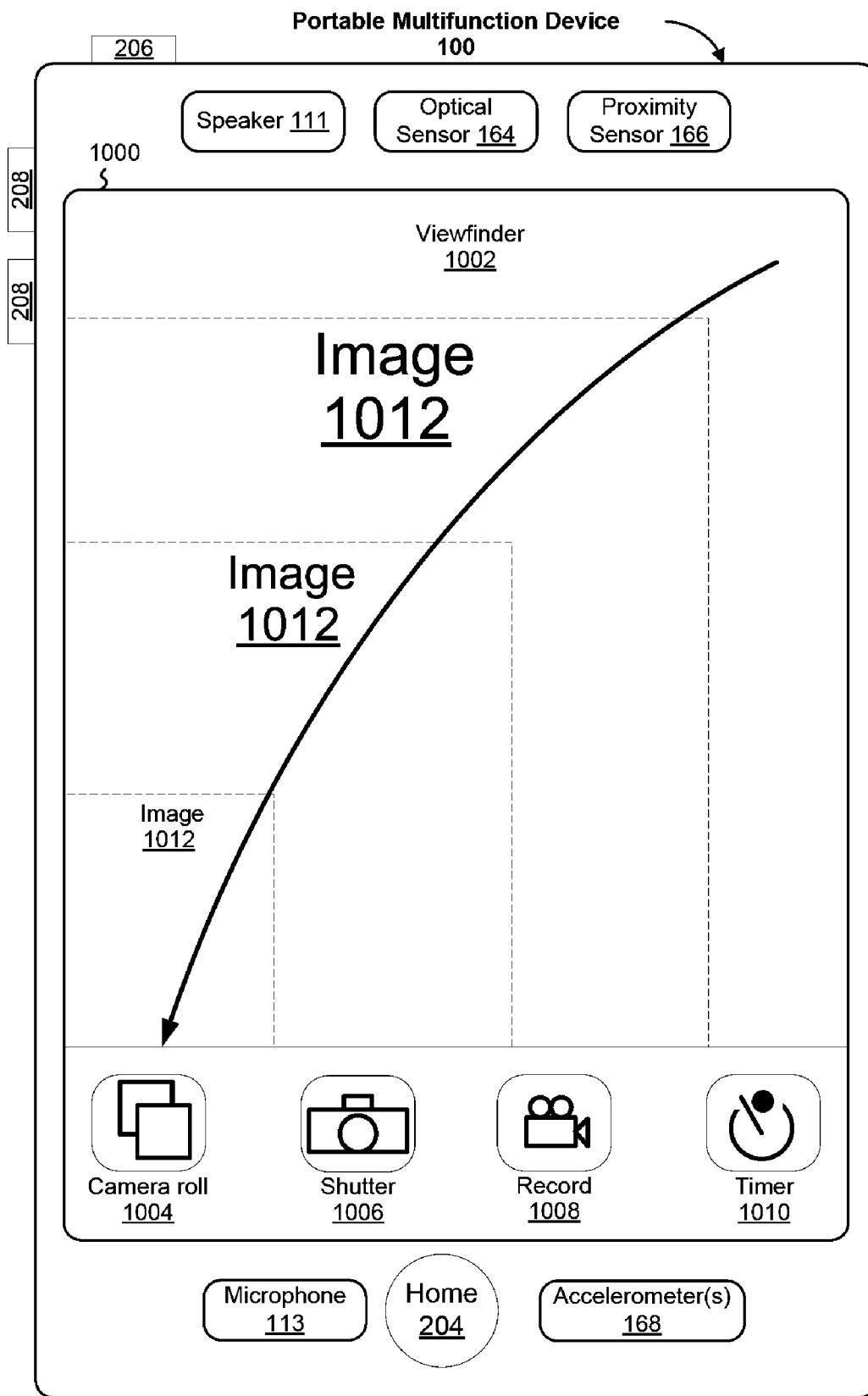

Figure 10

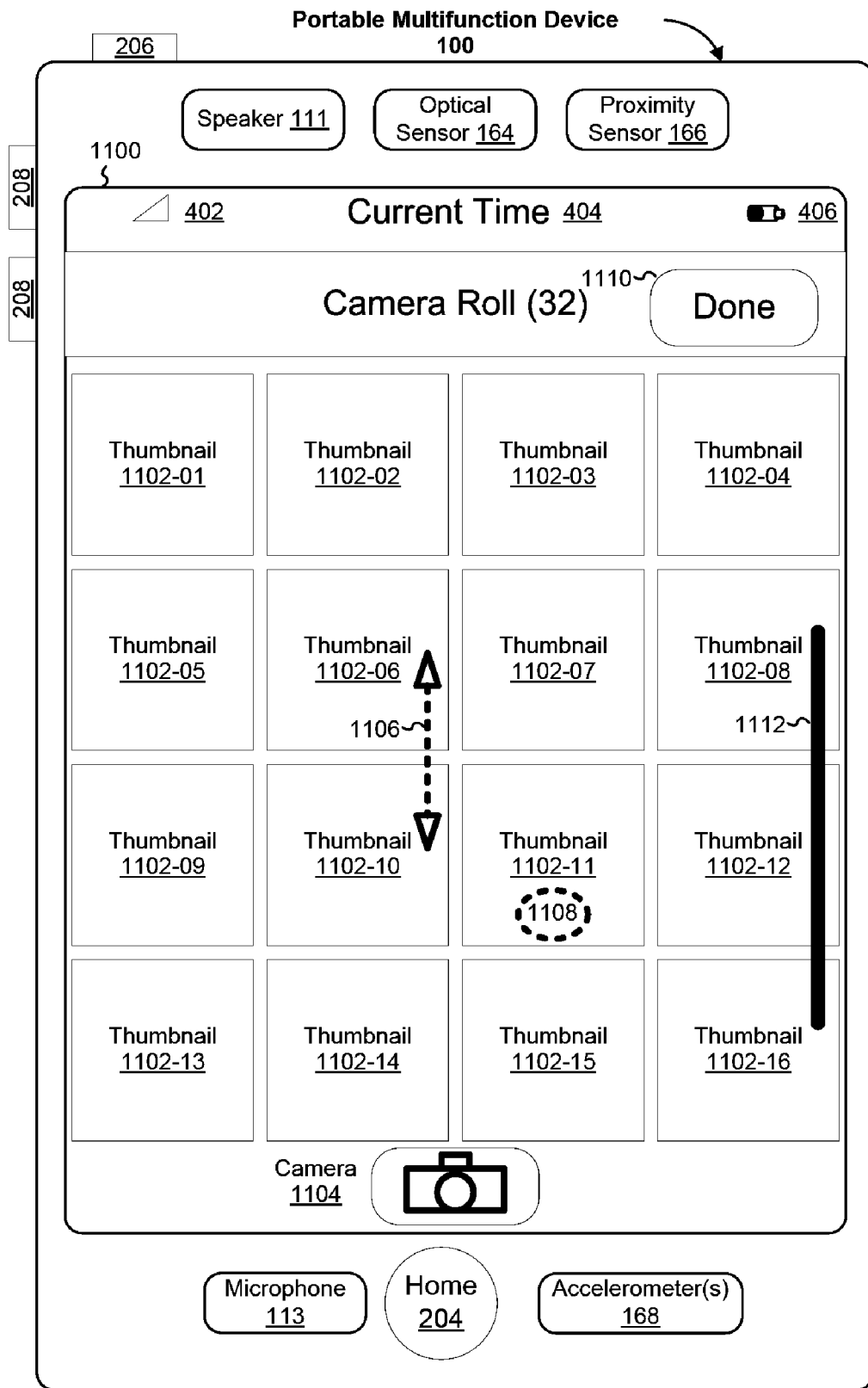

Figure 11

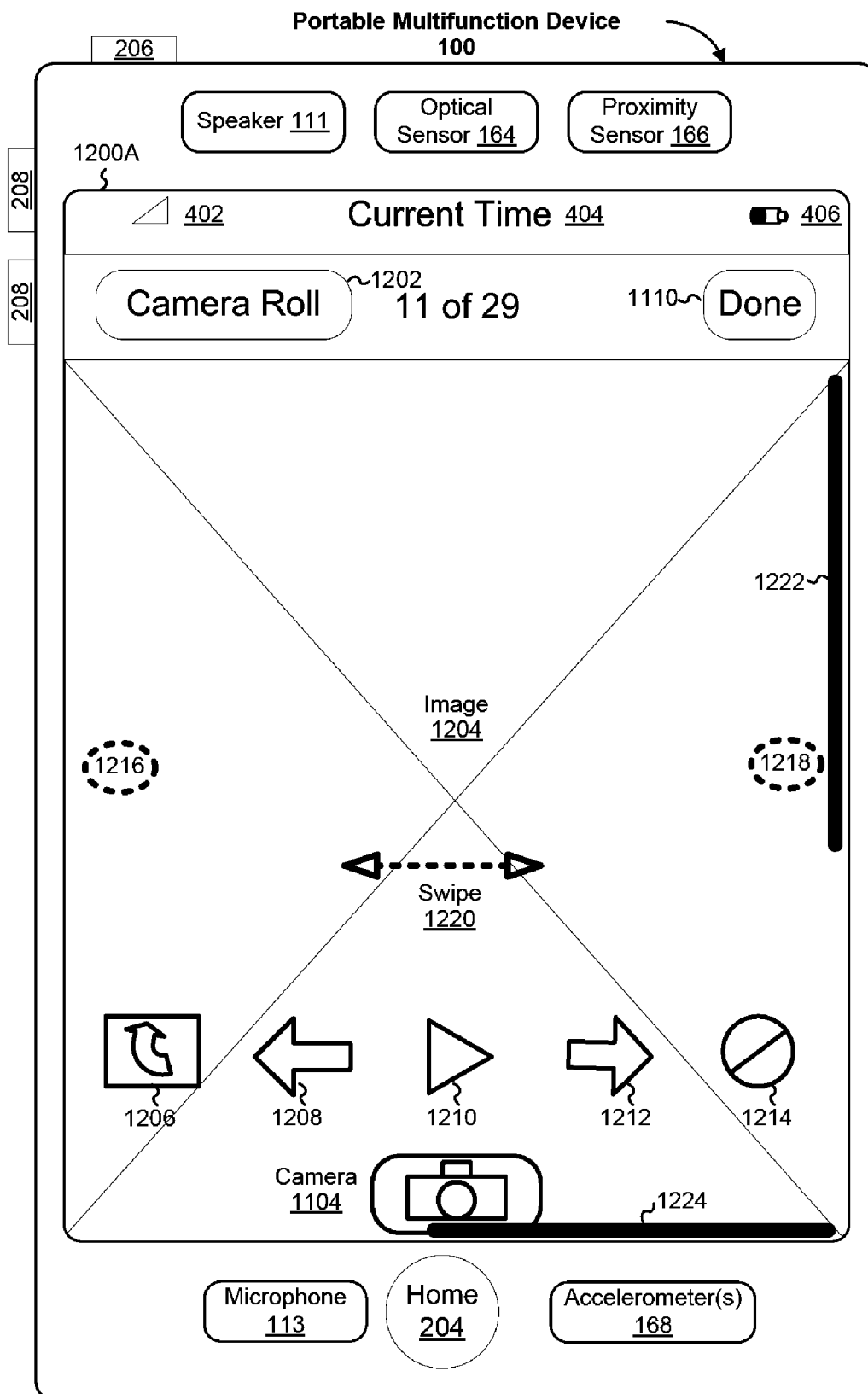

Figure 12A

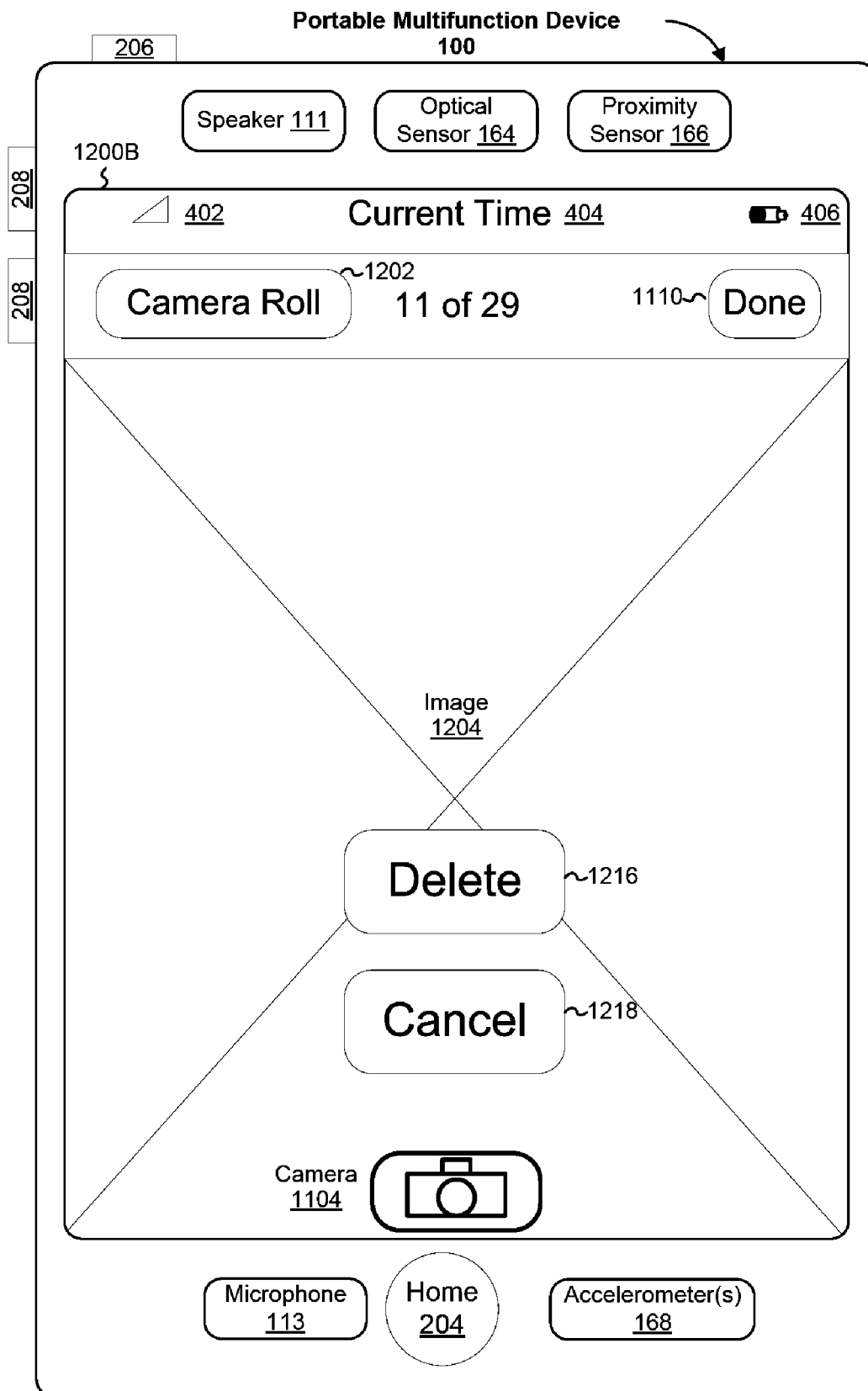

Figure 12B

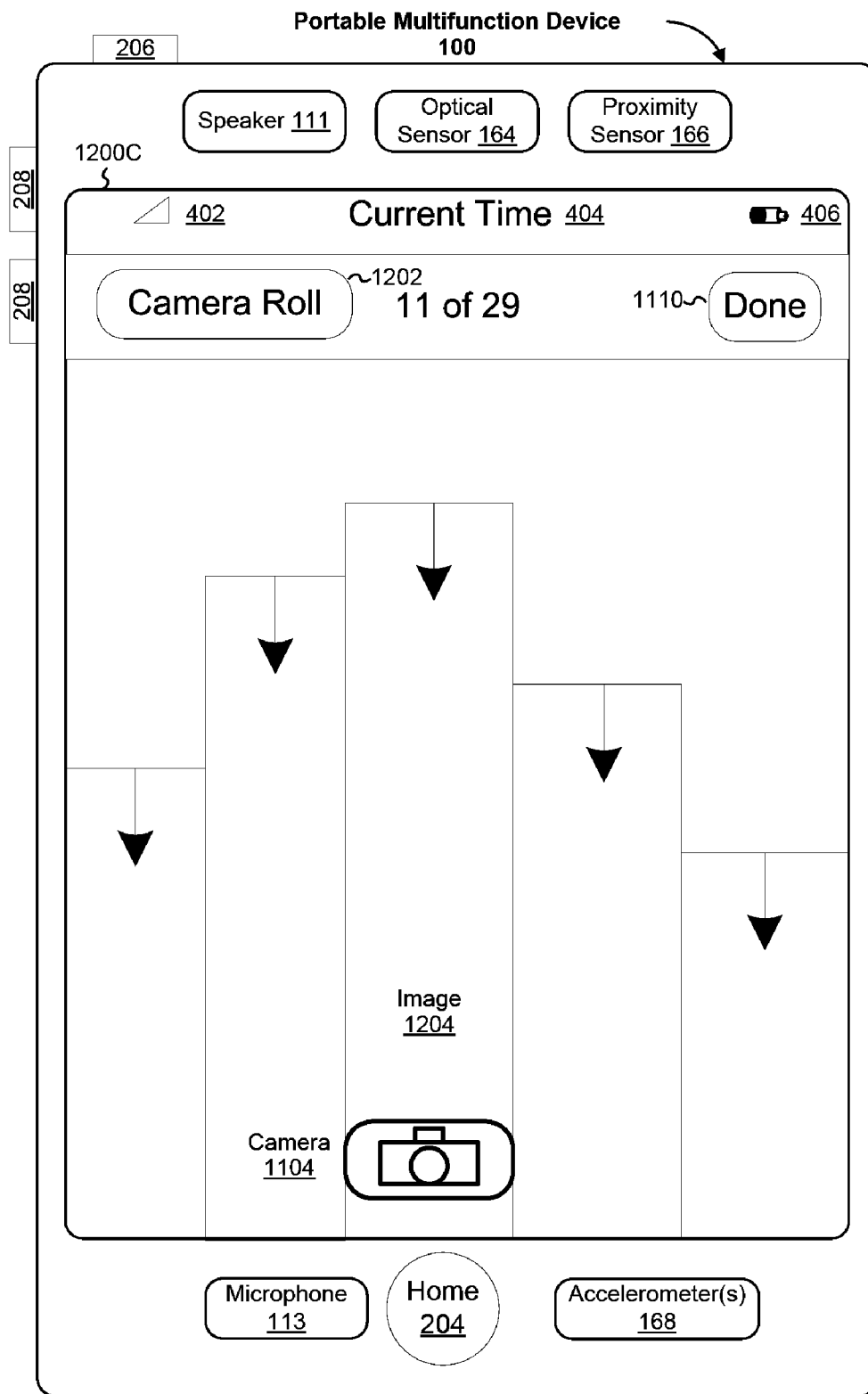

Figure 12C



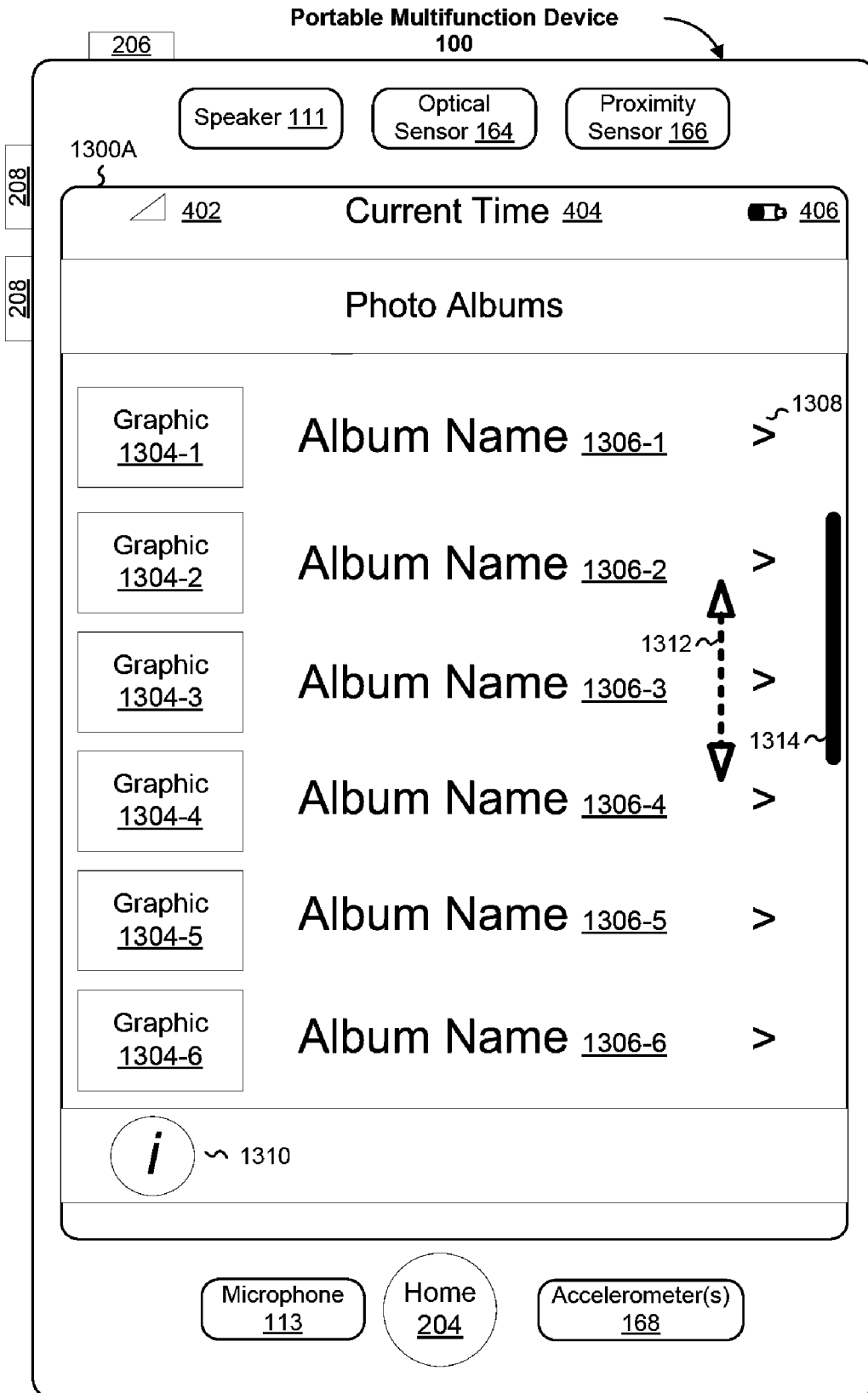

Figure 13A

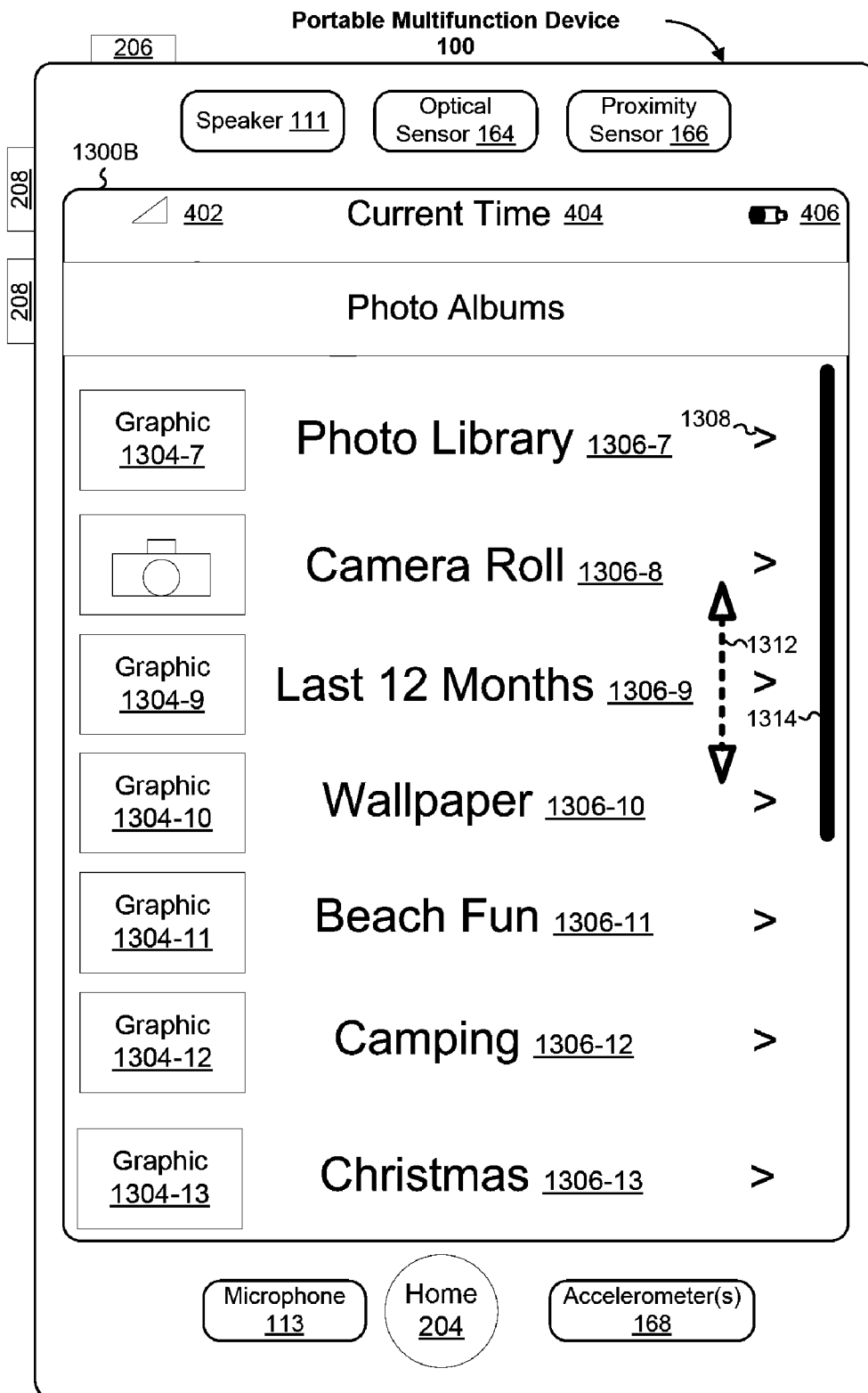

Figure 13B

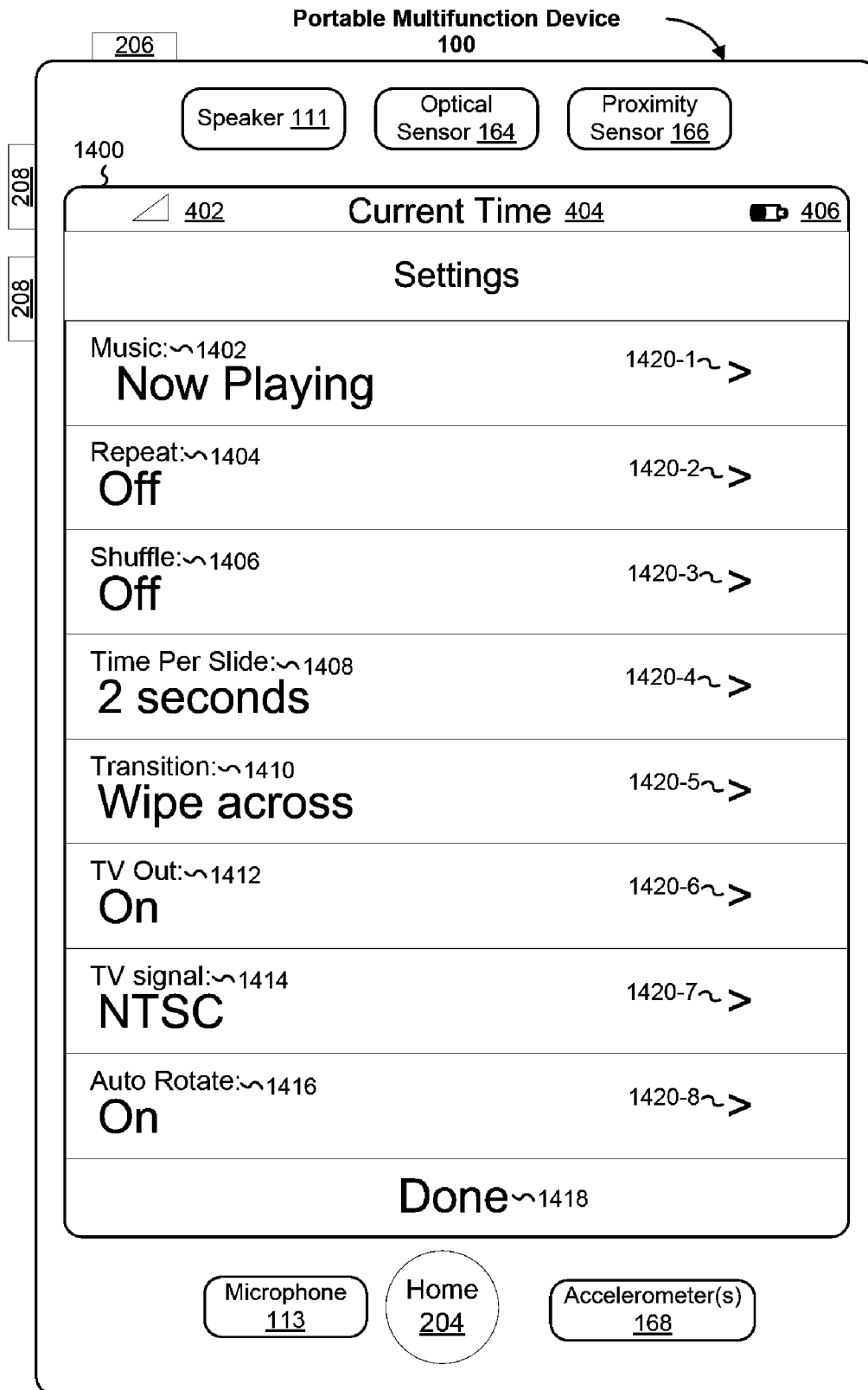

Figure 14

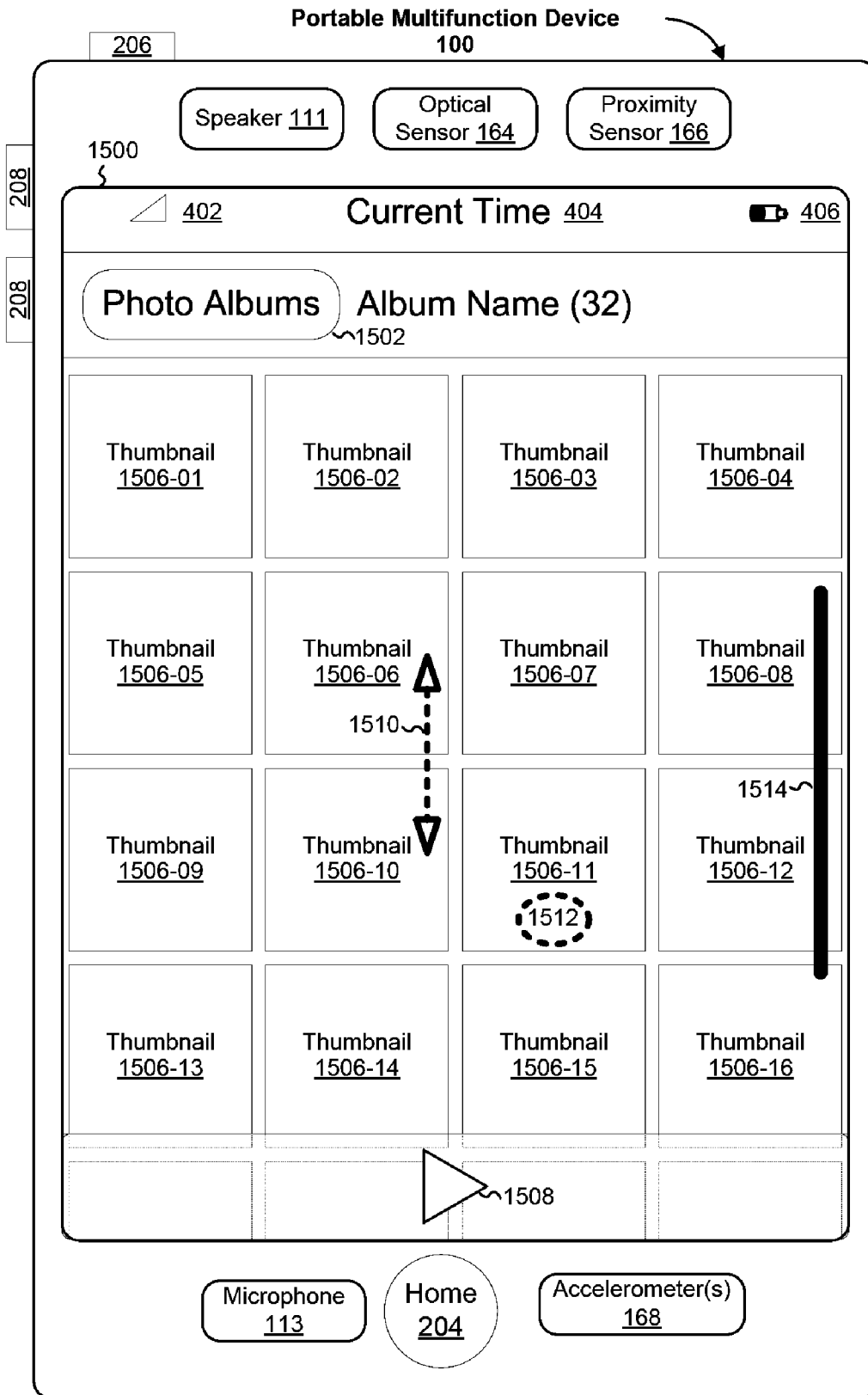

Figure 15

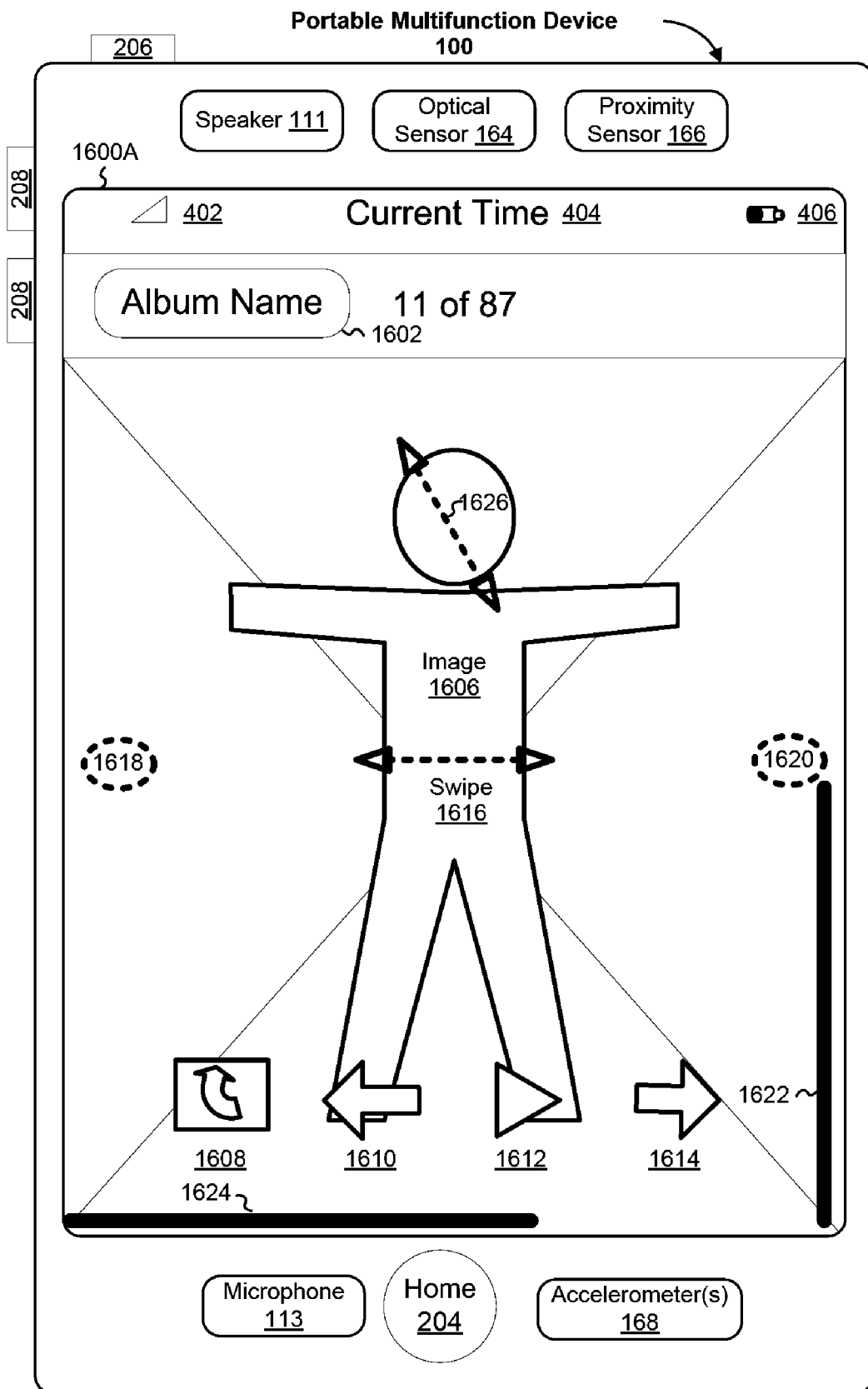

Figure 16A

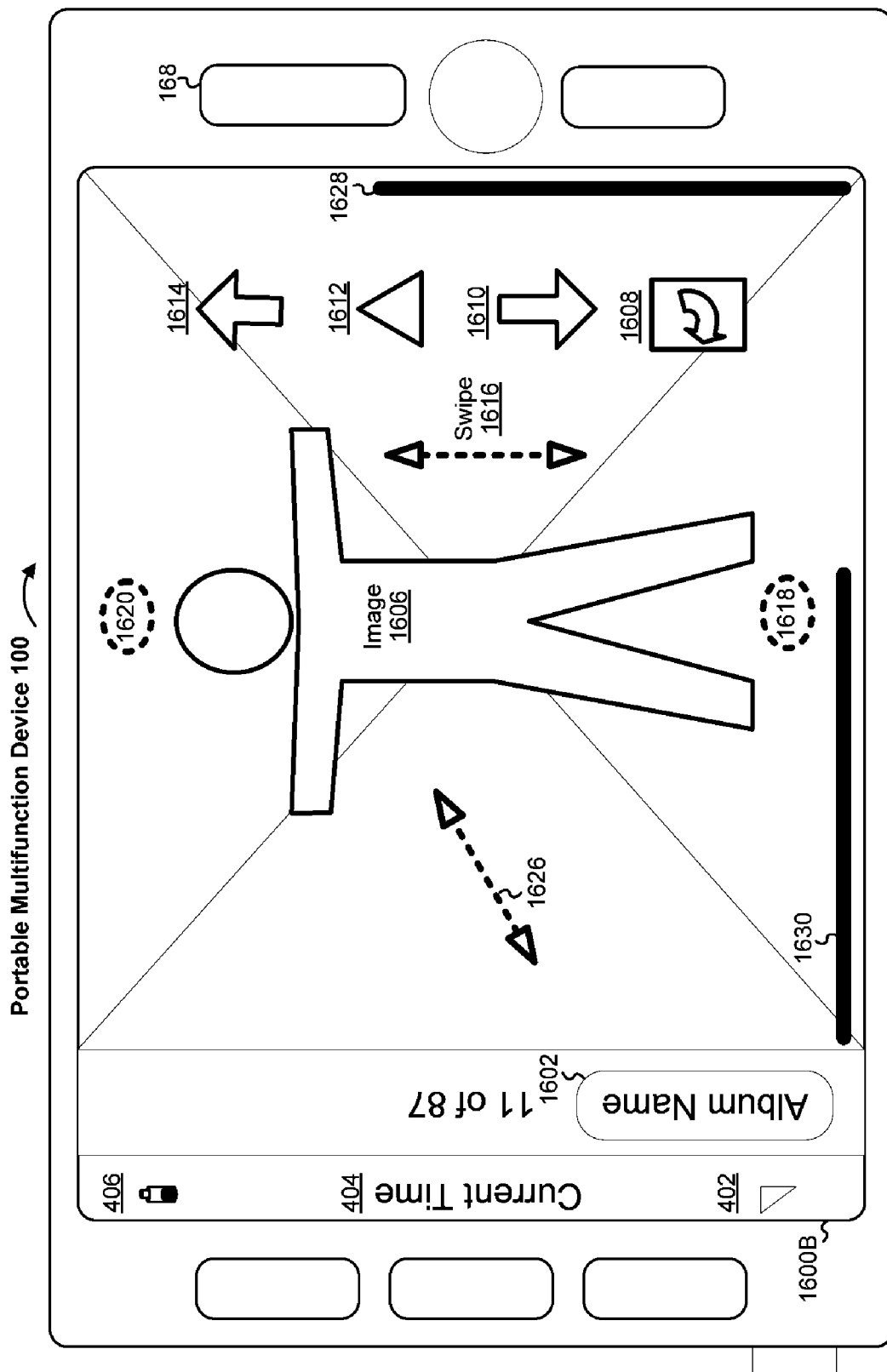

Figure 16B

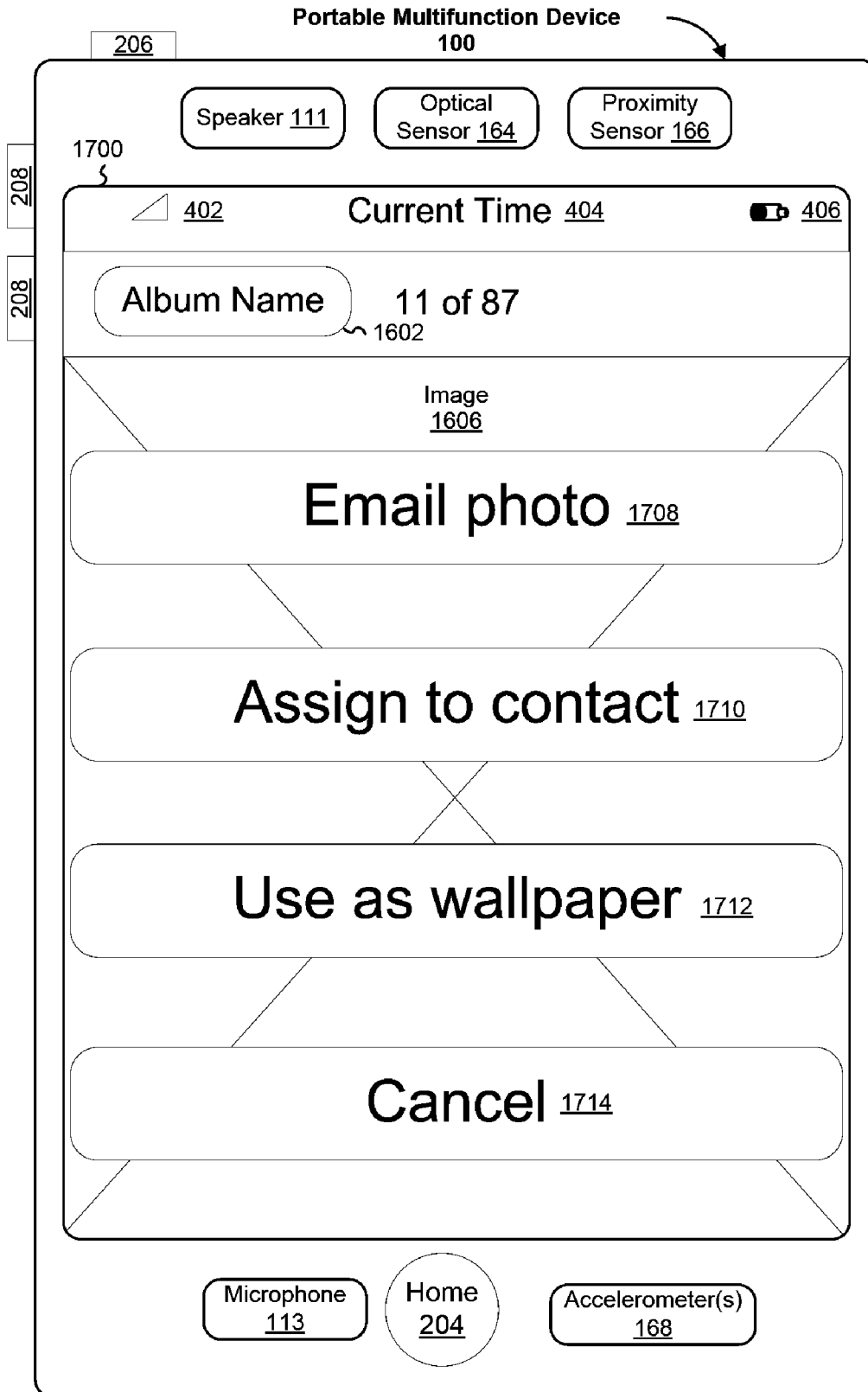

Figure 17

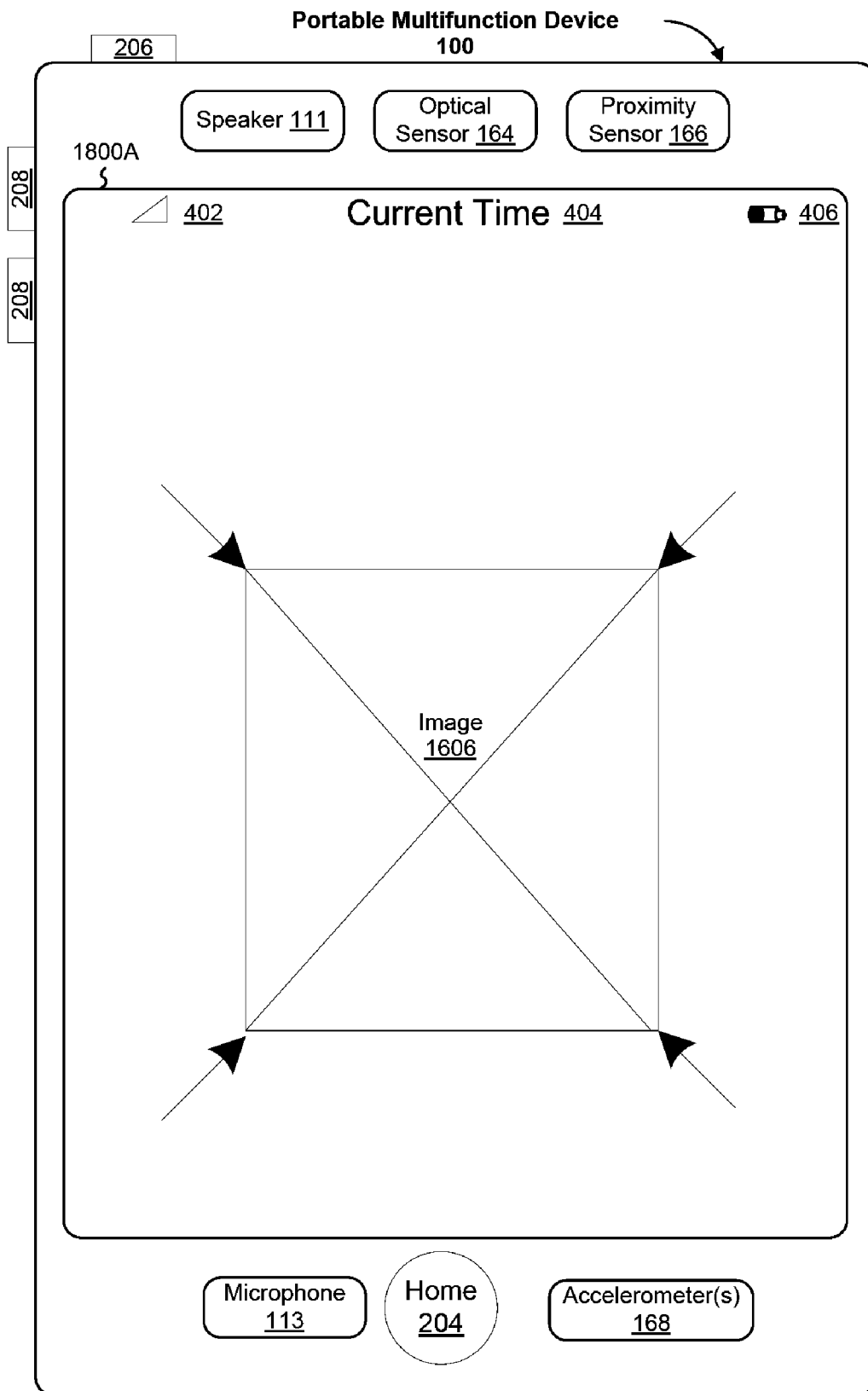

Figure 18A



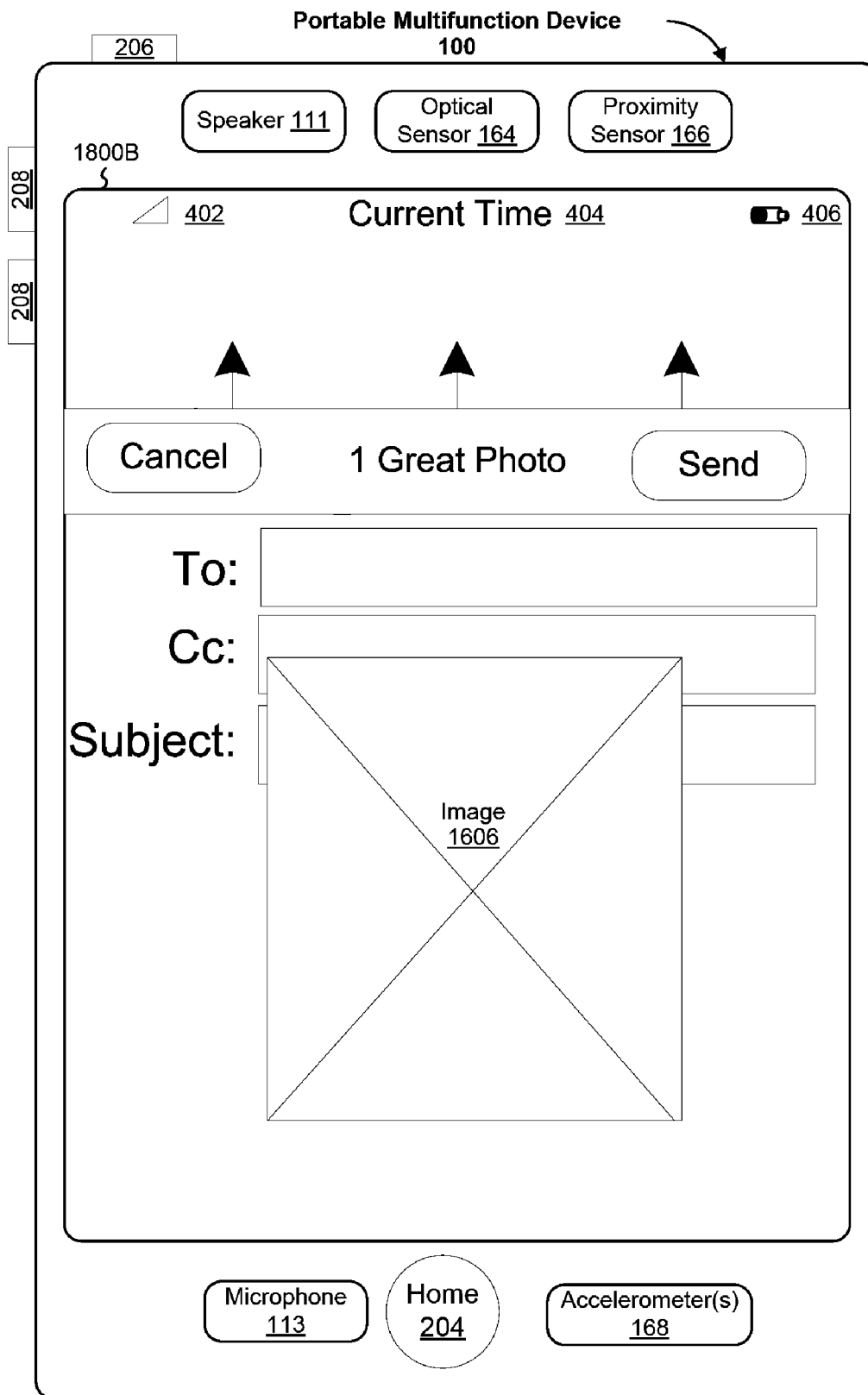

Figure 18B

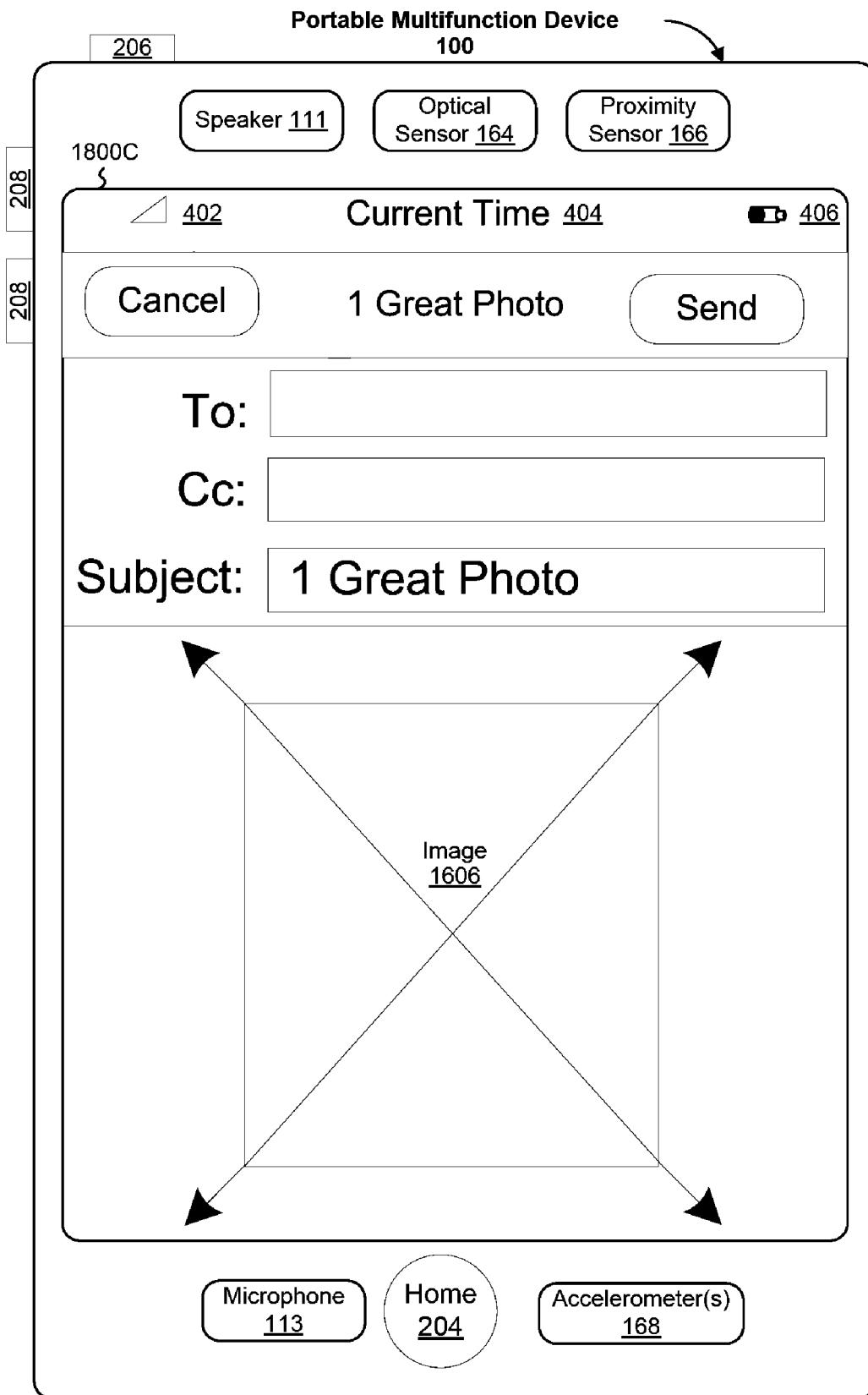

Figure 18C

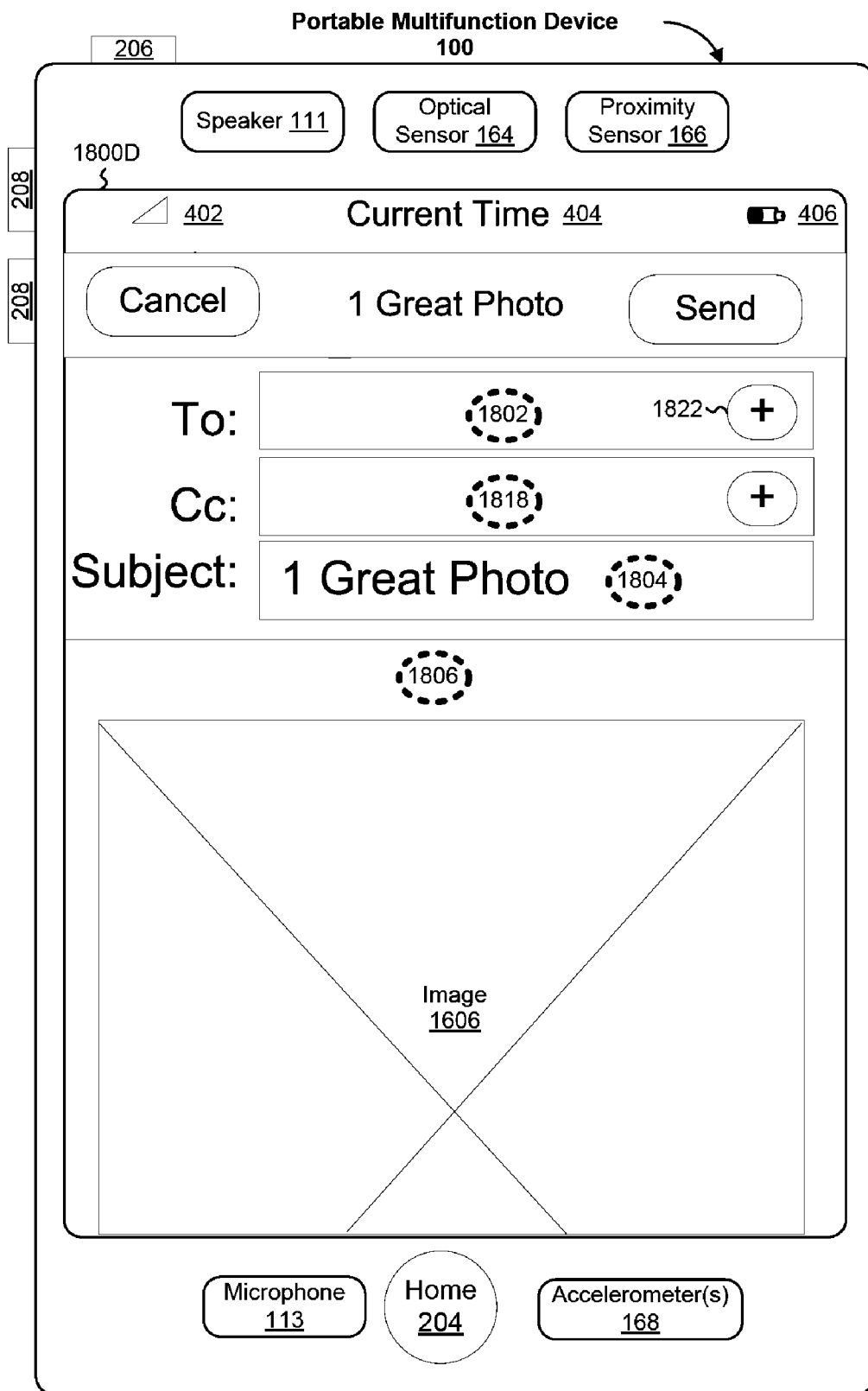

Figure 18D

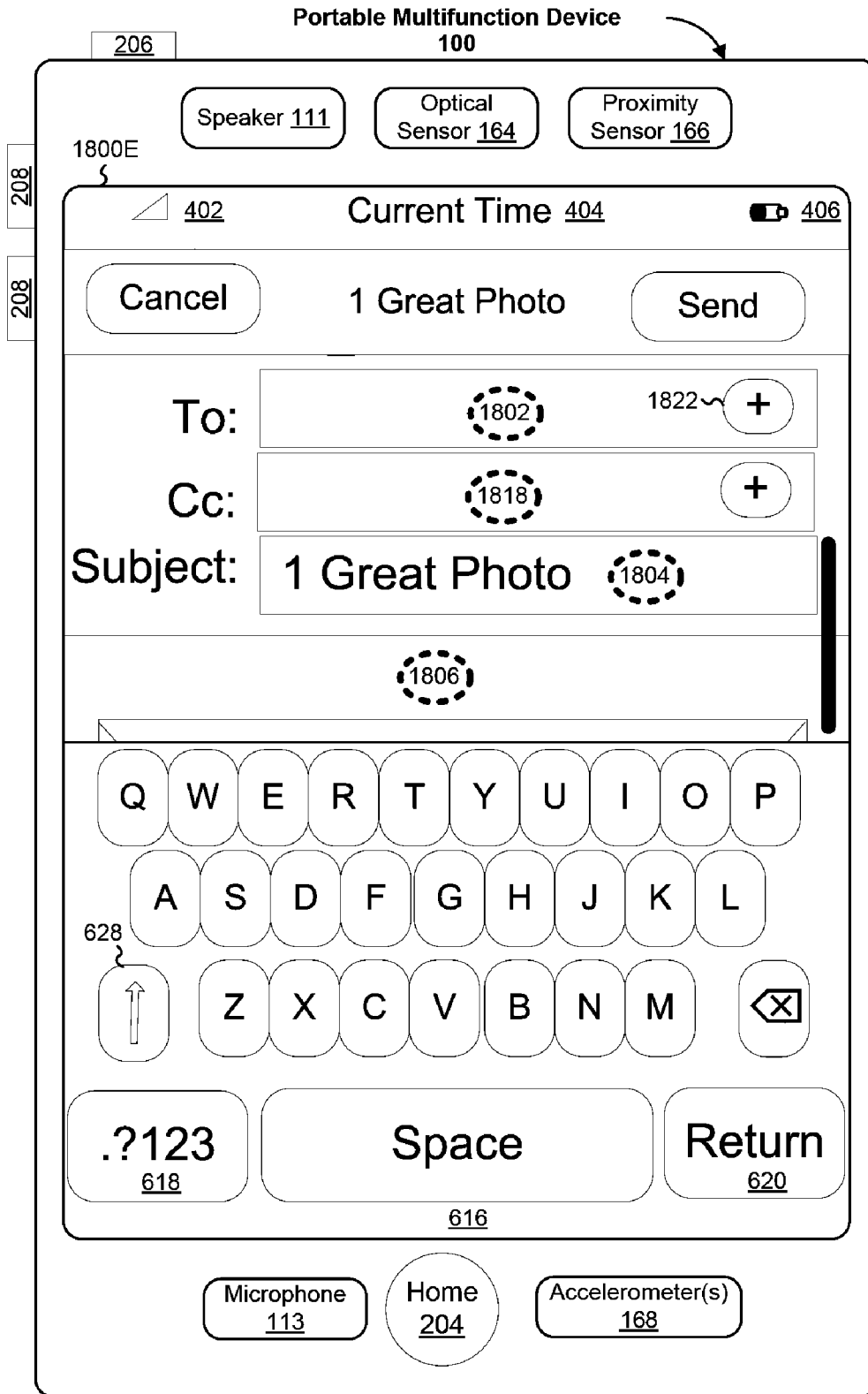

Figure 18E

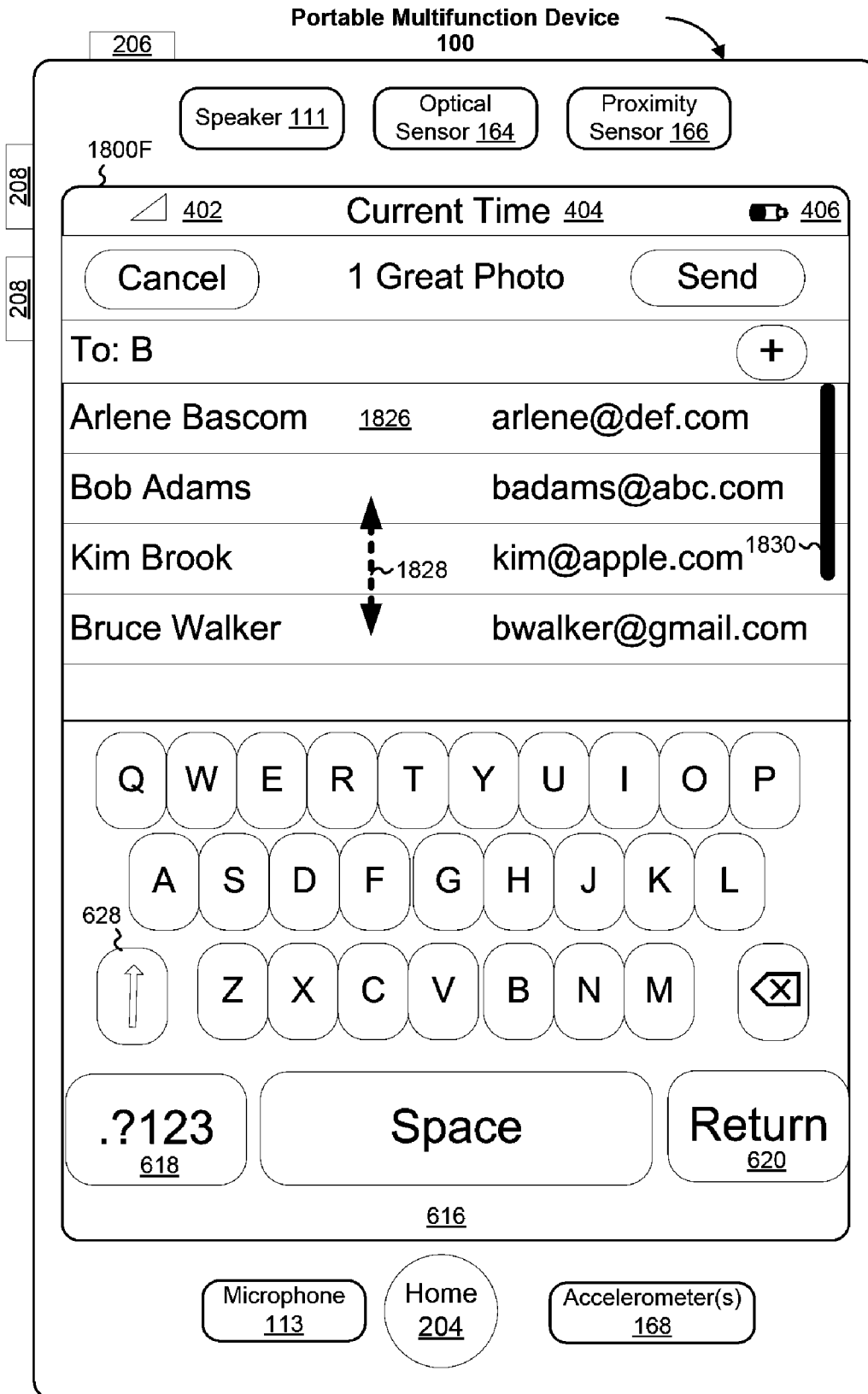

Figure 18F



Figure 18G

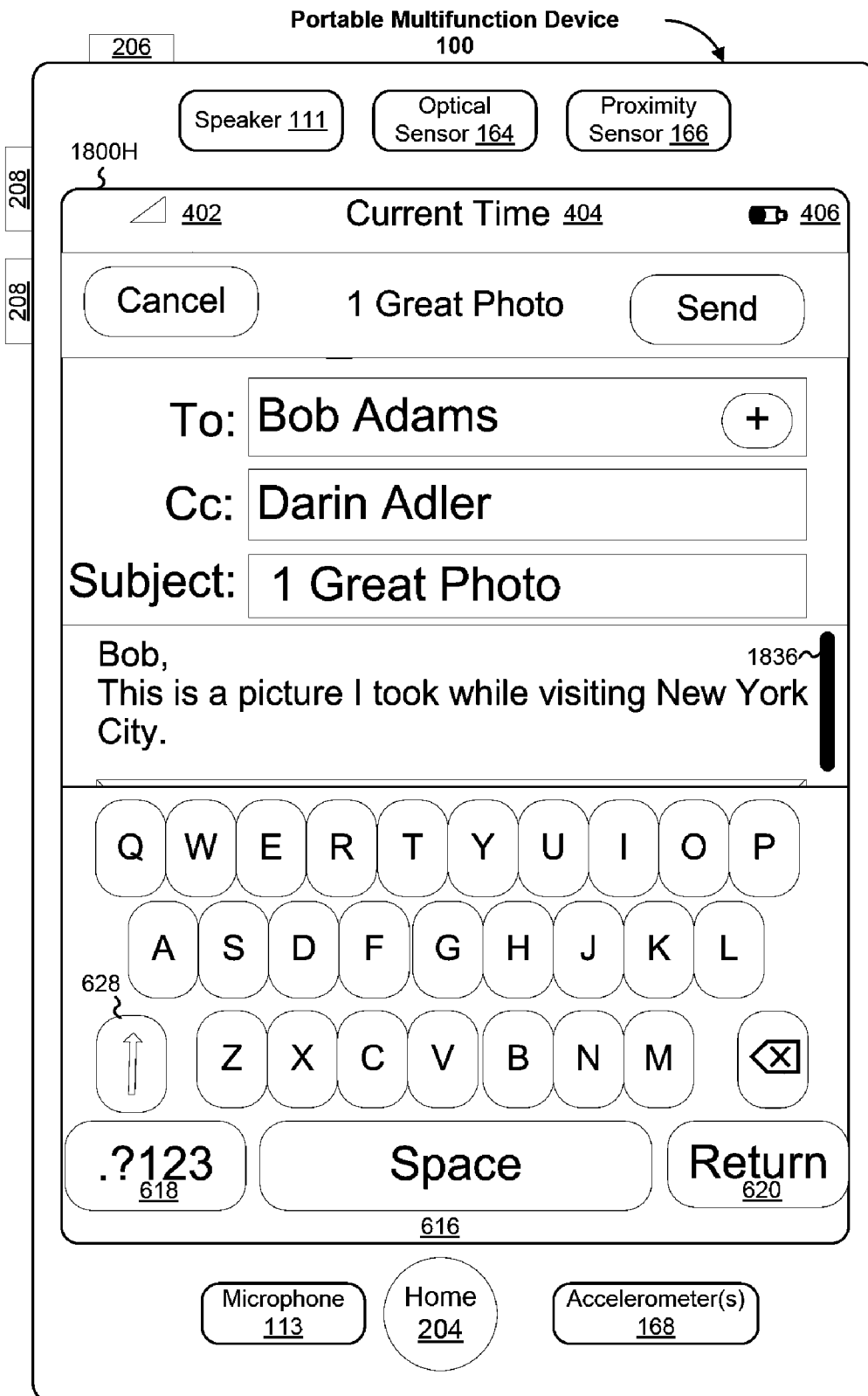

Figure 18H

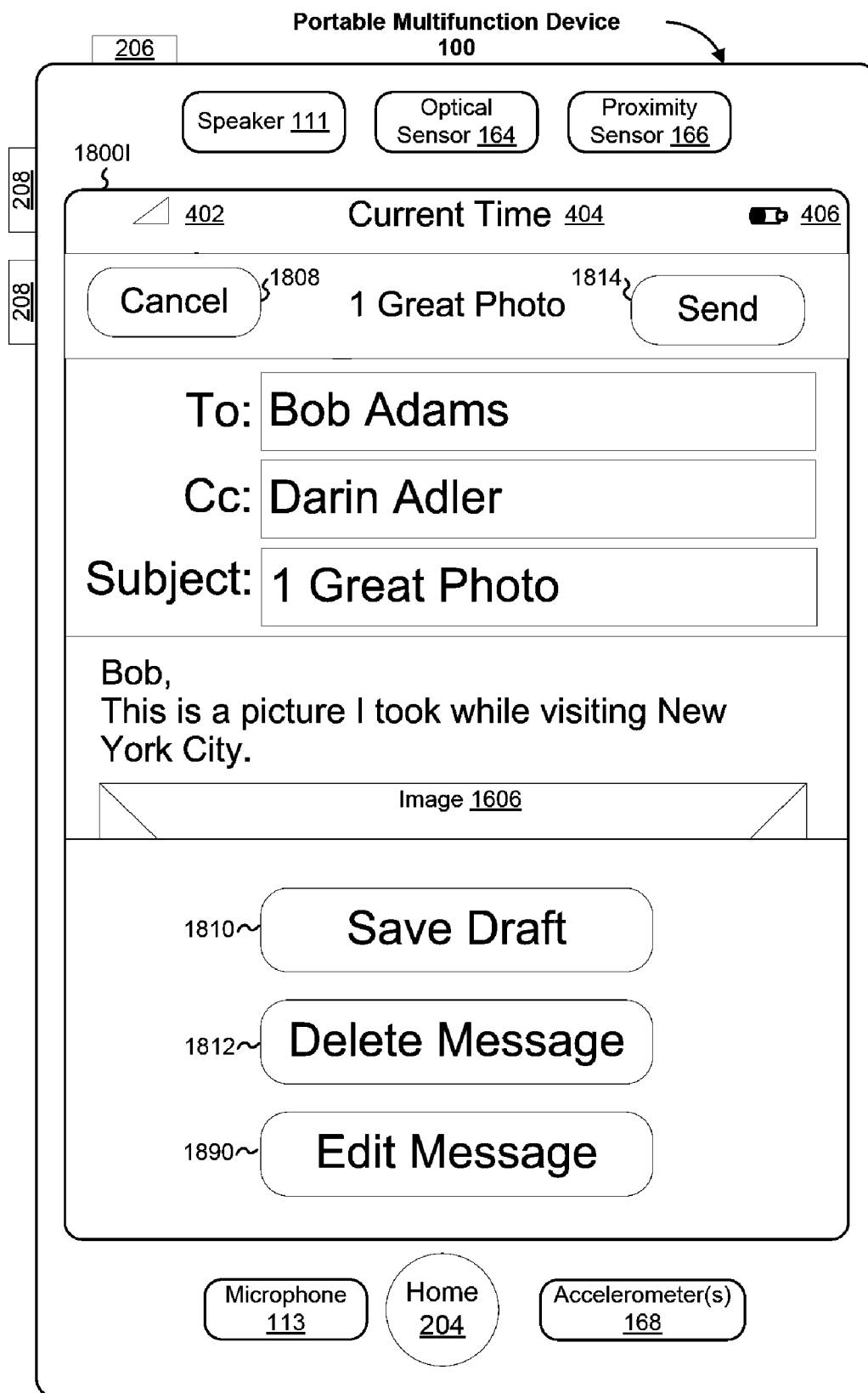

Figure 181



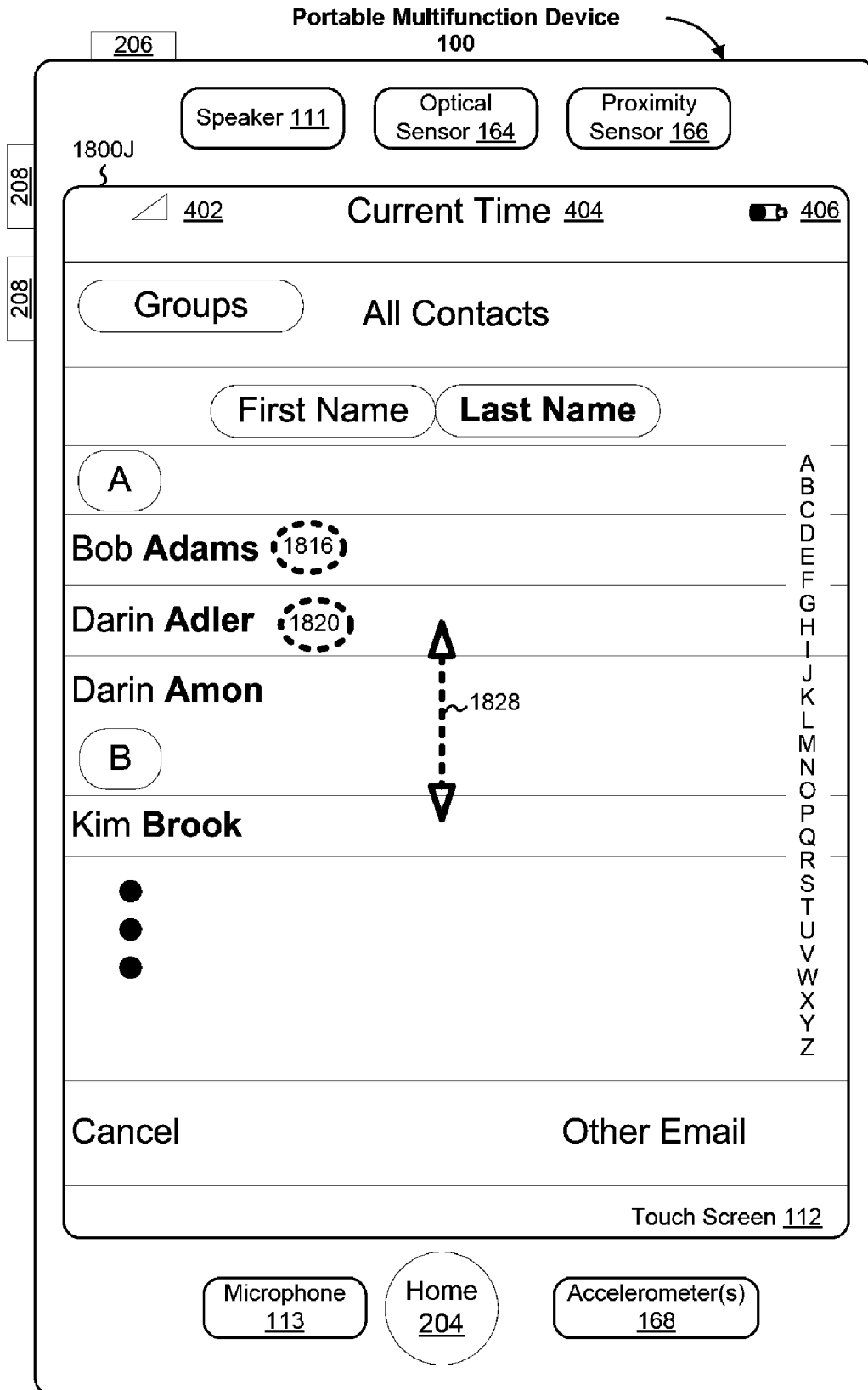

Figure 18J

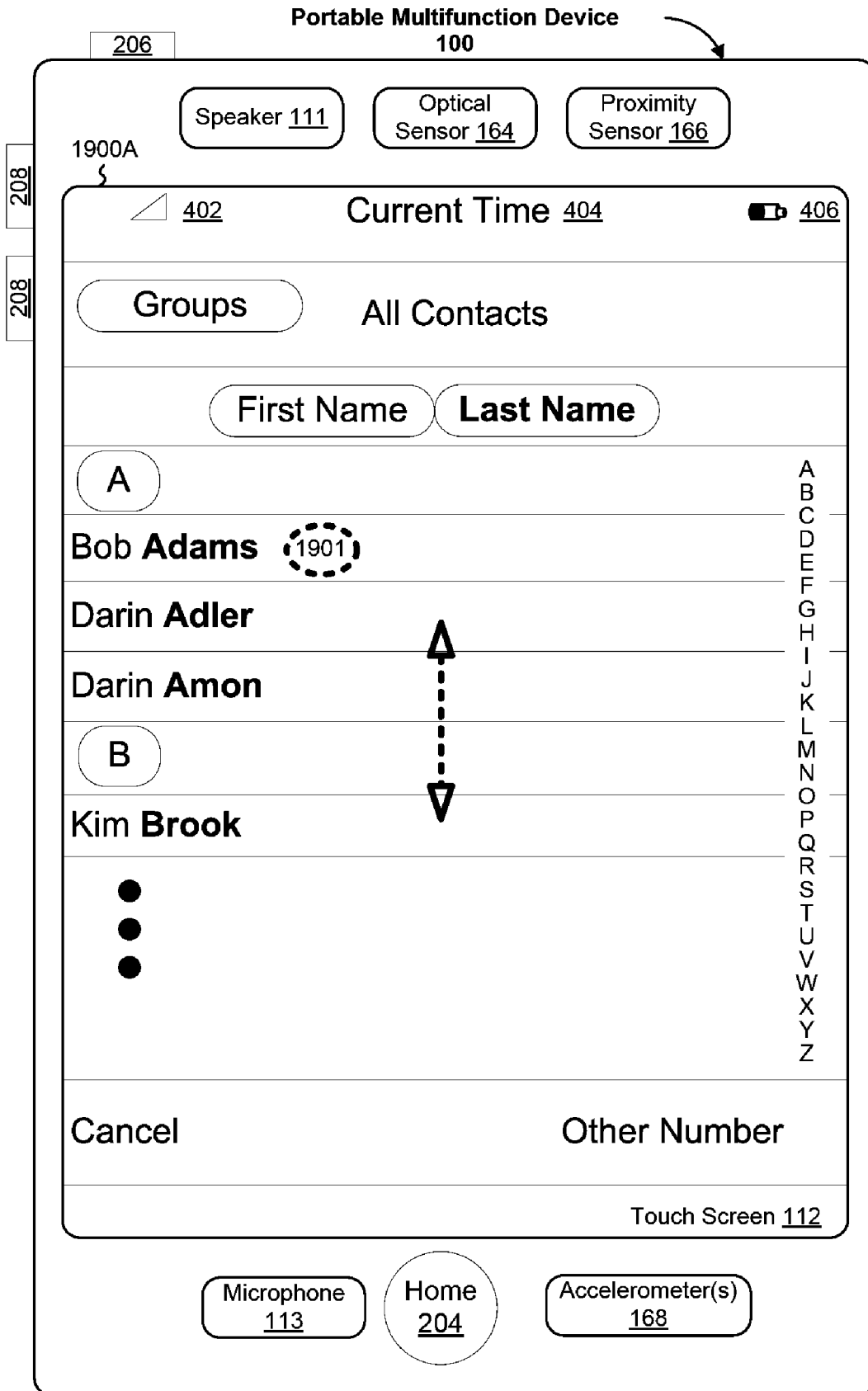

Figure 19A

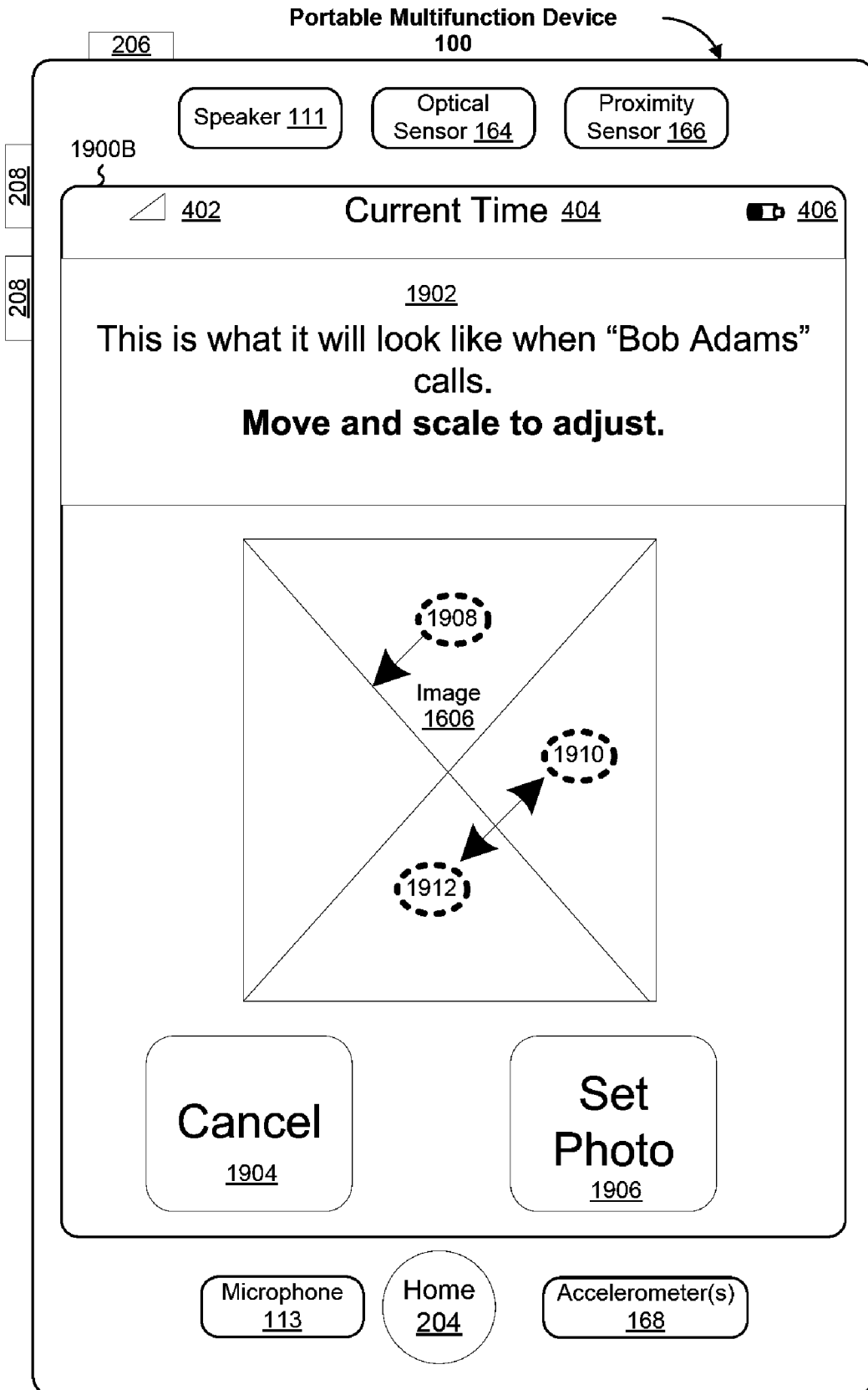

Figure 19B

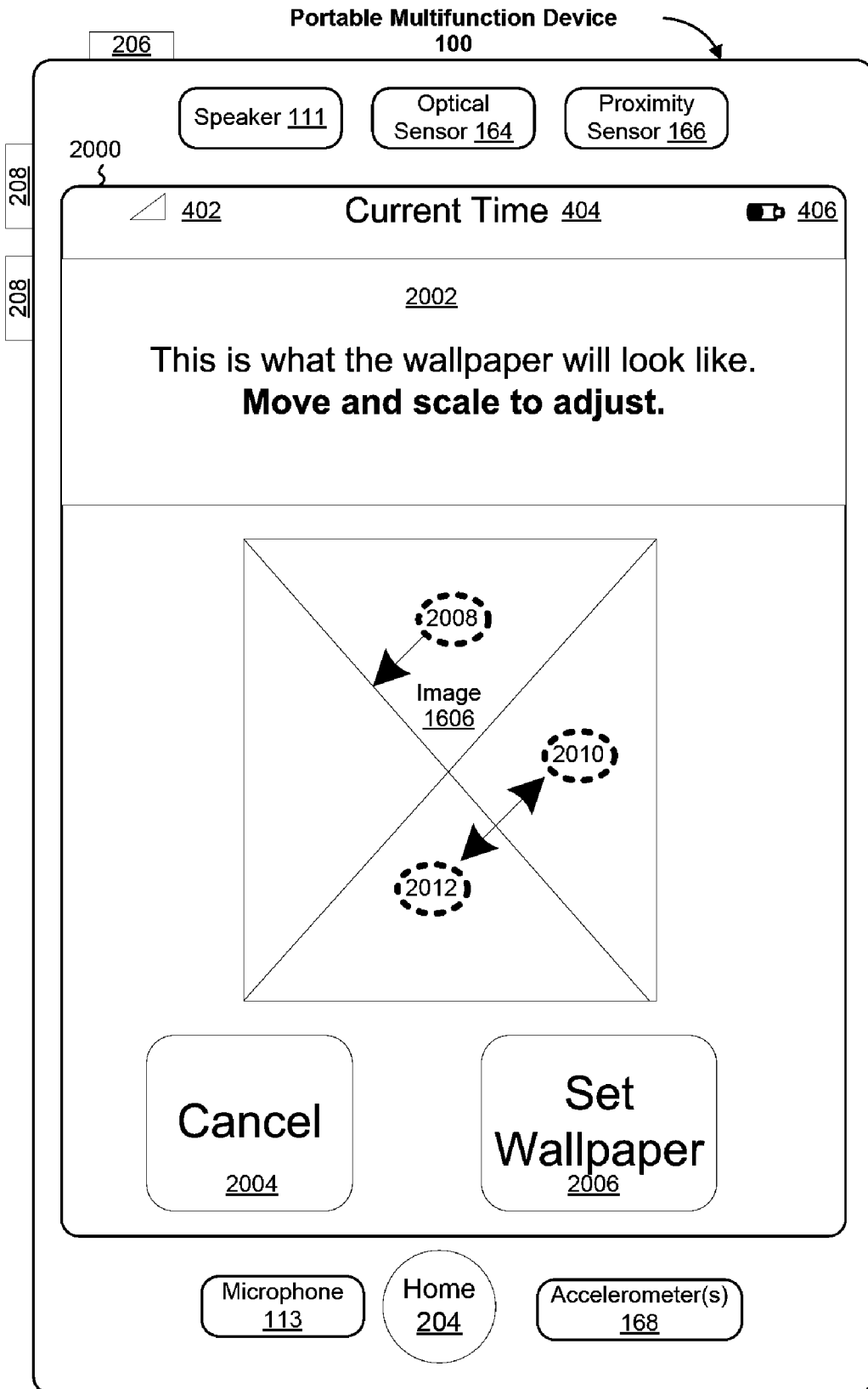

Figure 20

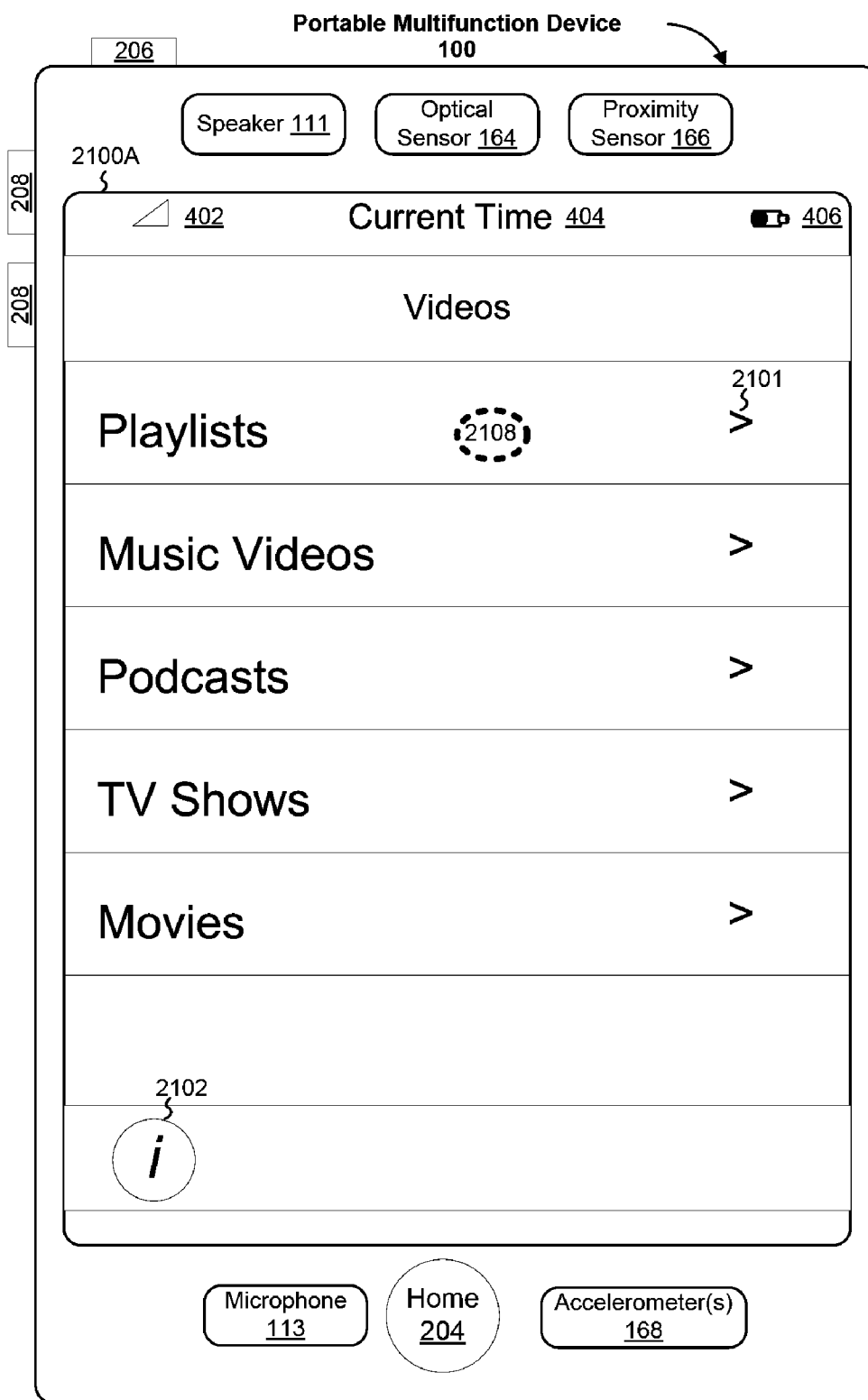

Figure 21A

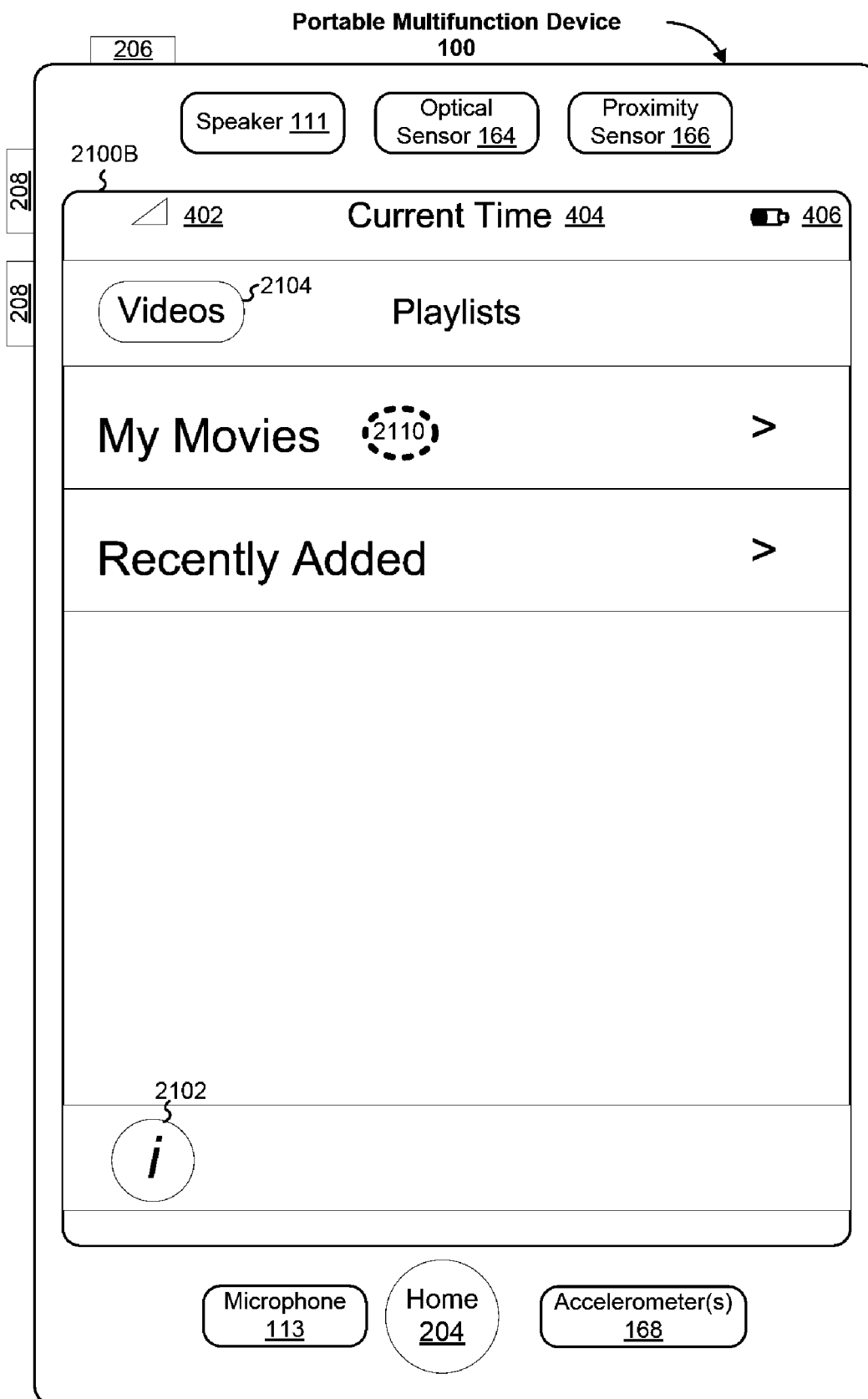

Figure 21B

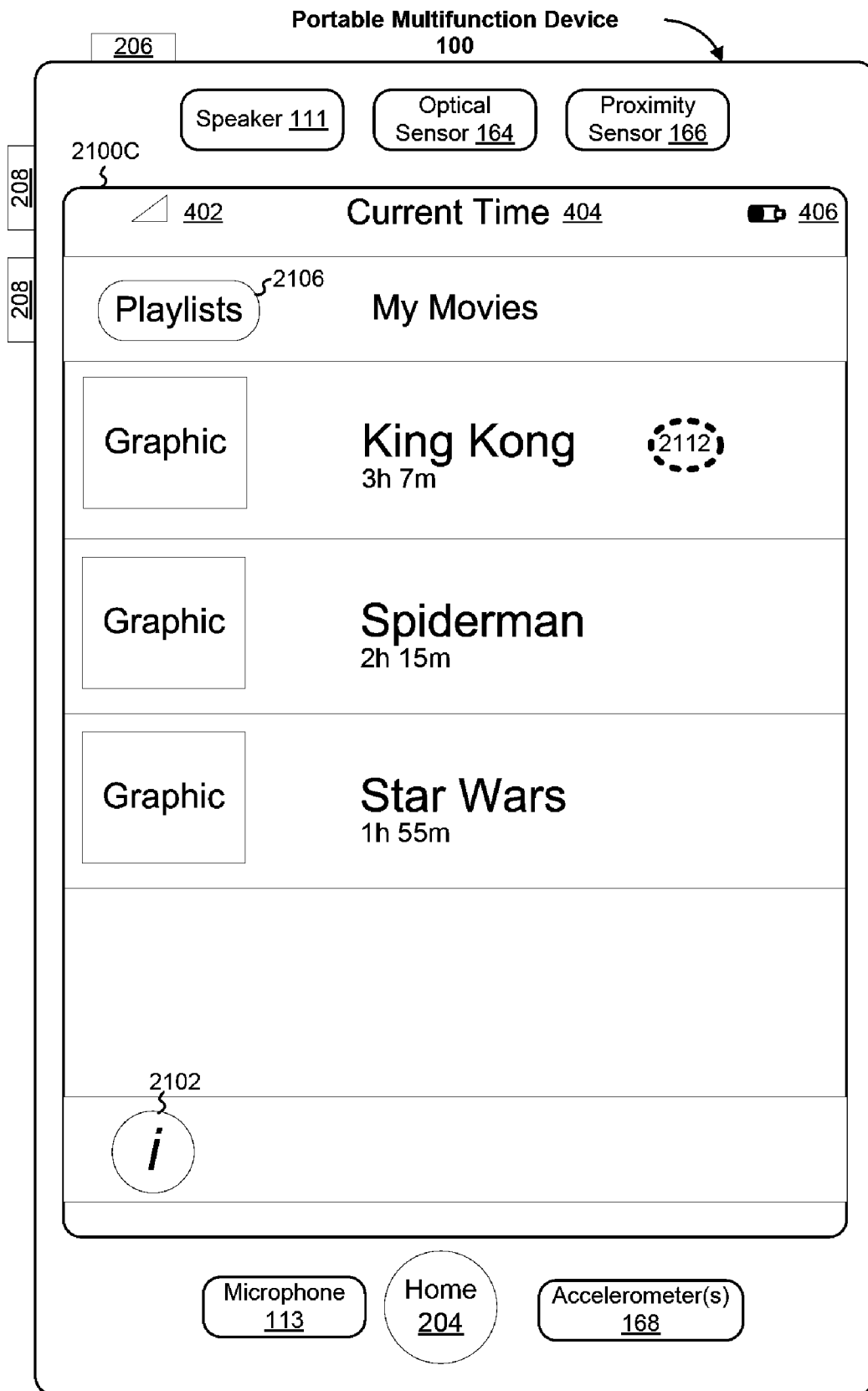

Figure 21C

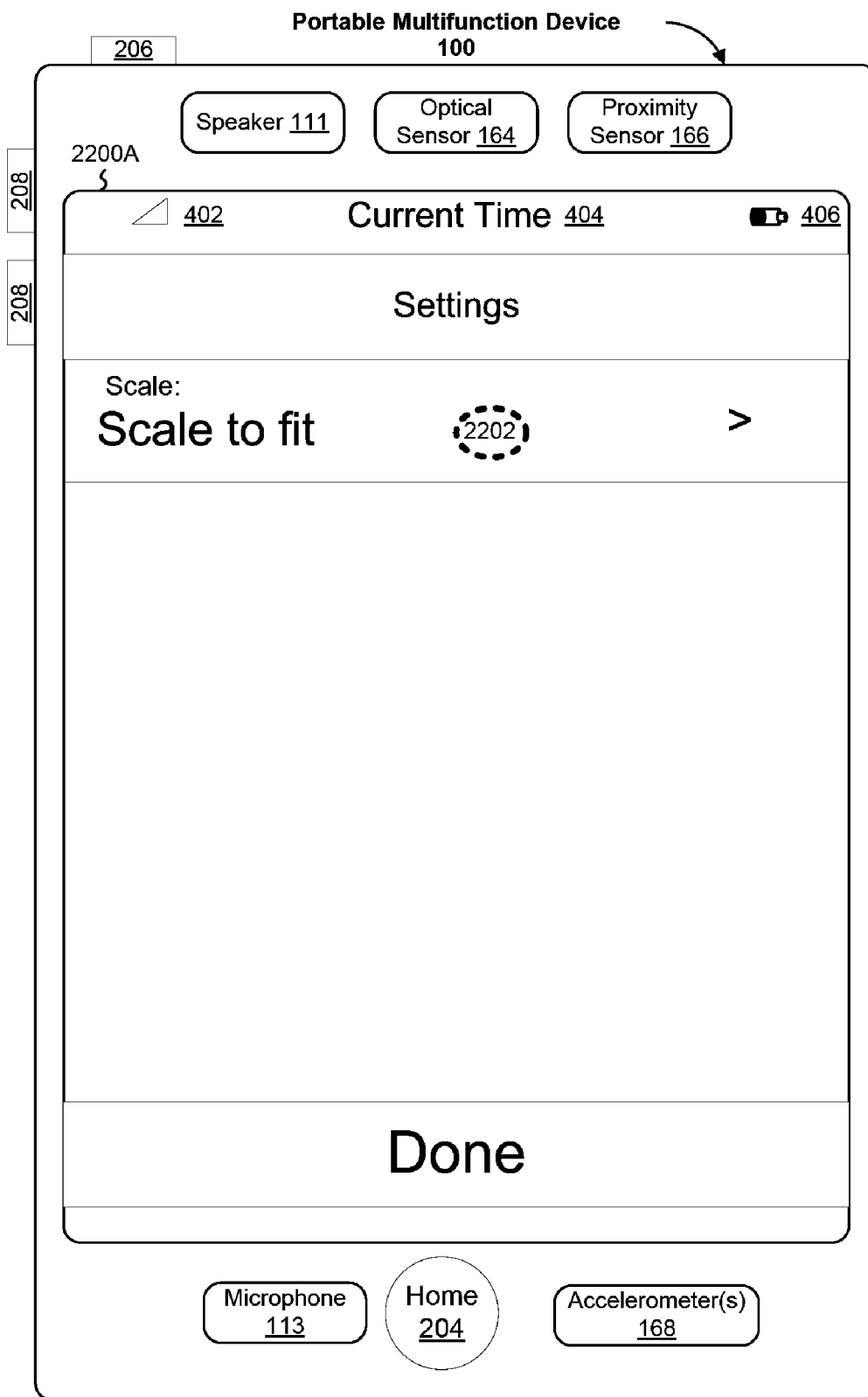

Figure 22A



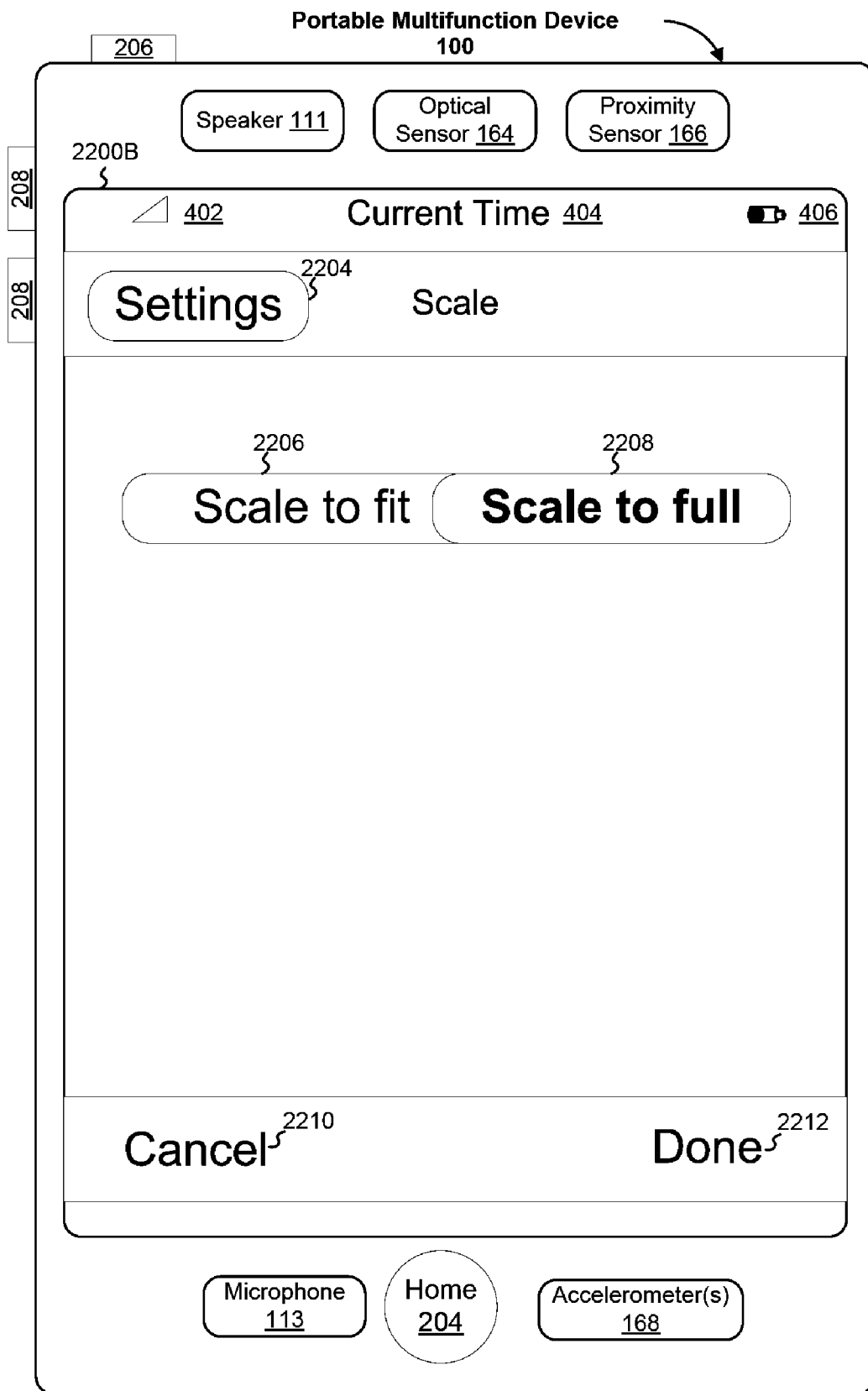

Figure 22B

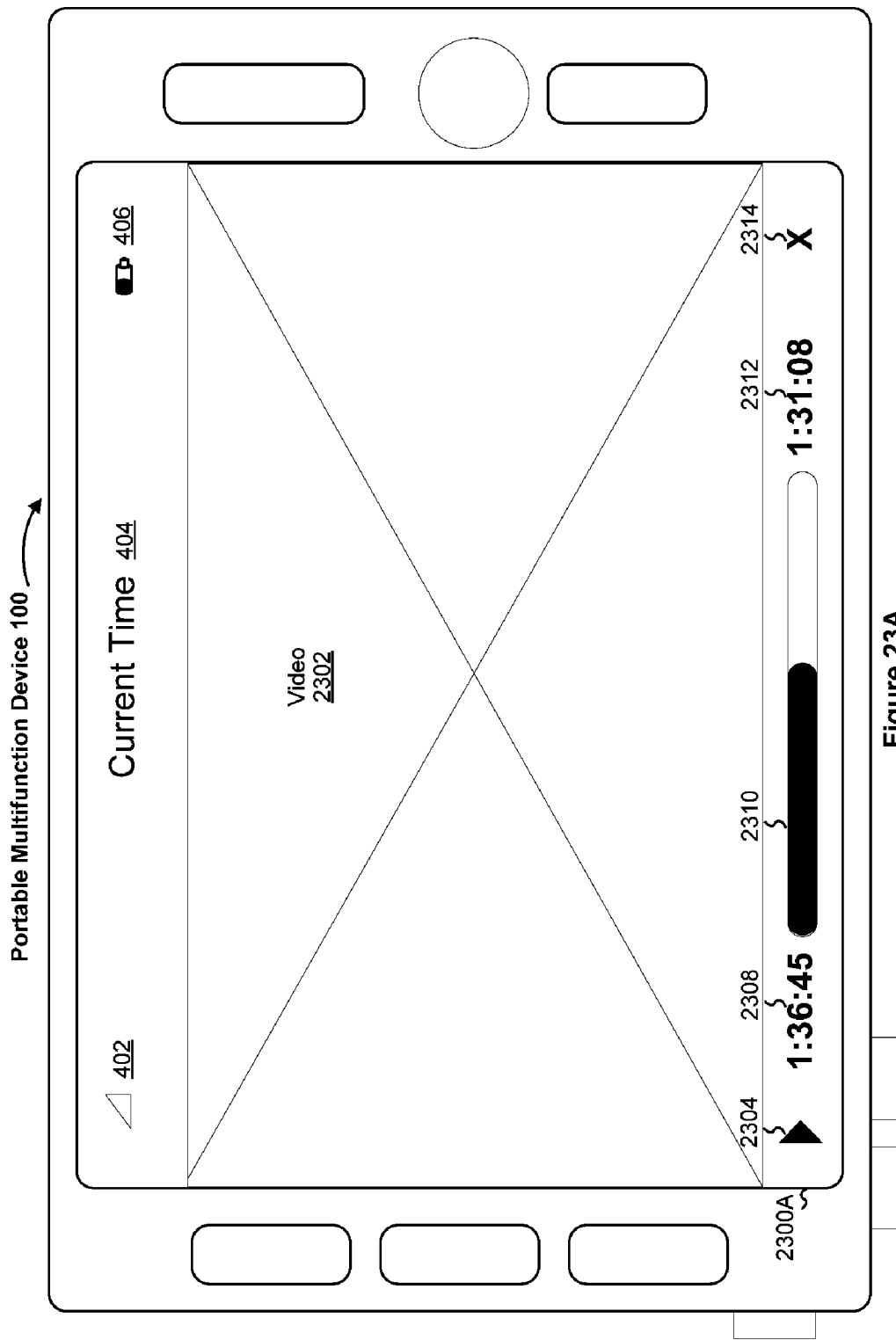

Figure 23A

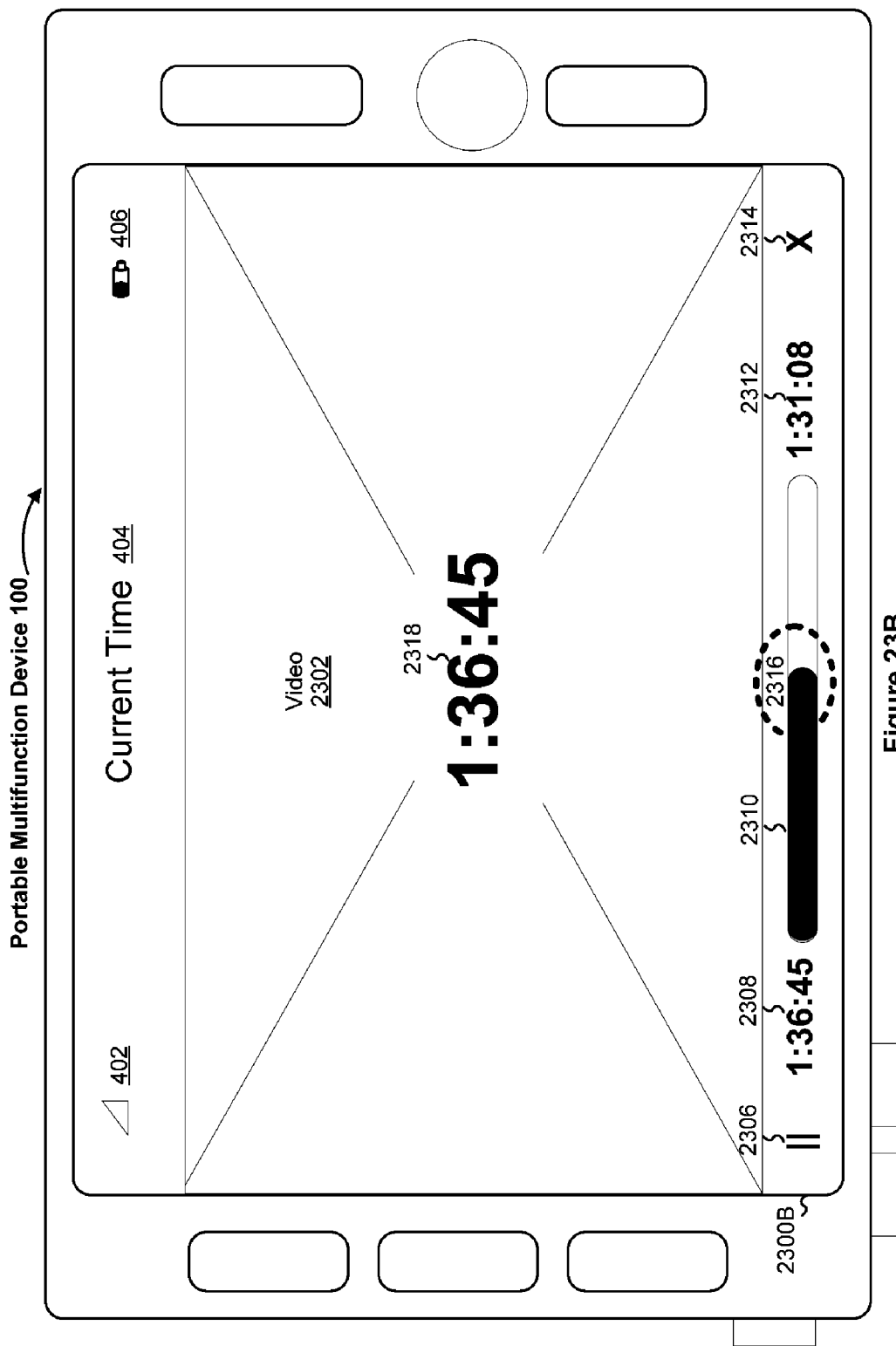

Figure 23B

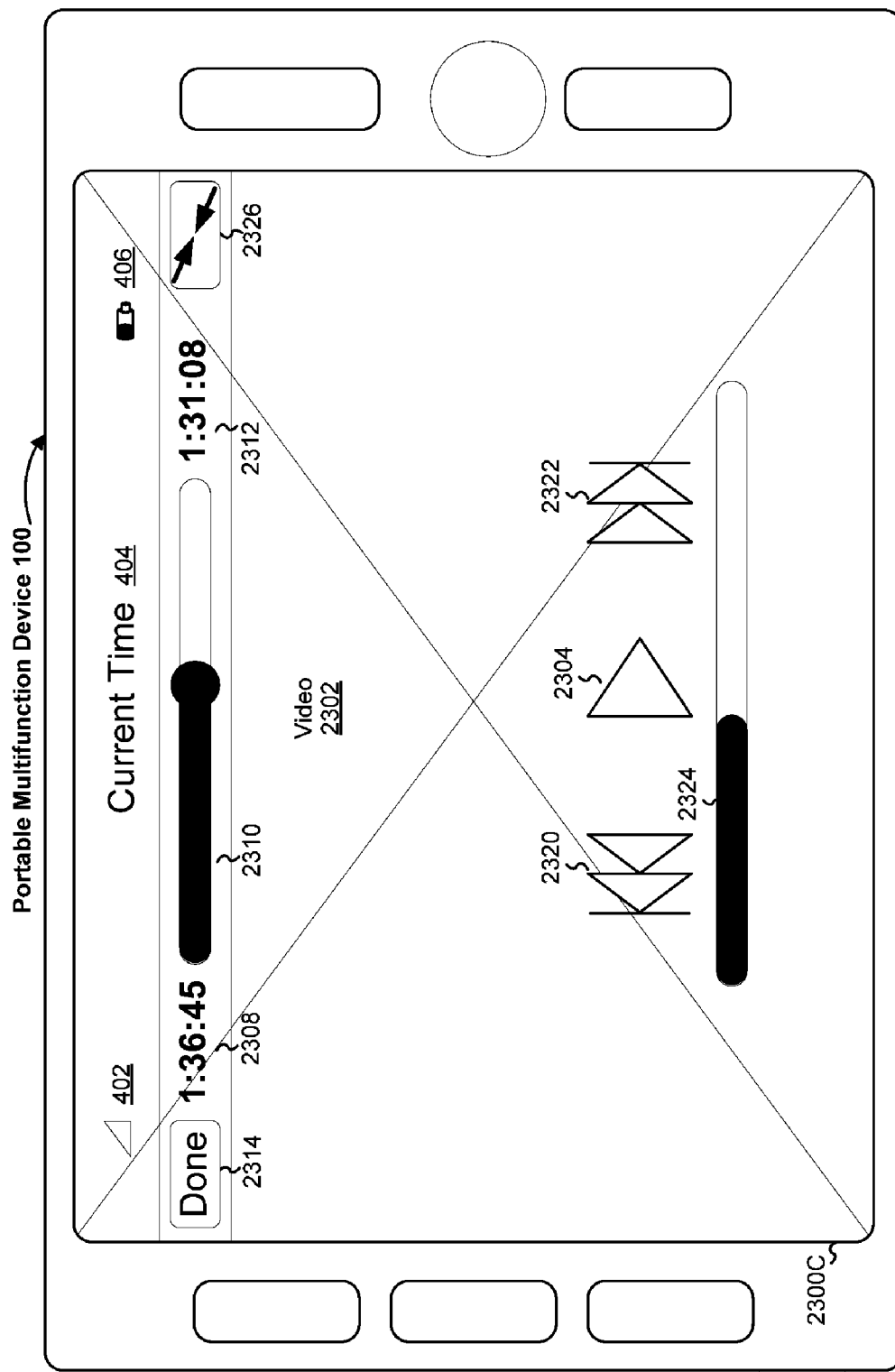

Figure 23C

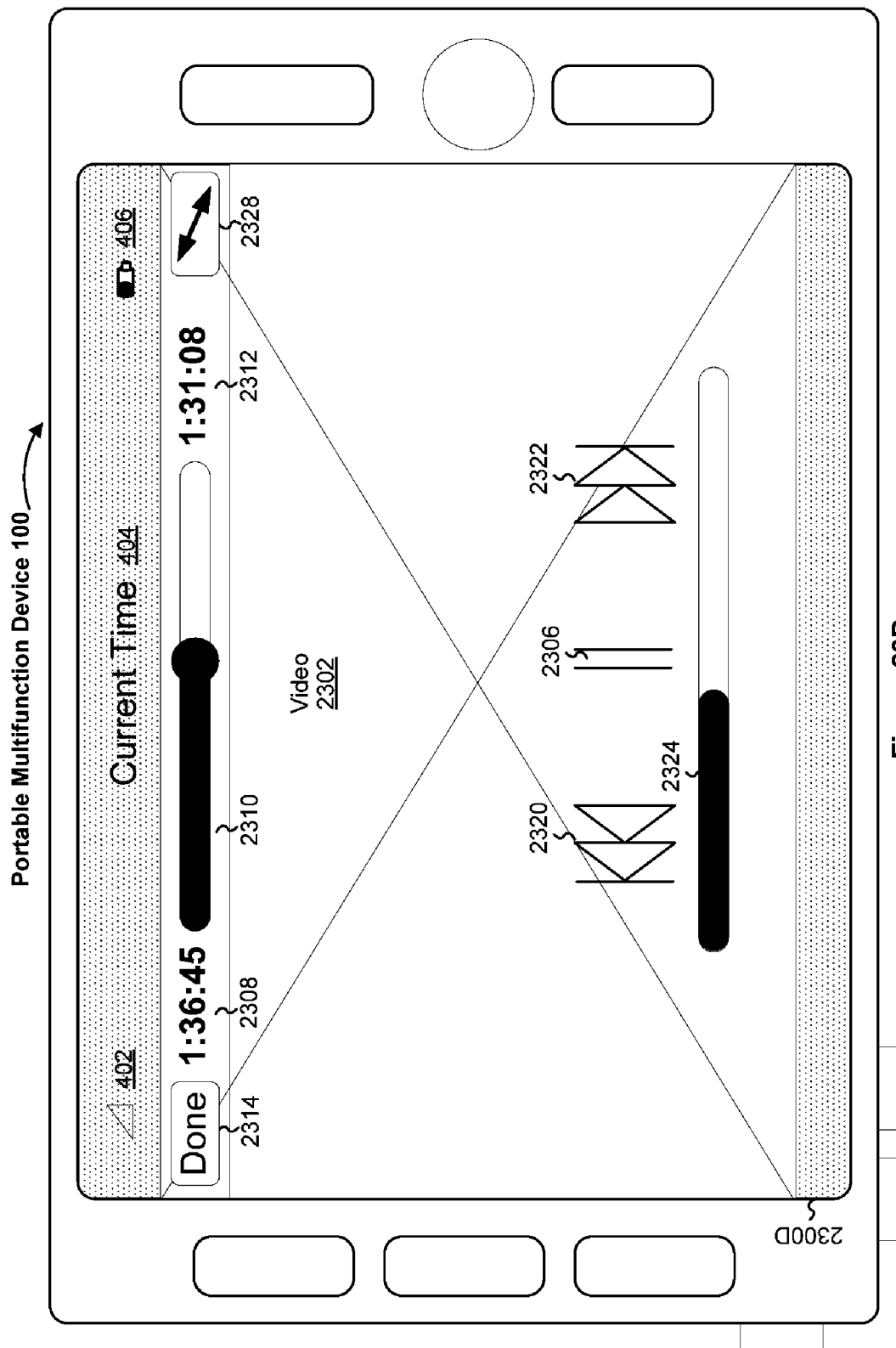

Figure 23D

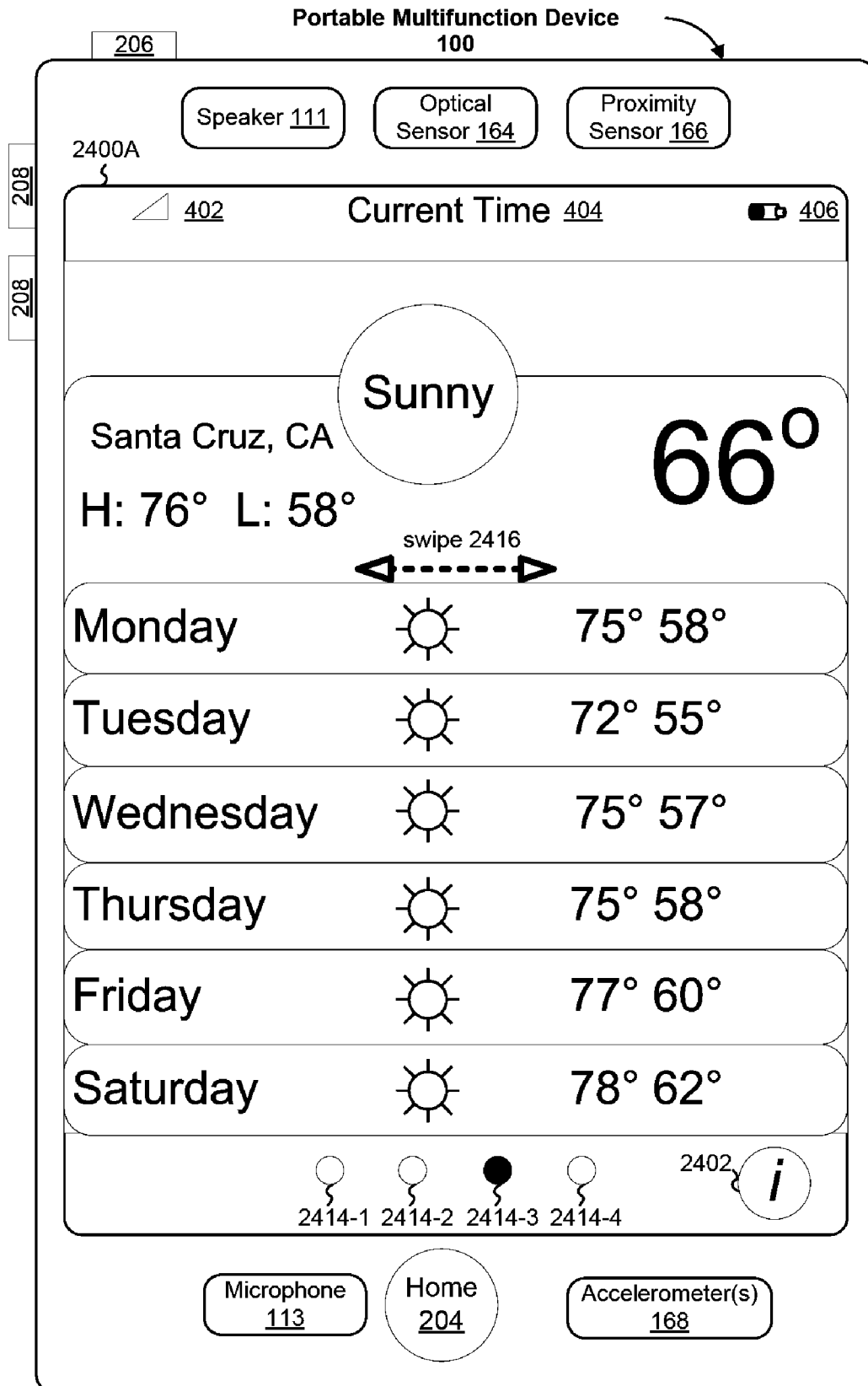

Figure 24A

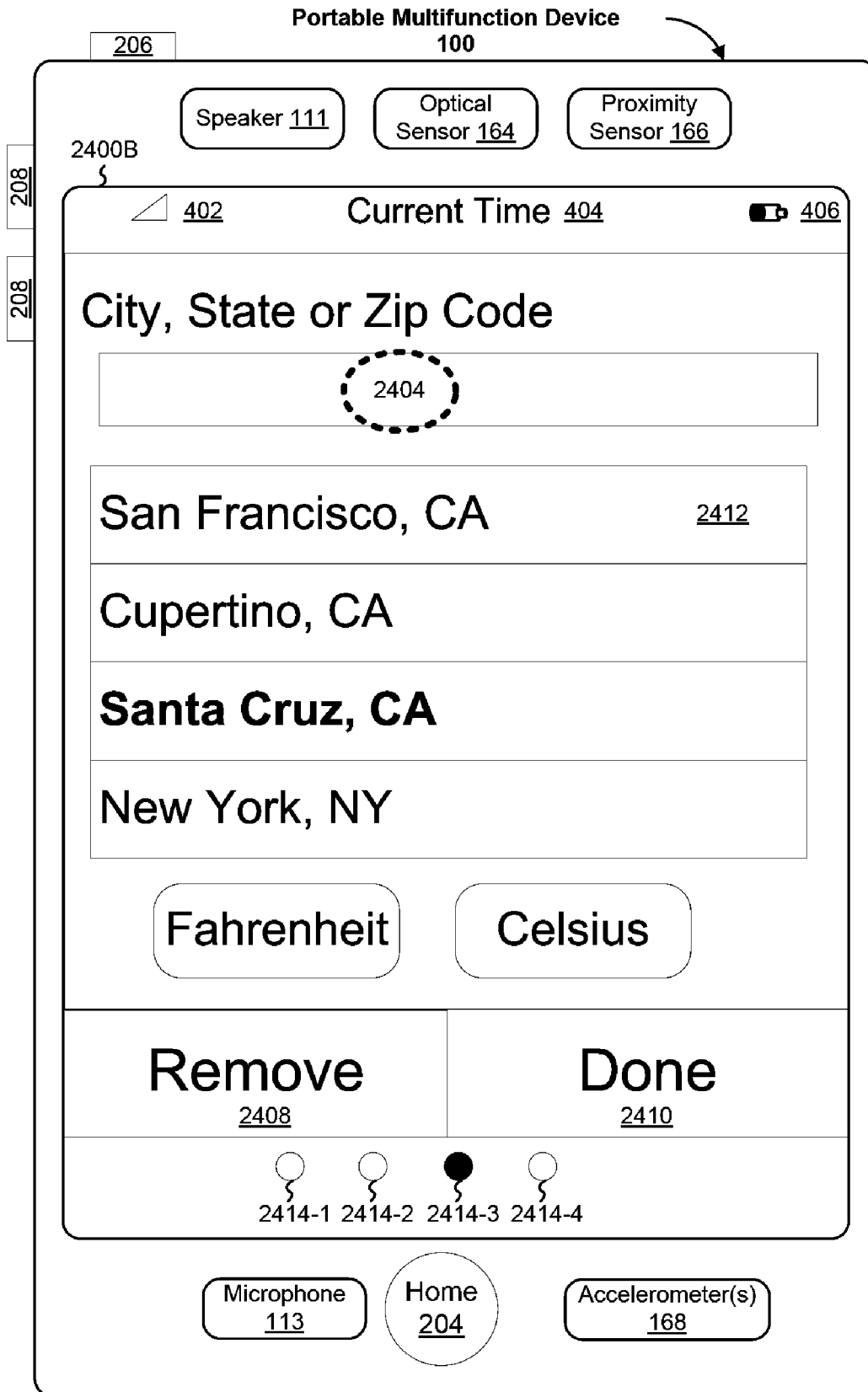

Figure 24B

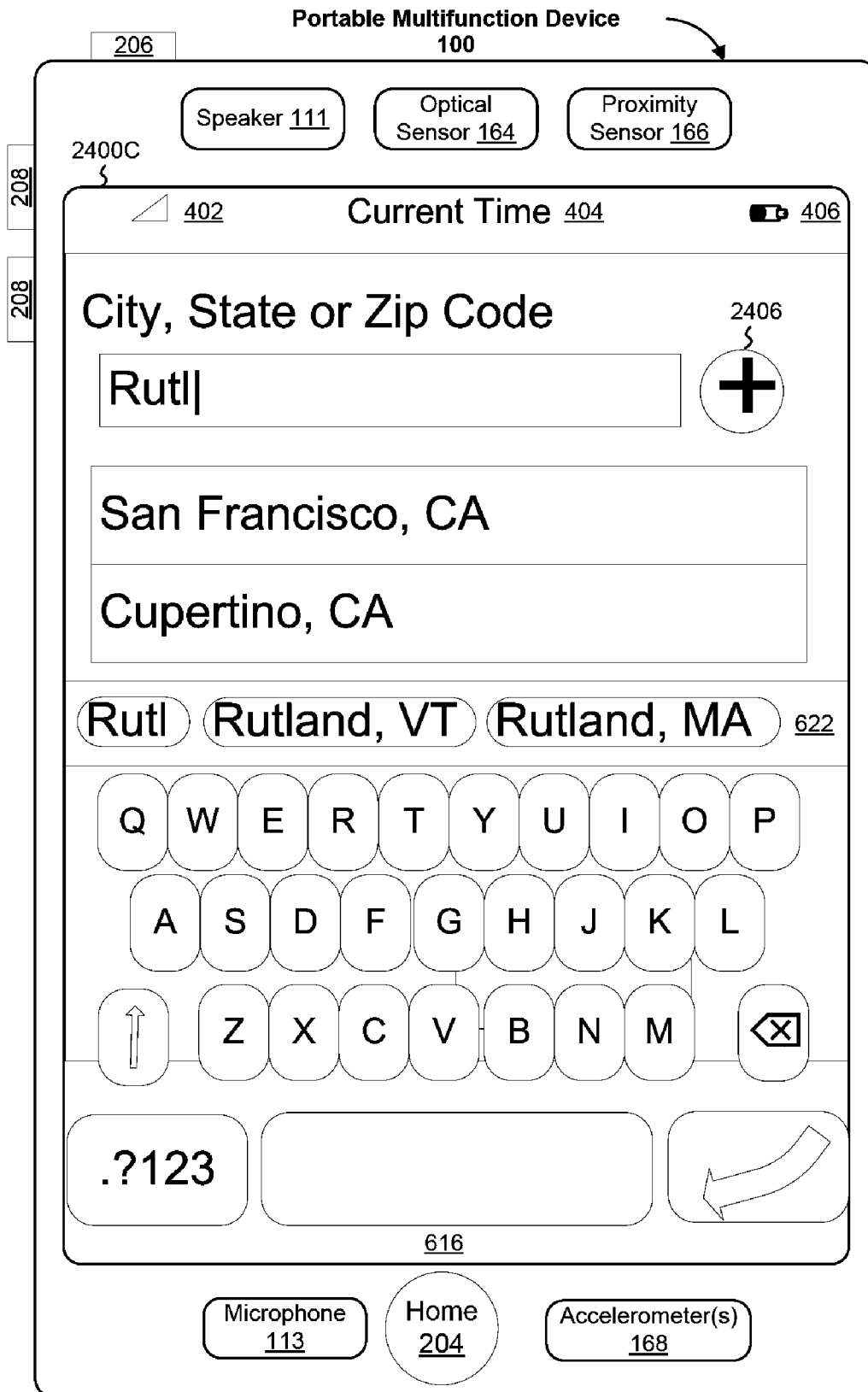

Figure 24C



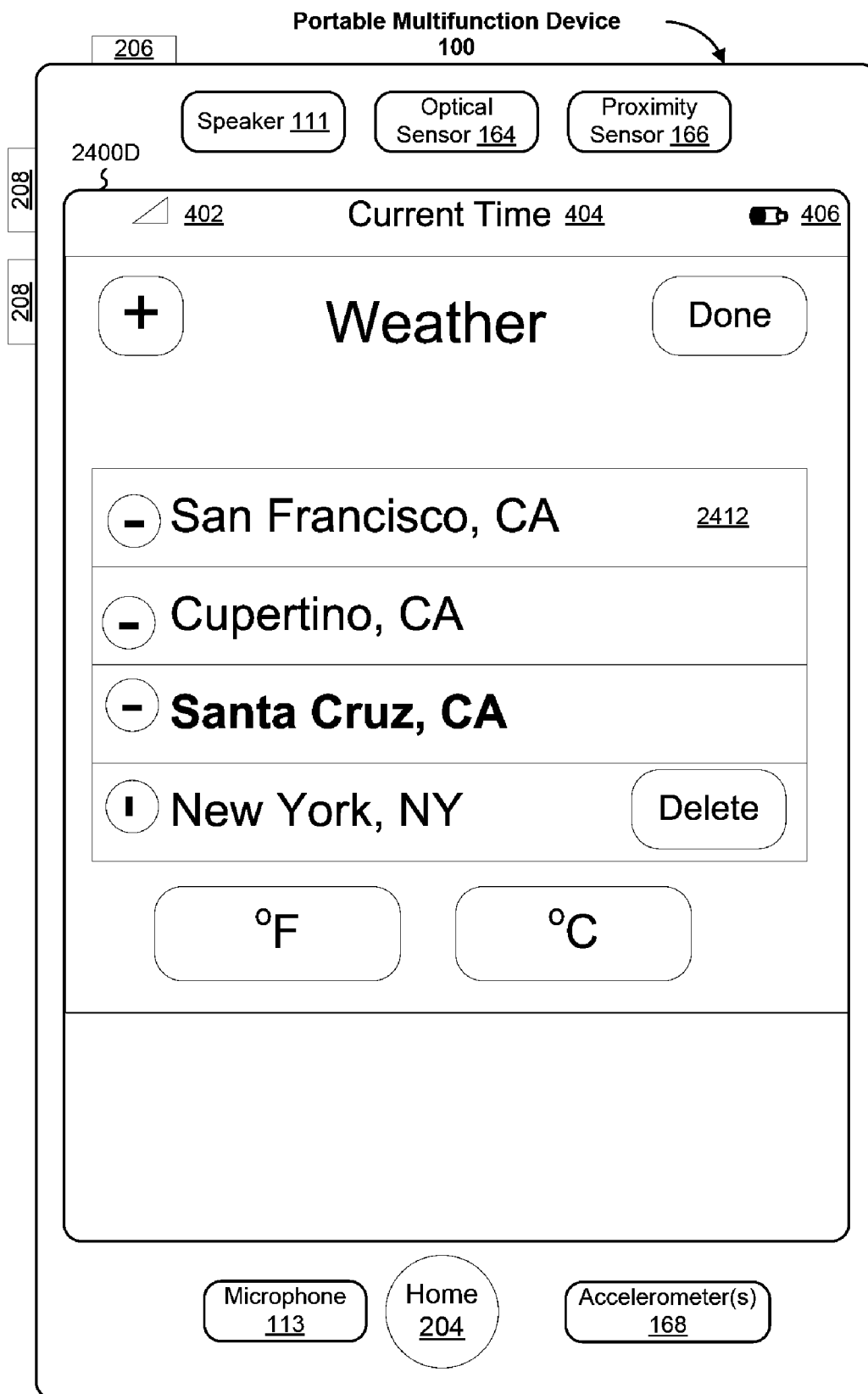

Figure 24D

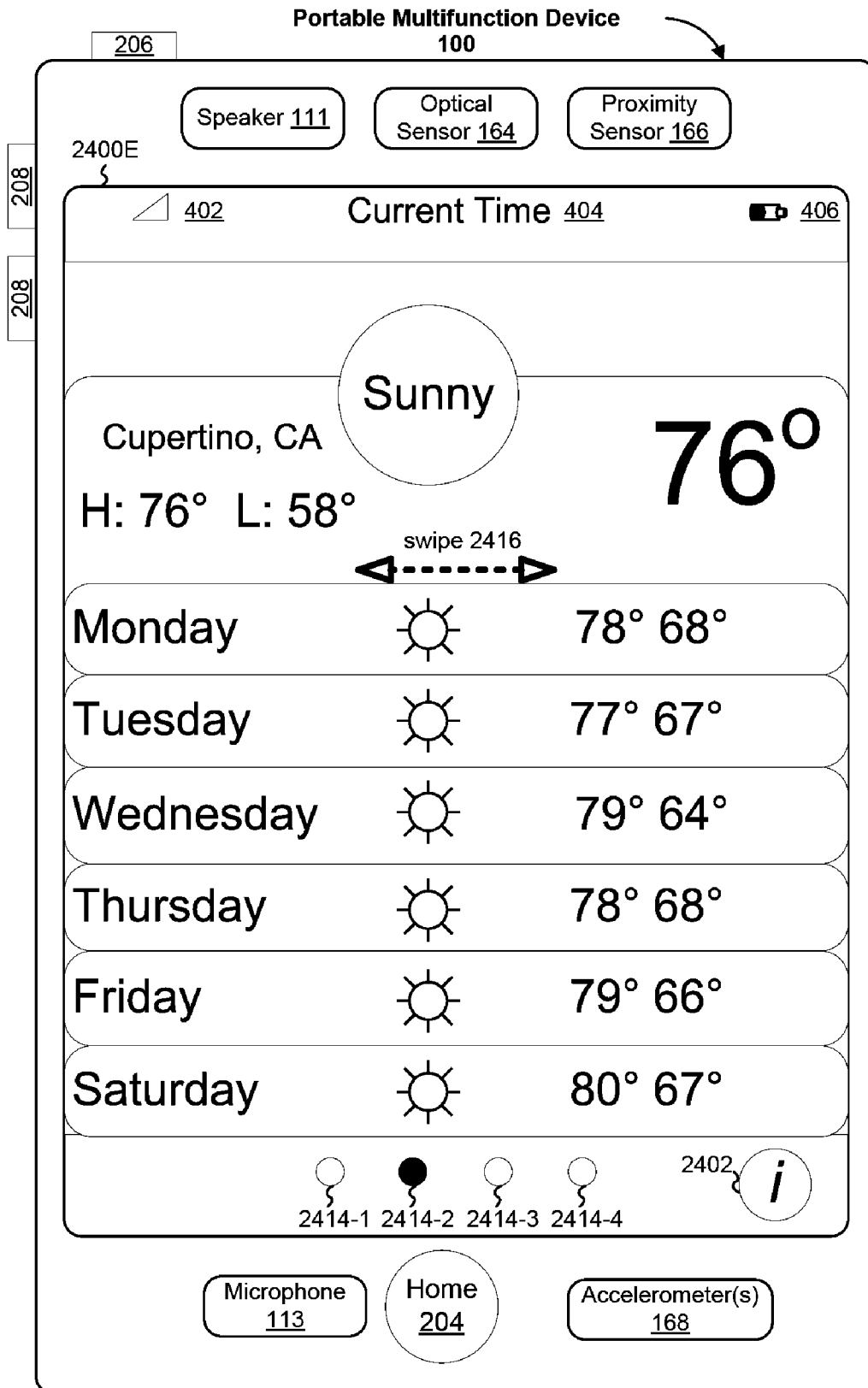

Figure 24E

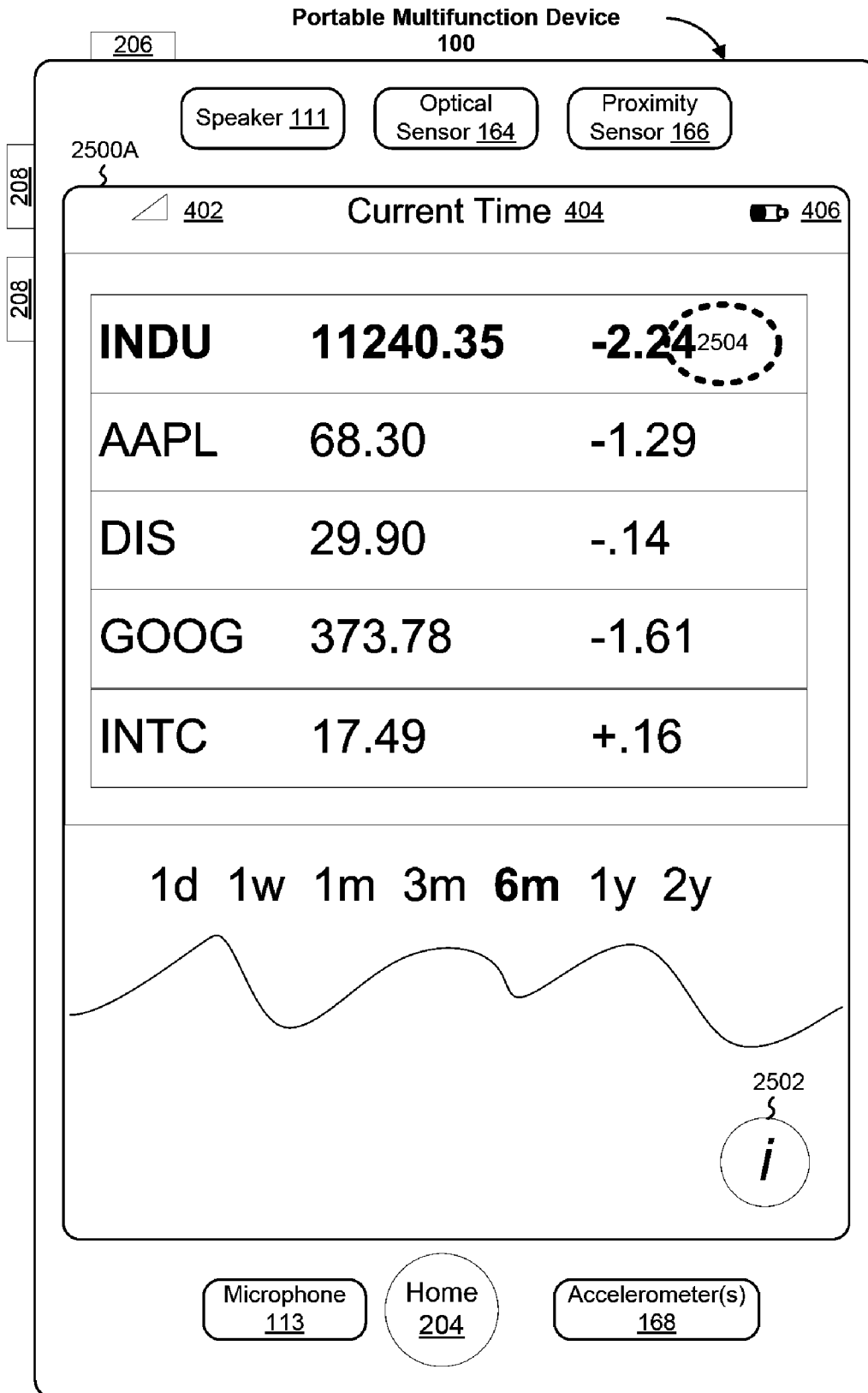

Figure 25A

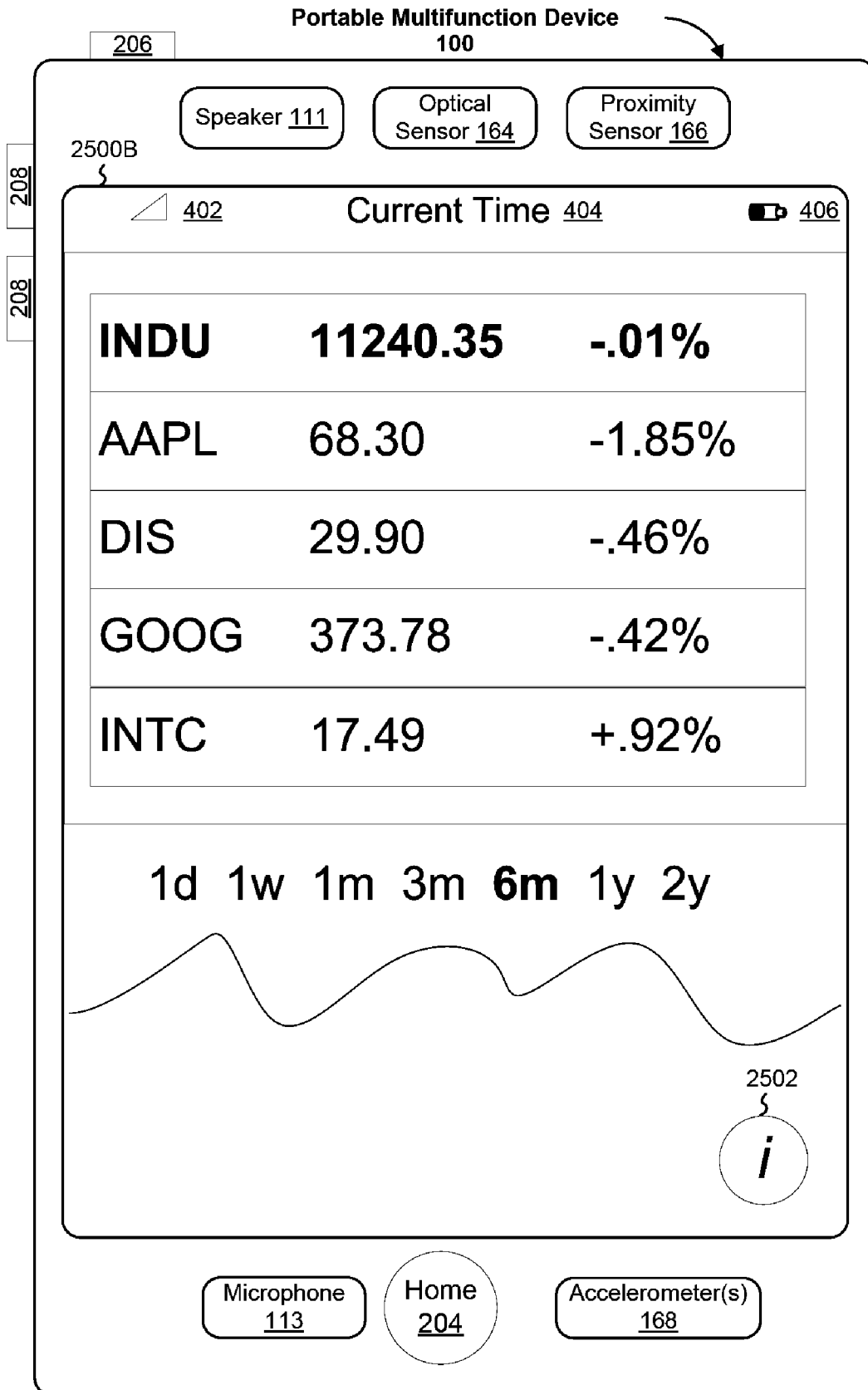

Figure 25B

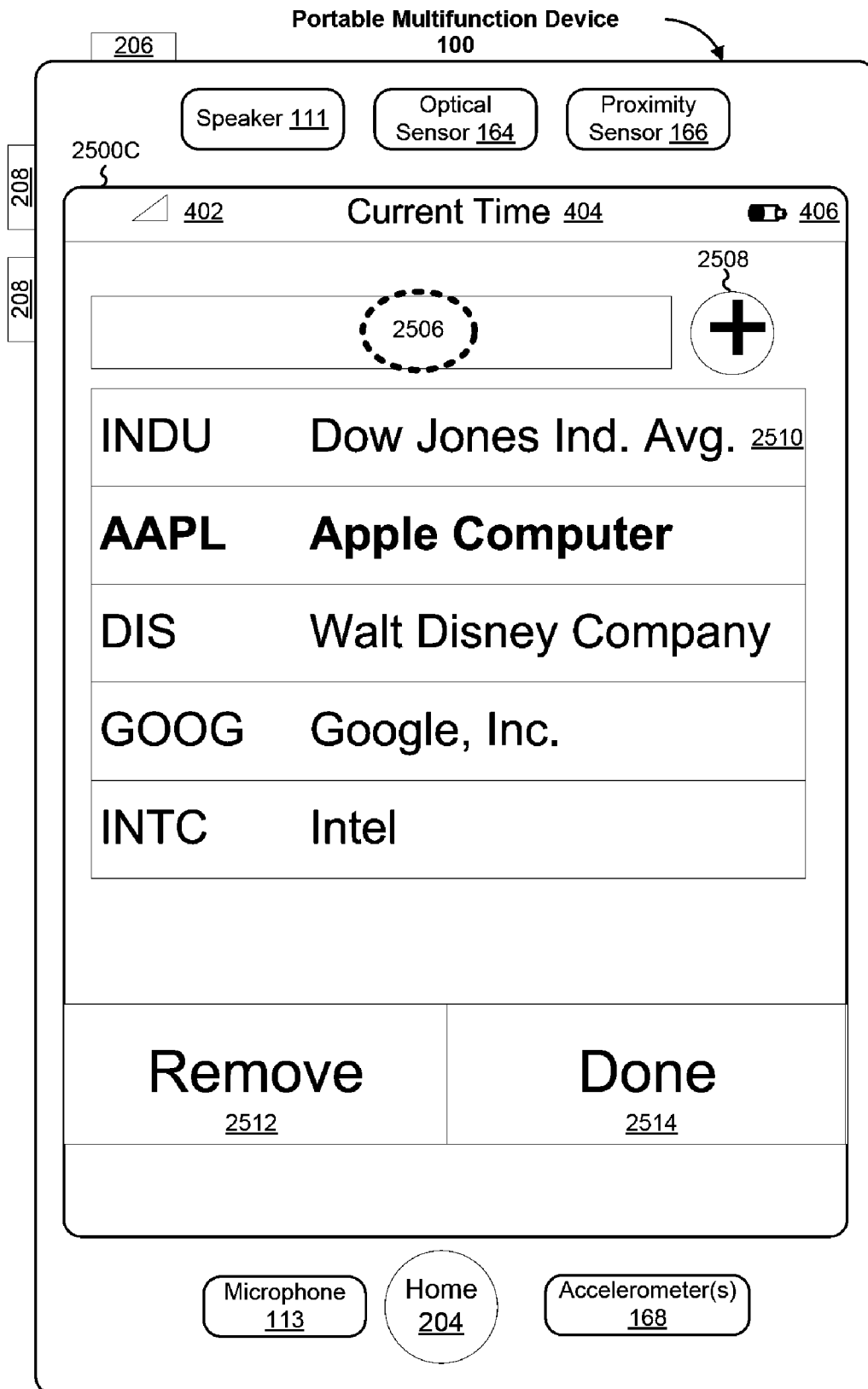

Figure 25C

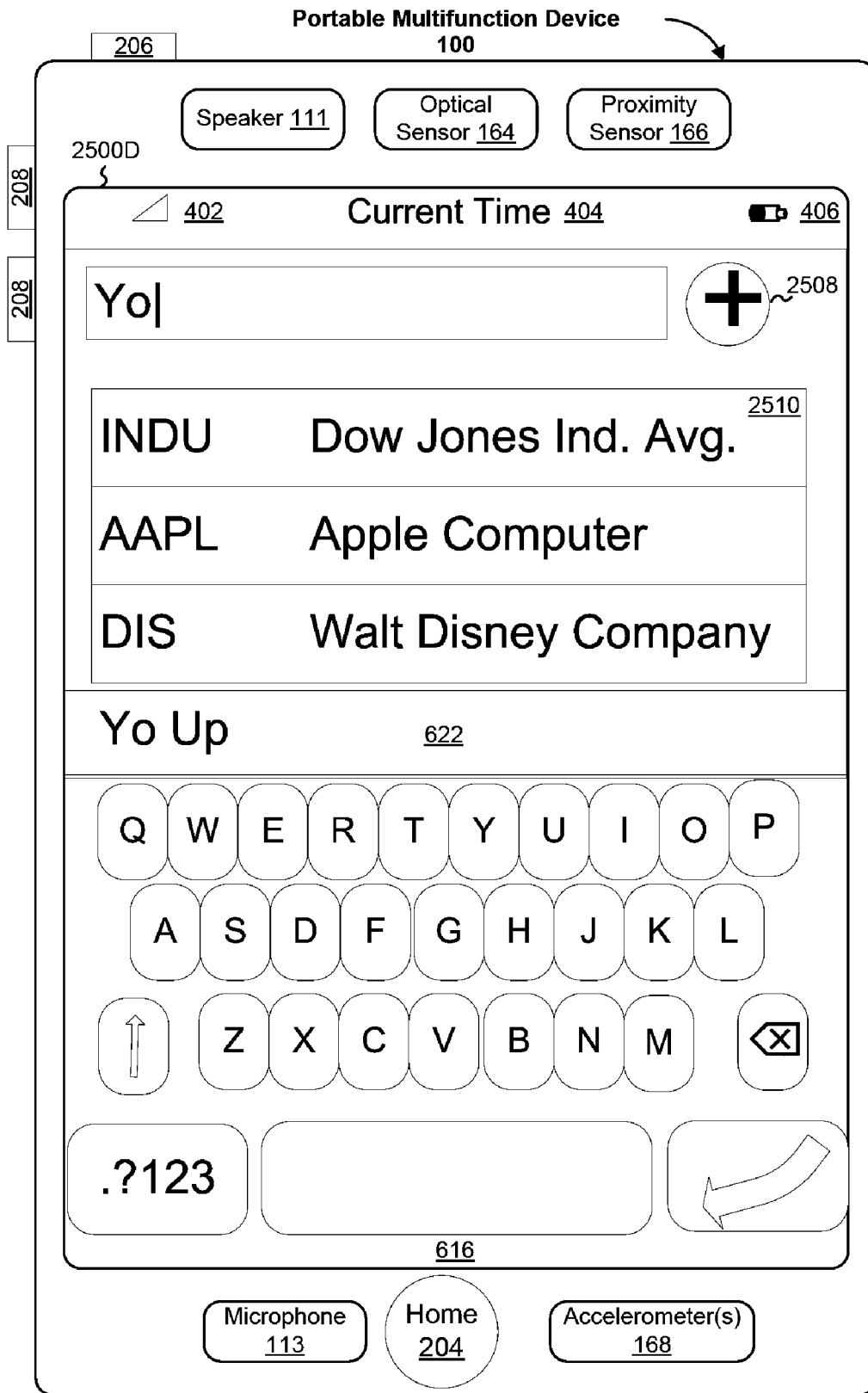

Figure 25D

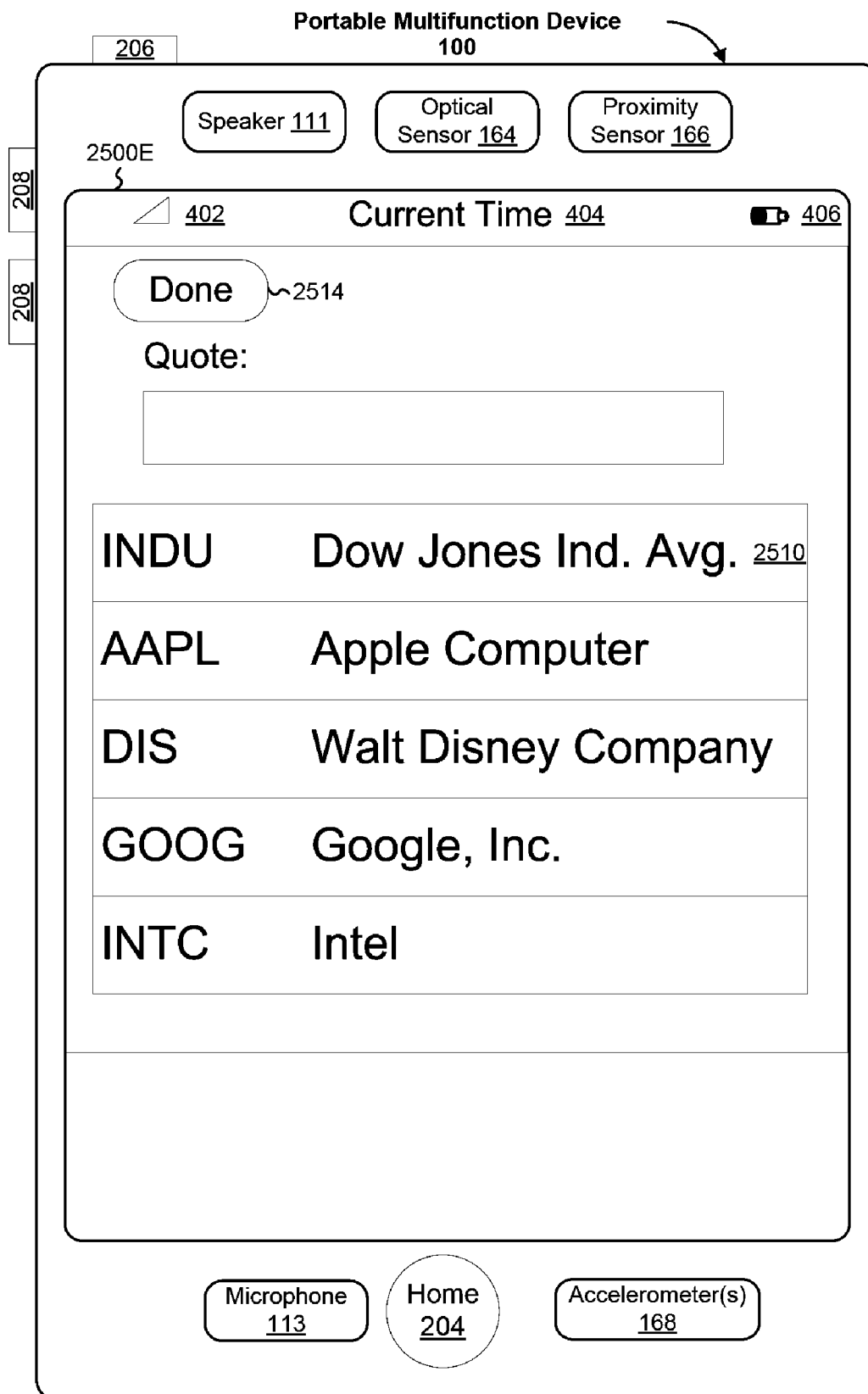

Figure 25E

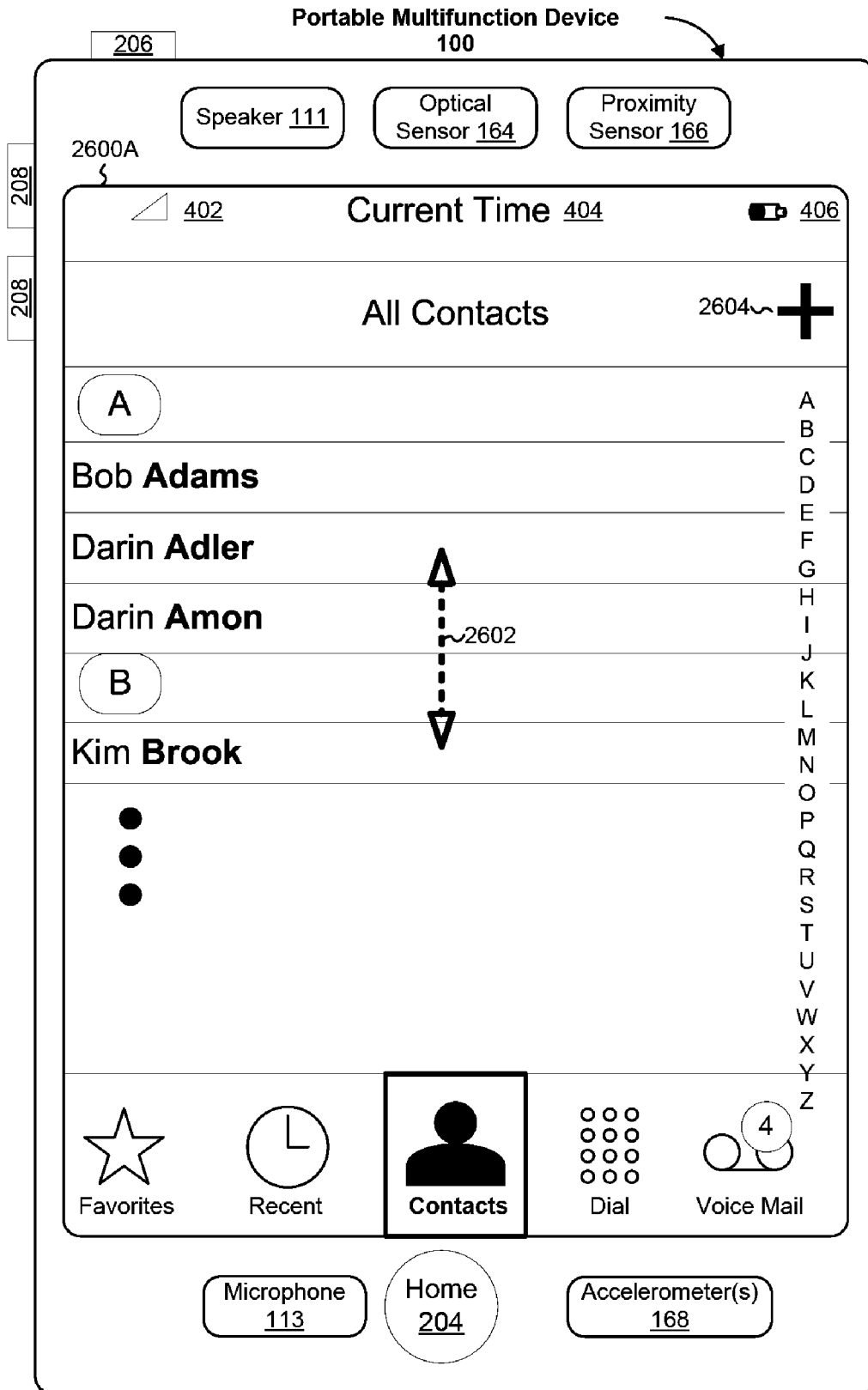

Figure 26A



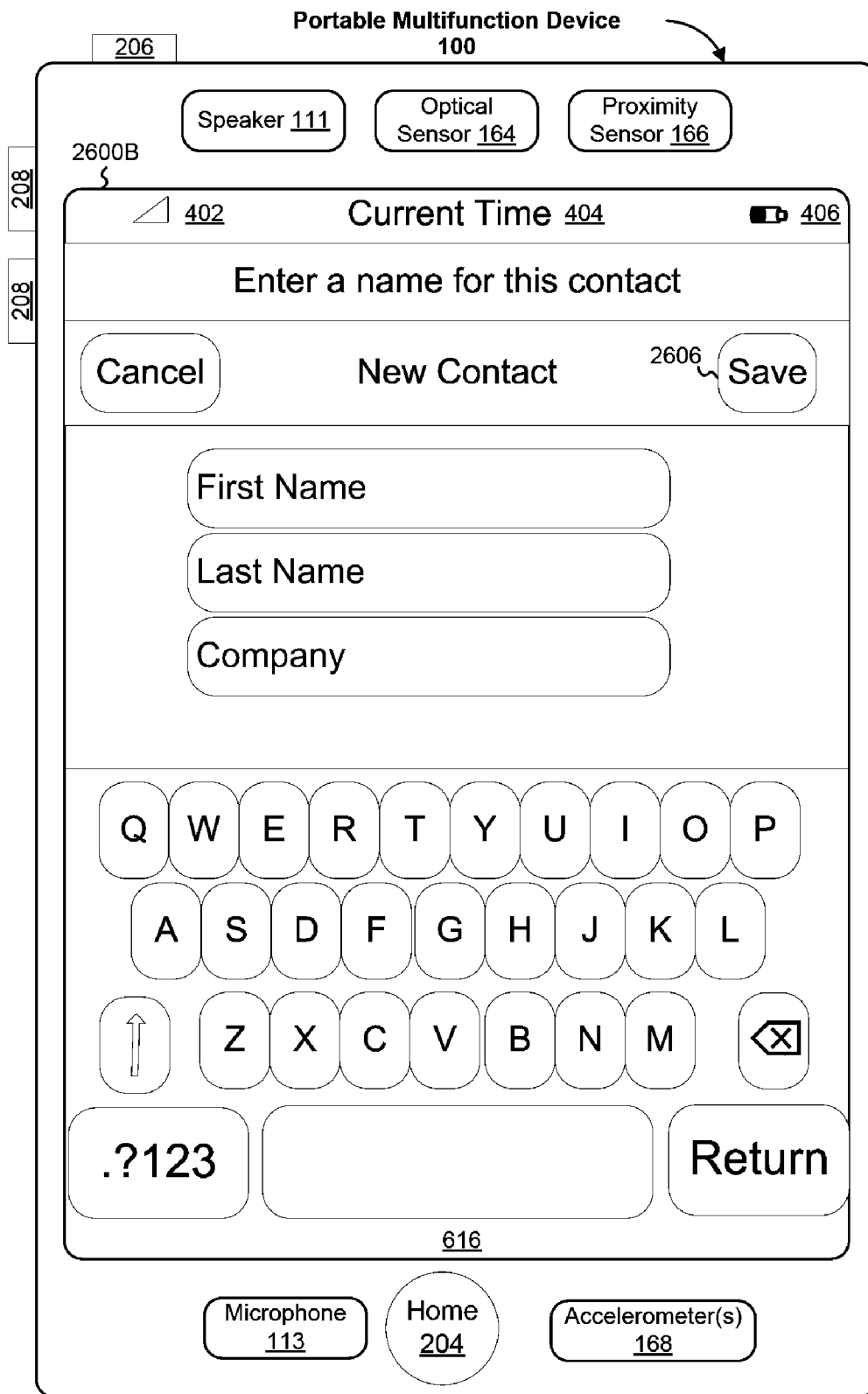

Figure 26B

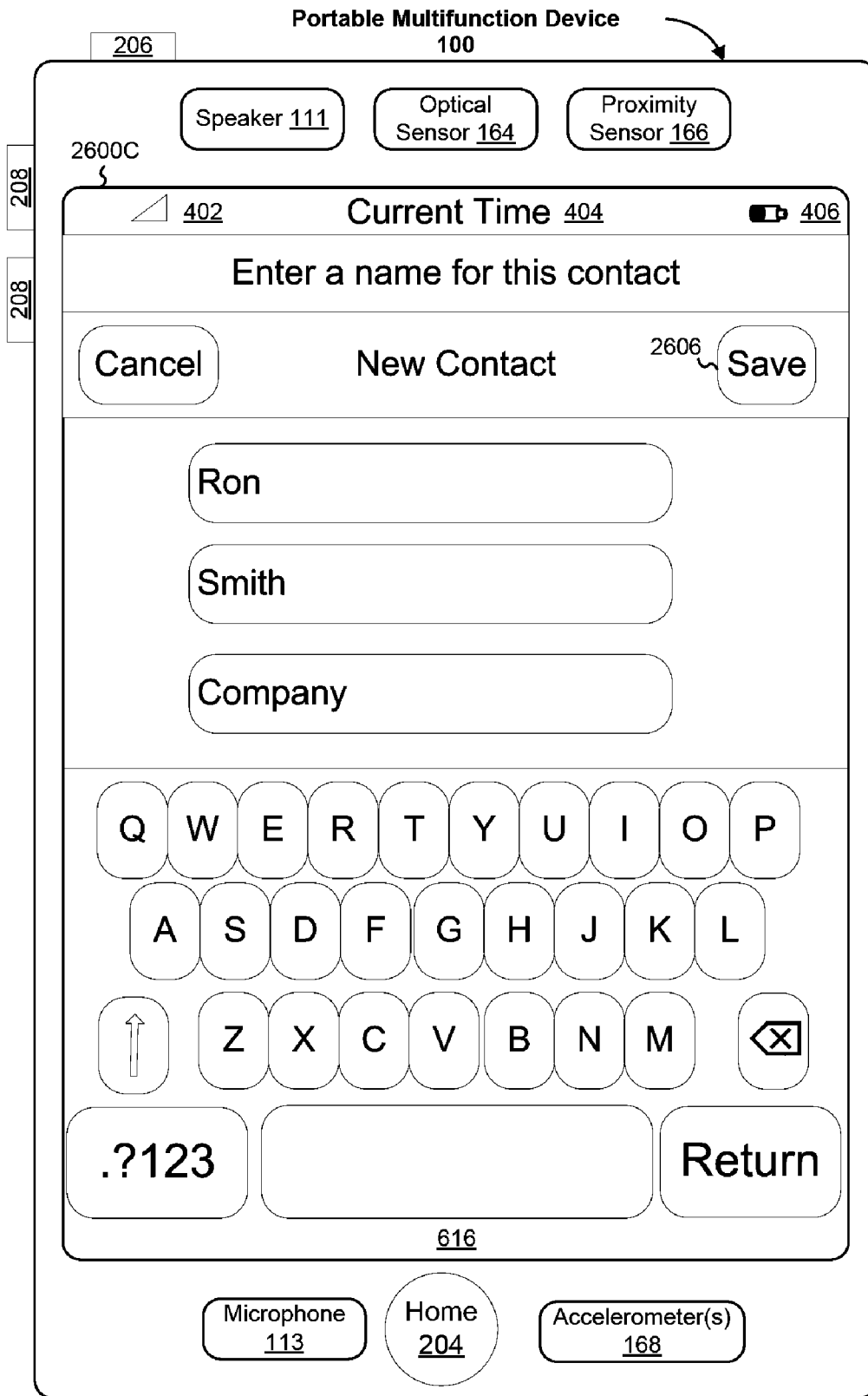

Figure 26C



Figure 26D

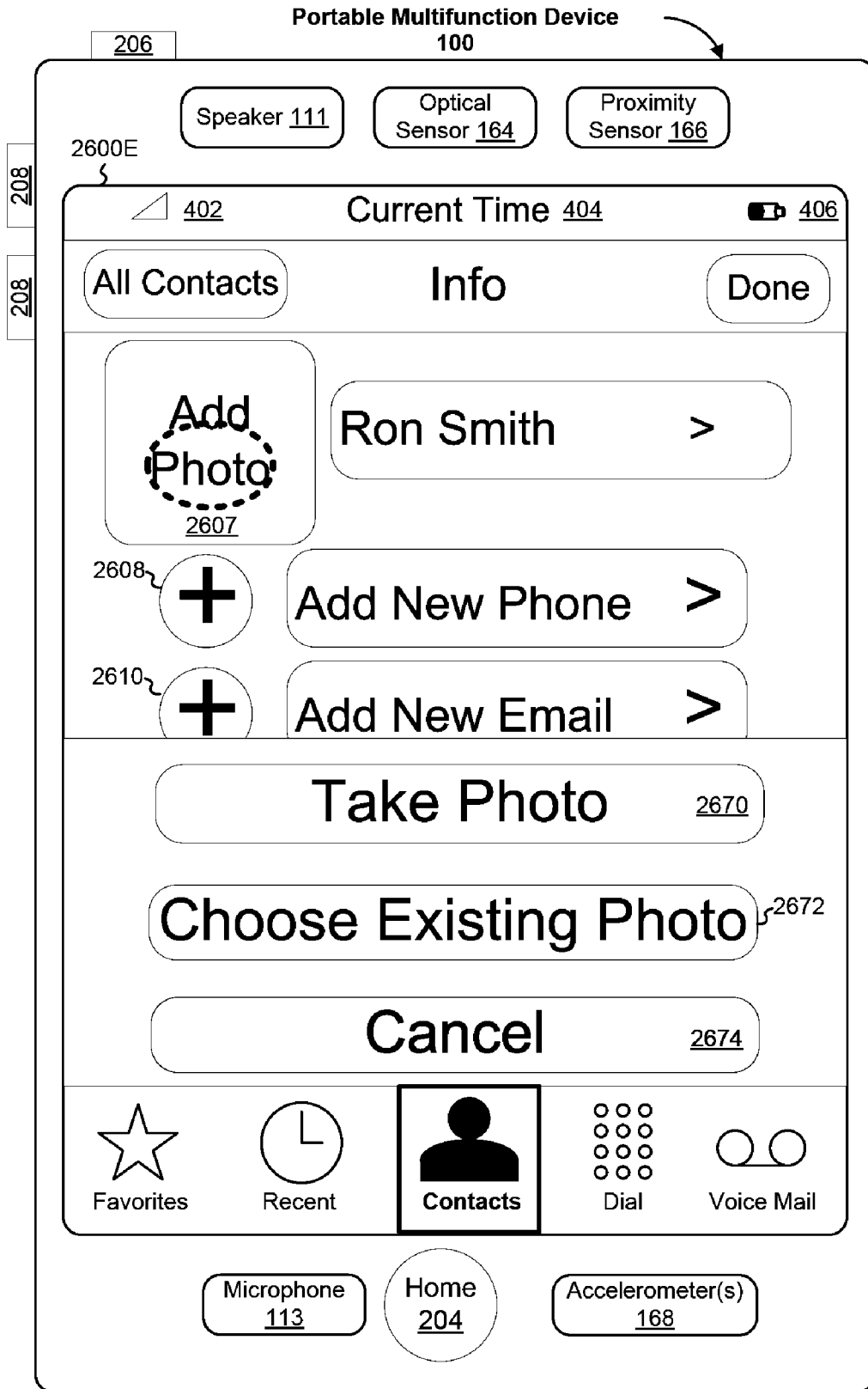

Figure 26E

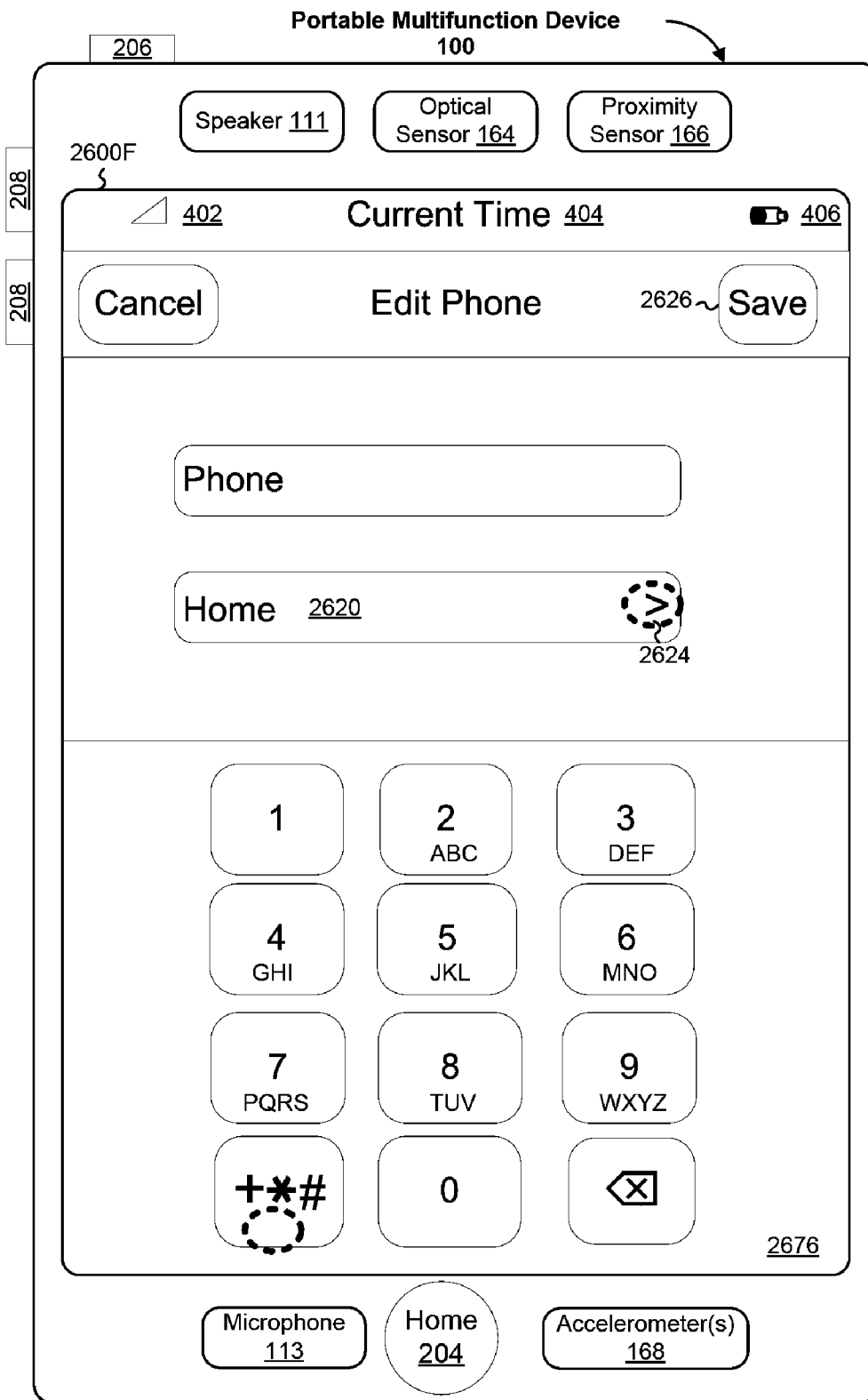

Figure 26F

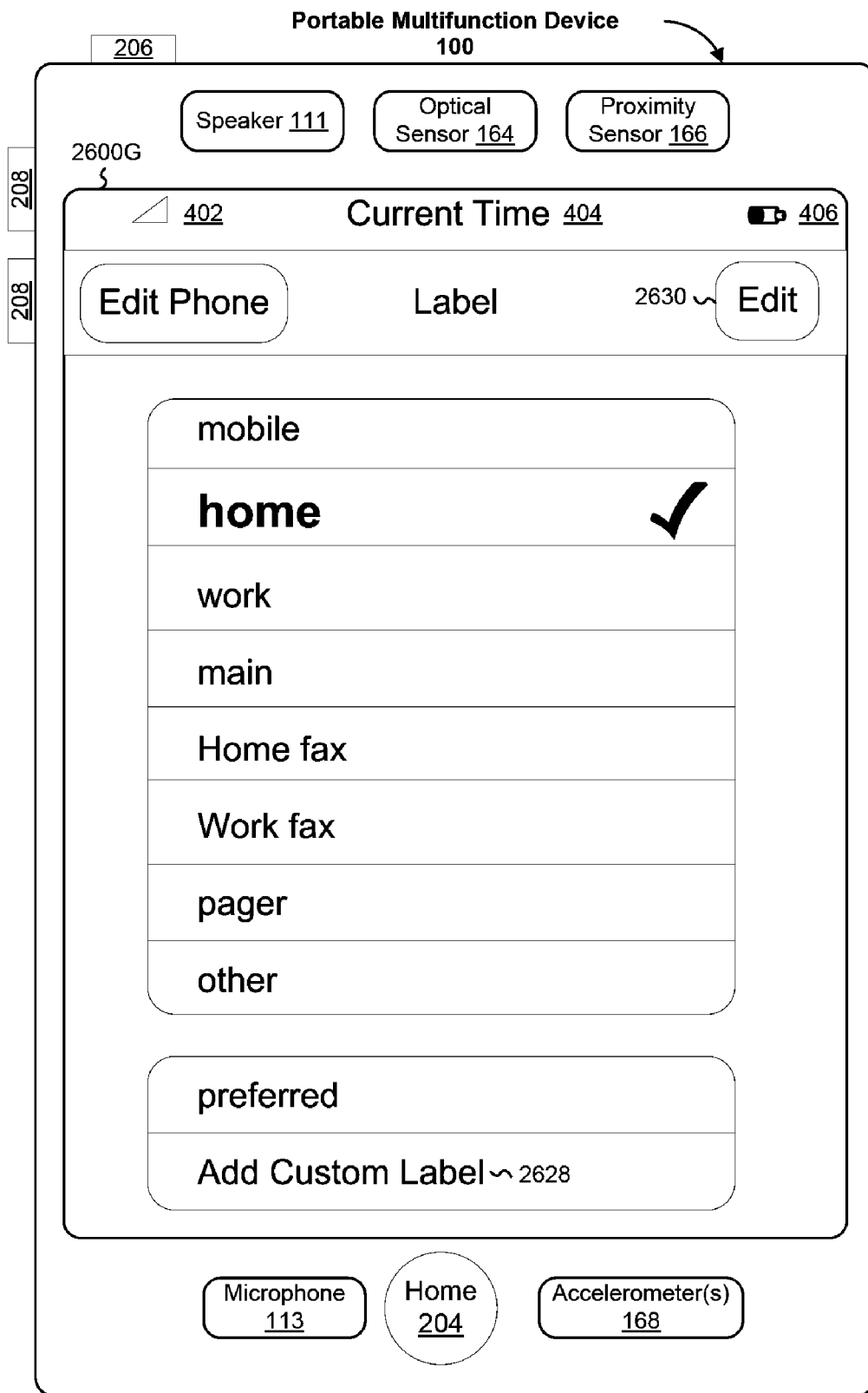

Figure 26G

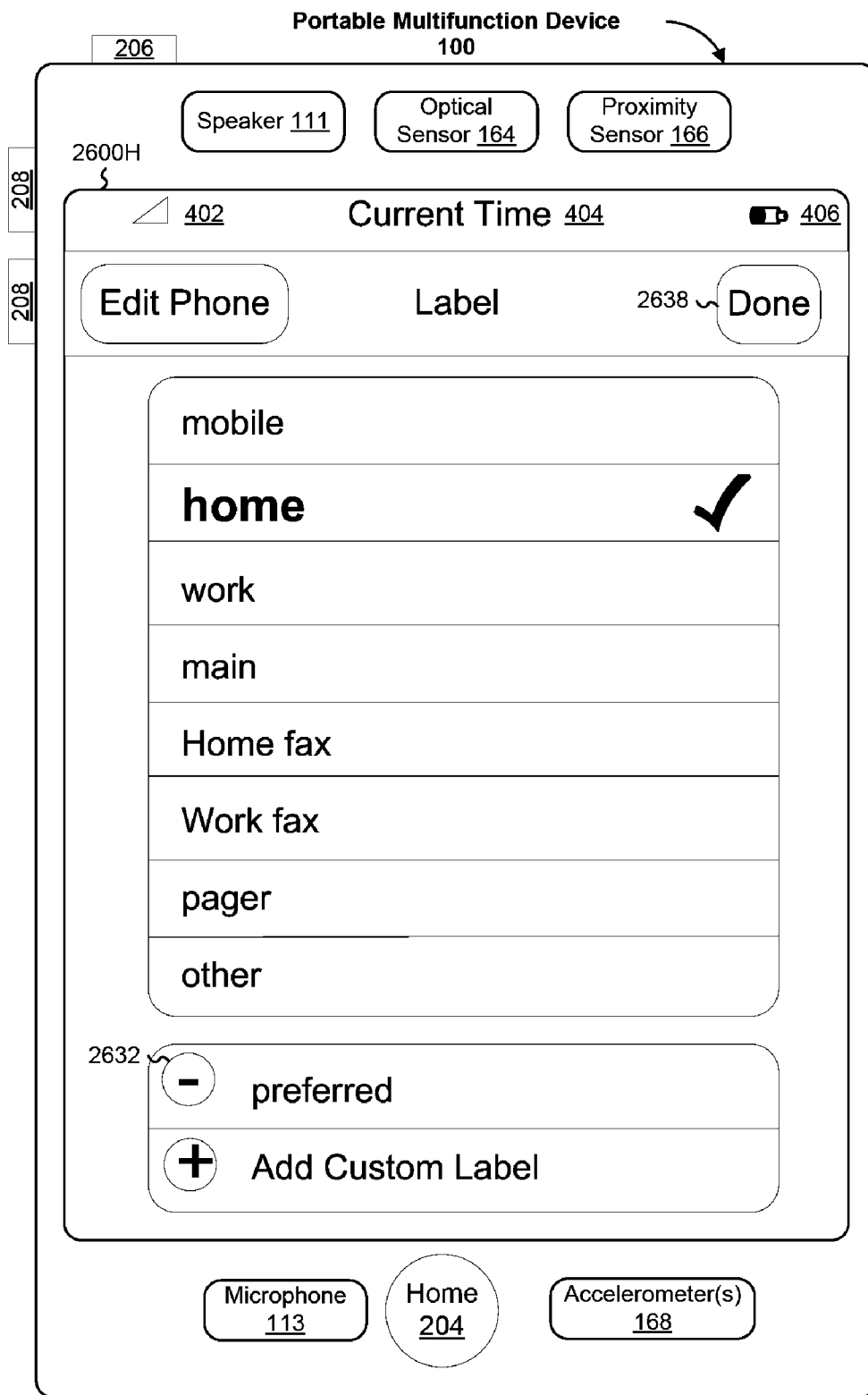

Figure 26H

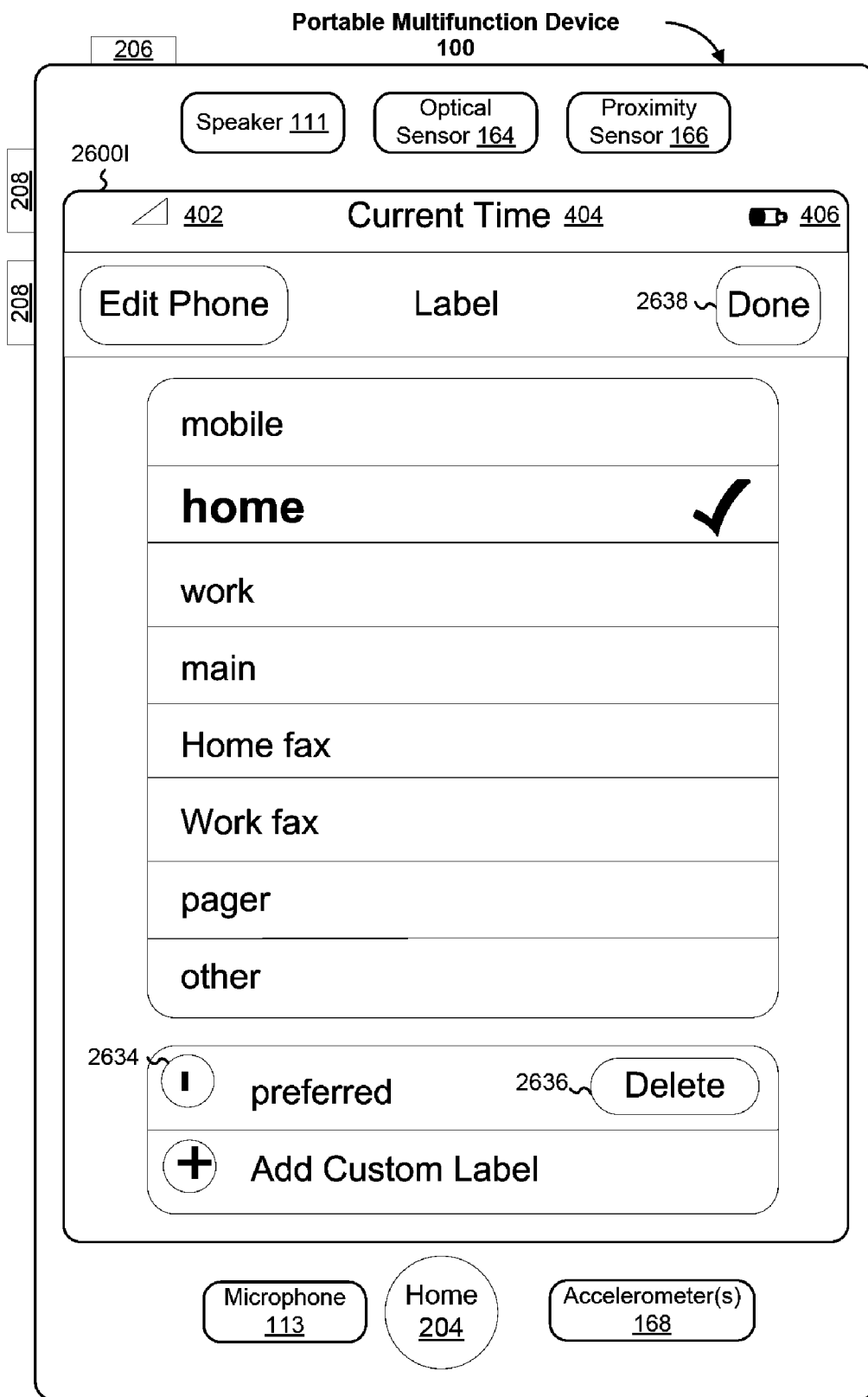

Figure 26I



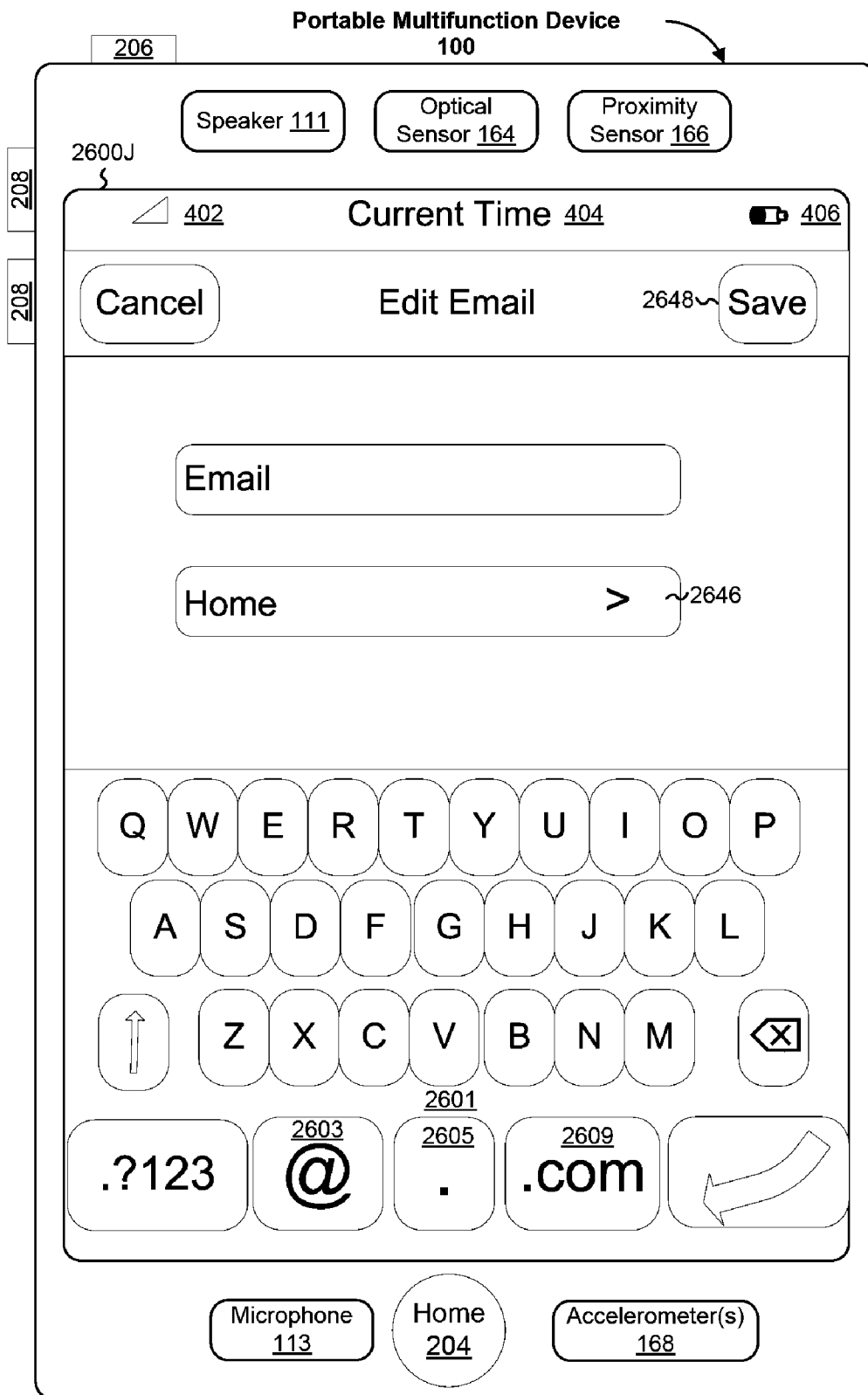

Figure 26J

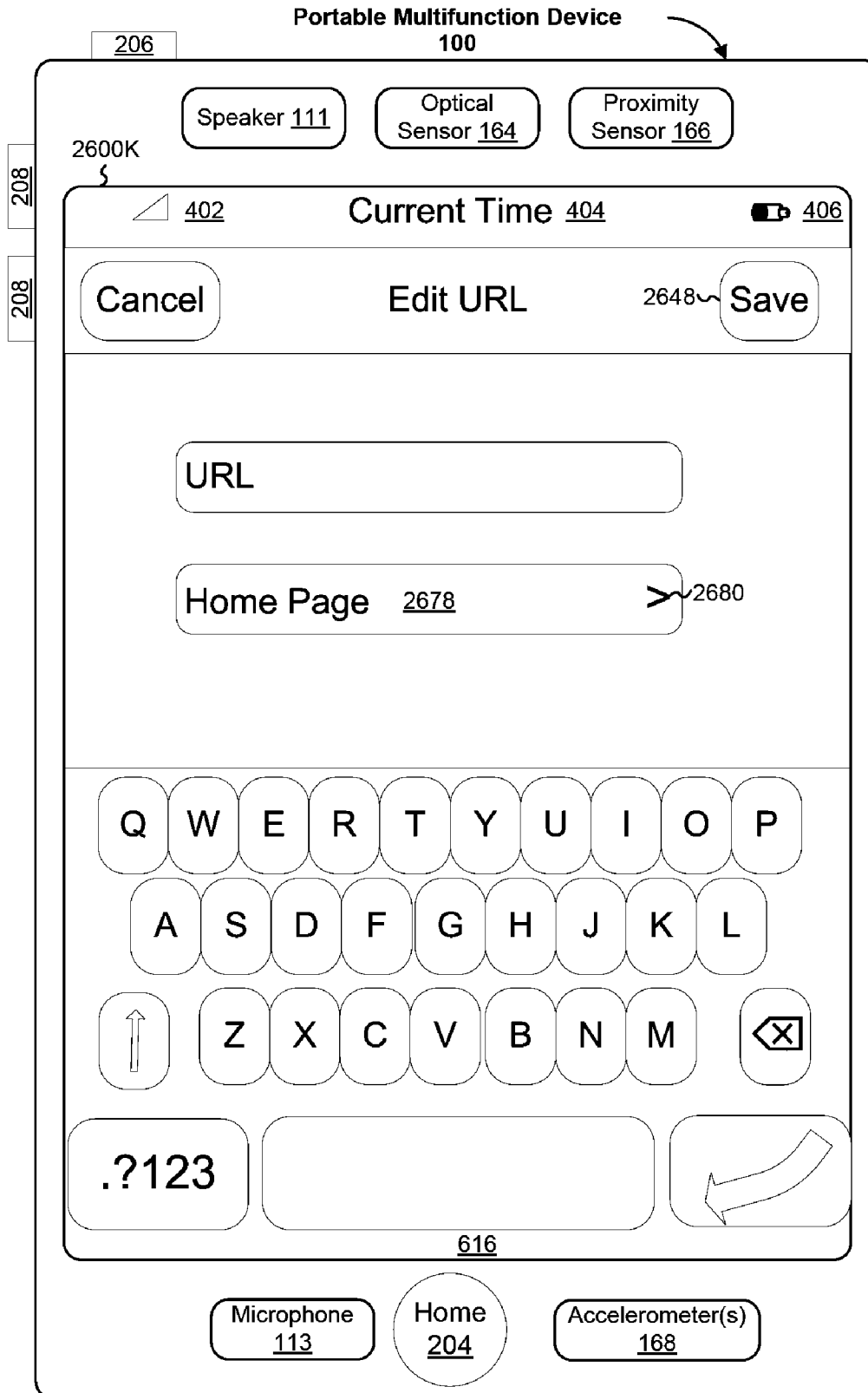

Figure 26K



Figure 26L

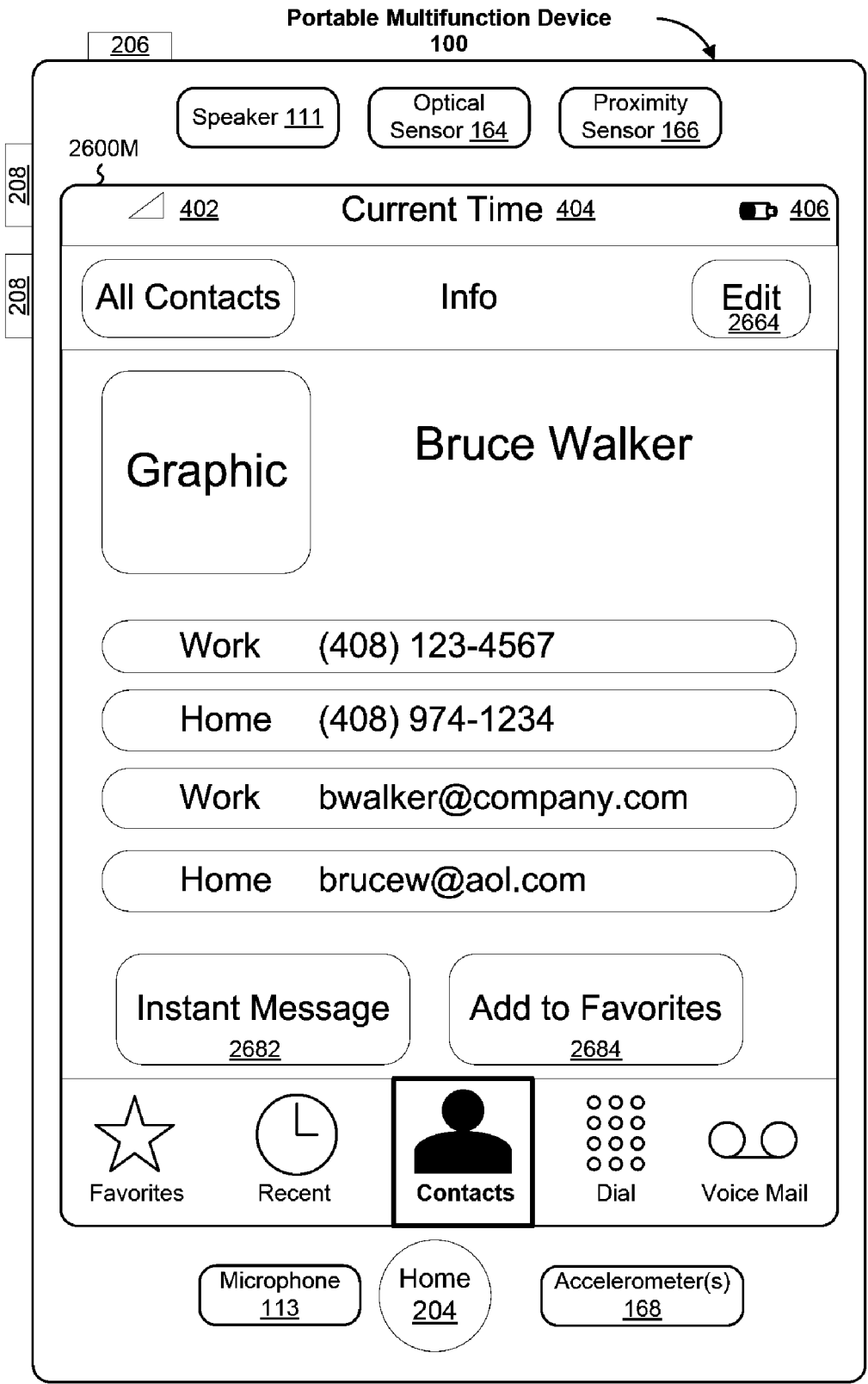

Figure 26M

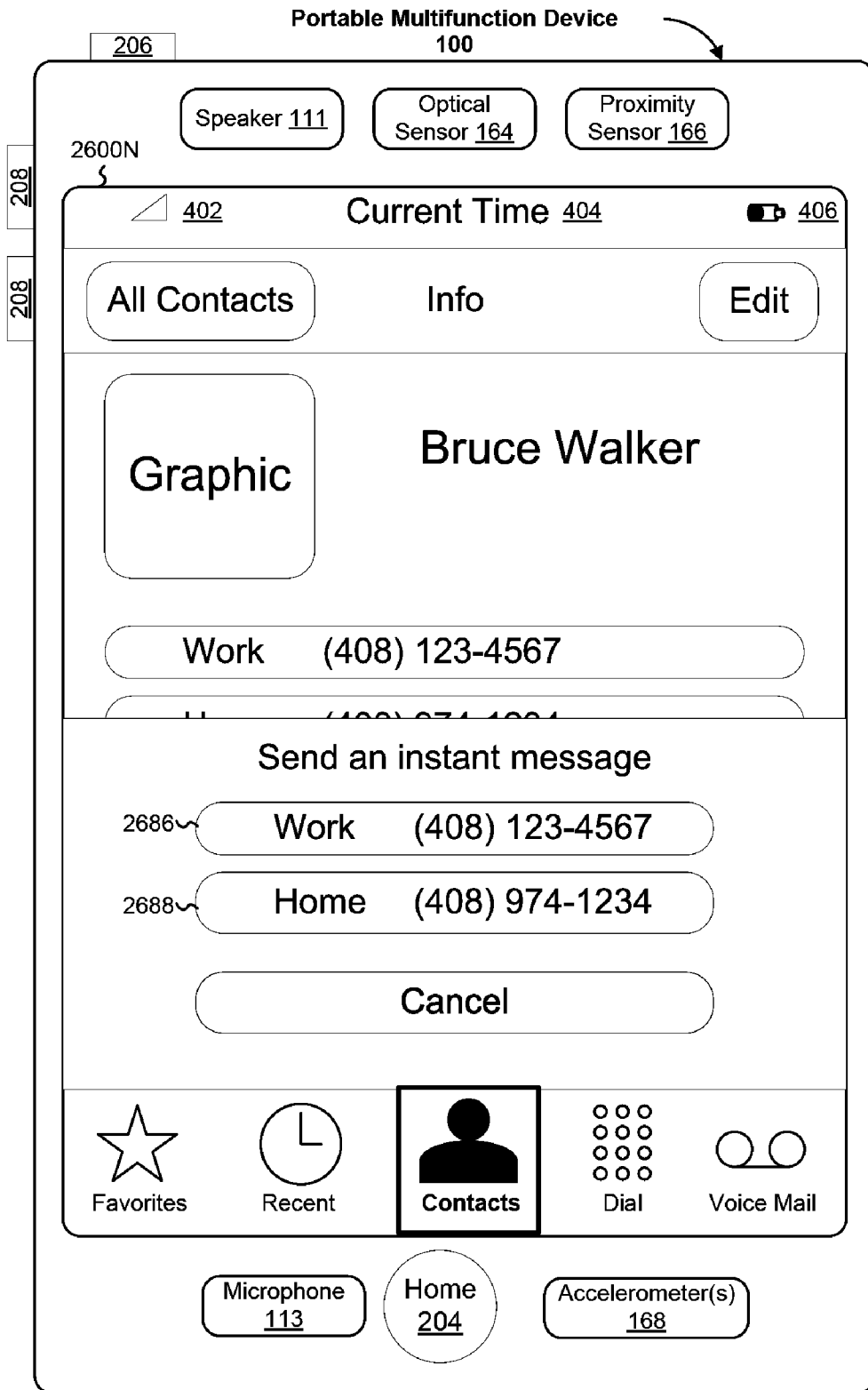

Figure 26N

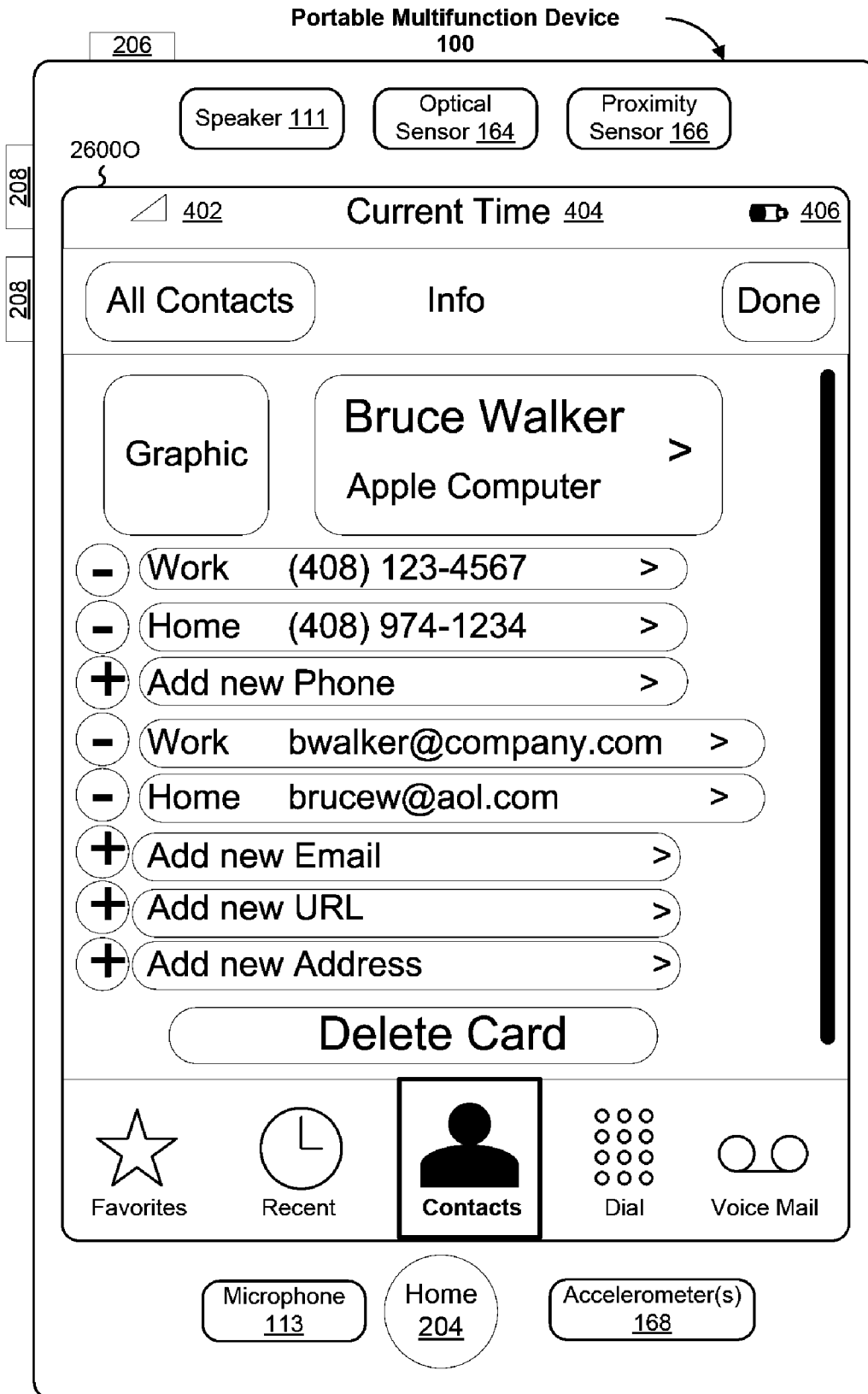

Figure 260

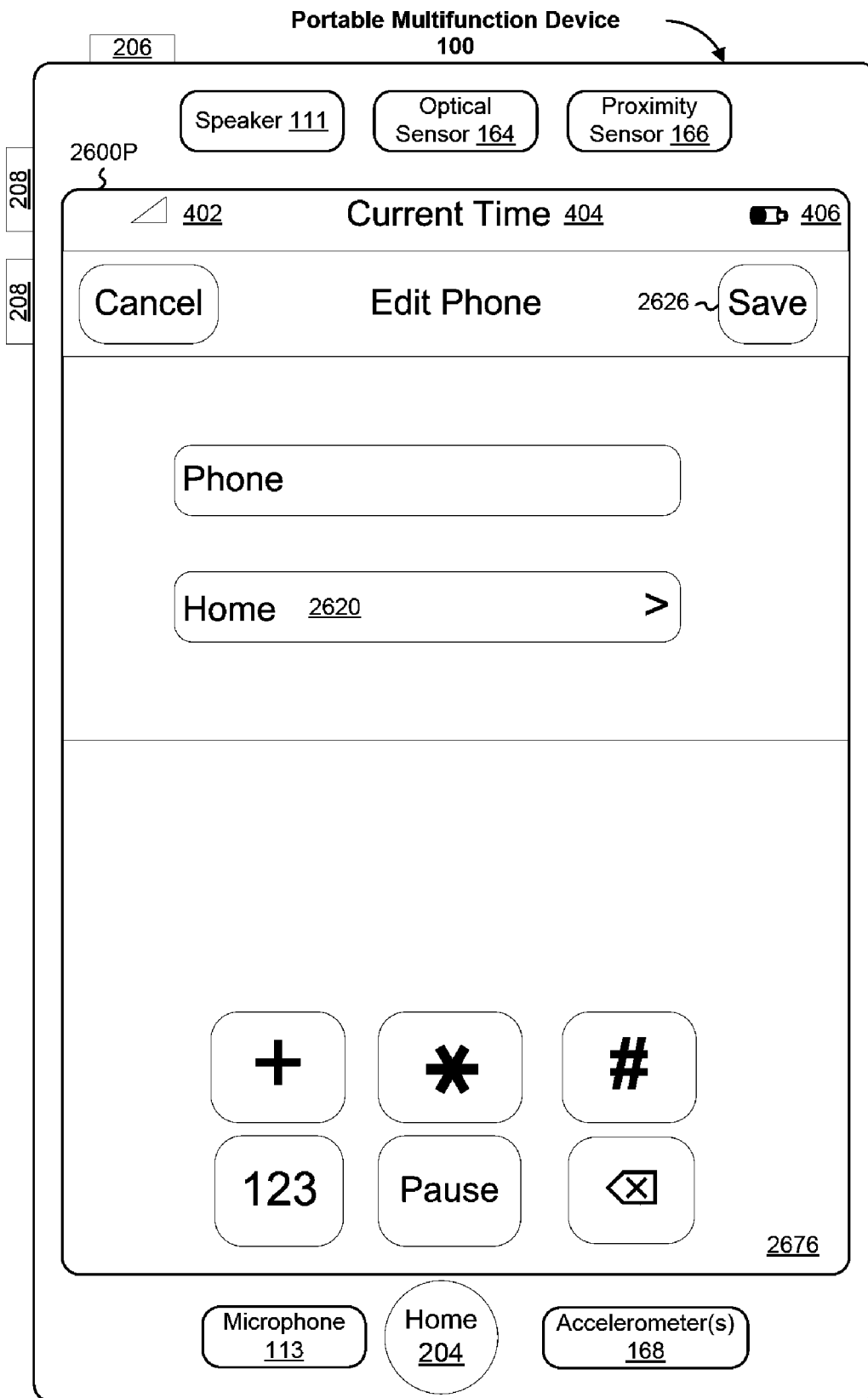

Figure 26P

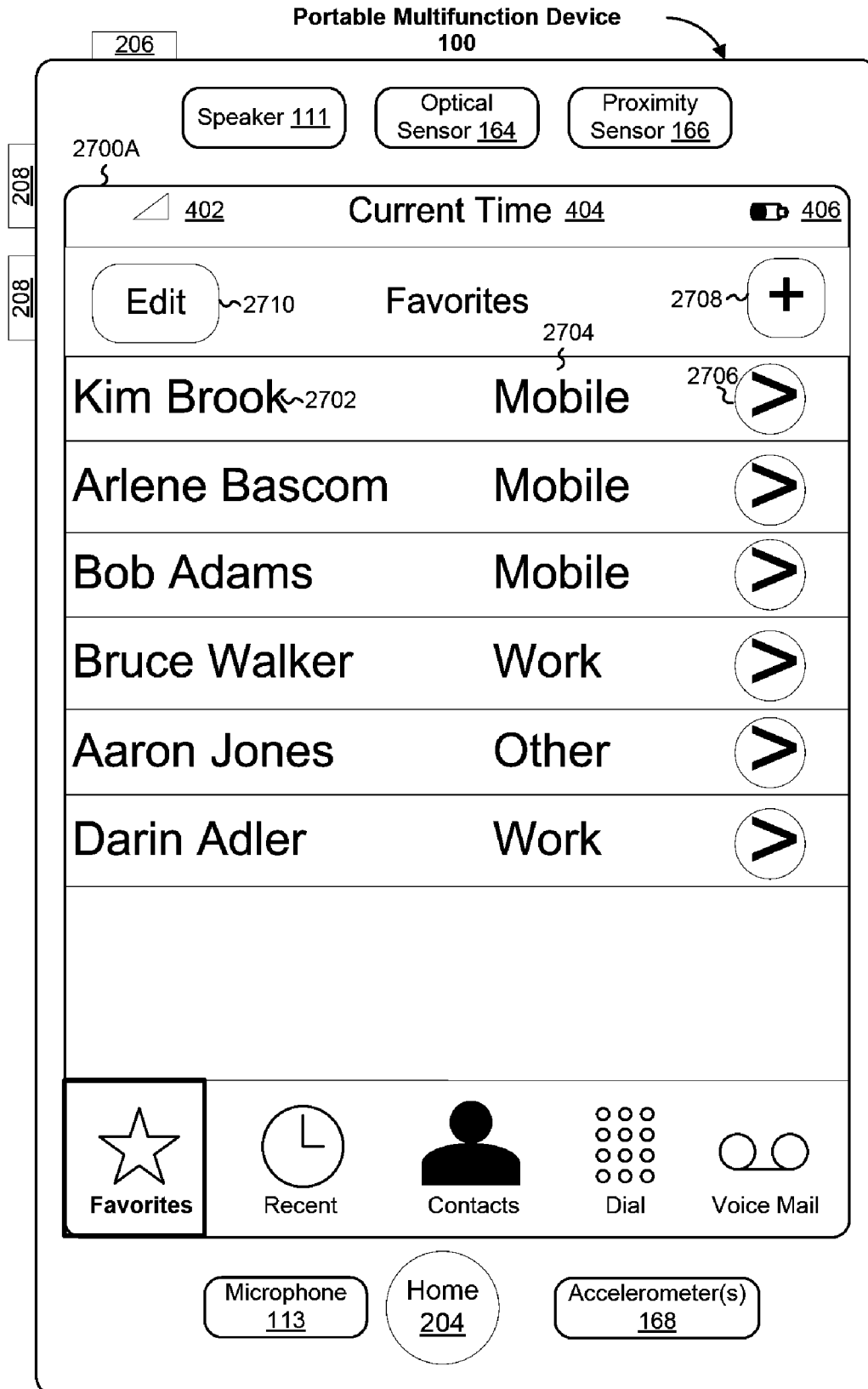

Figure 27A



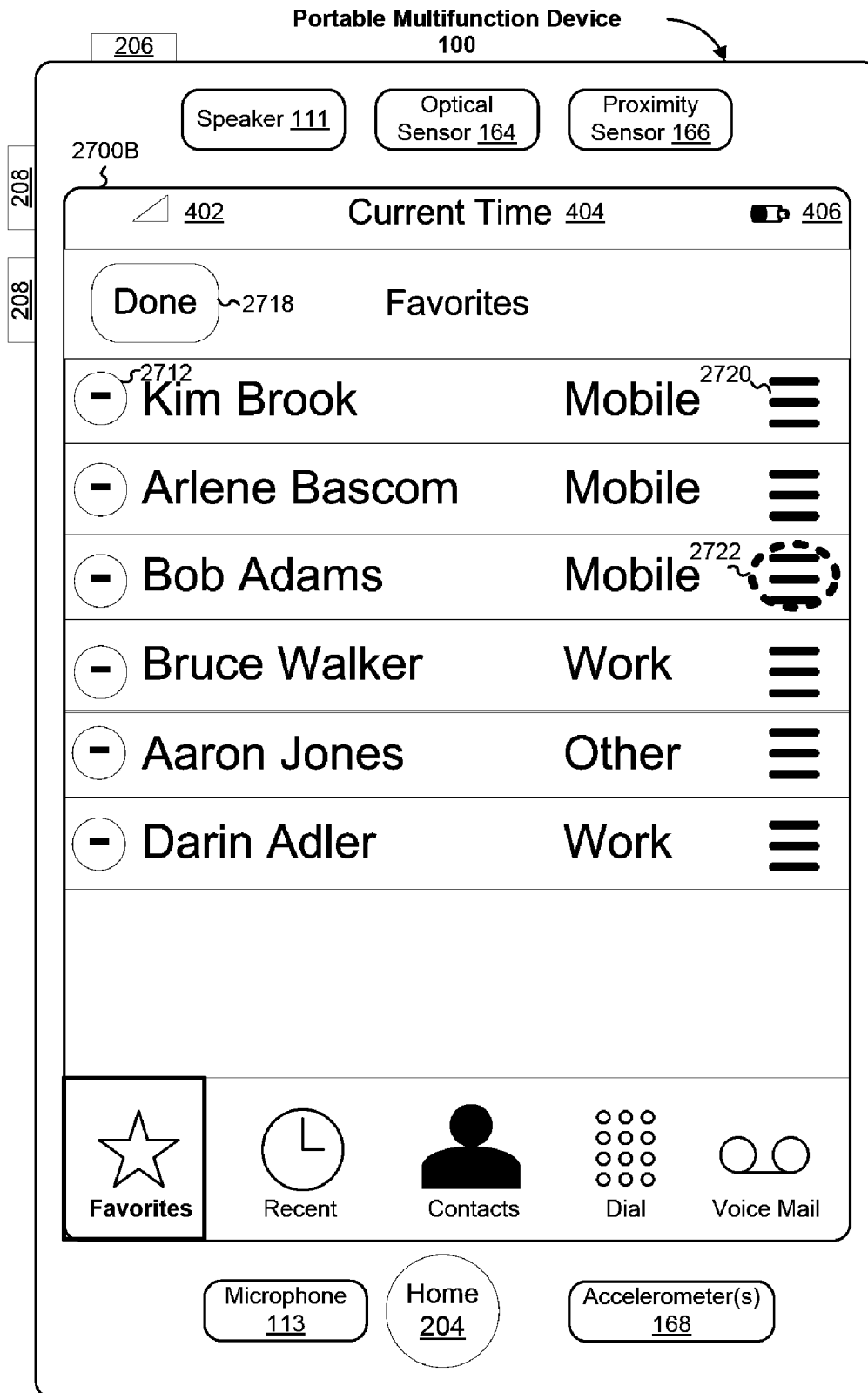

Figure 27B

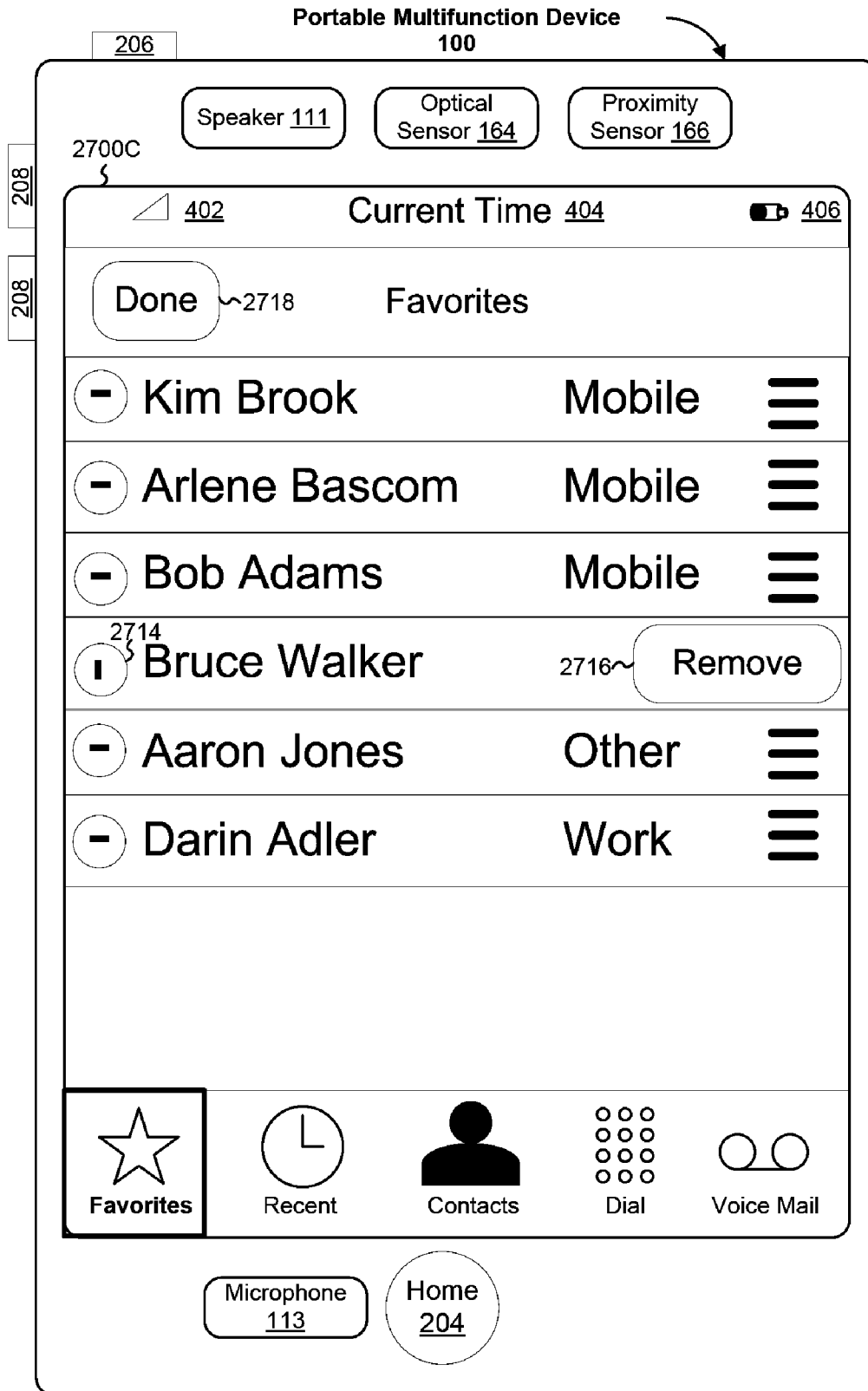

Figure 27C

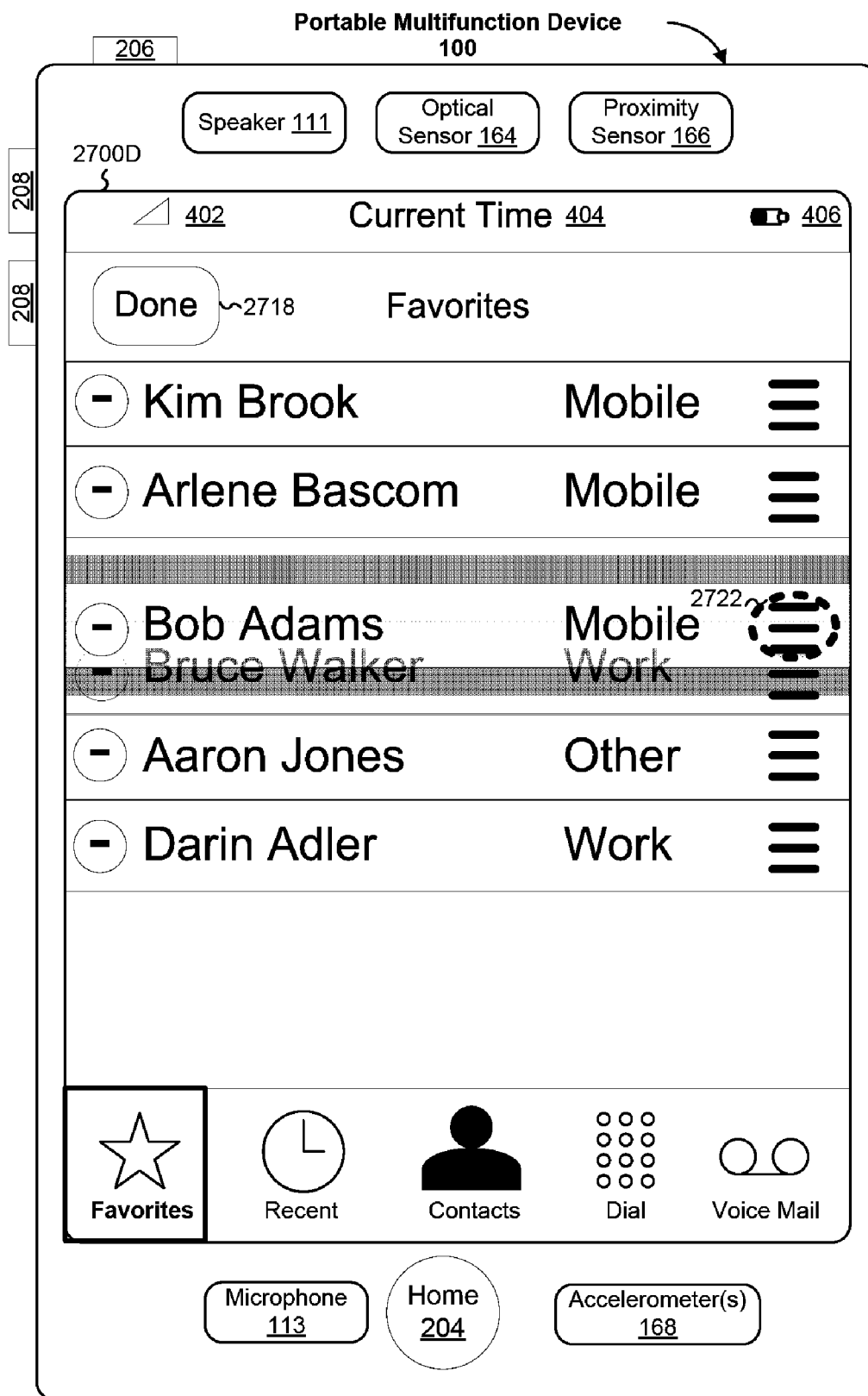

Figure 27D

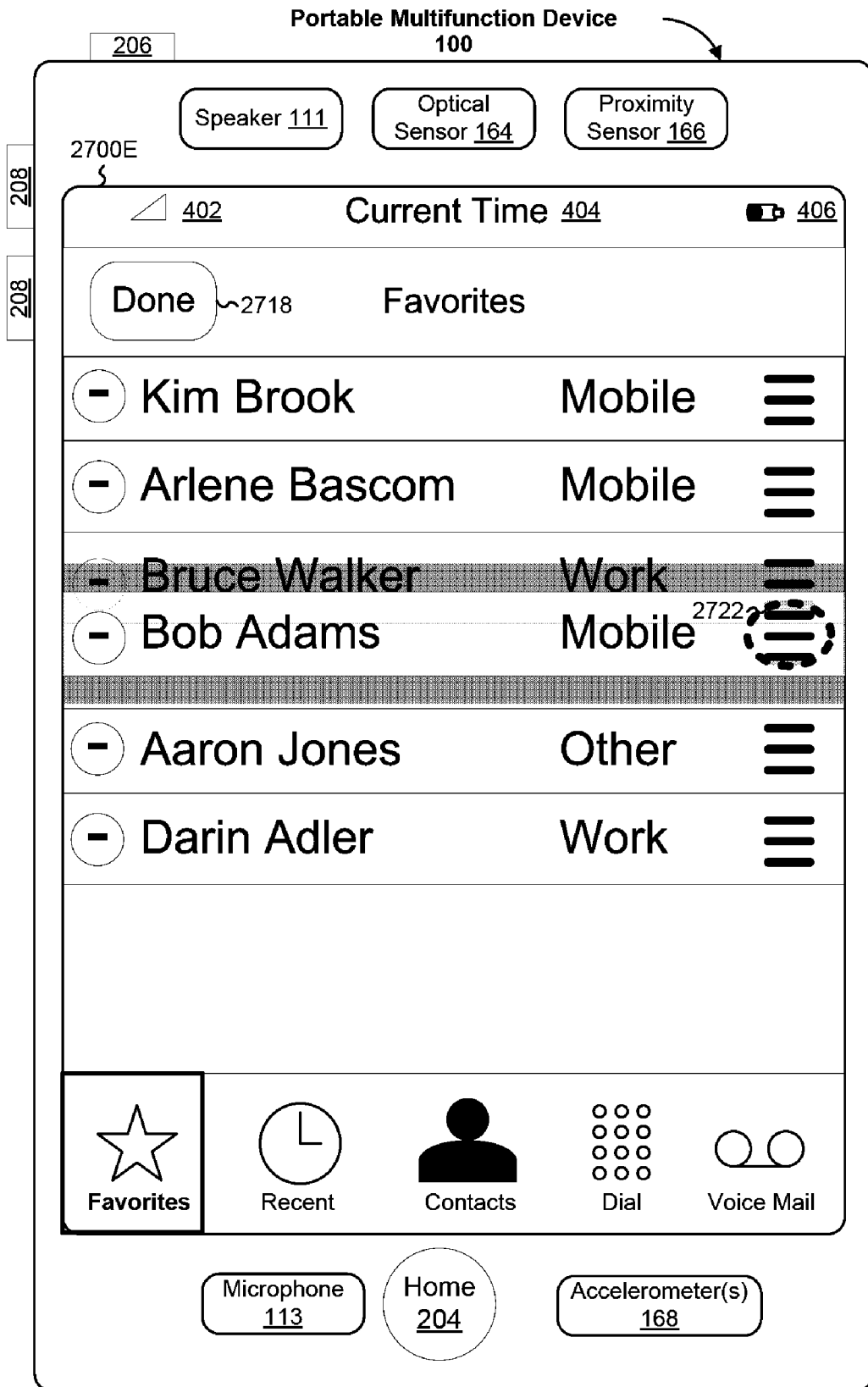

Figure 27E

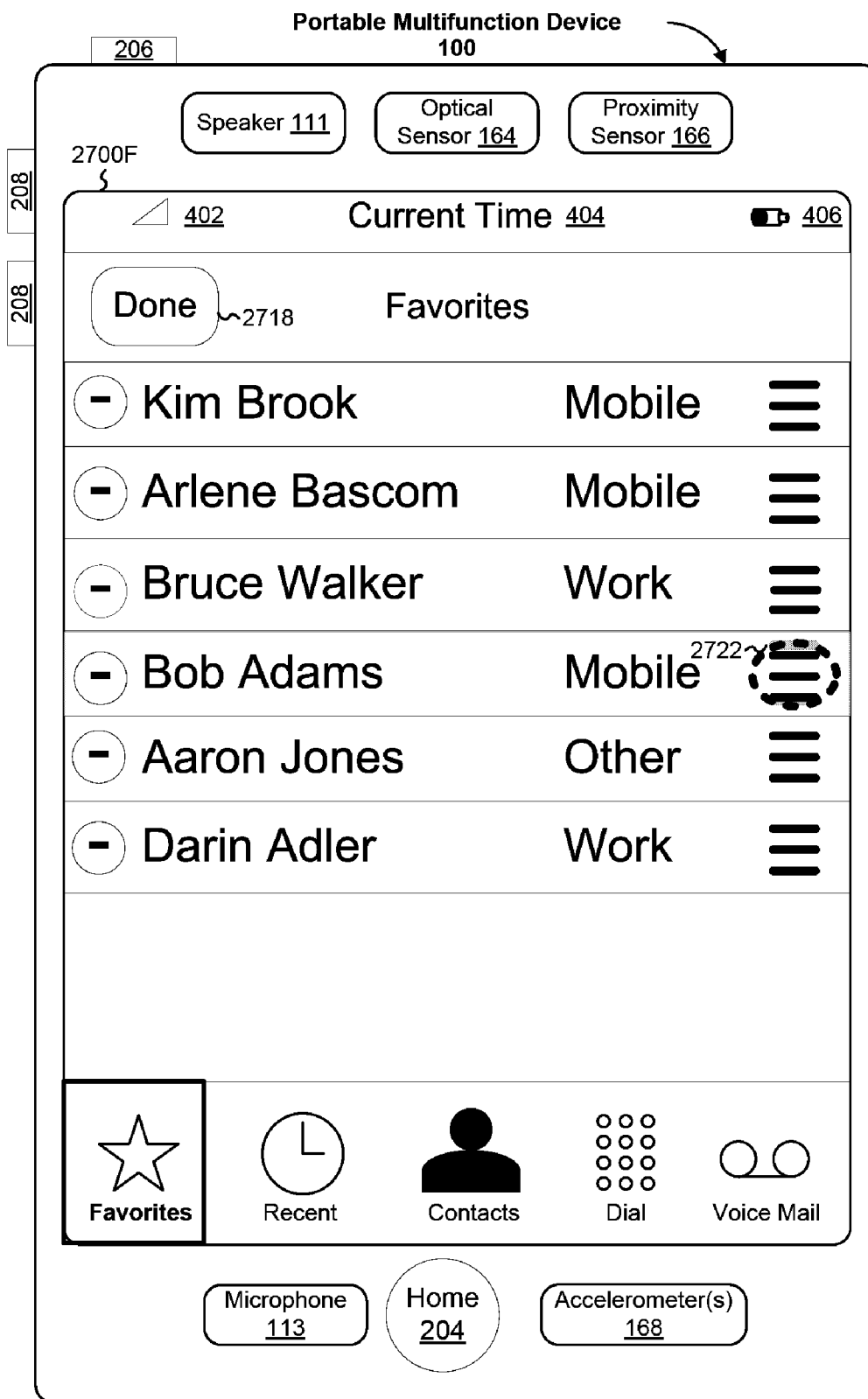

Figure 27F

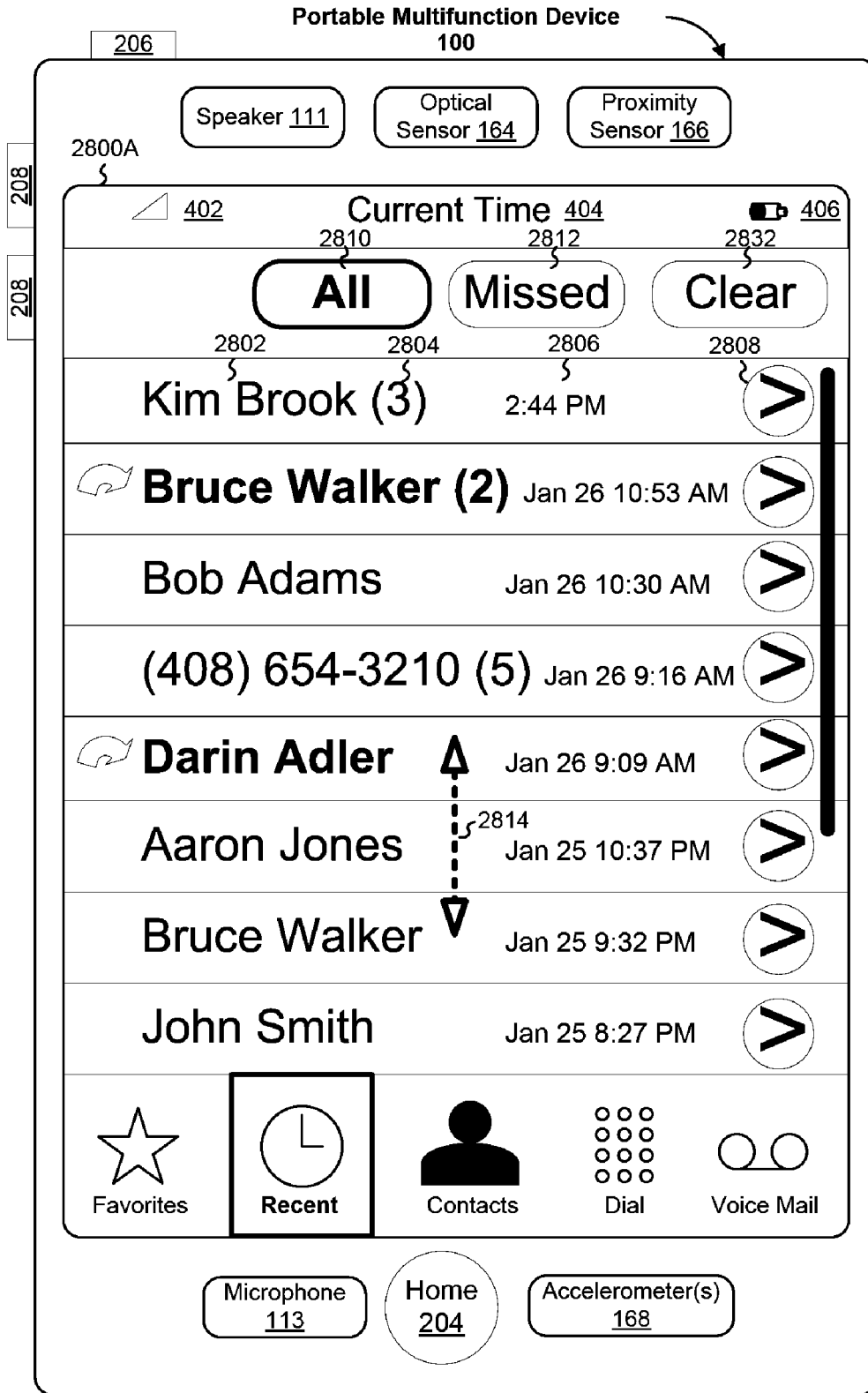

Figure 28A

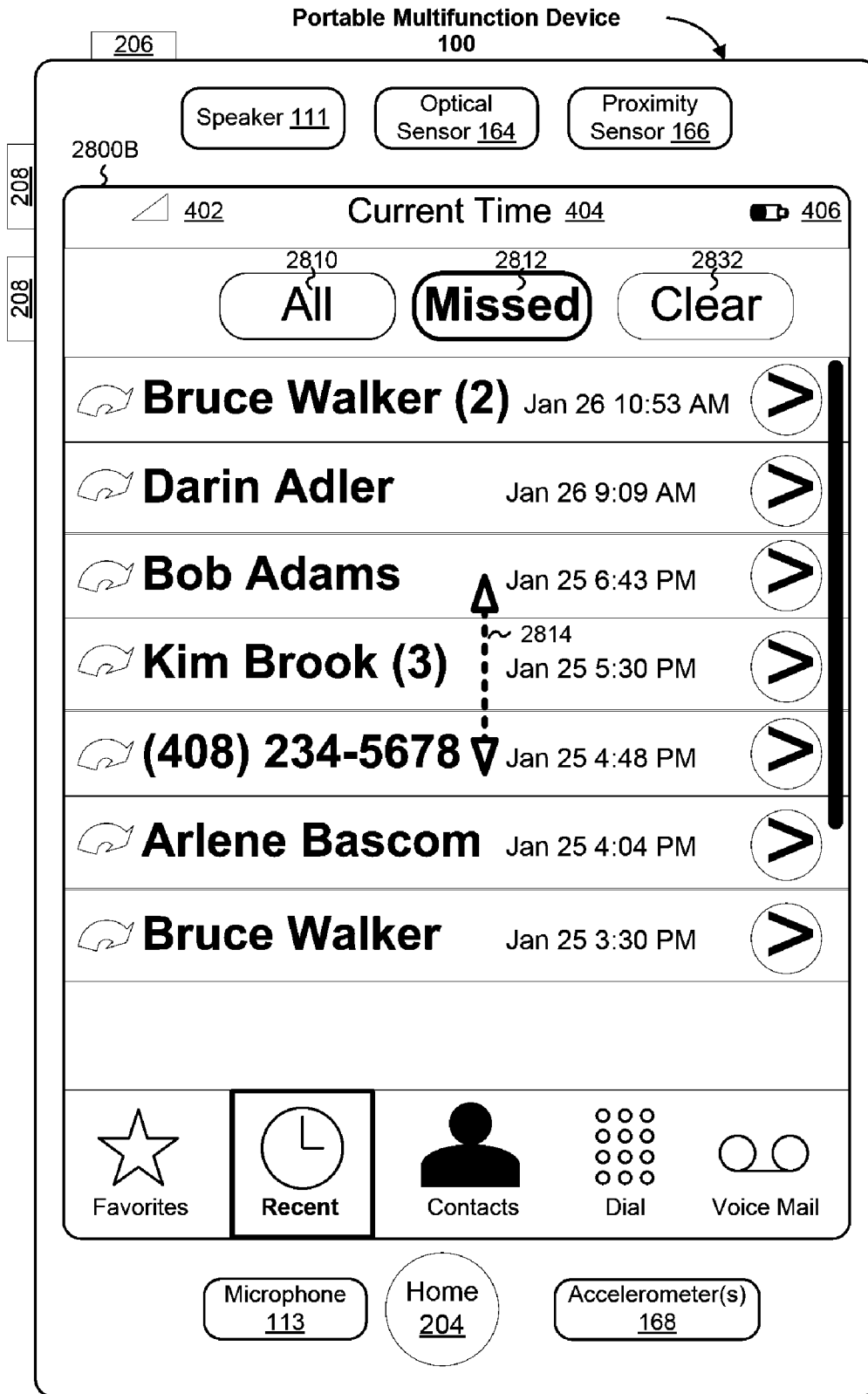

Figure 28B

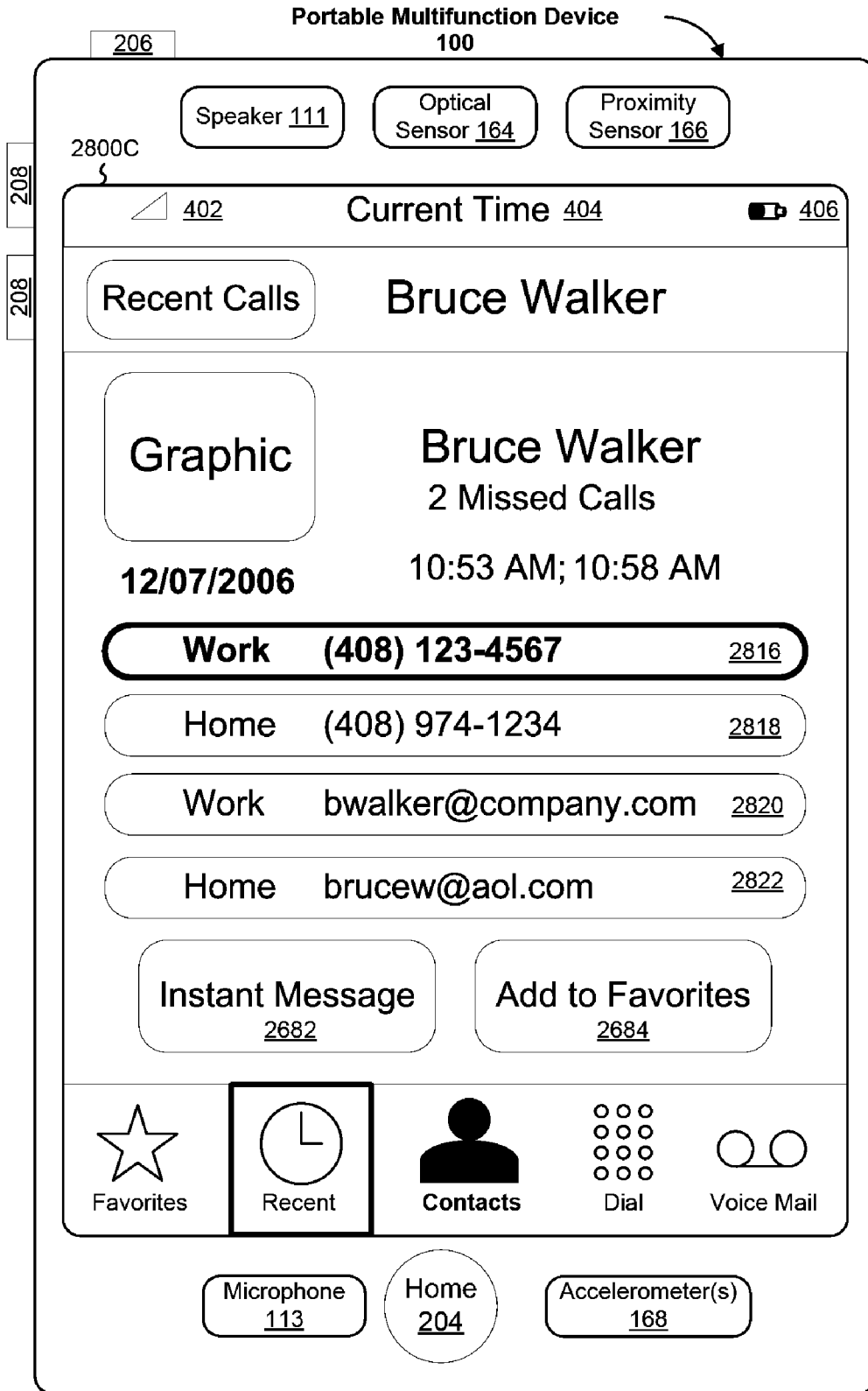

Figure 28C



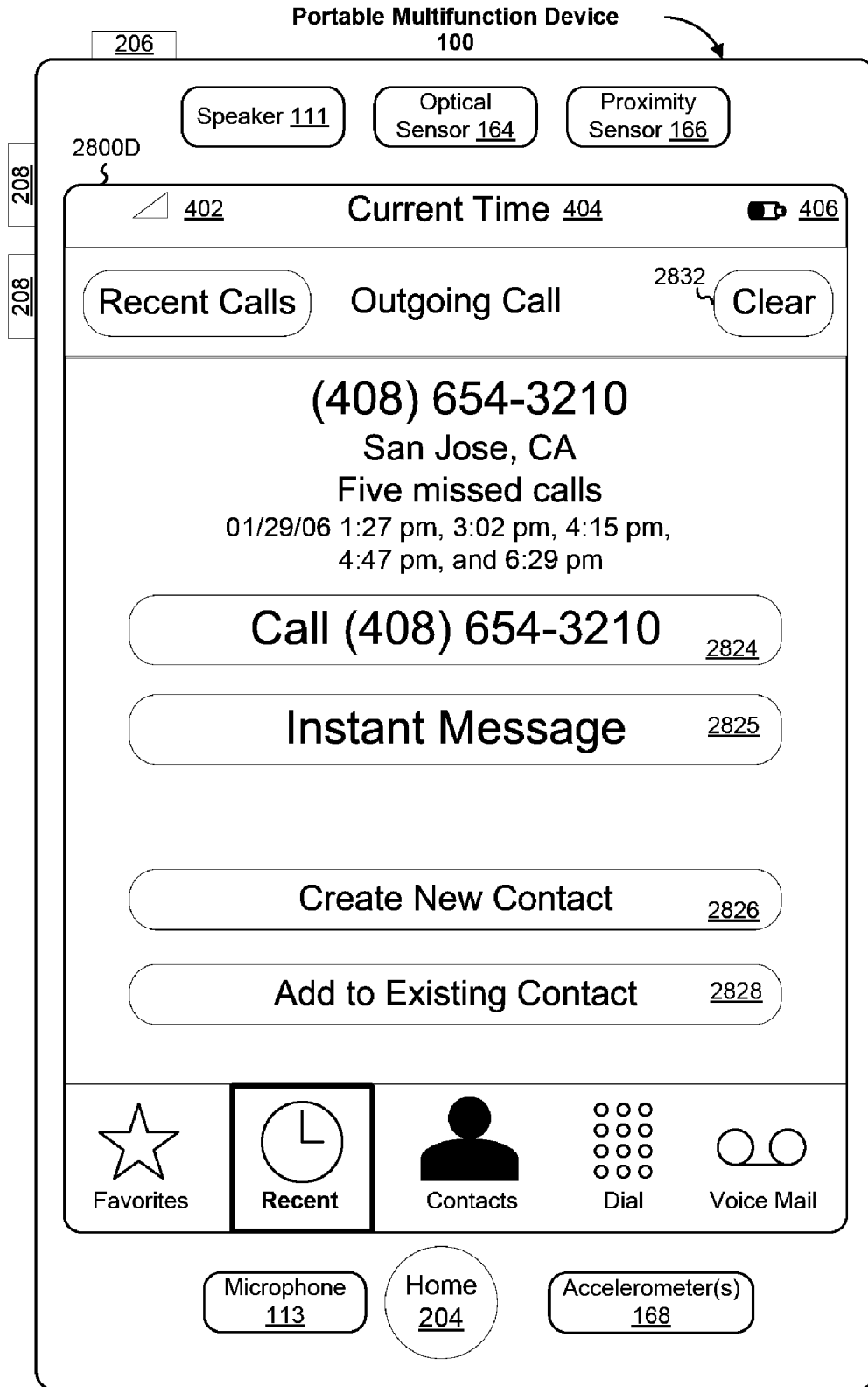

Figure 28D

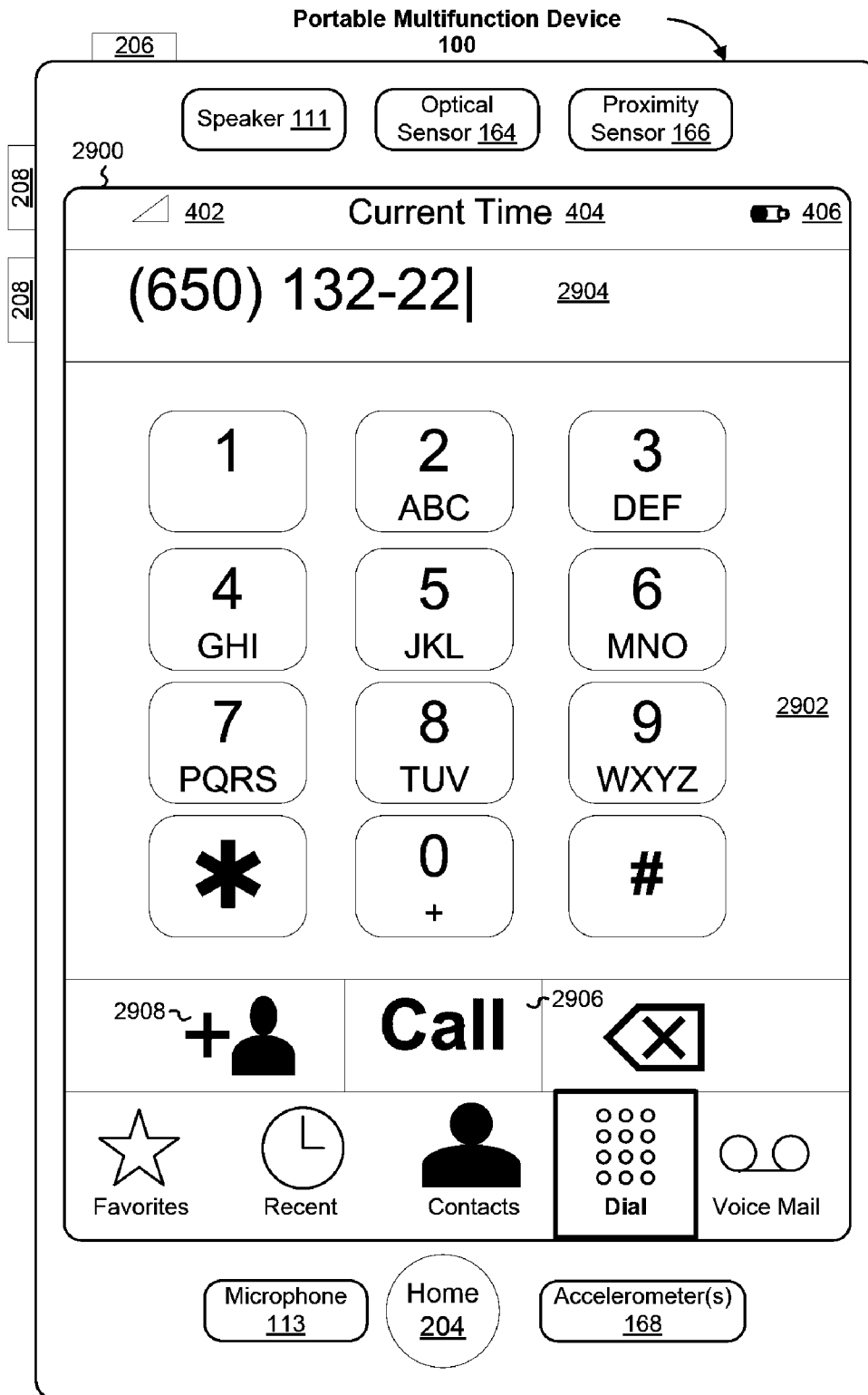

Figure 29

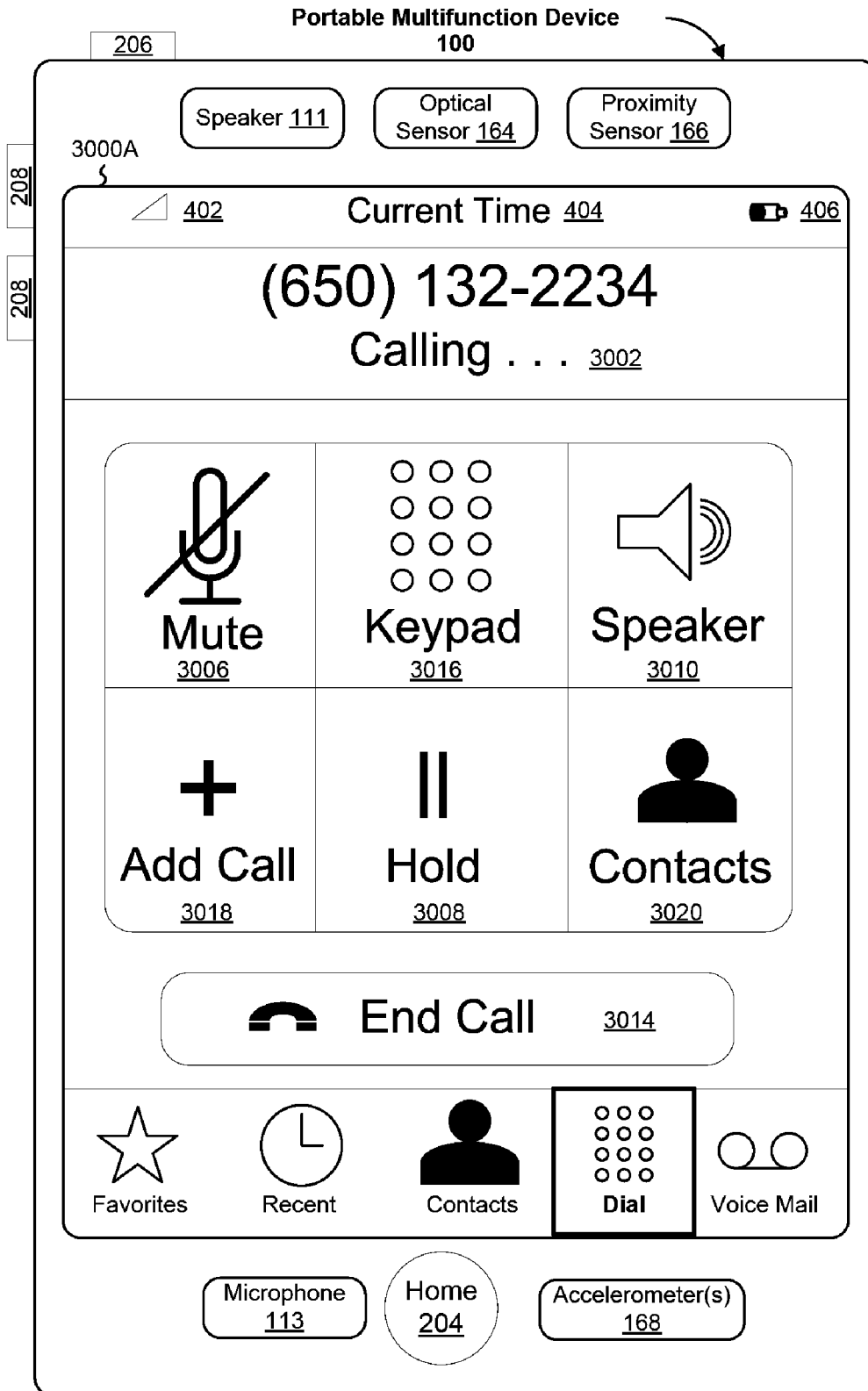

Figure 30A

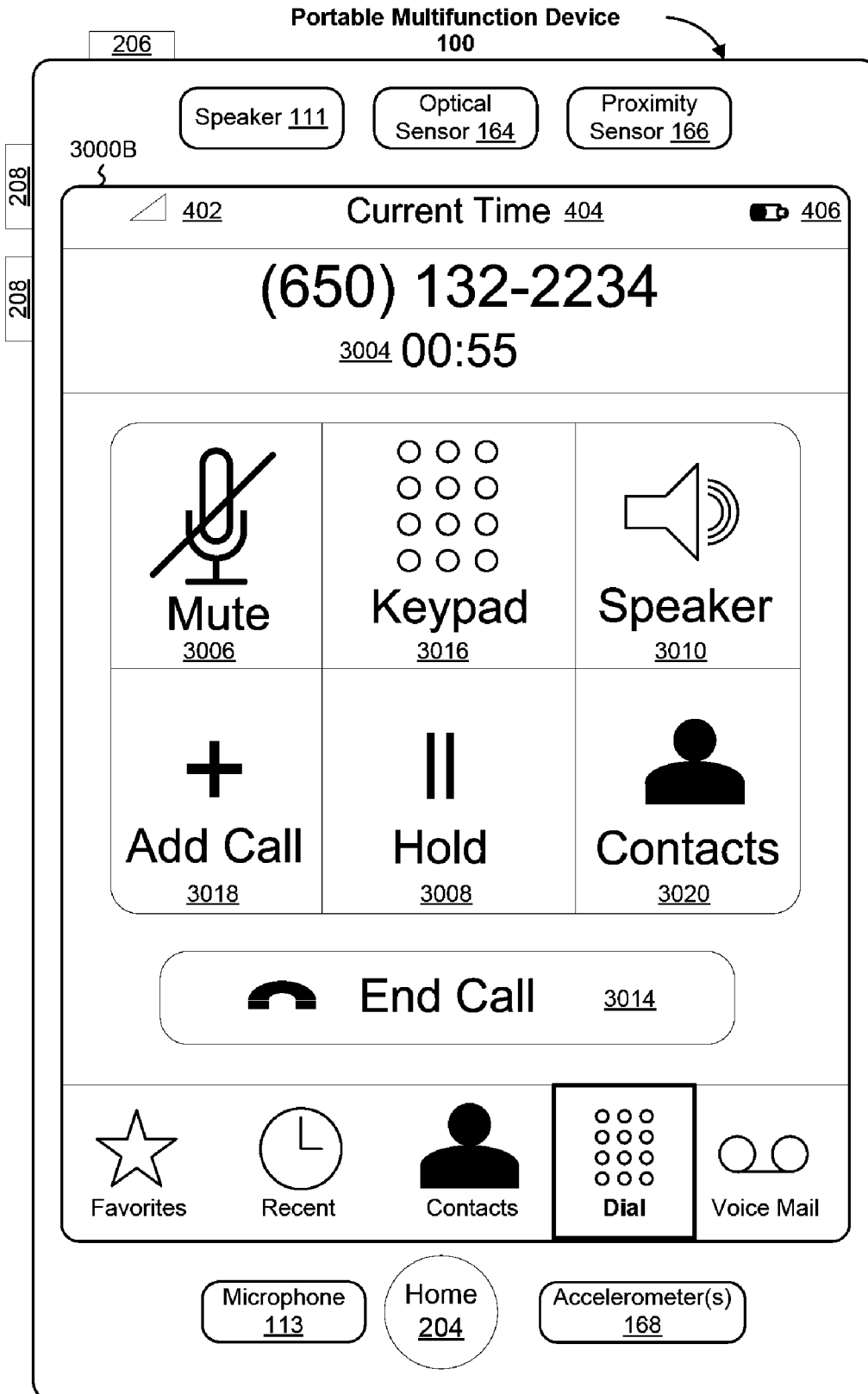

Figure 30B

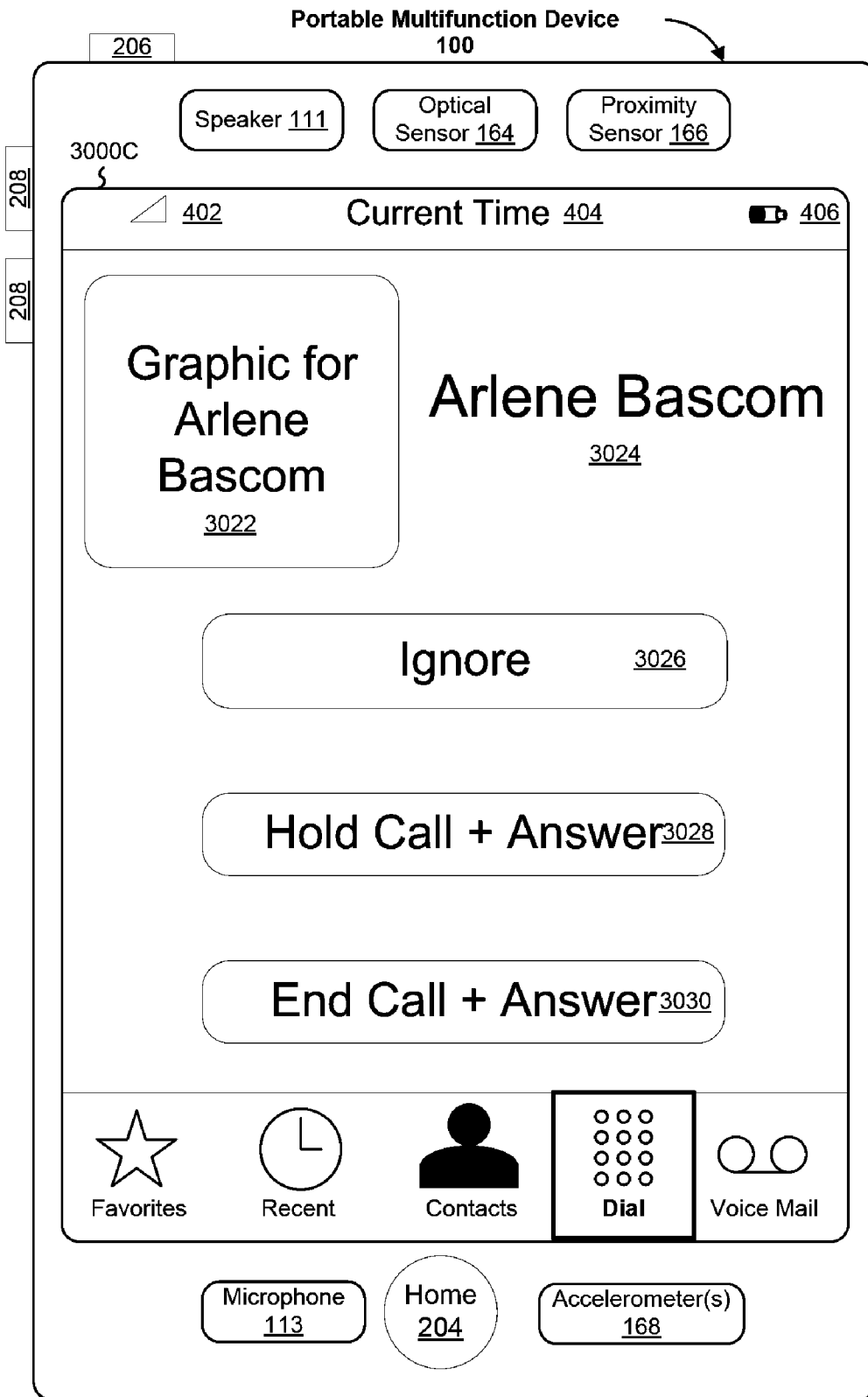

Figure 30C

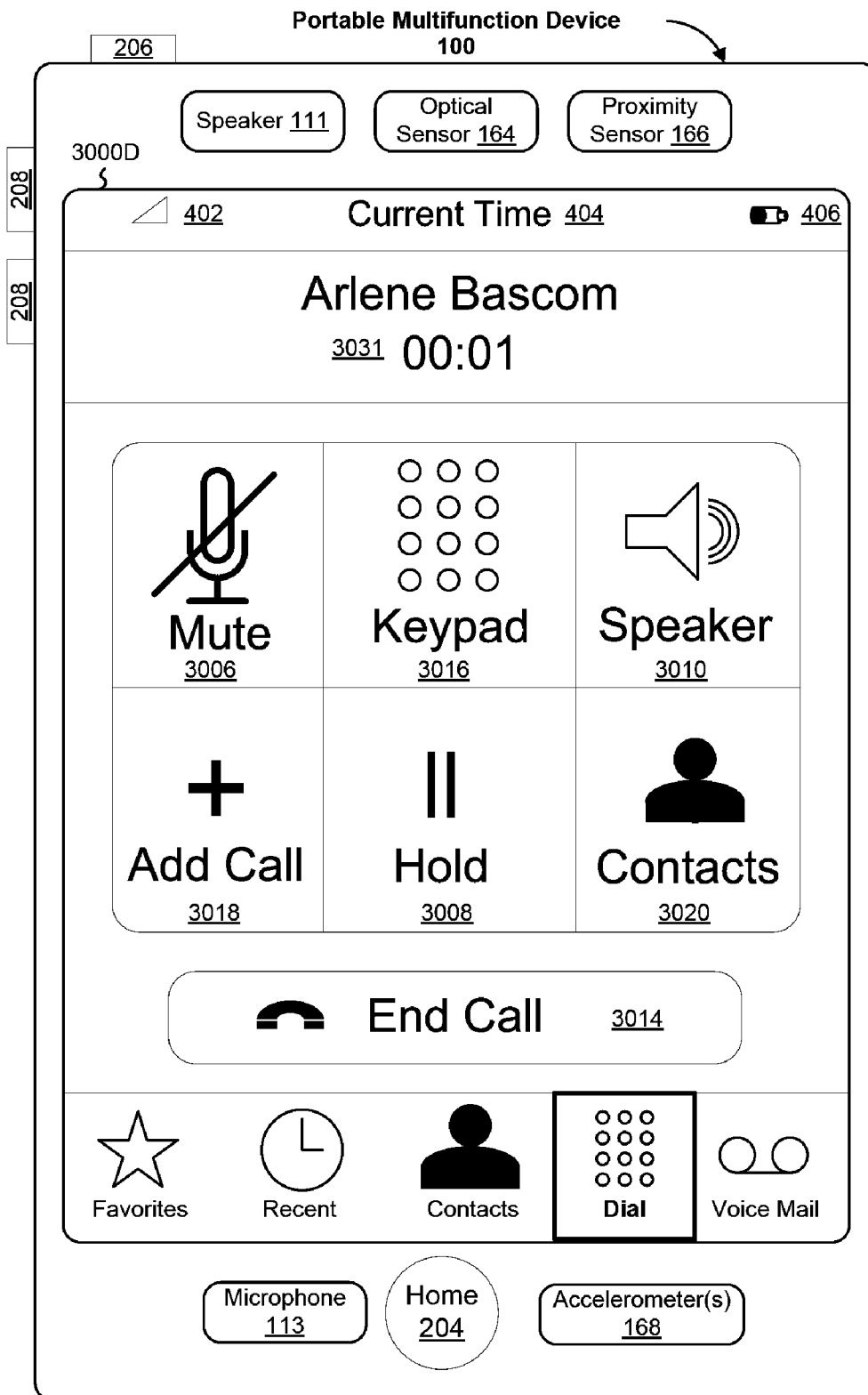

Figure 30D

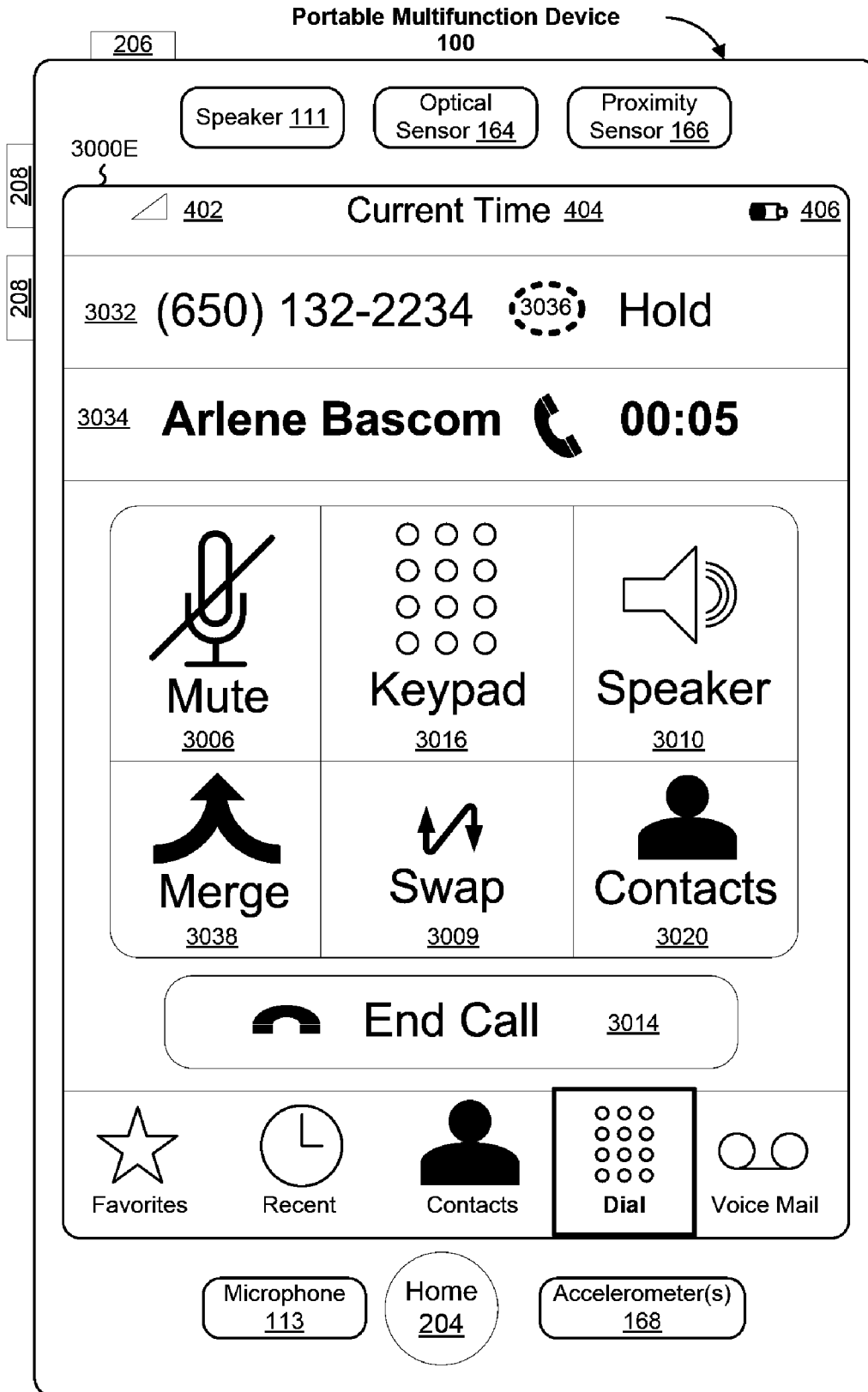

Figure 30E

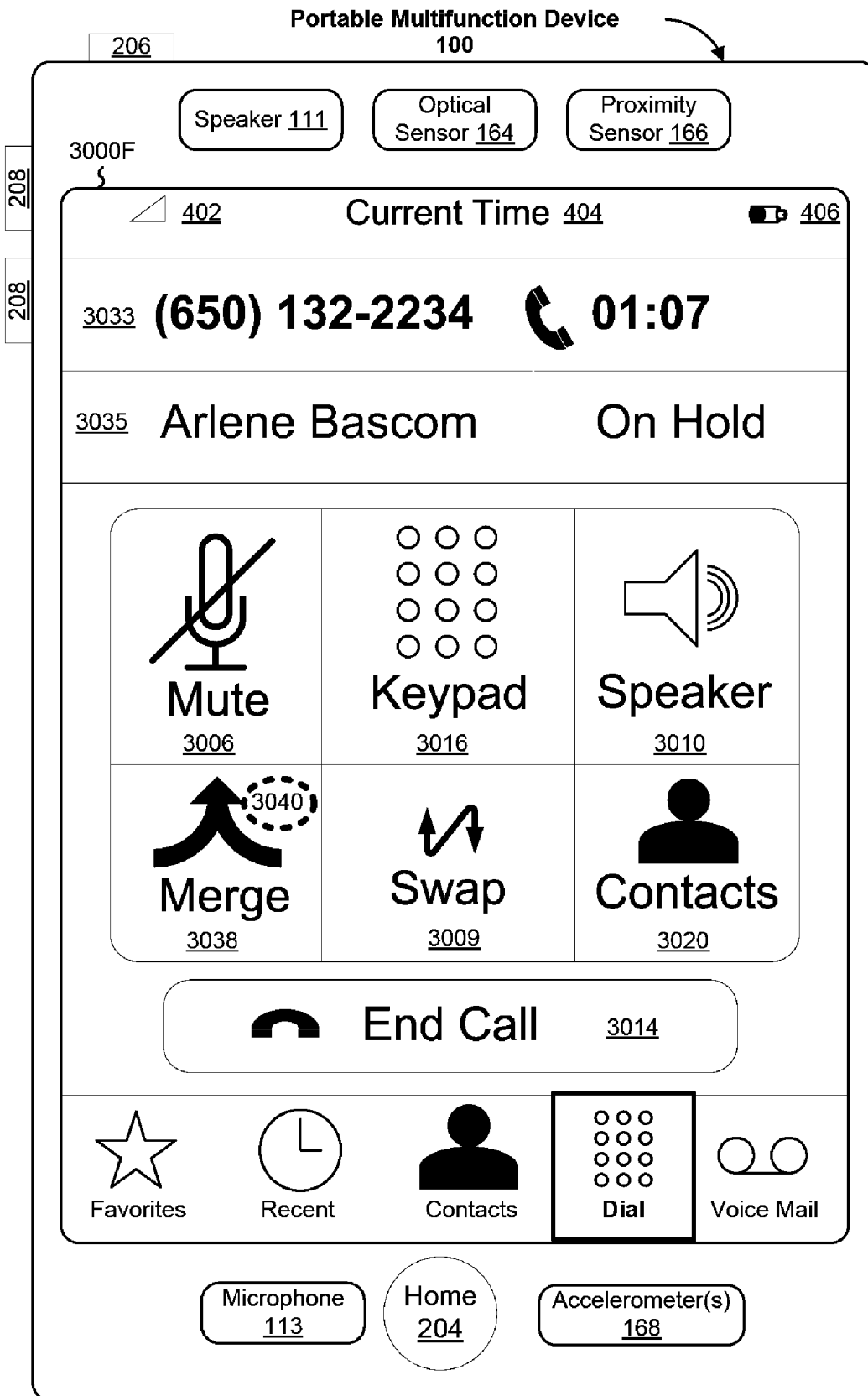

Figure 30F



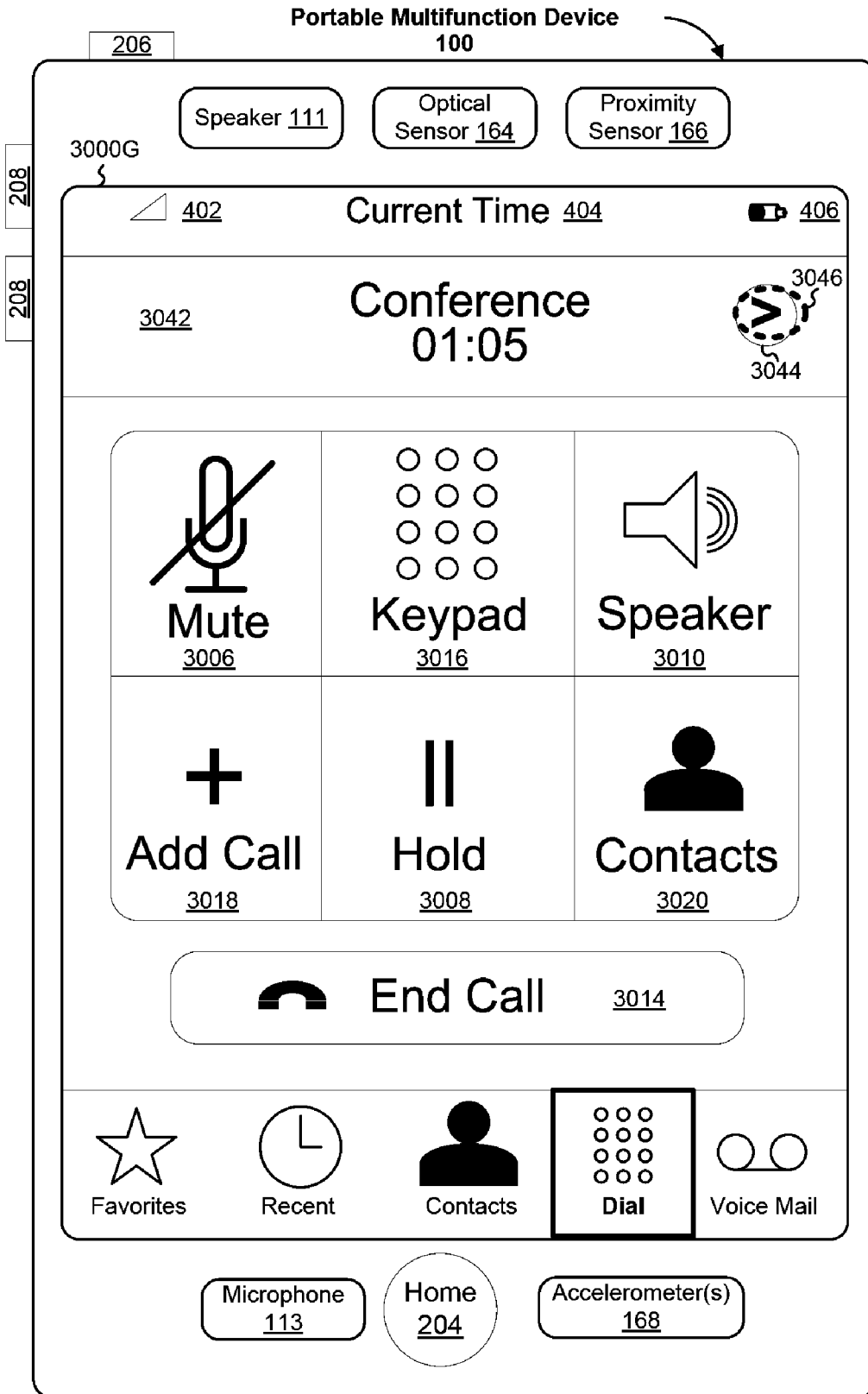

Figure 30G



Figure 30H

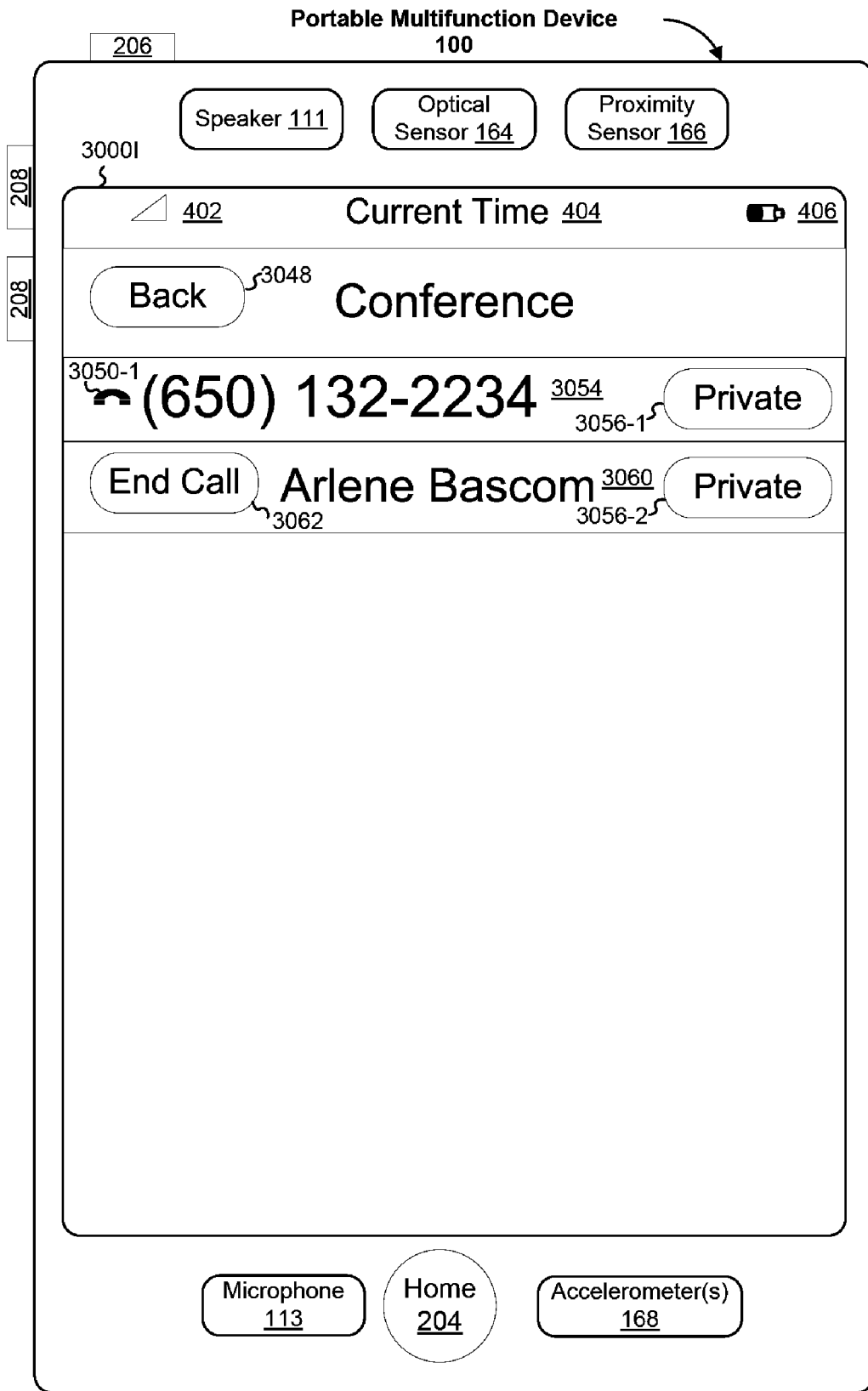

Figure 30I

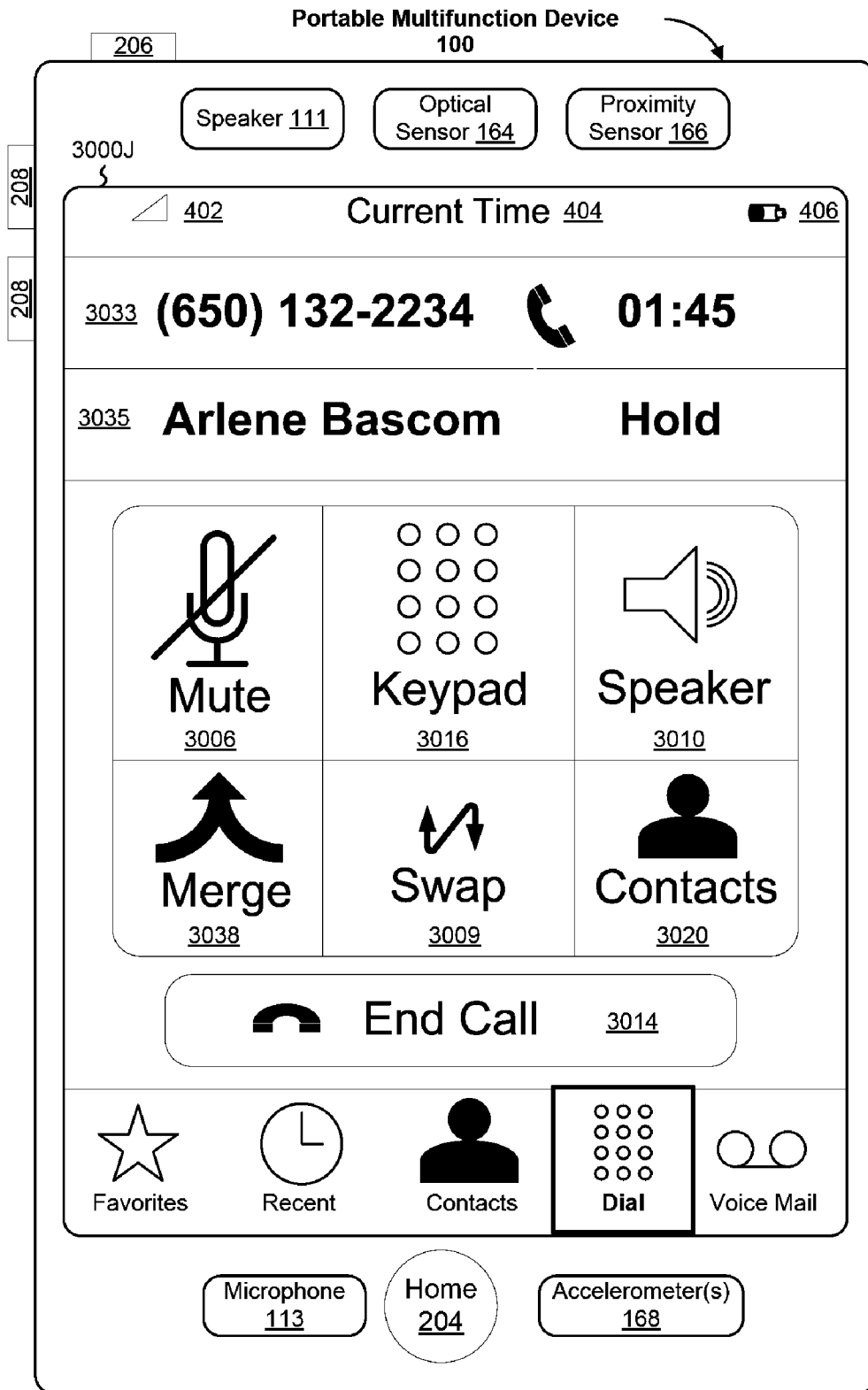

Figure 30J

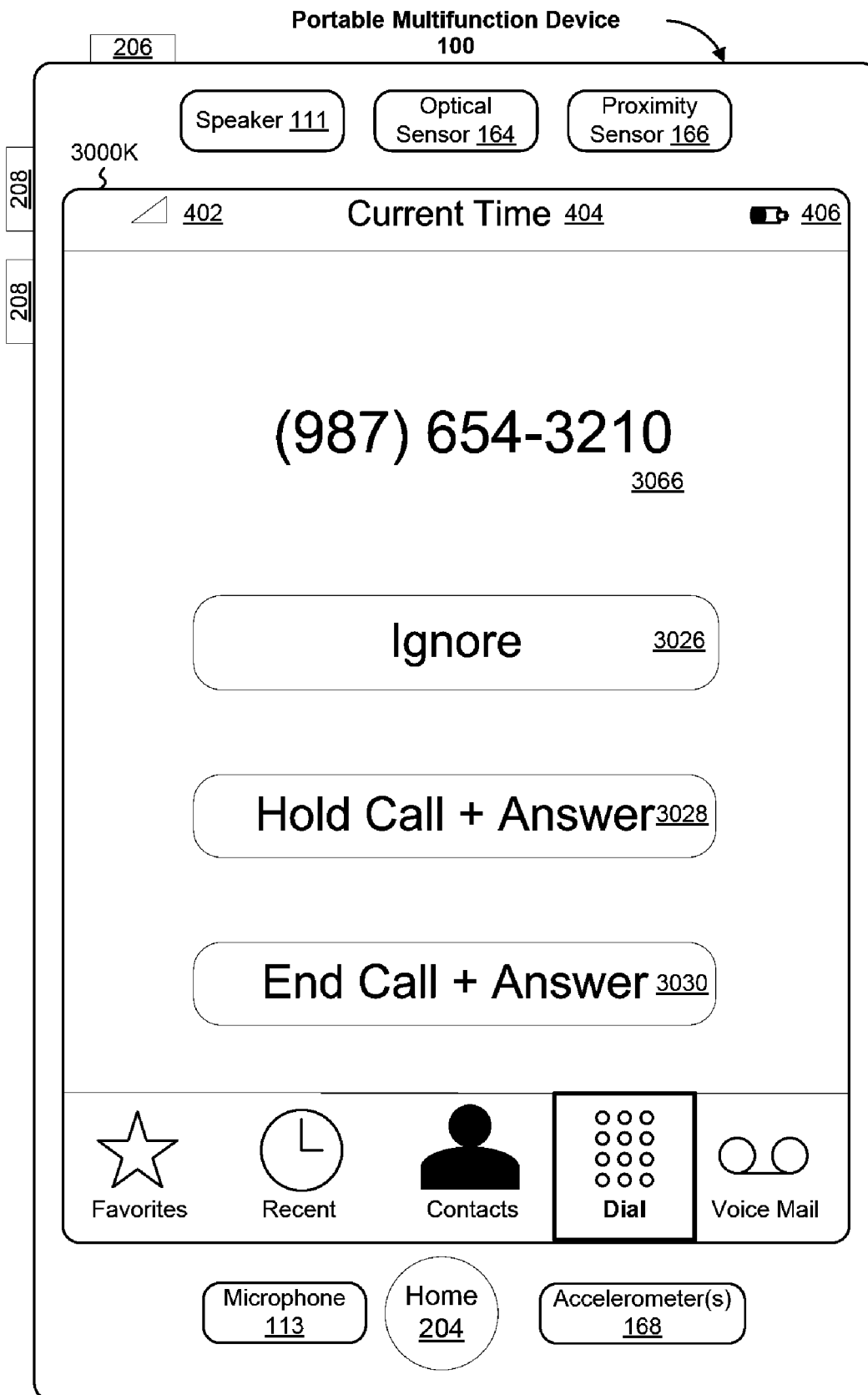

Figure 30K

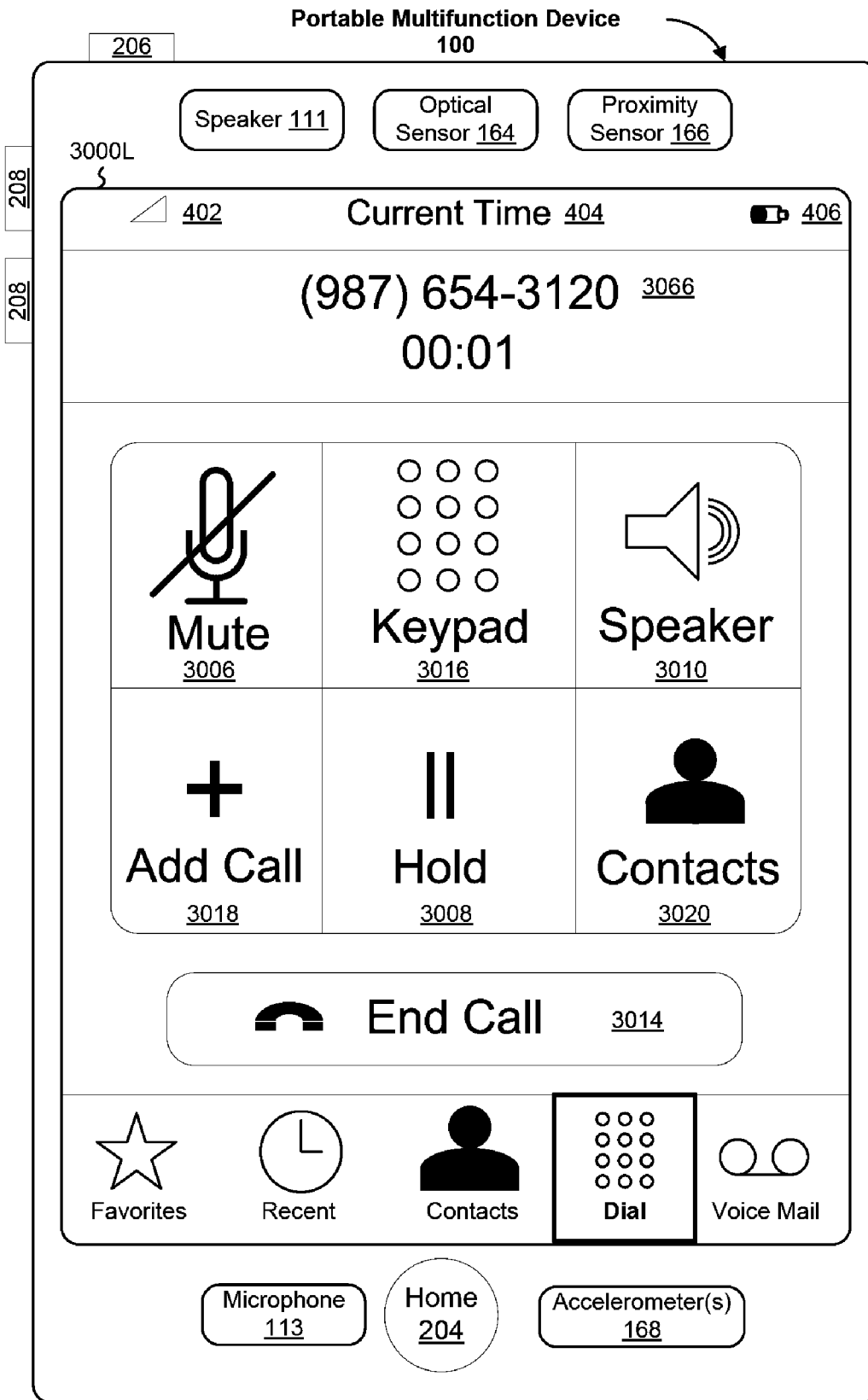

Figure 30L

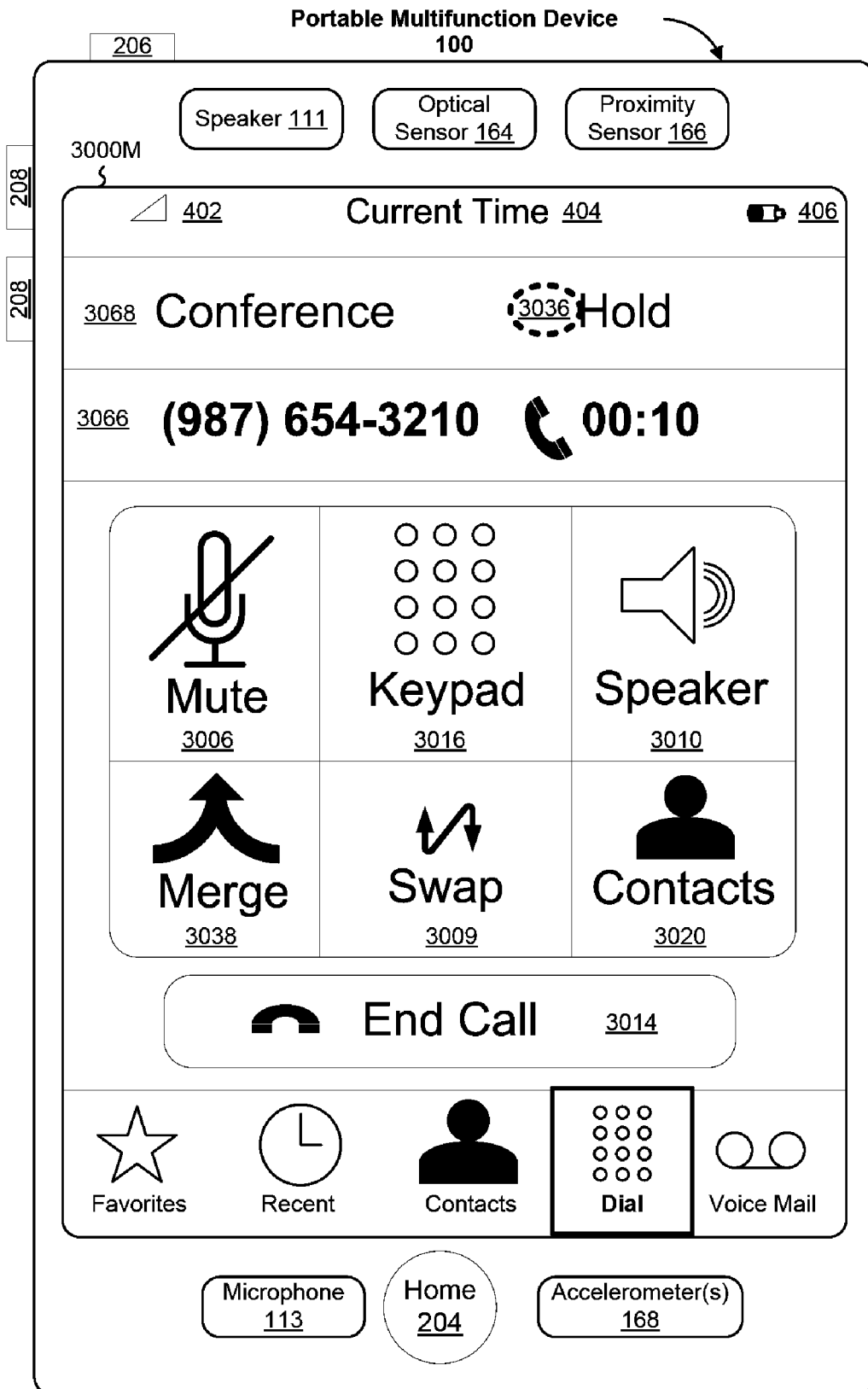

Figure 30M

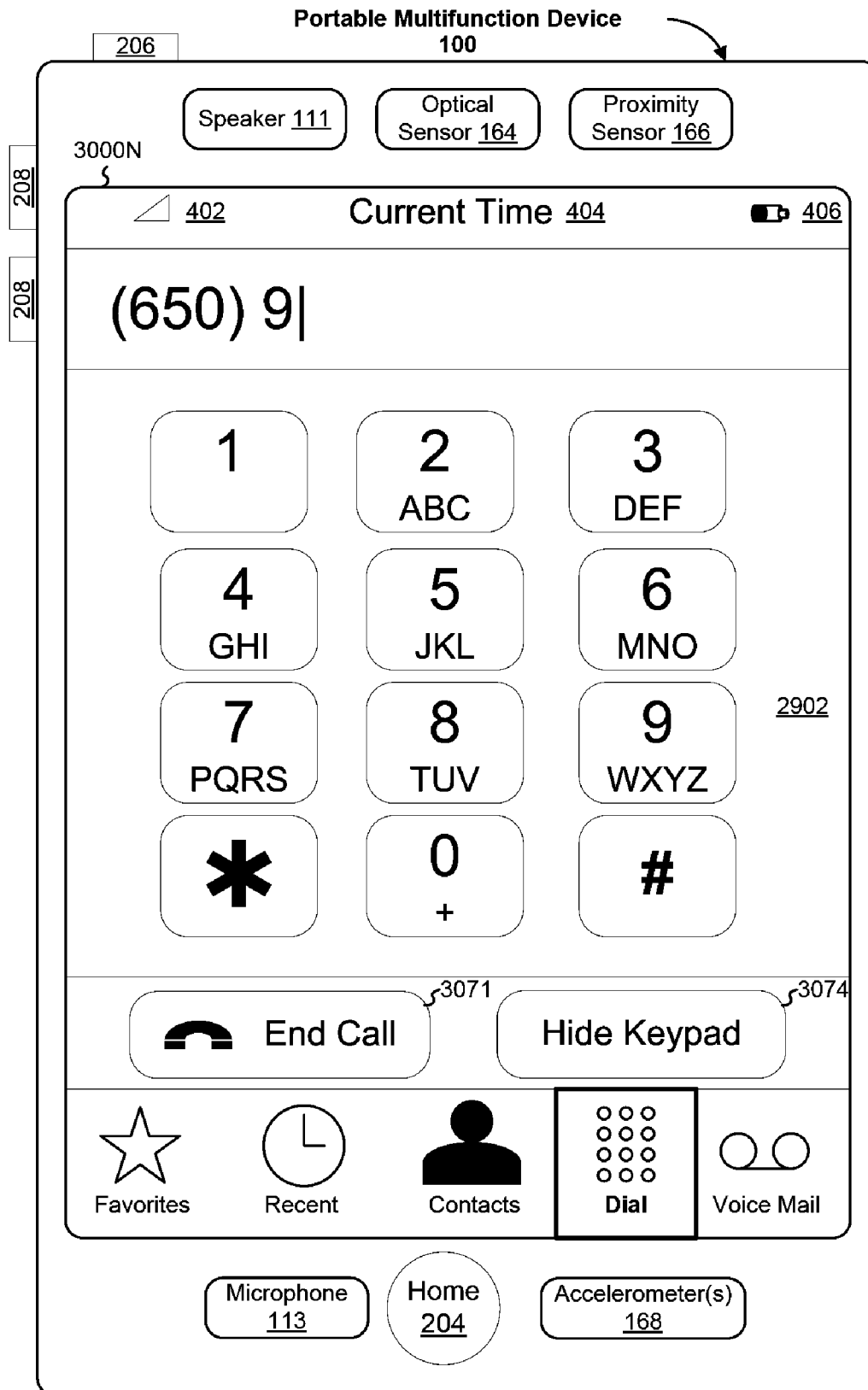

Figure 30N



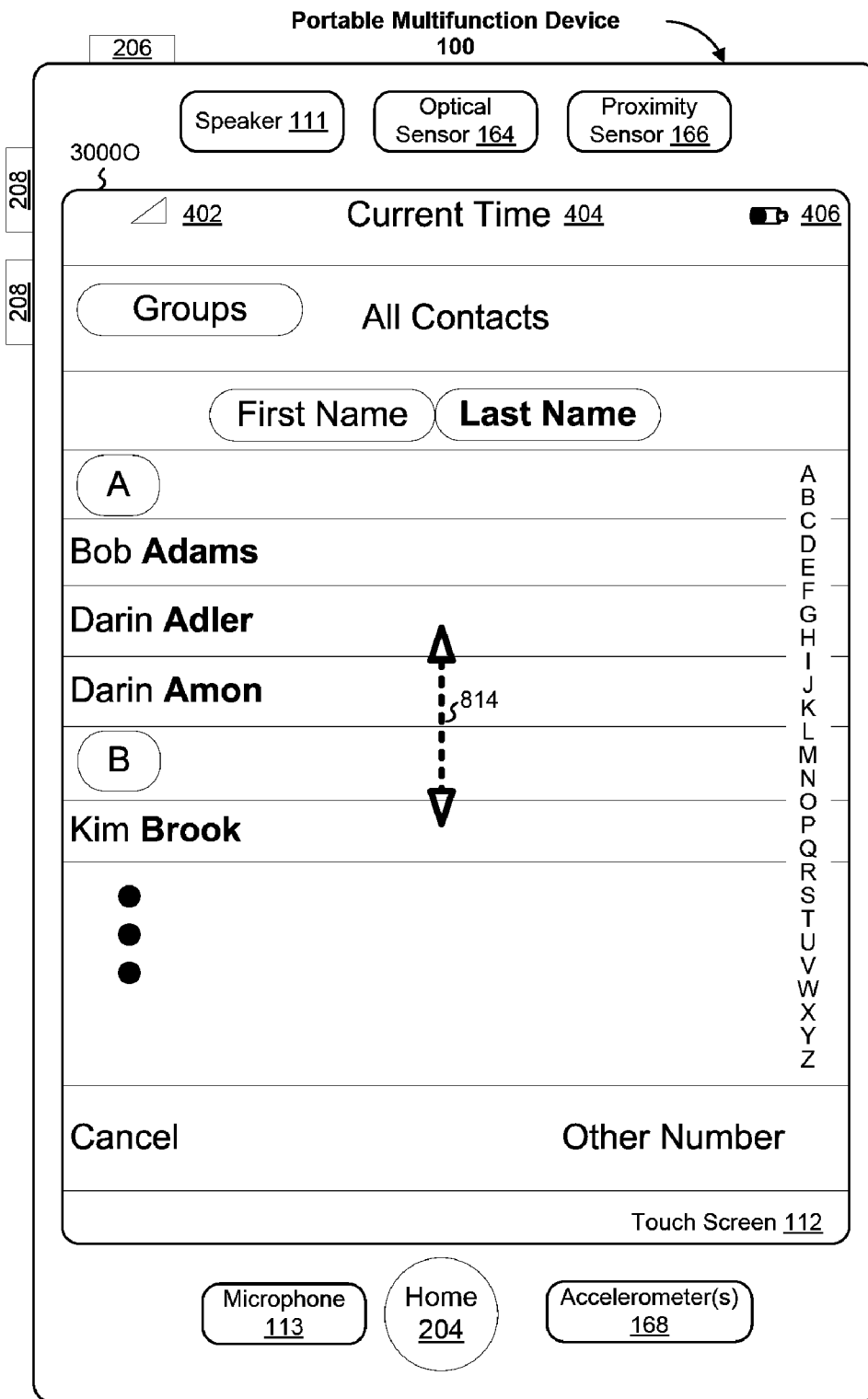

Figure 300

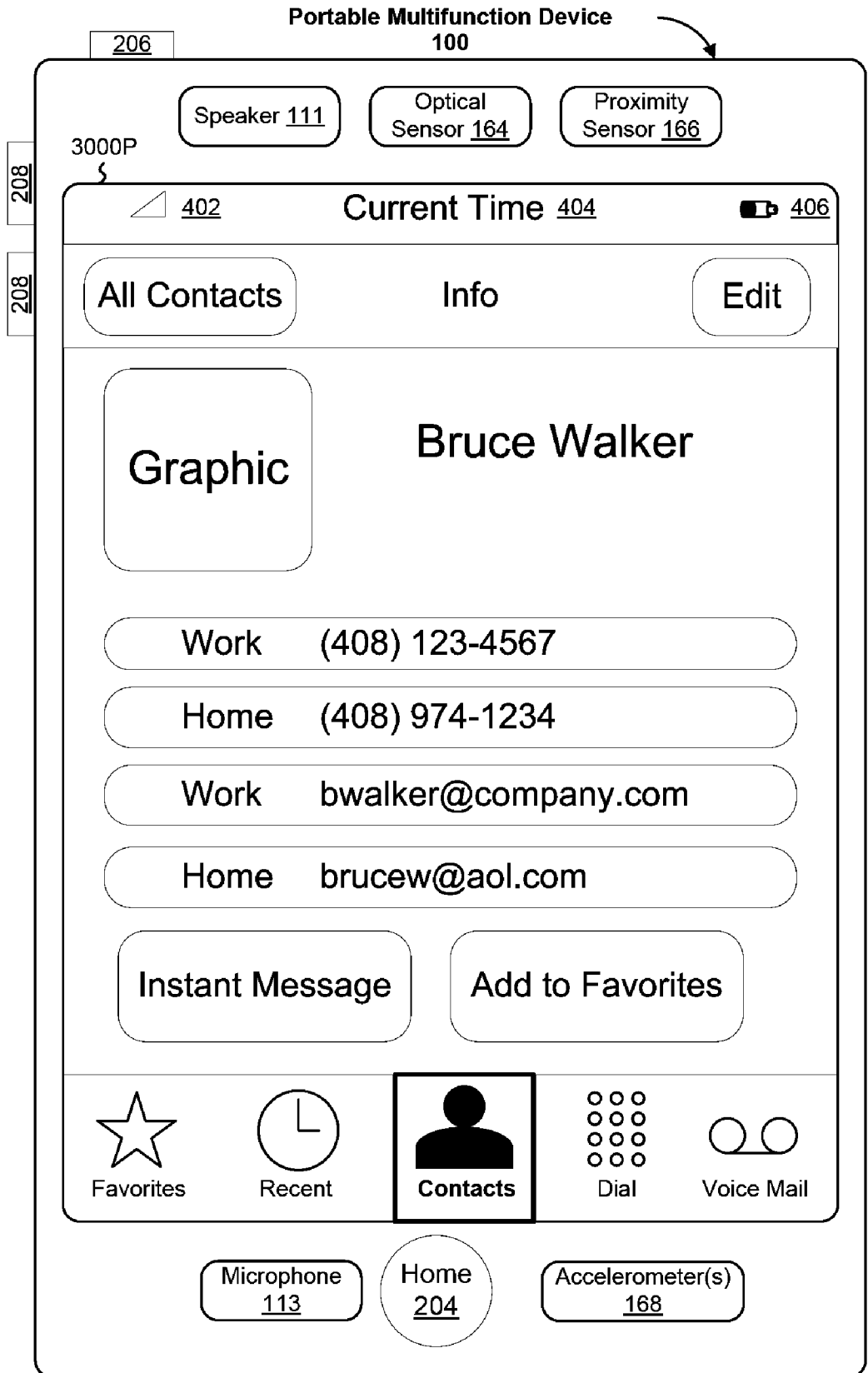

Figure 30P

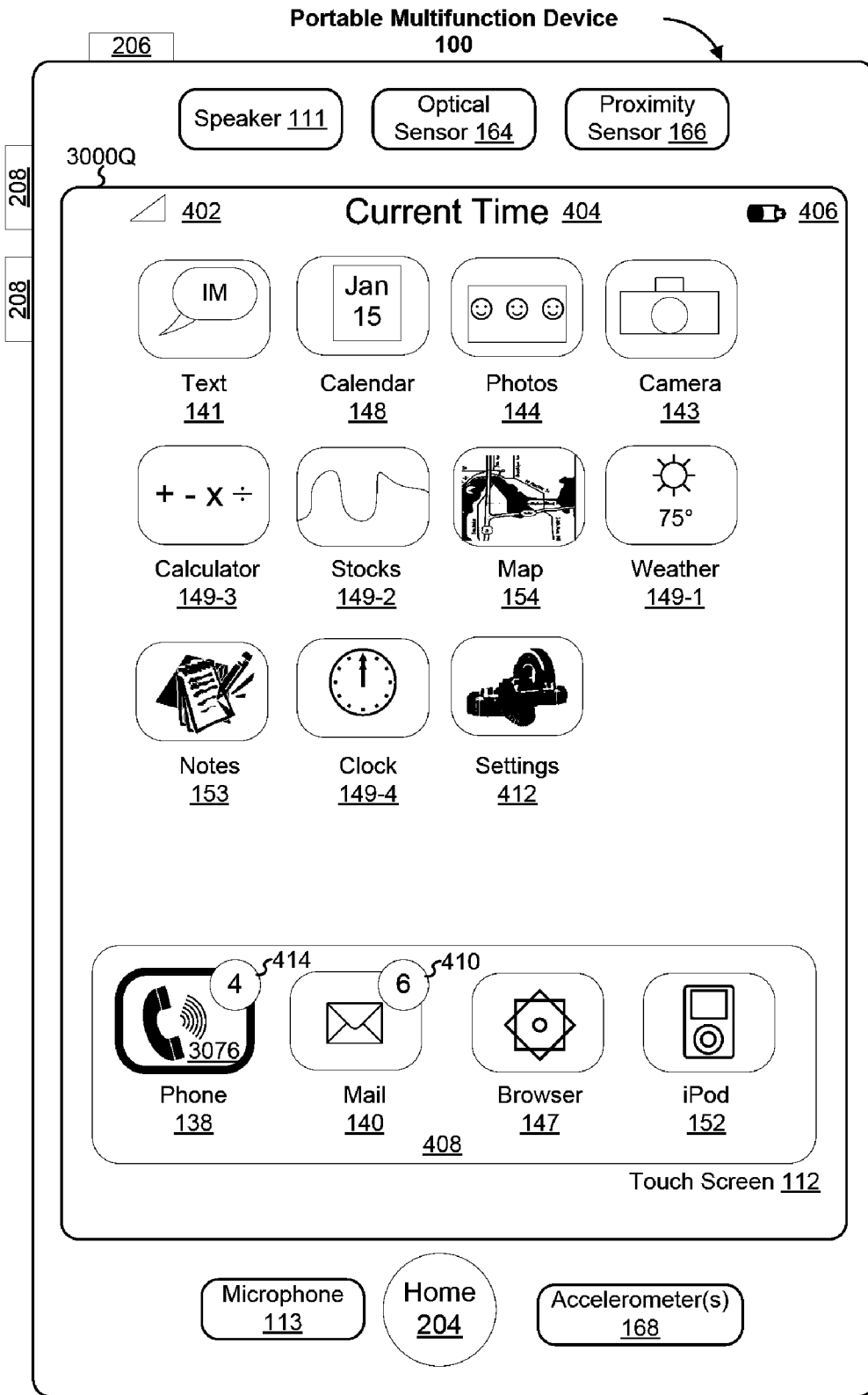

Figure 30Q

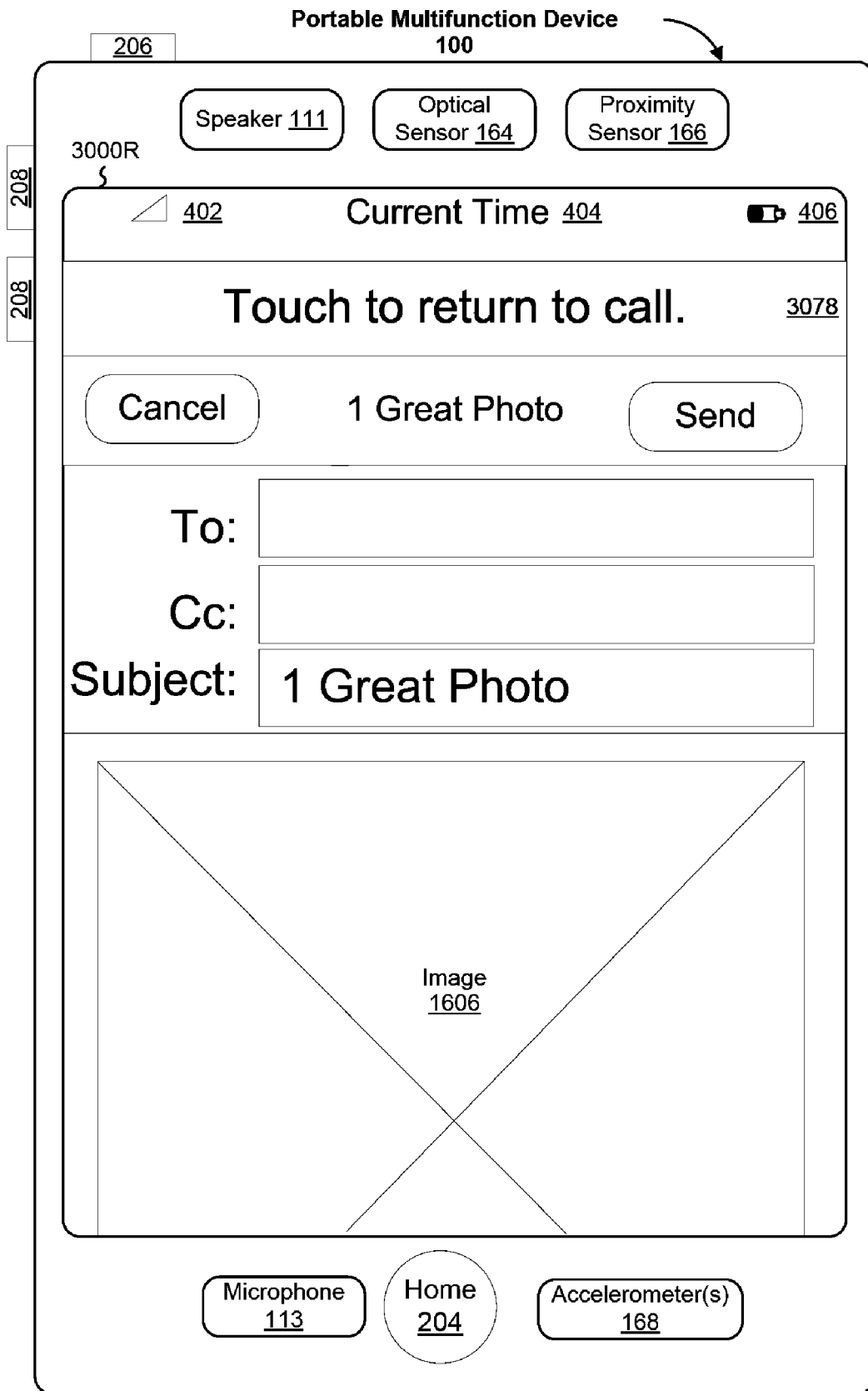

Figure 30R

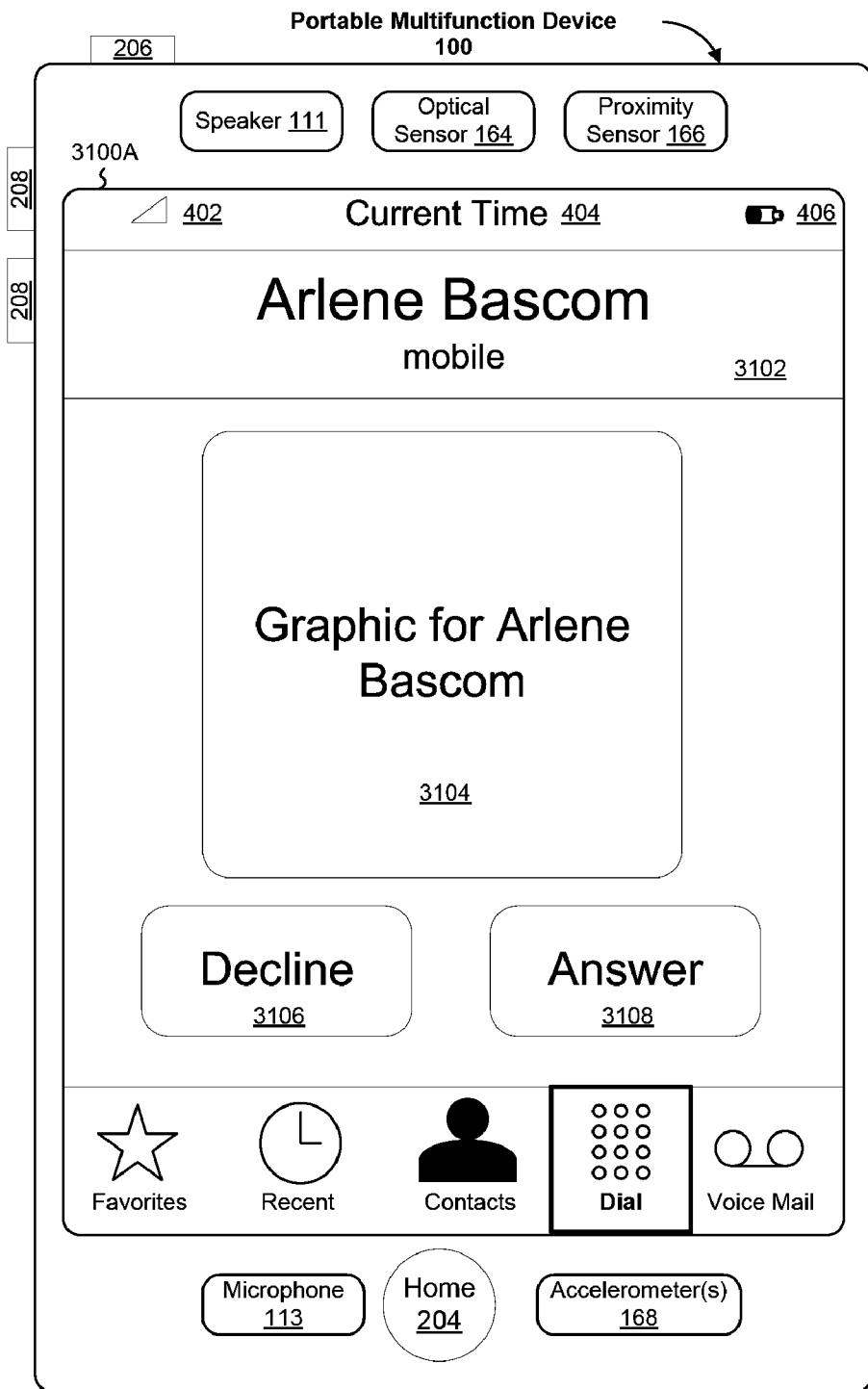

Figure 31A



Figure 31B

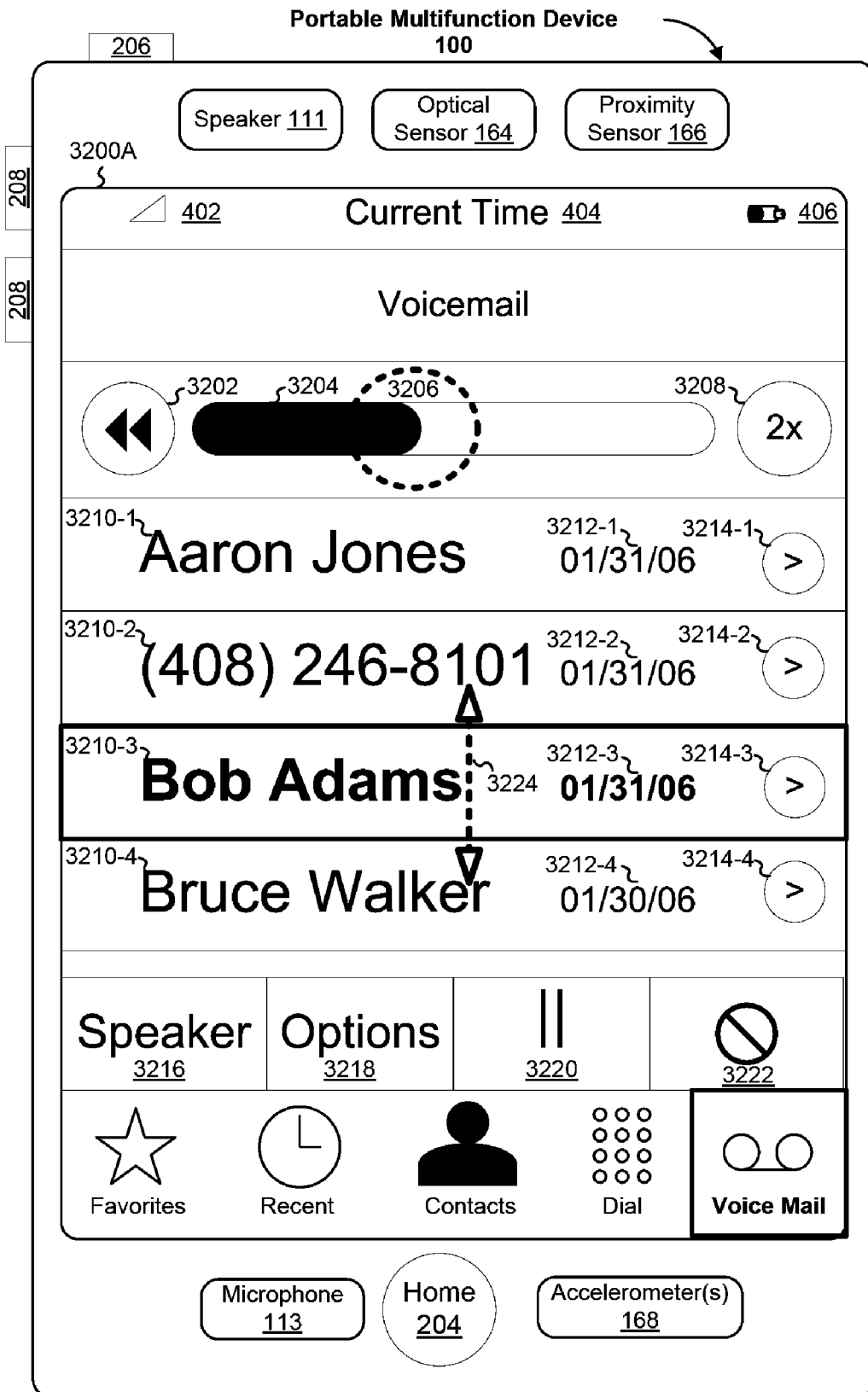

Figure 32A

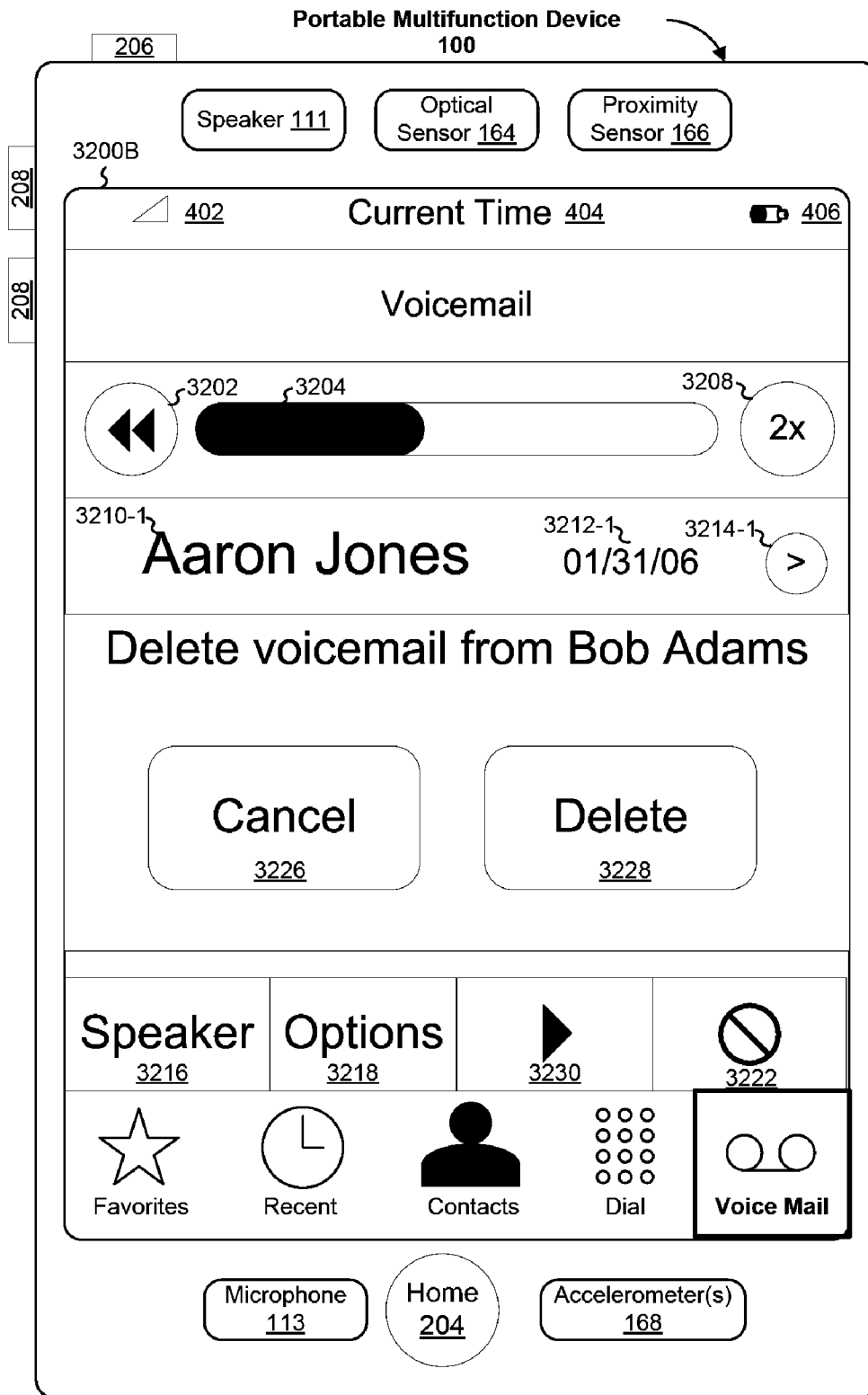

Figure 32B



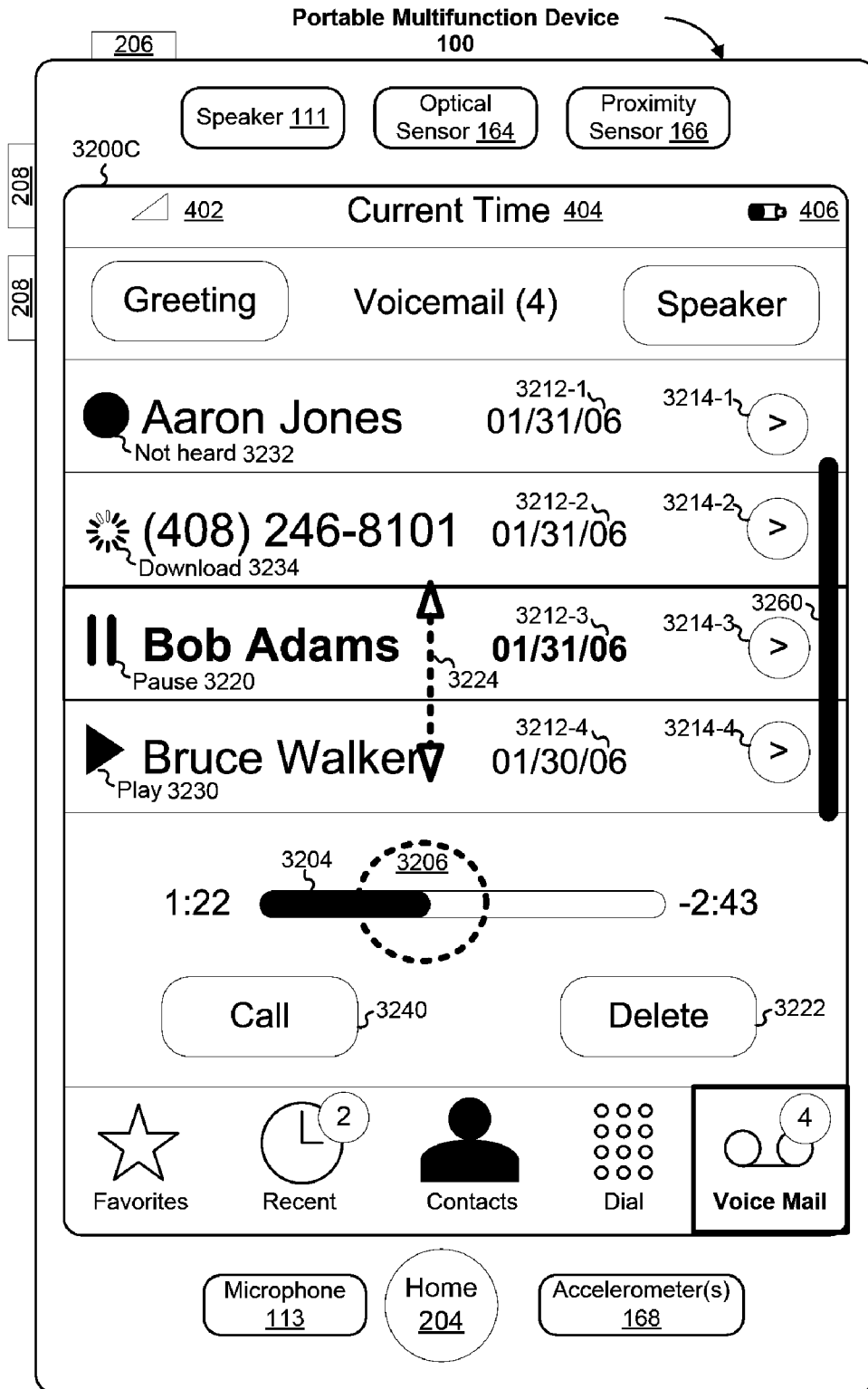

Figure 32C

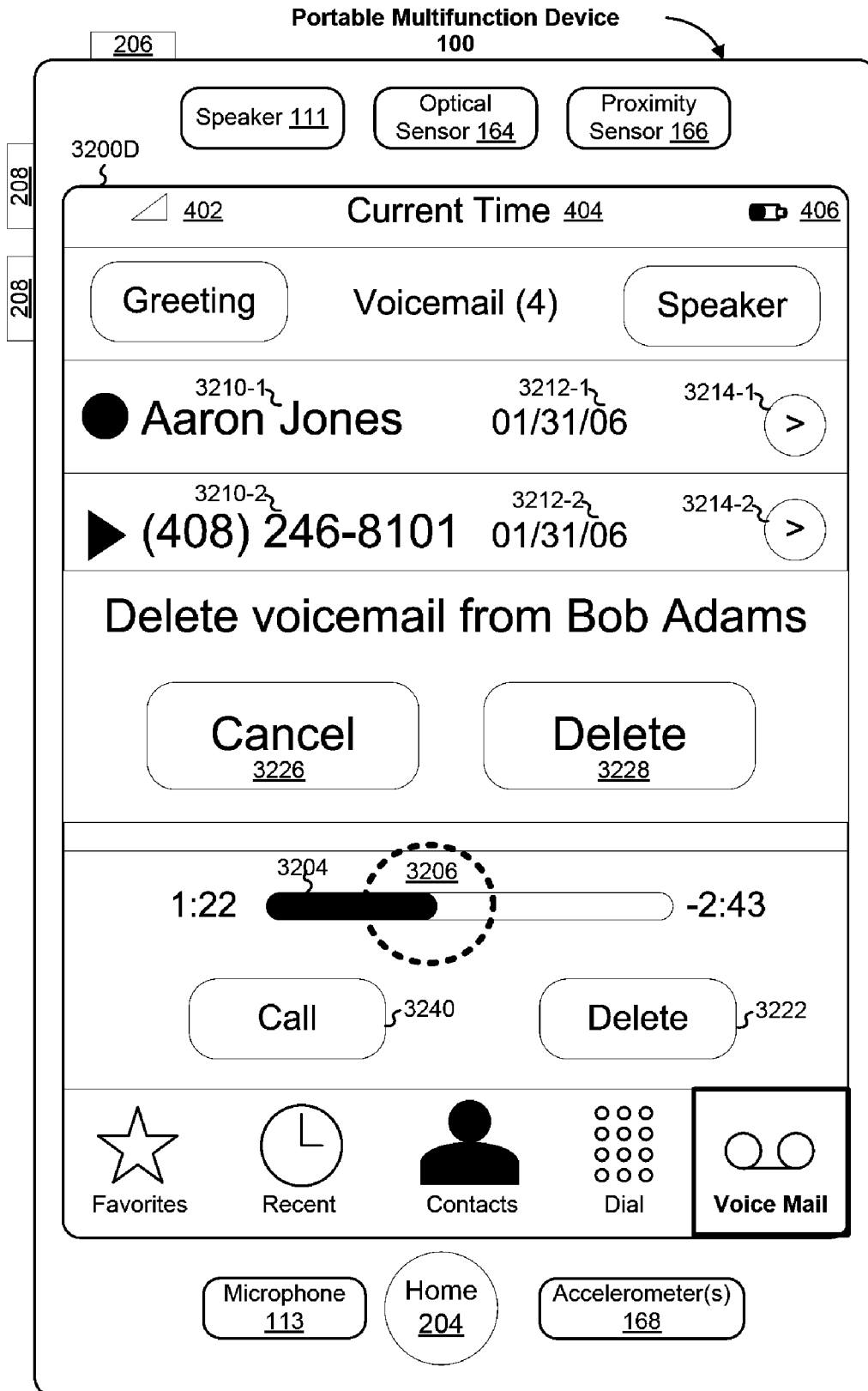

Figure 32D

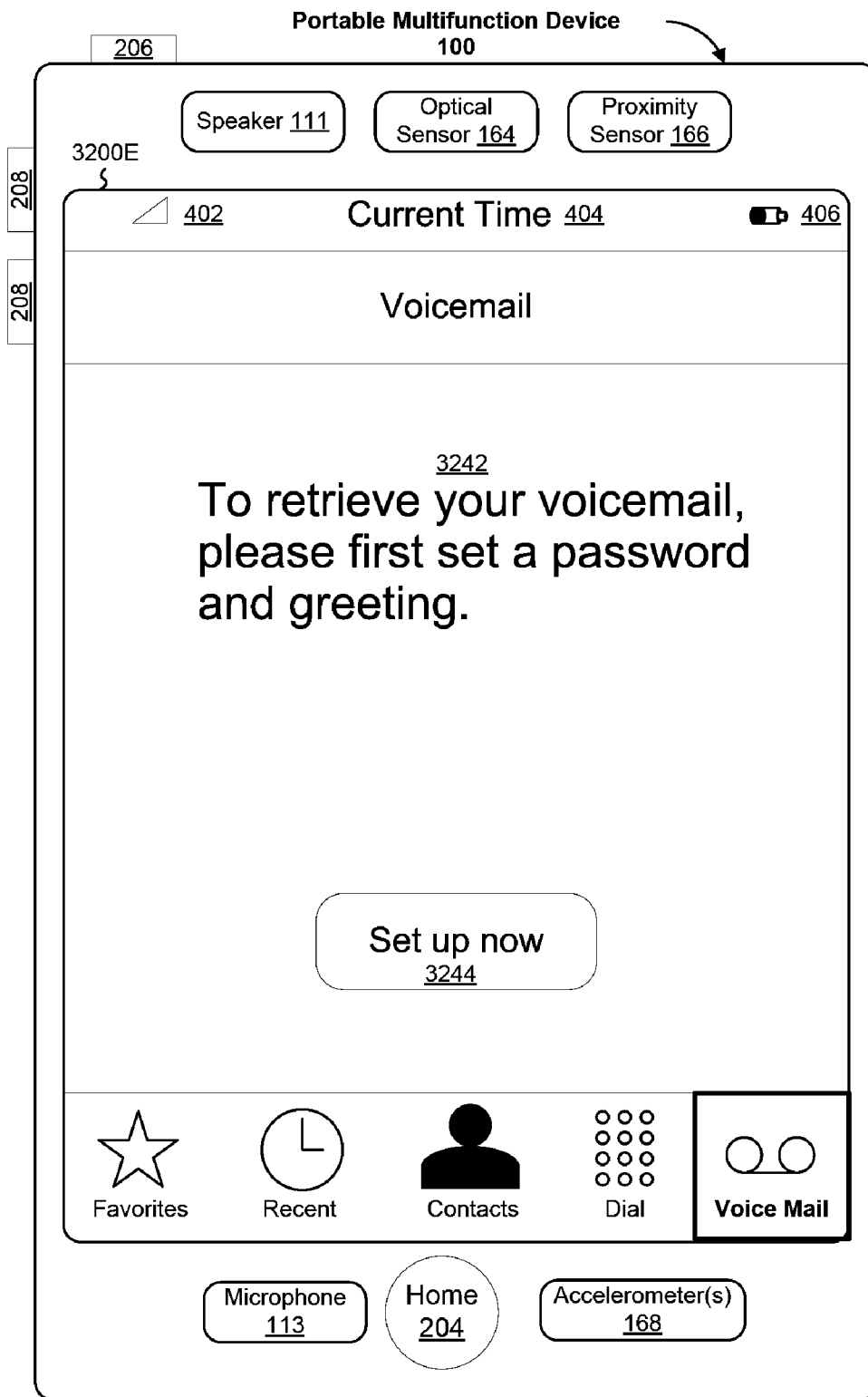

Figure 32E

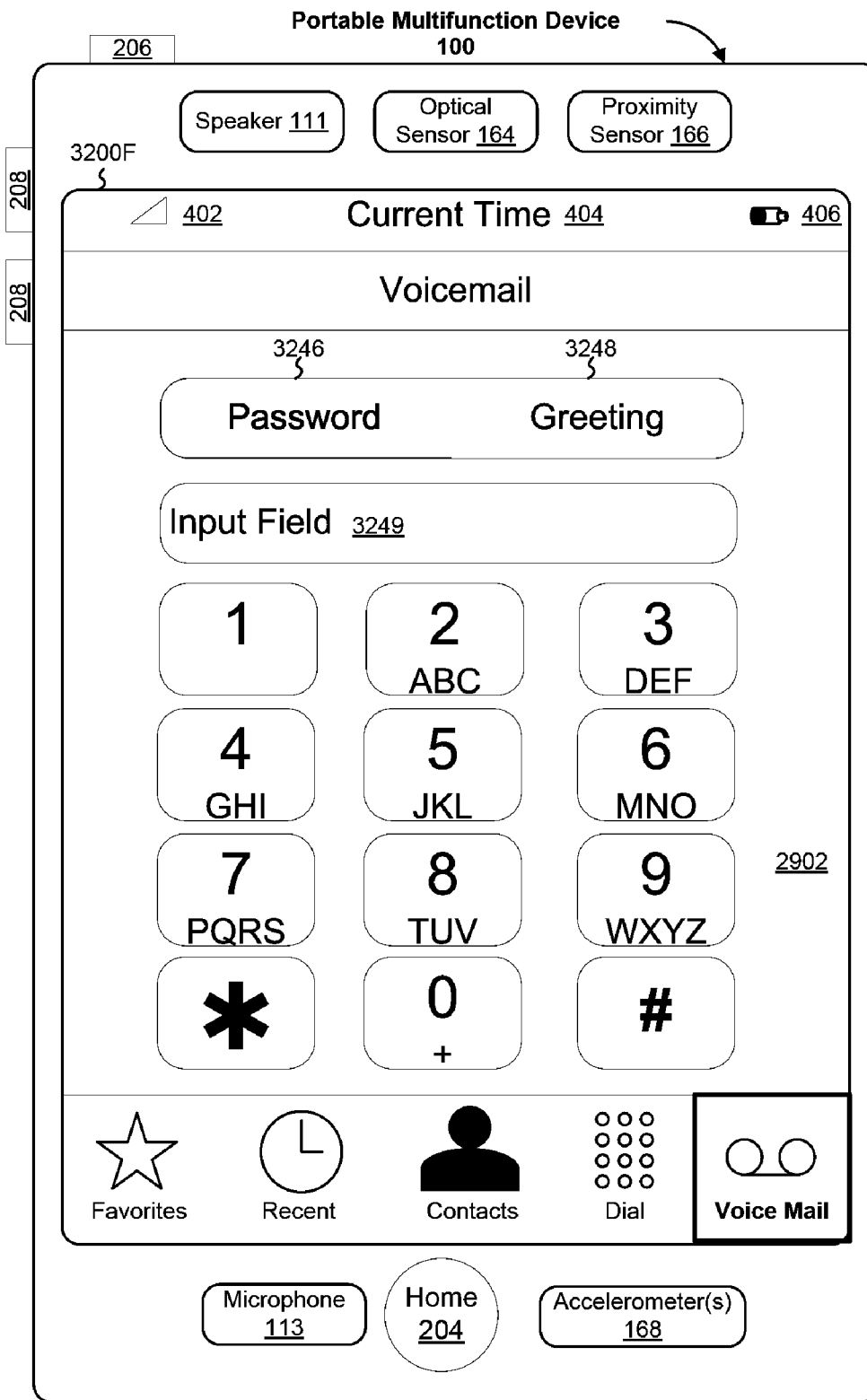

Figure 32F

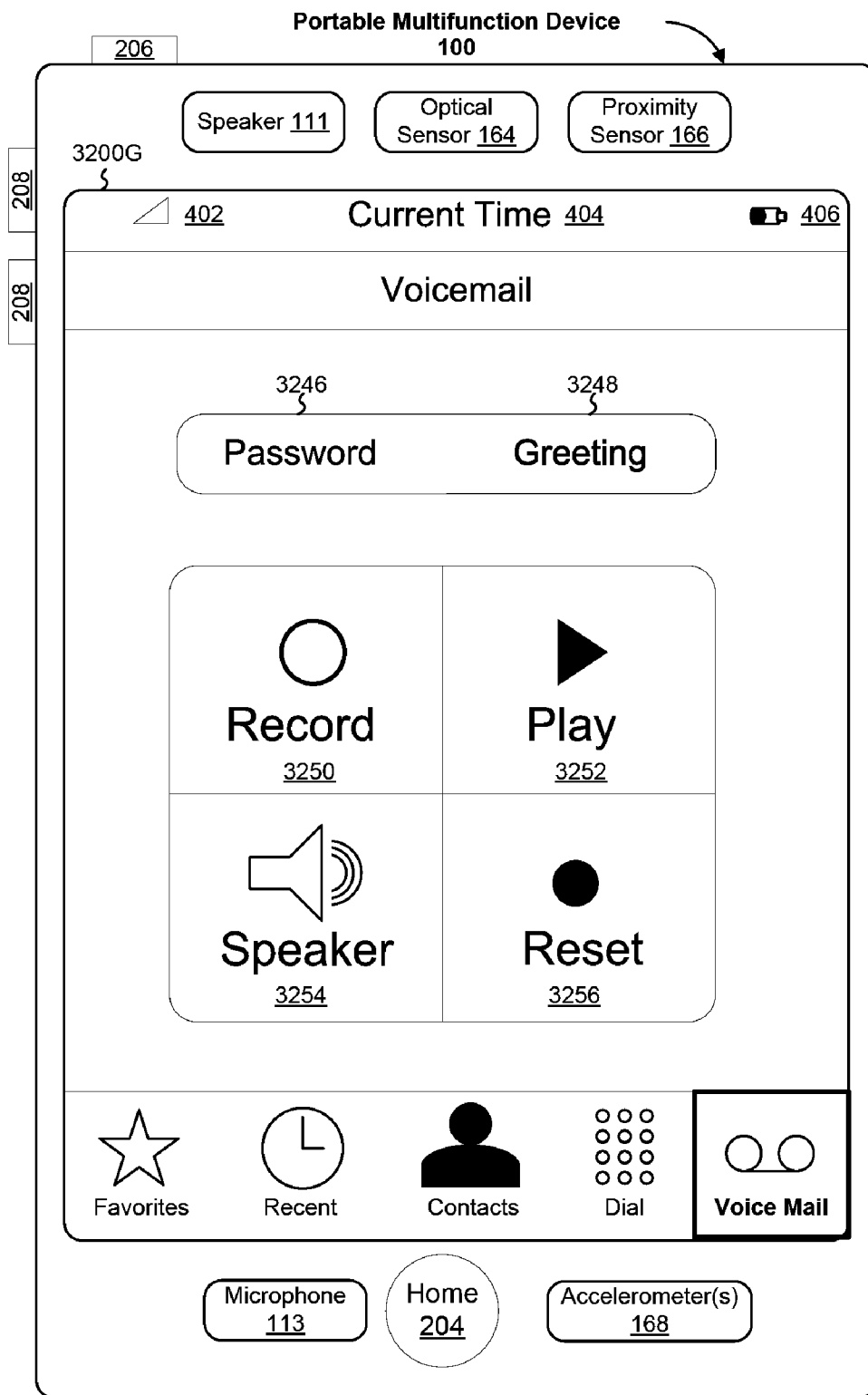

Figure 32G

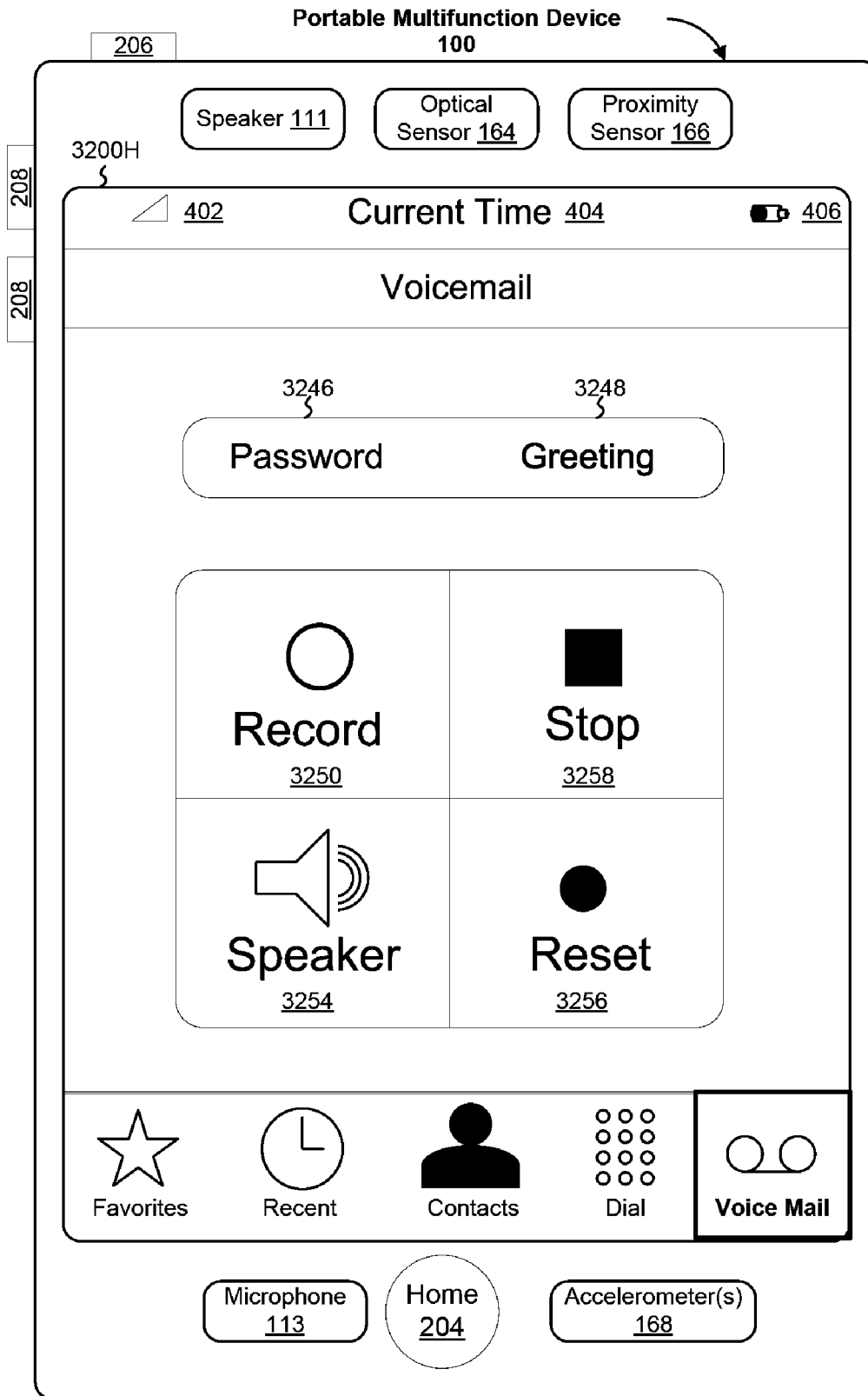

Figure 32H



Figure 33

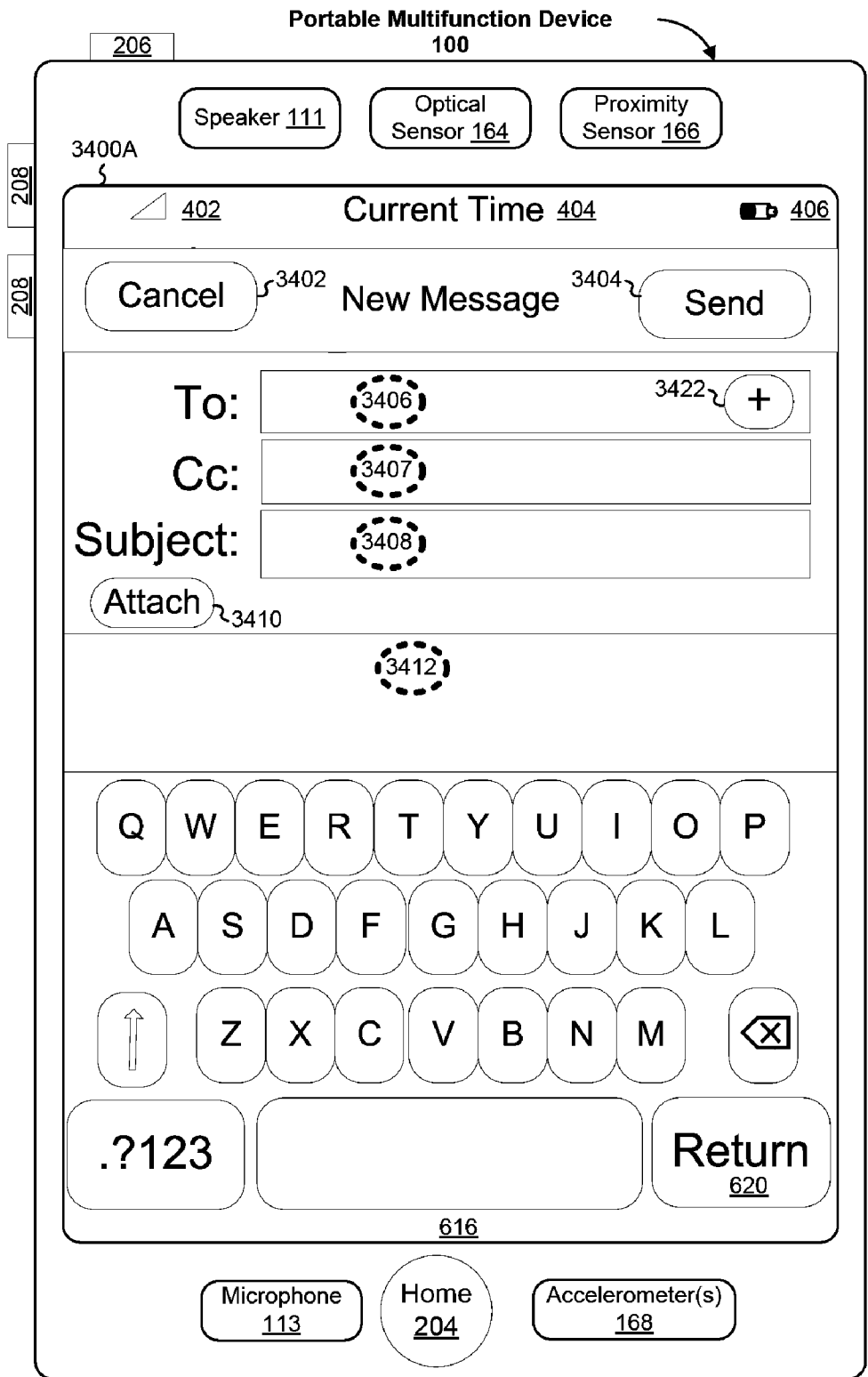

Figure 34A



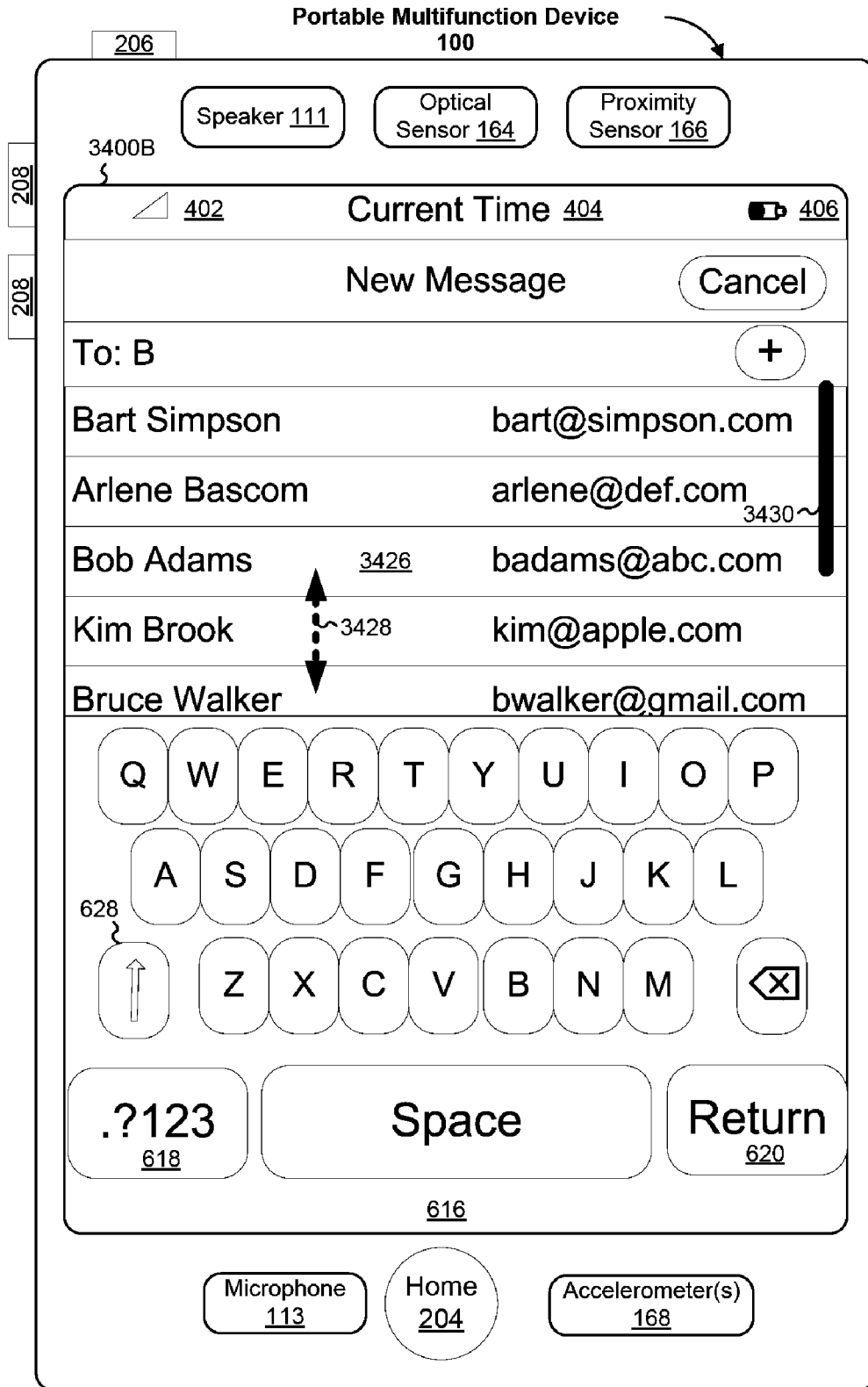

Figure 34B

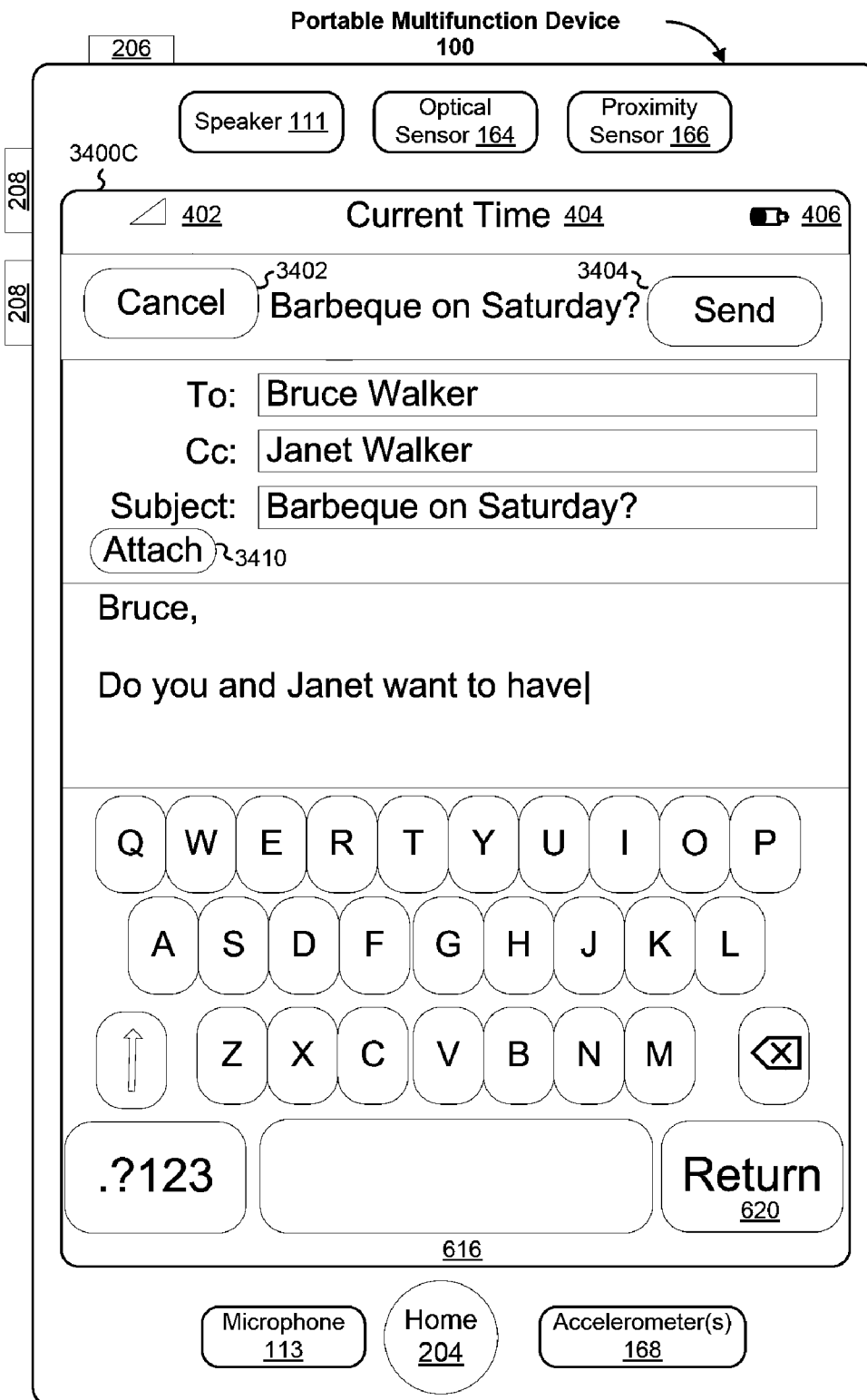

Figure 34C

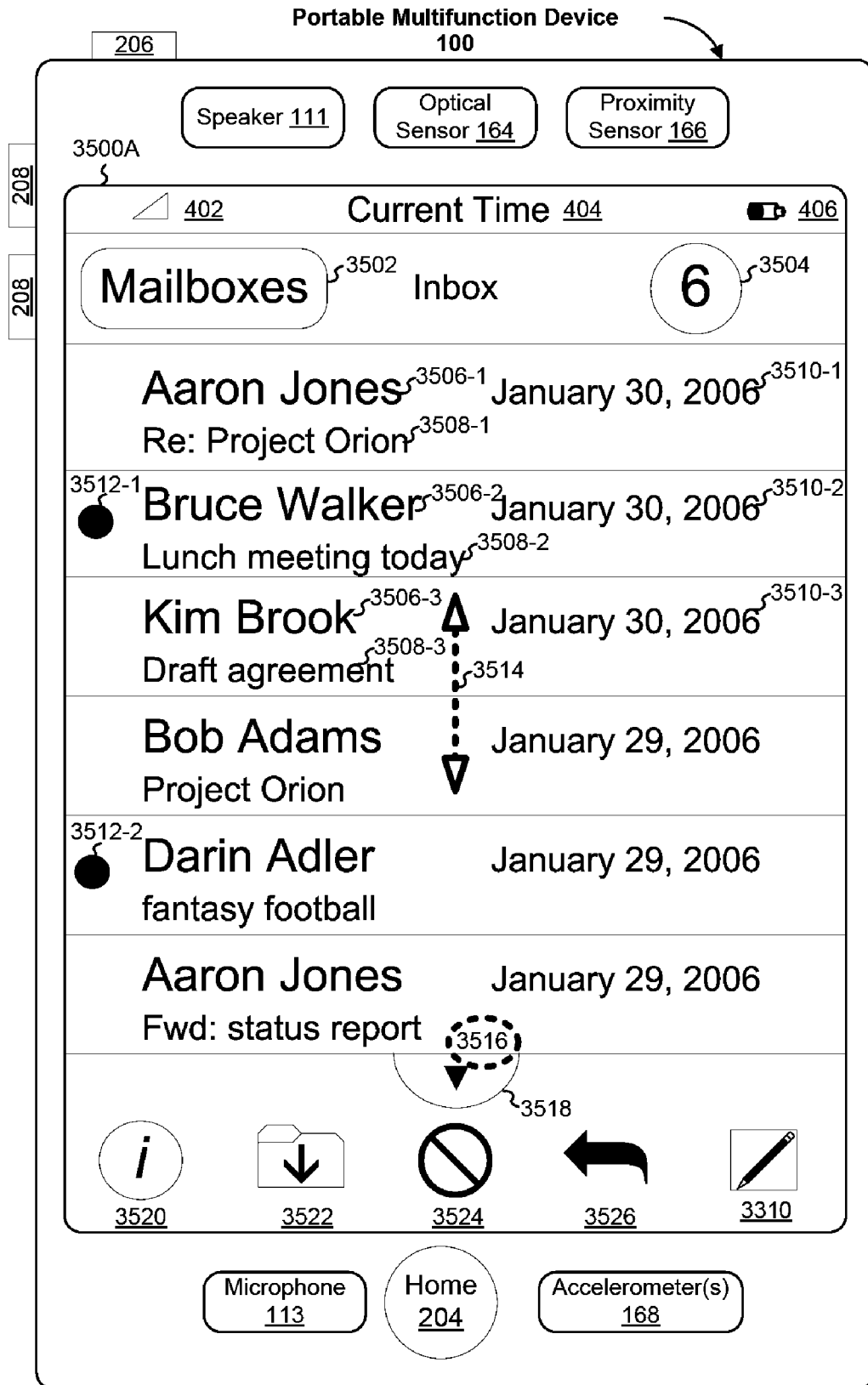

Figure 35A

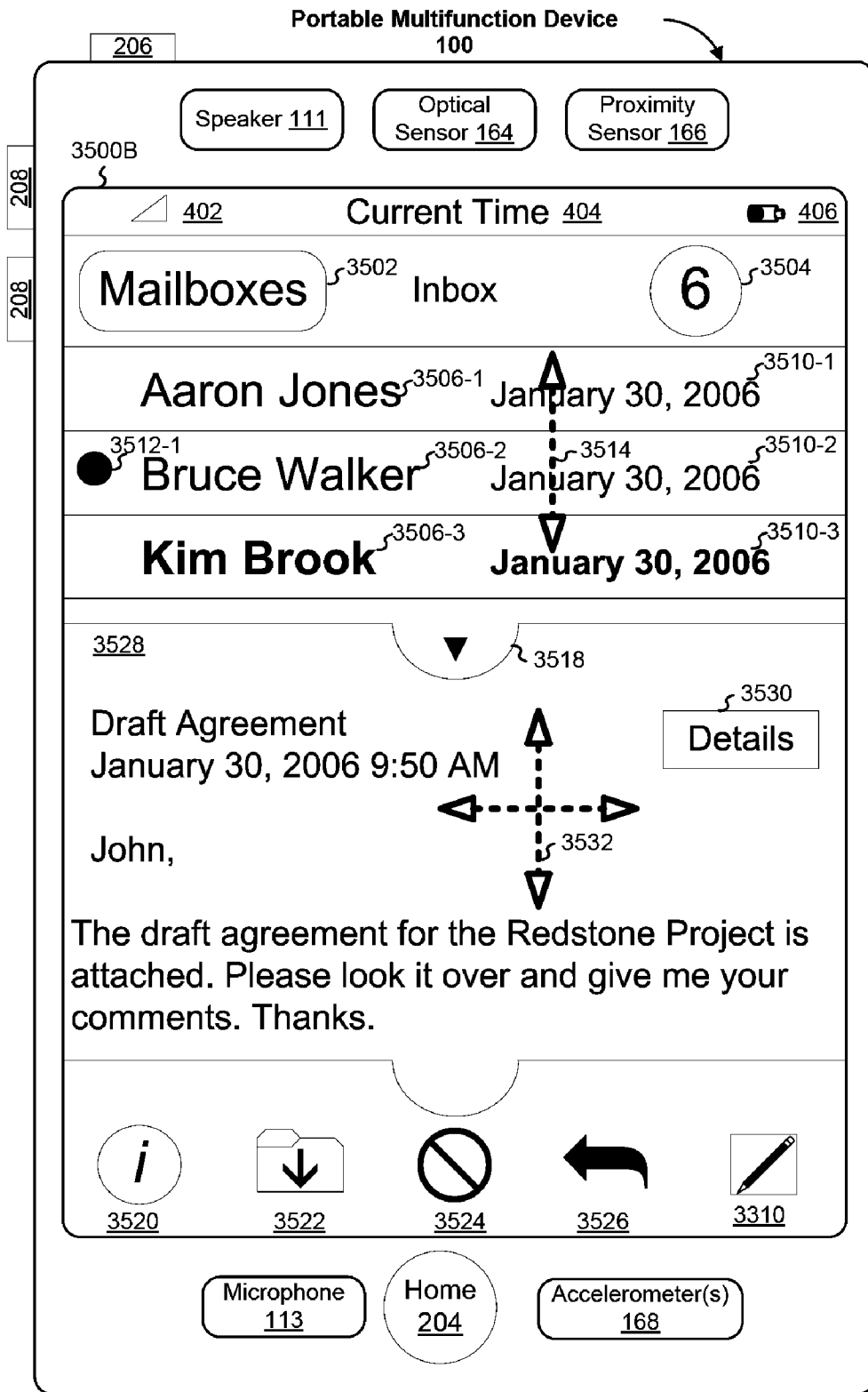

Figure 35B

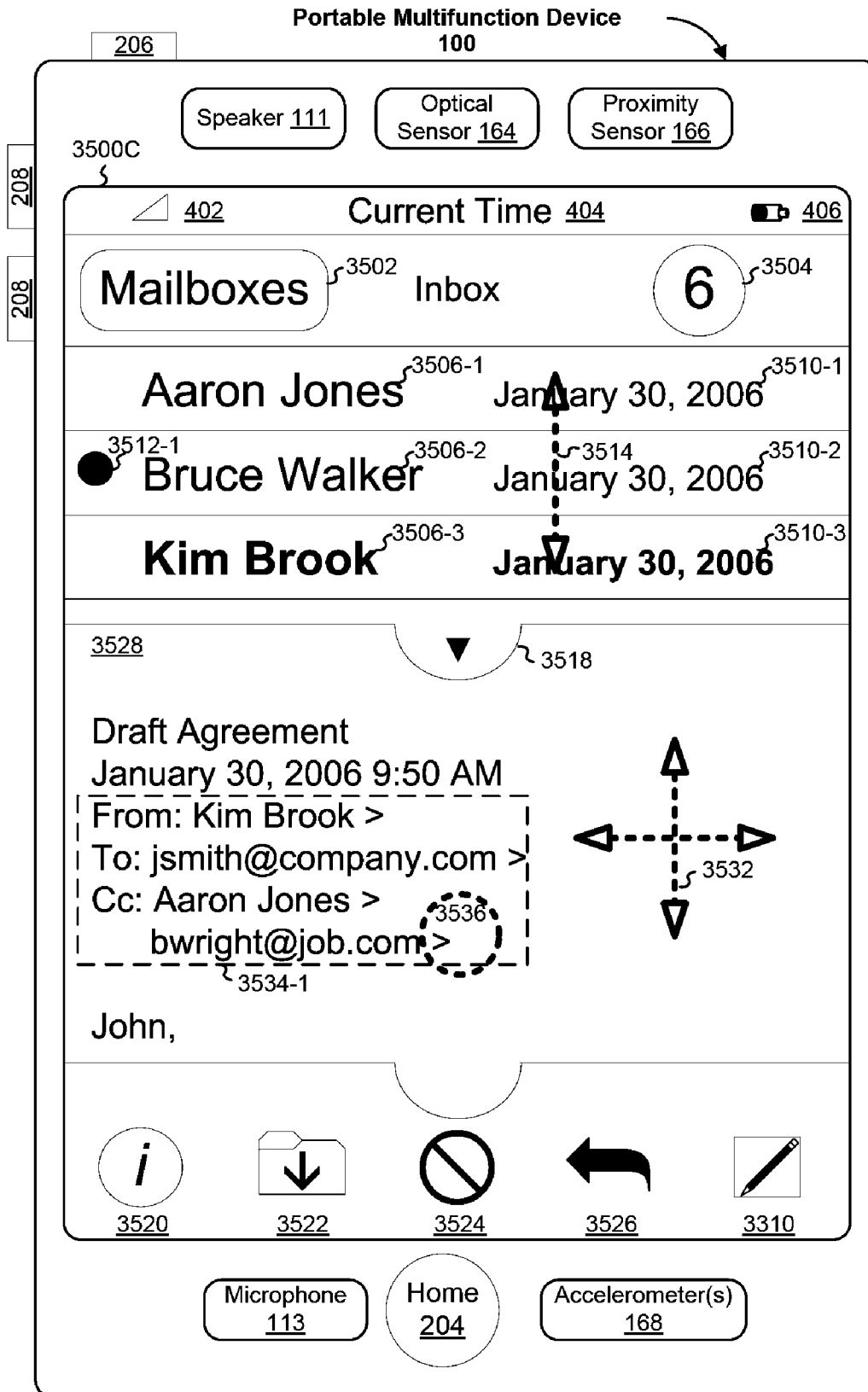

Figure 35C

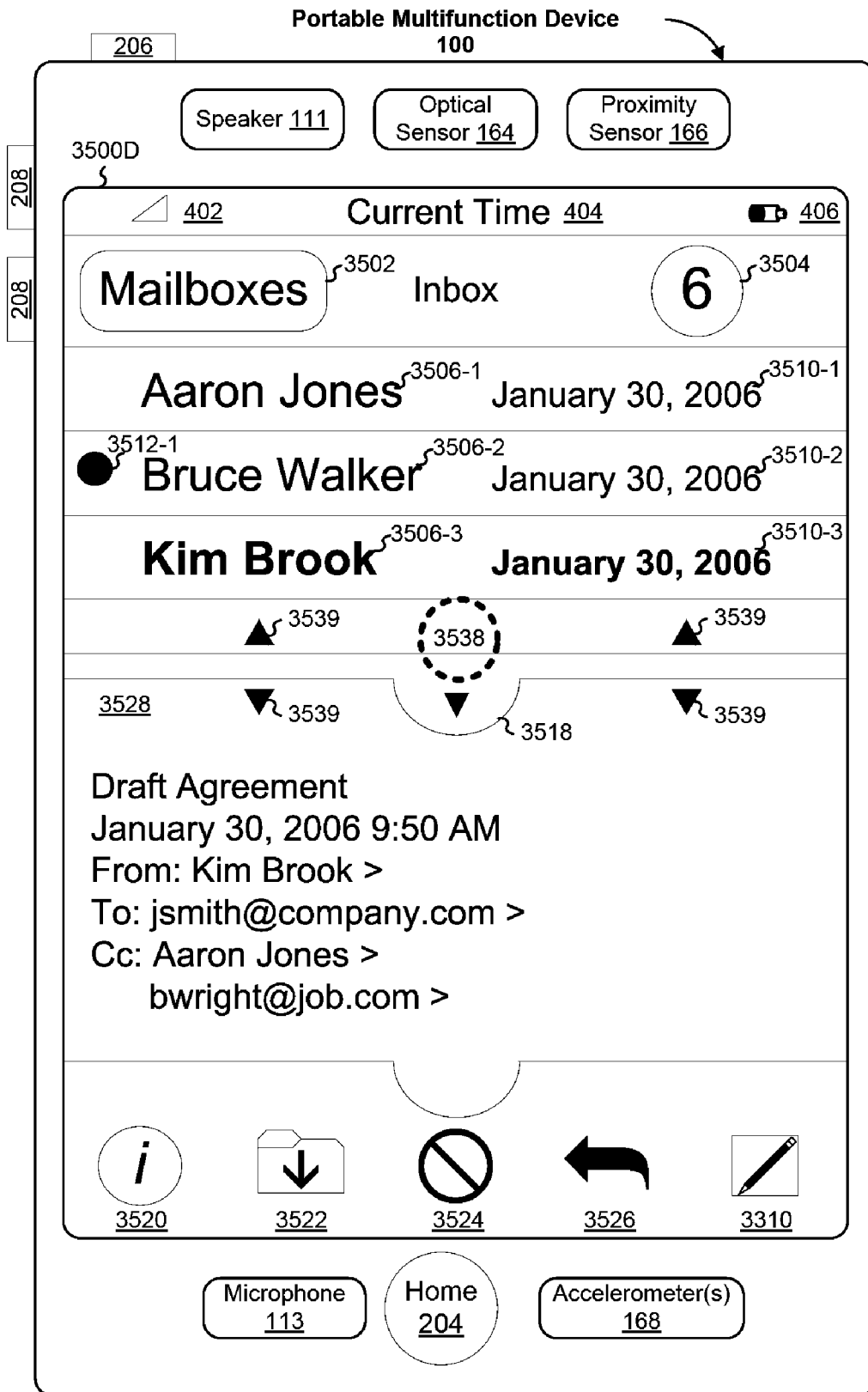

Figure 35D

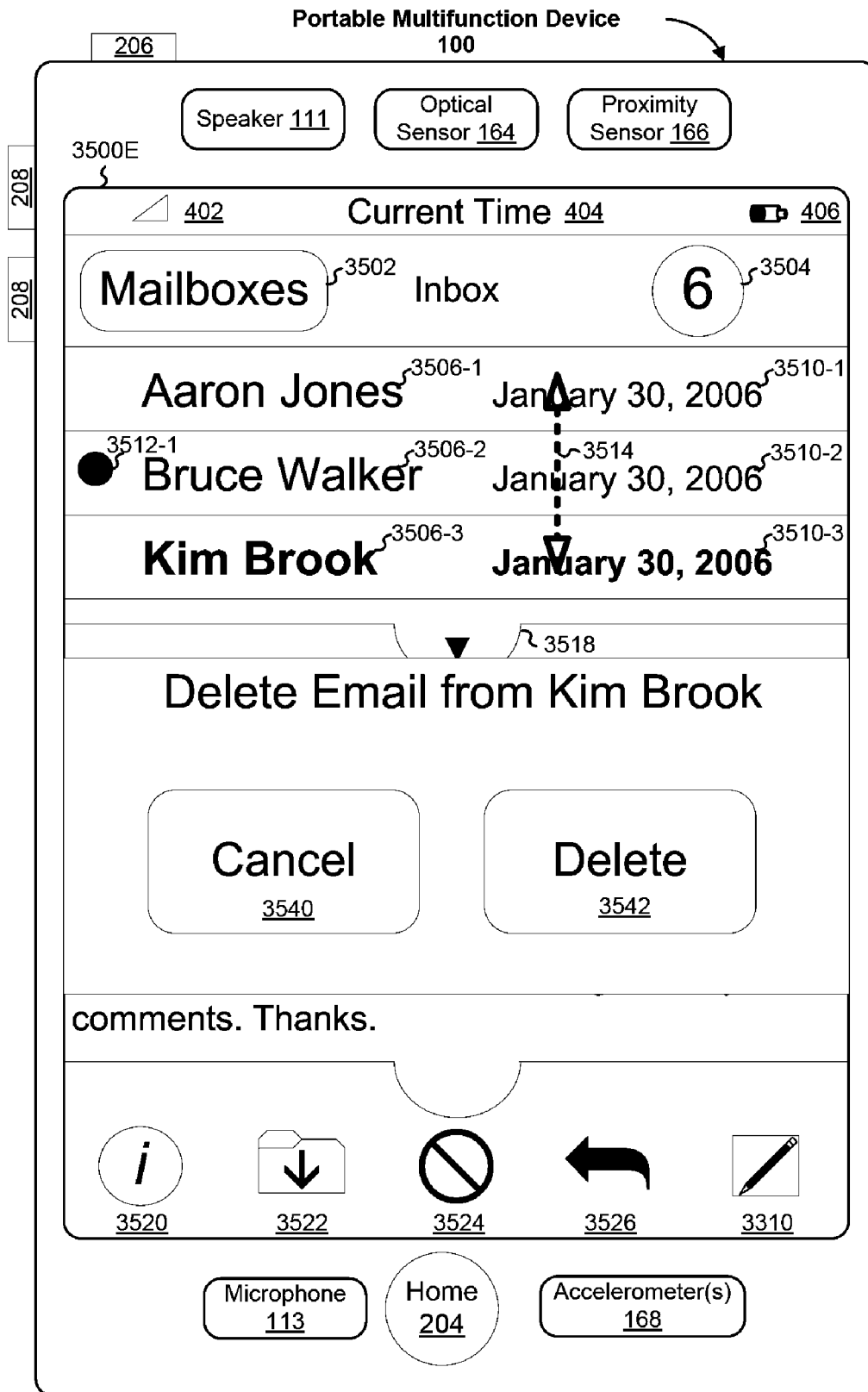

Figure 35E

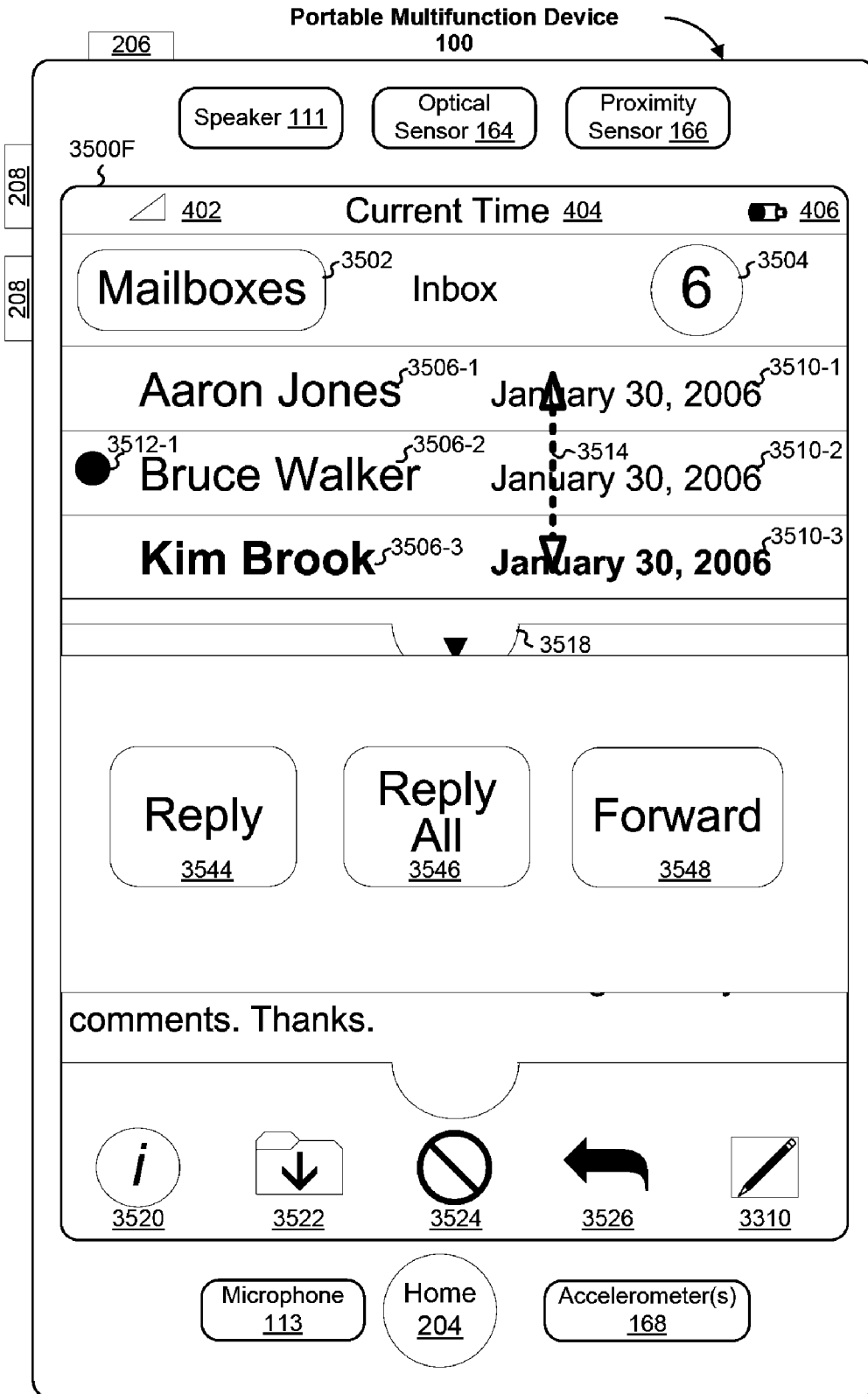

Figure 35F



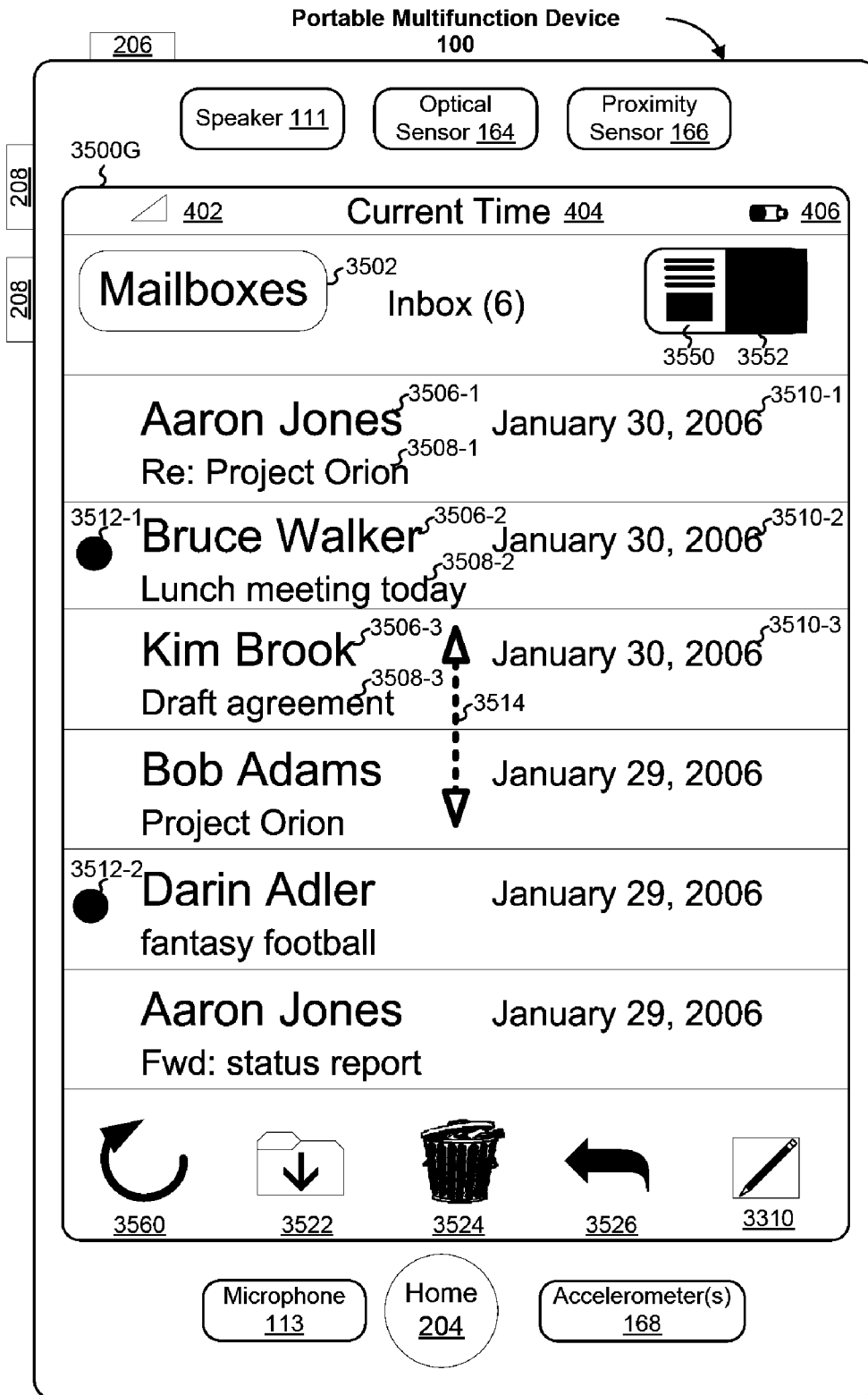

Figure 35G

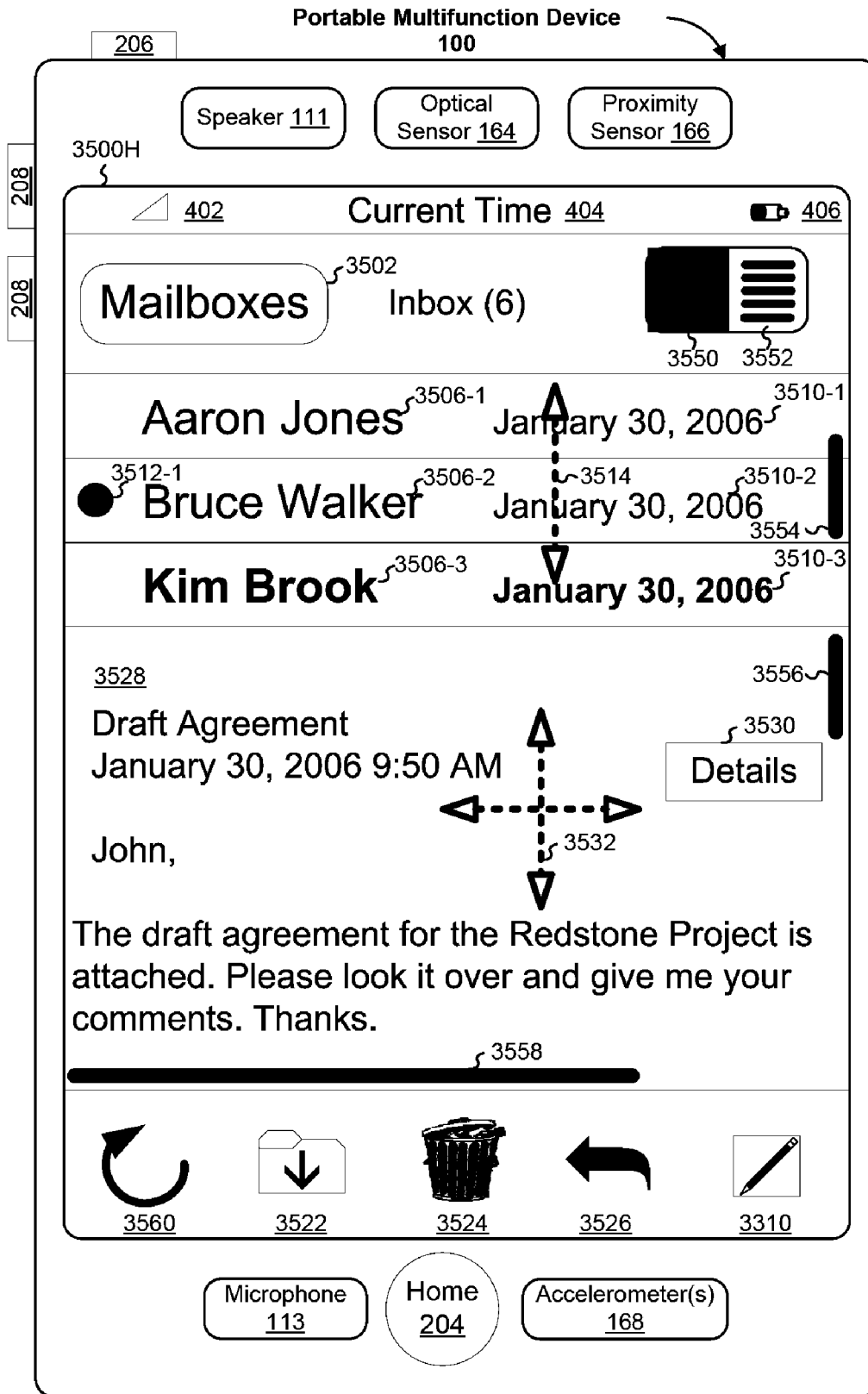

Figure 35H

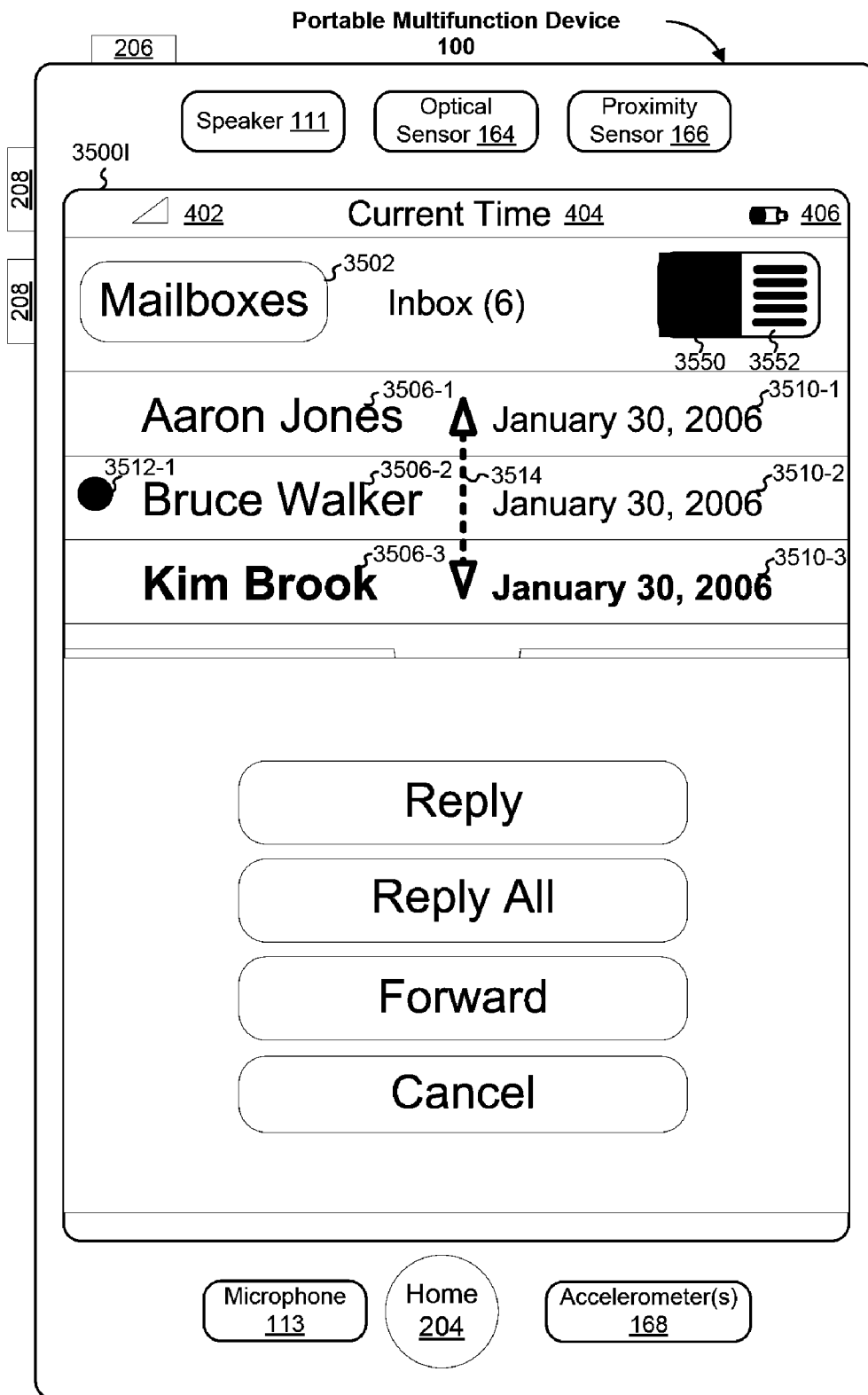

Figure 35I



Figure 35J



Figure 35K

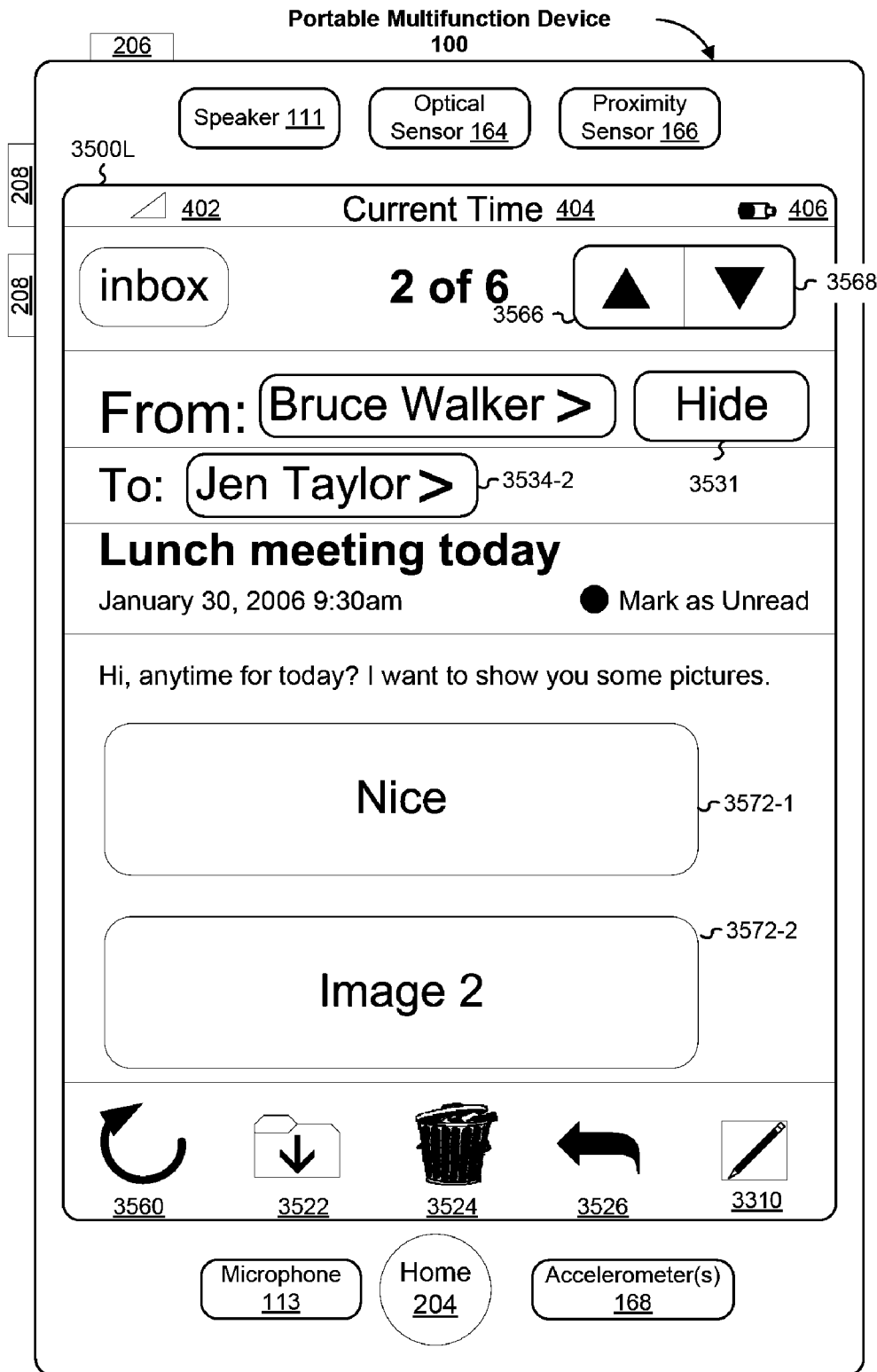

Figure 35L

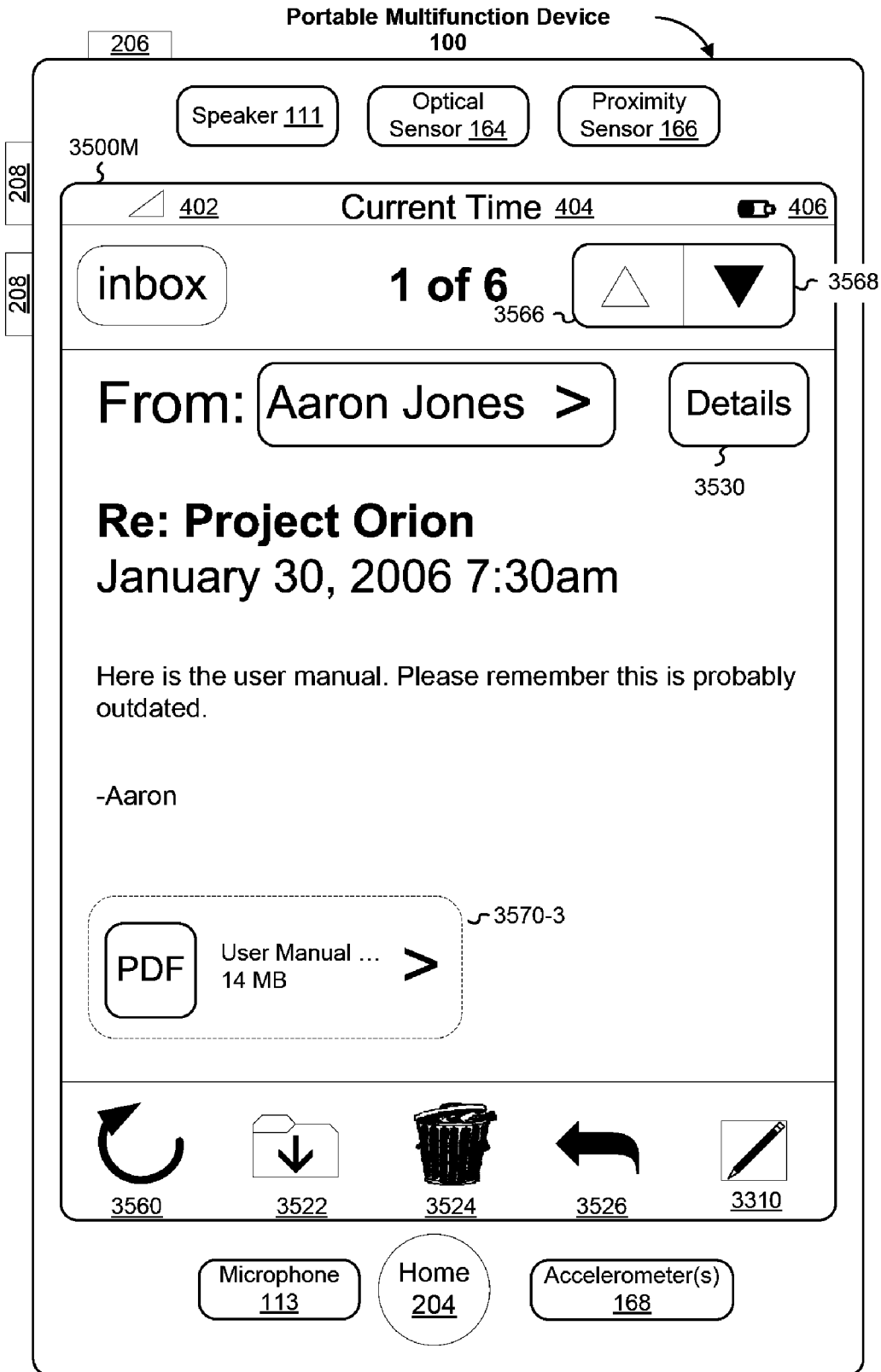

Figure 35M

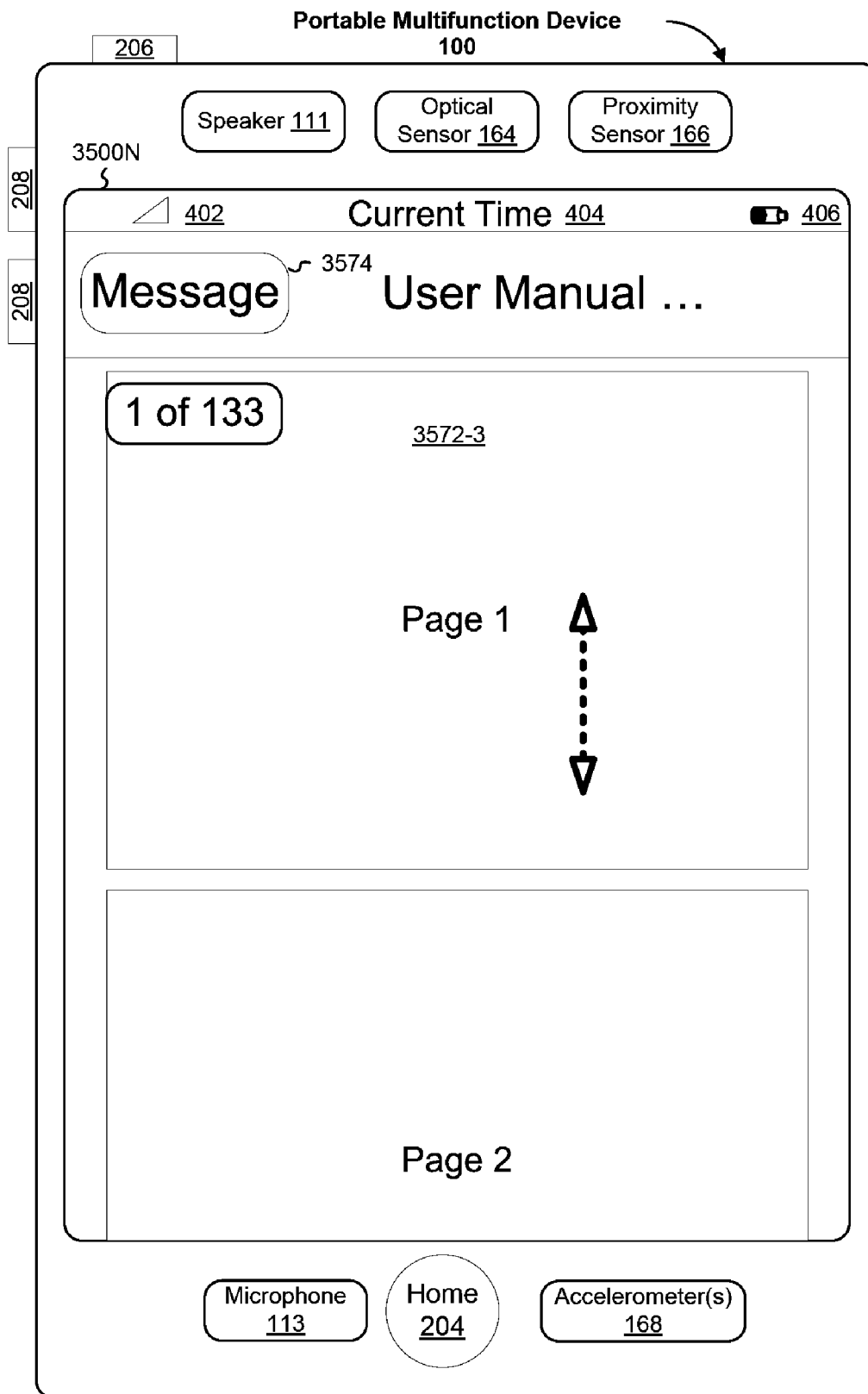

Figure 35N





Figure 350

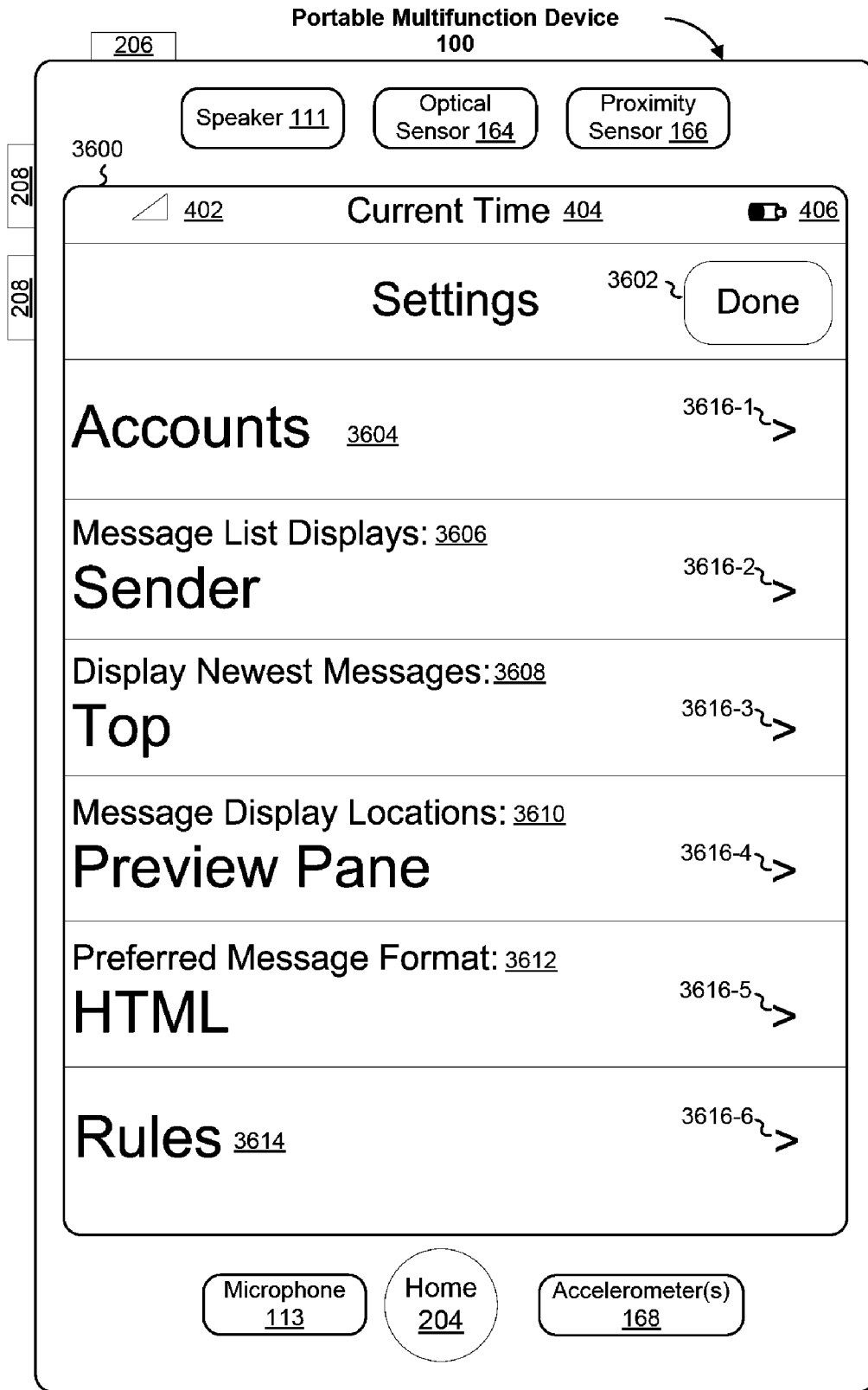

Figure 36

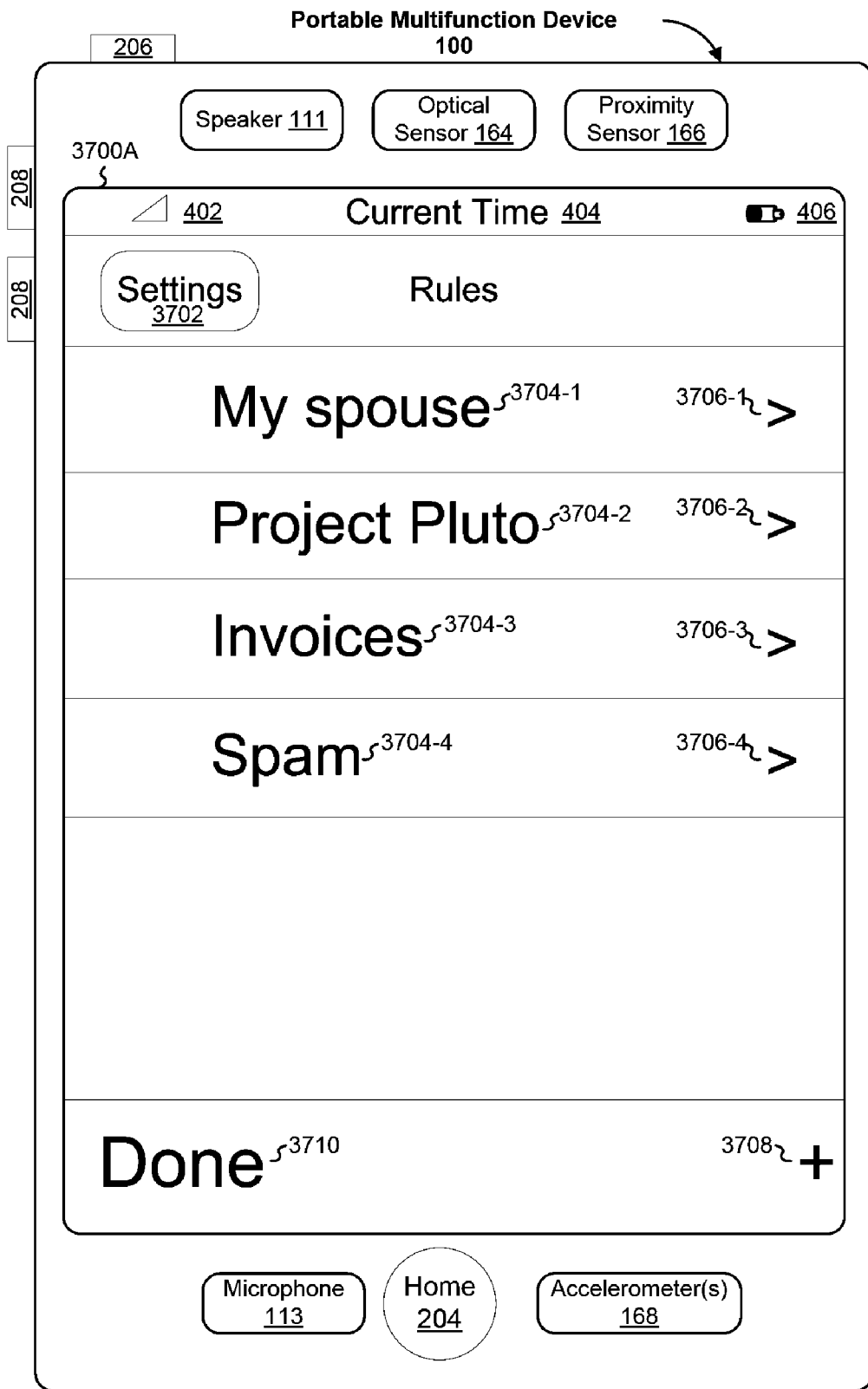

Figure 37A

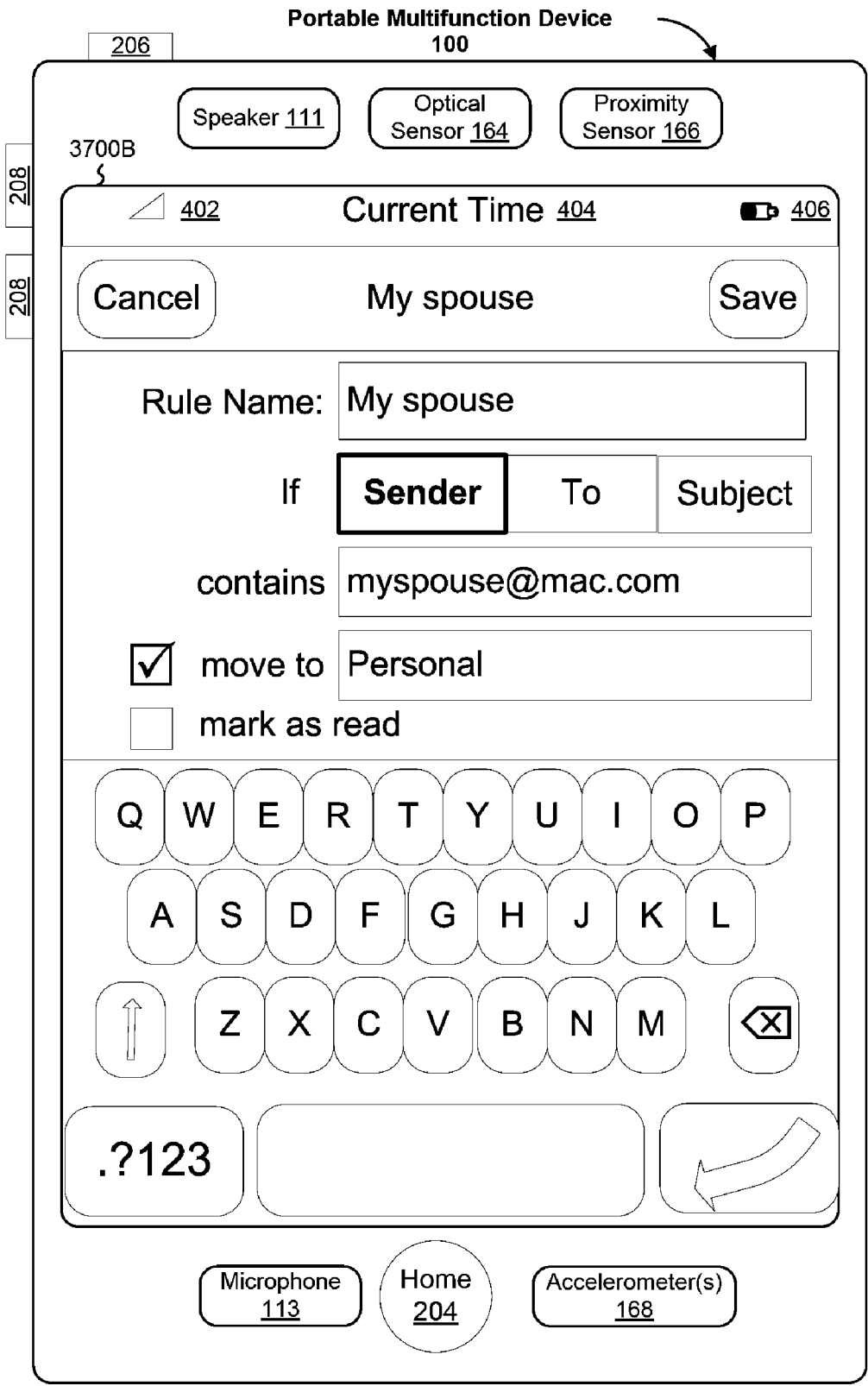

Figure 37B

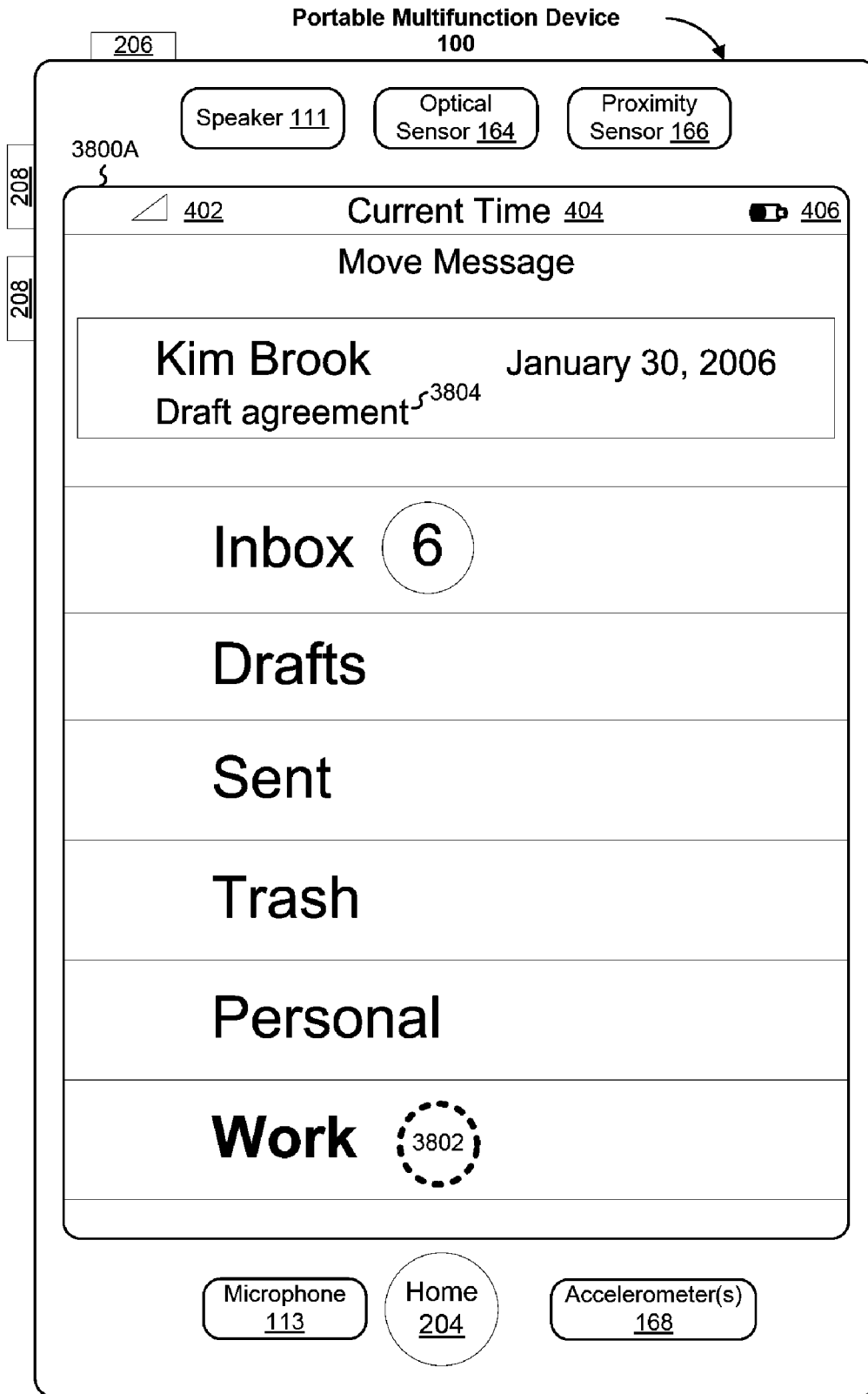

Figure 38A

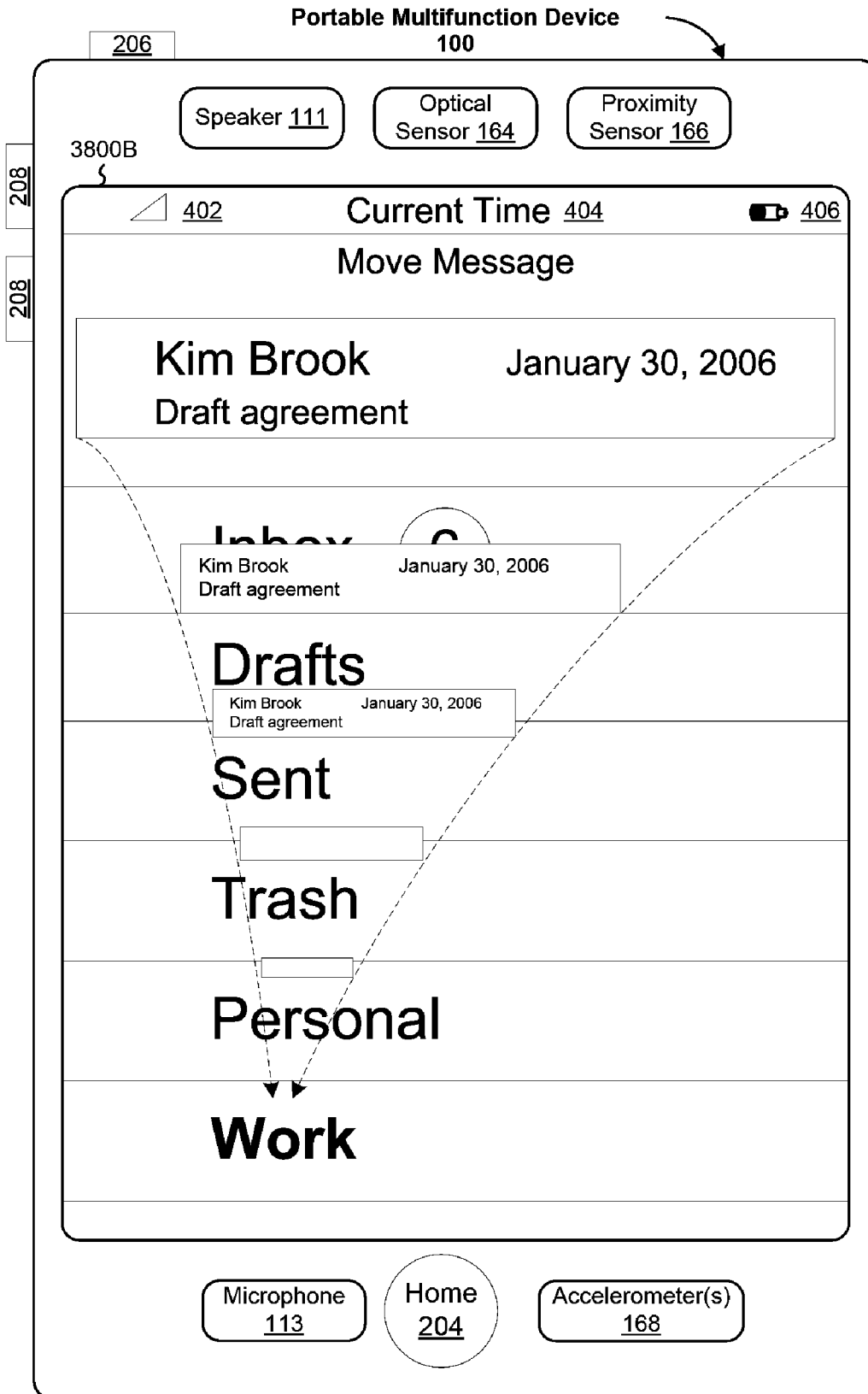

Figure 38B

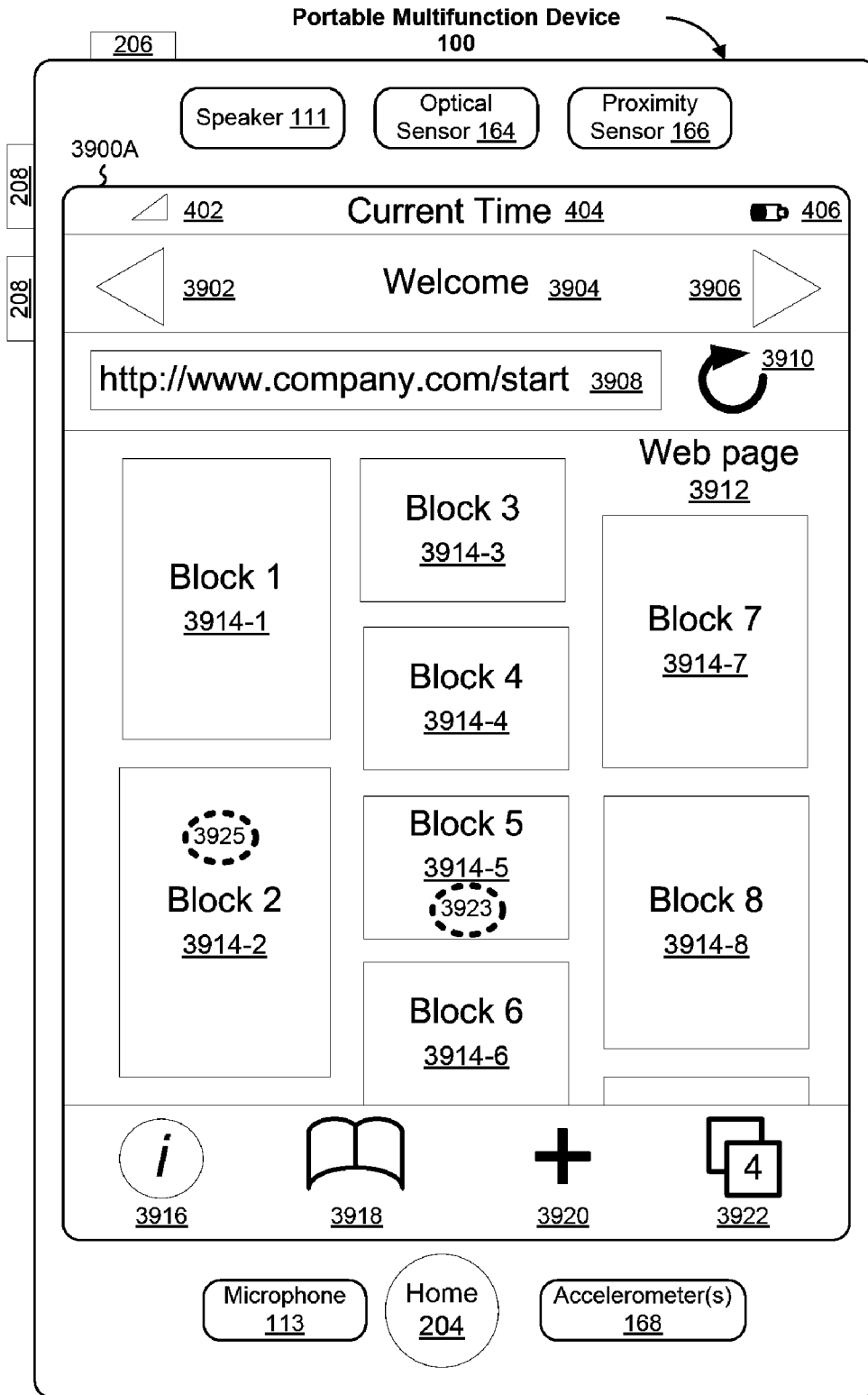

Figure 39A



Figure 39B



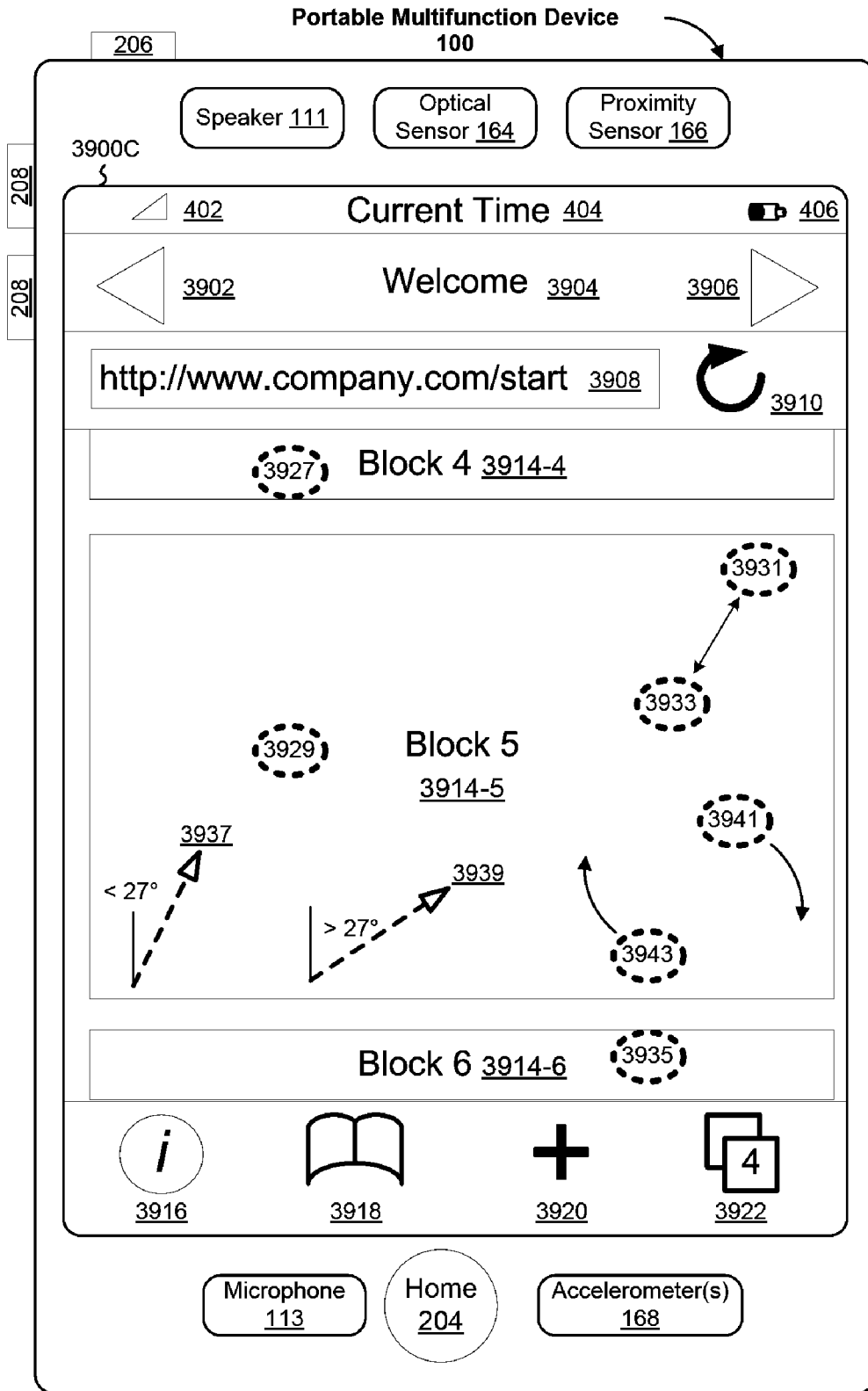

Figure 39C

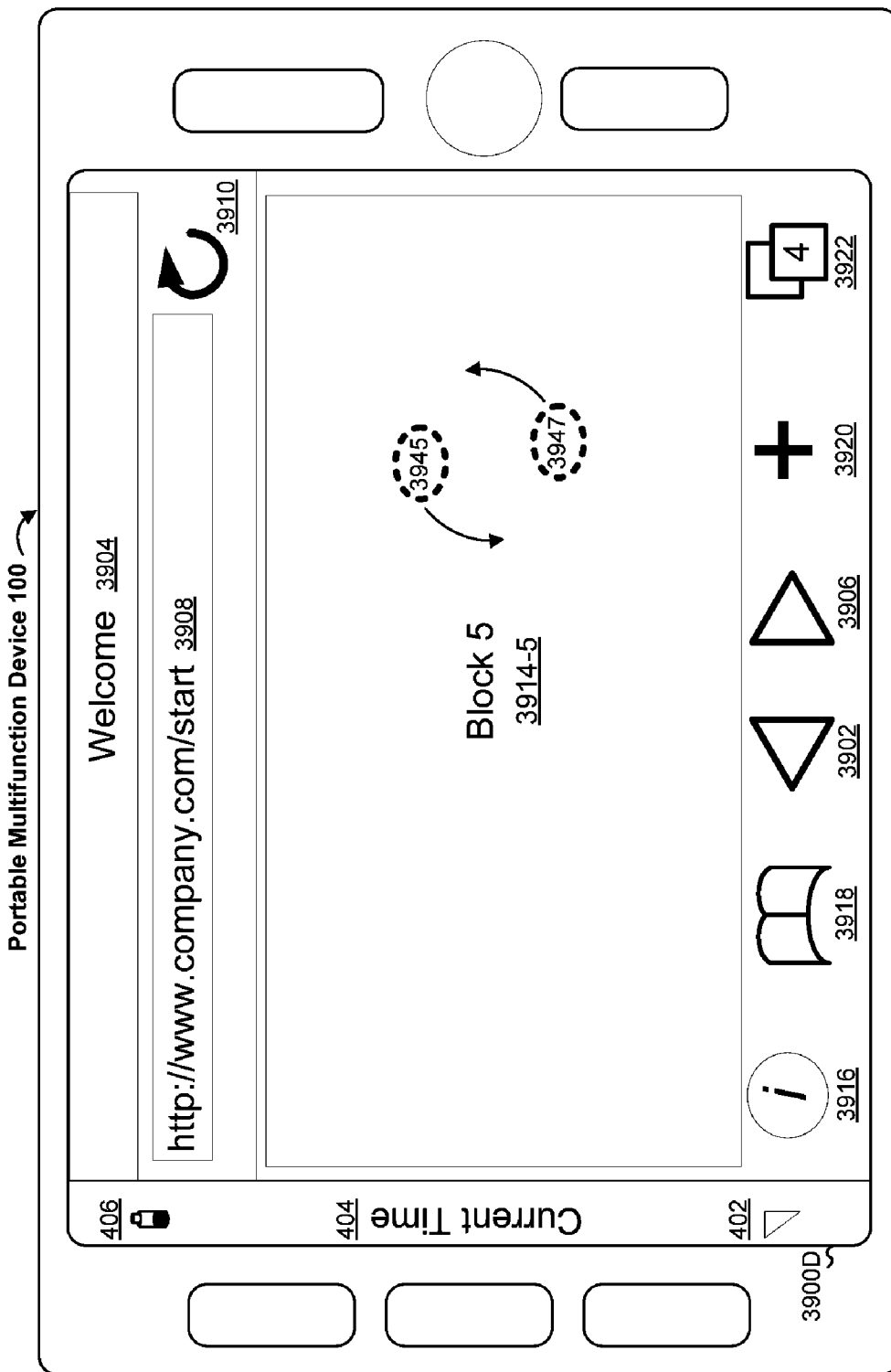

Figure 39D

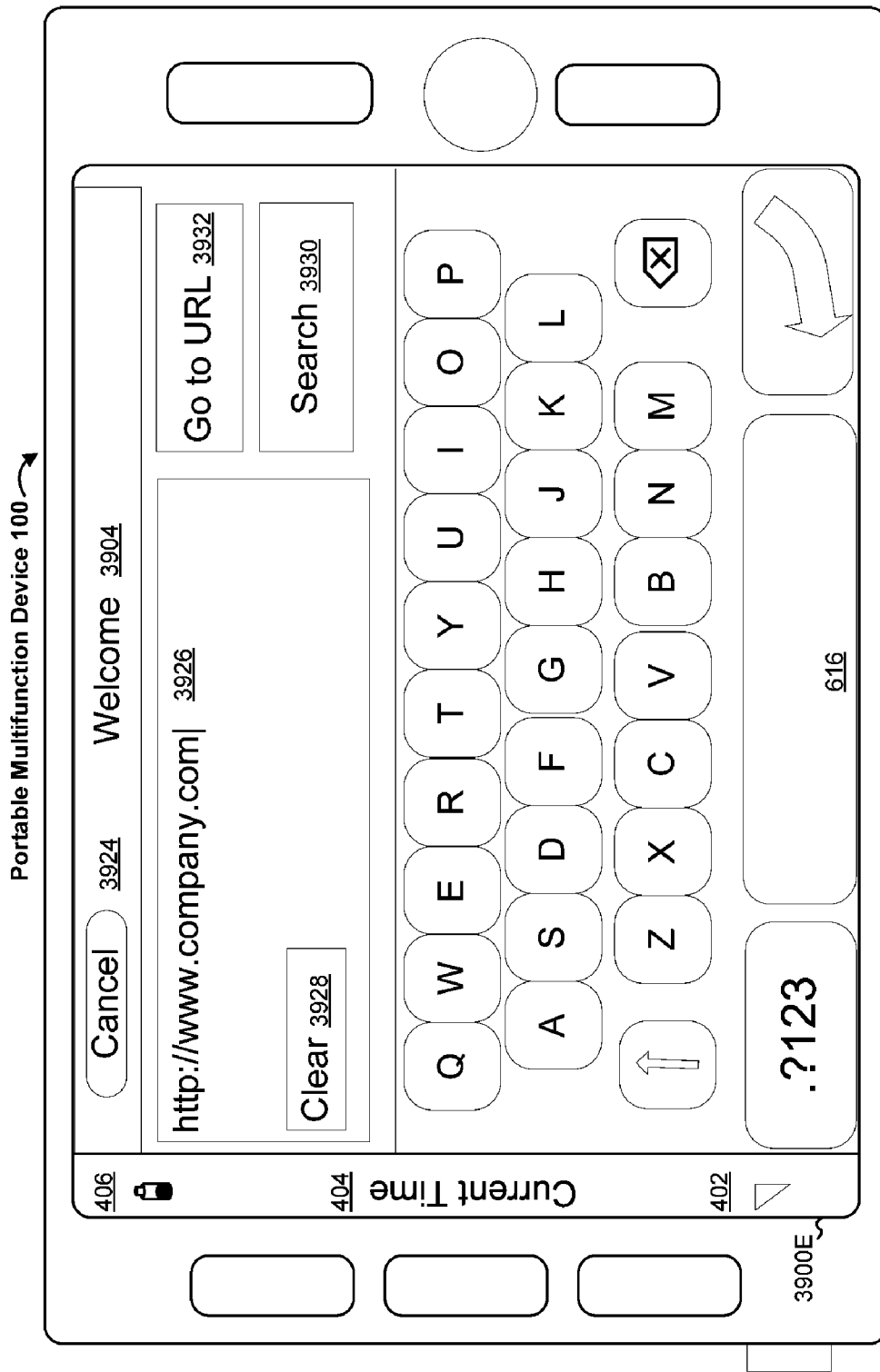

Figure 39E

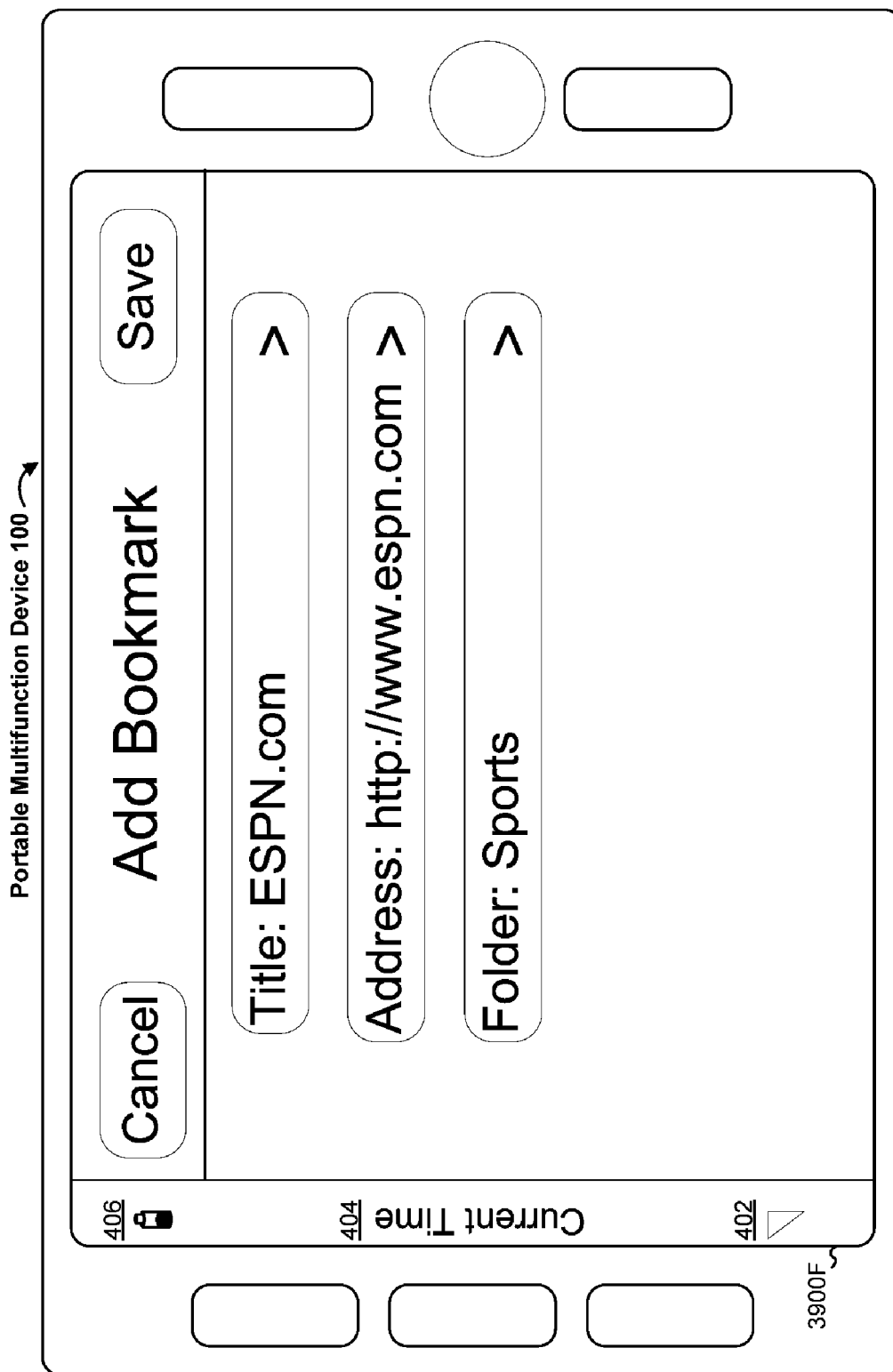

Figure 39F

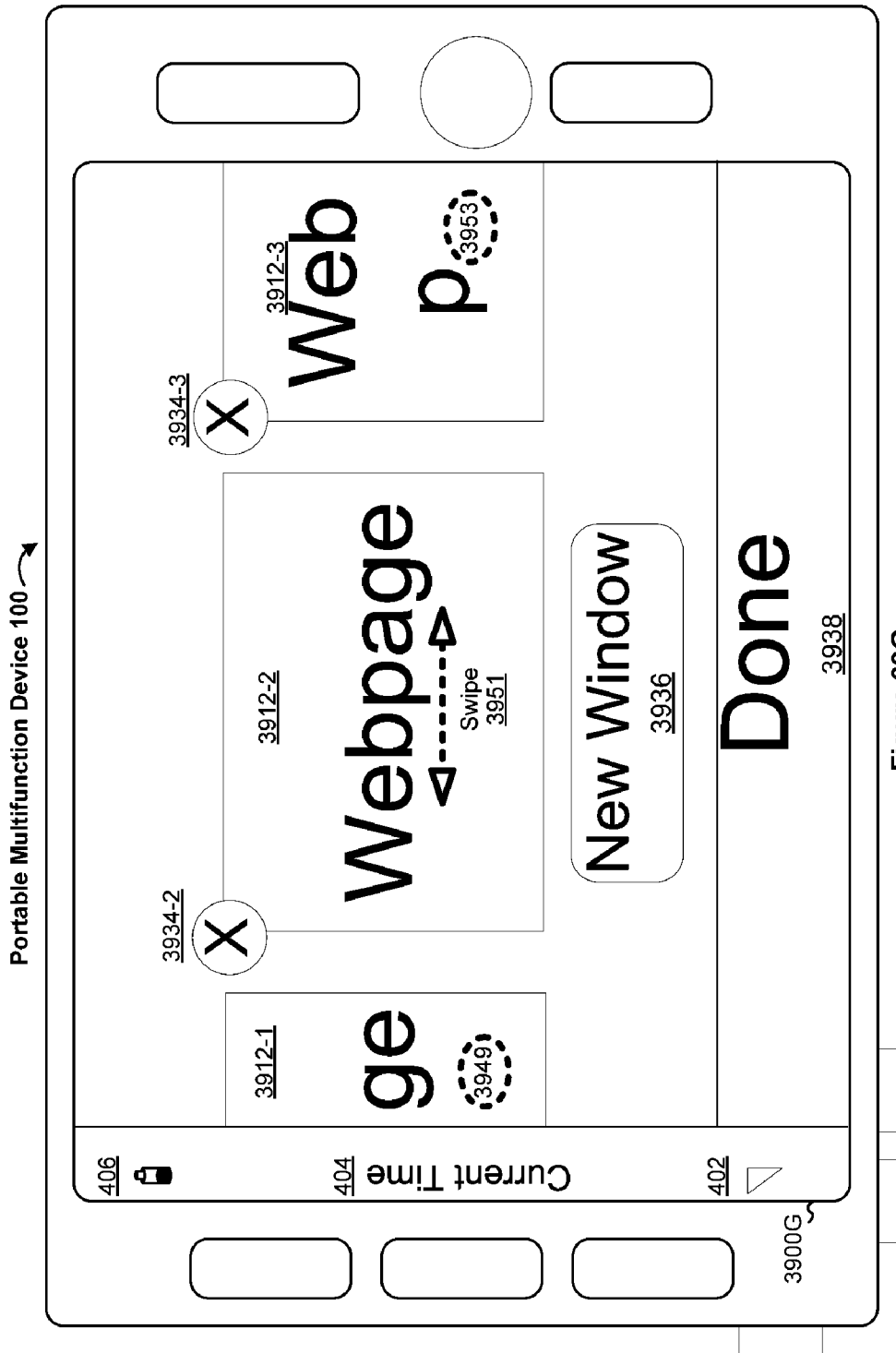

Figure 39G

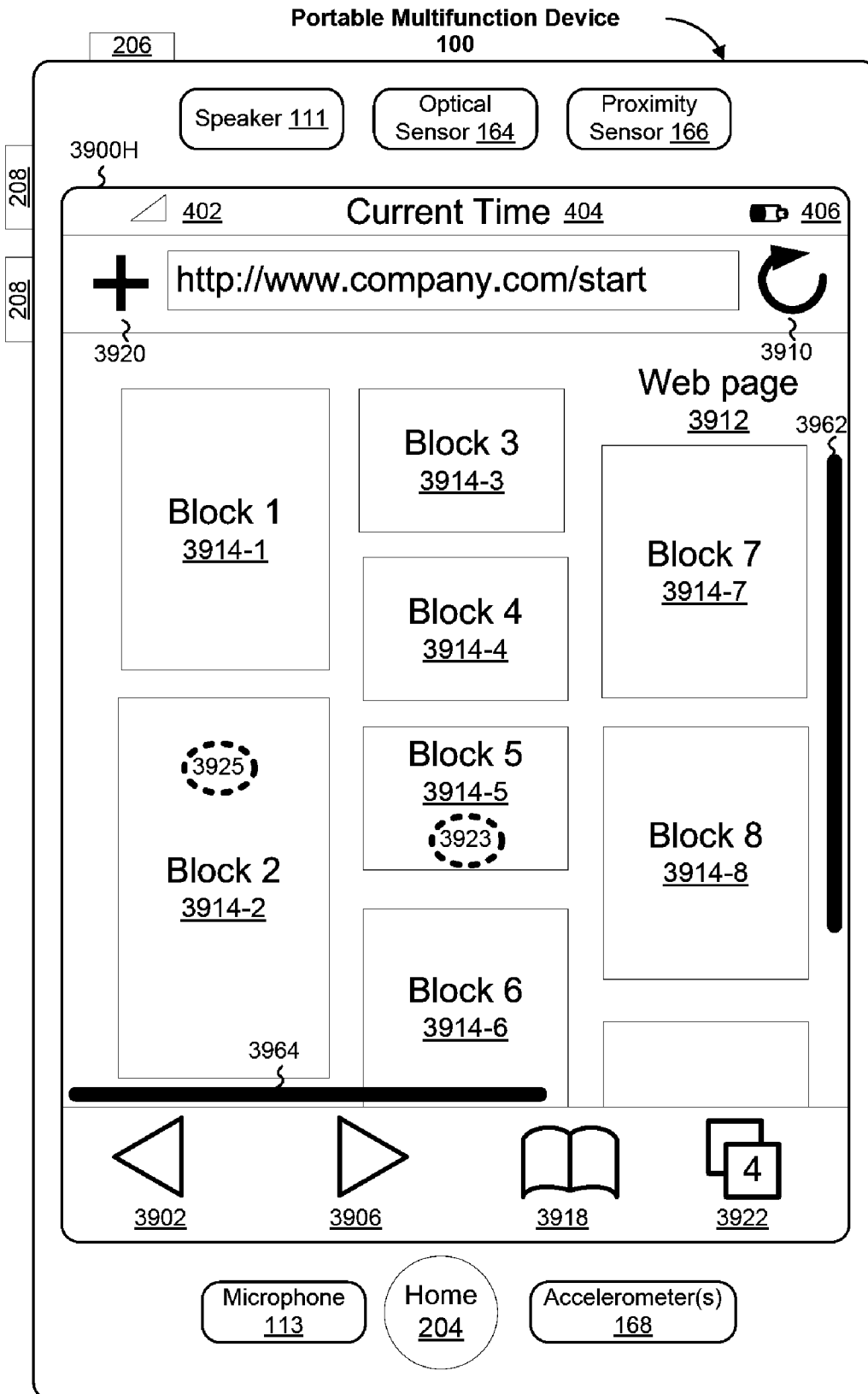

Figure 39H

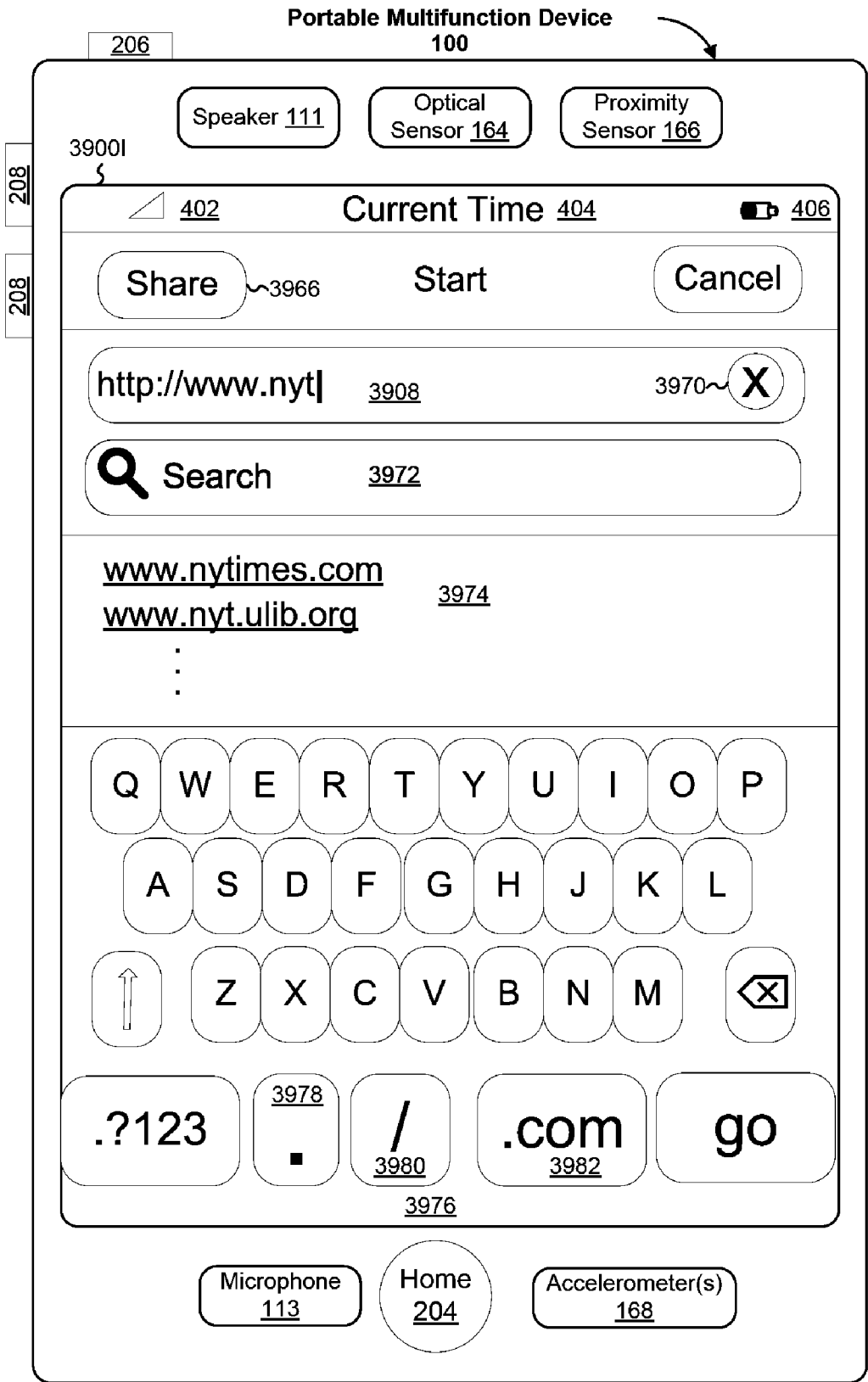

Figure 39I



Figure 39J



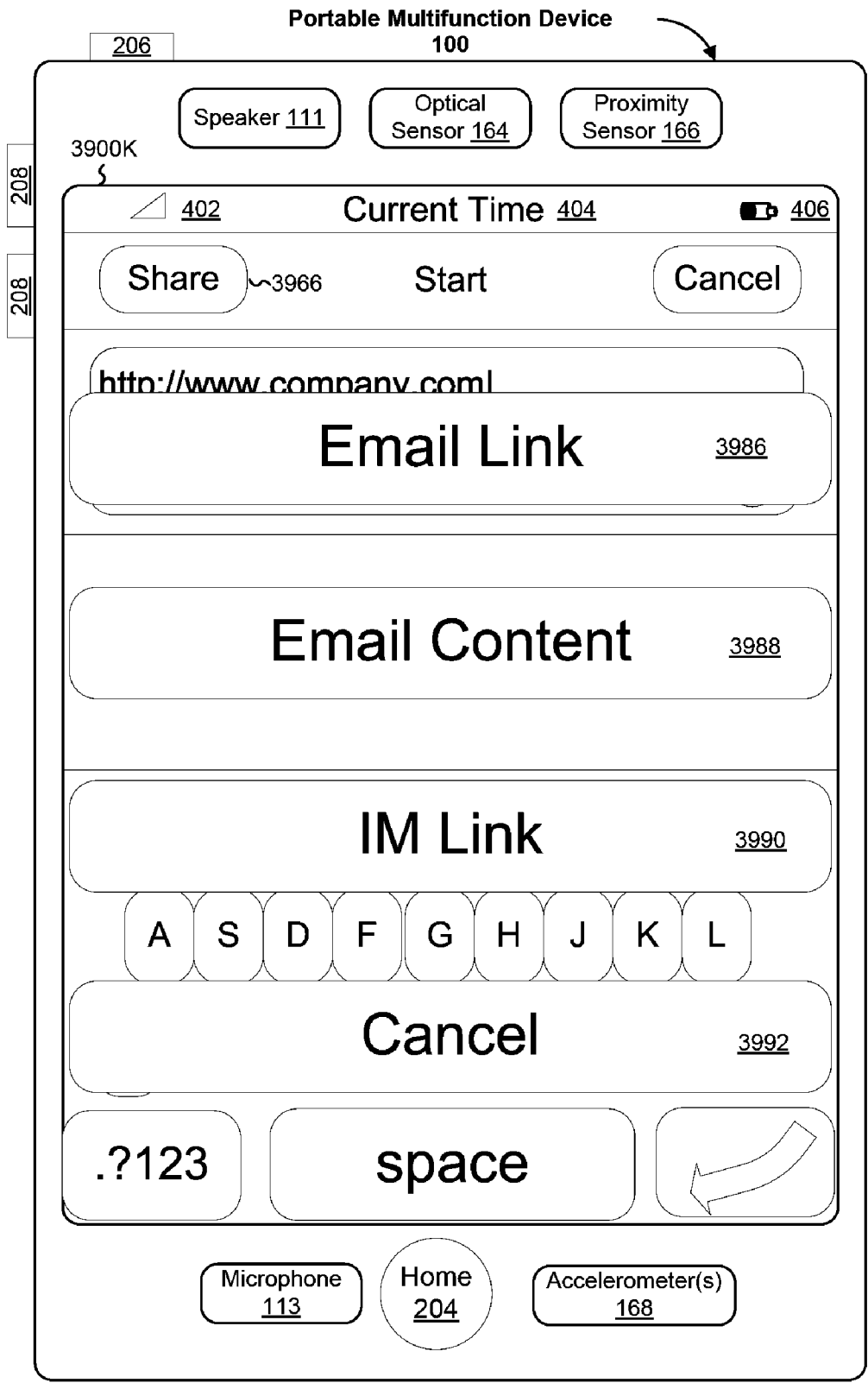

Figure 39K

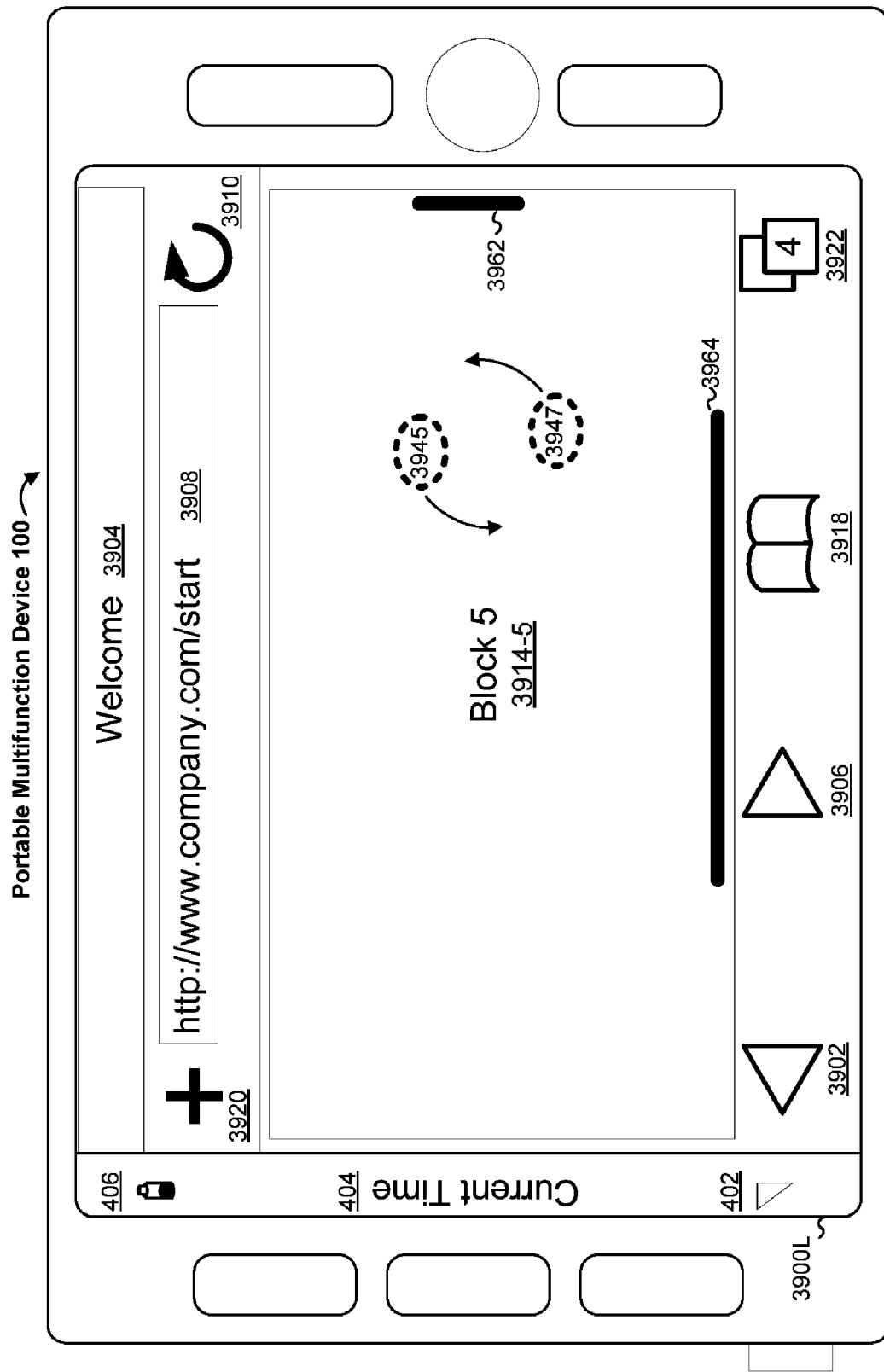

Figure 39L

Portable Multifunction Device 100

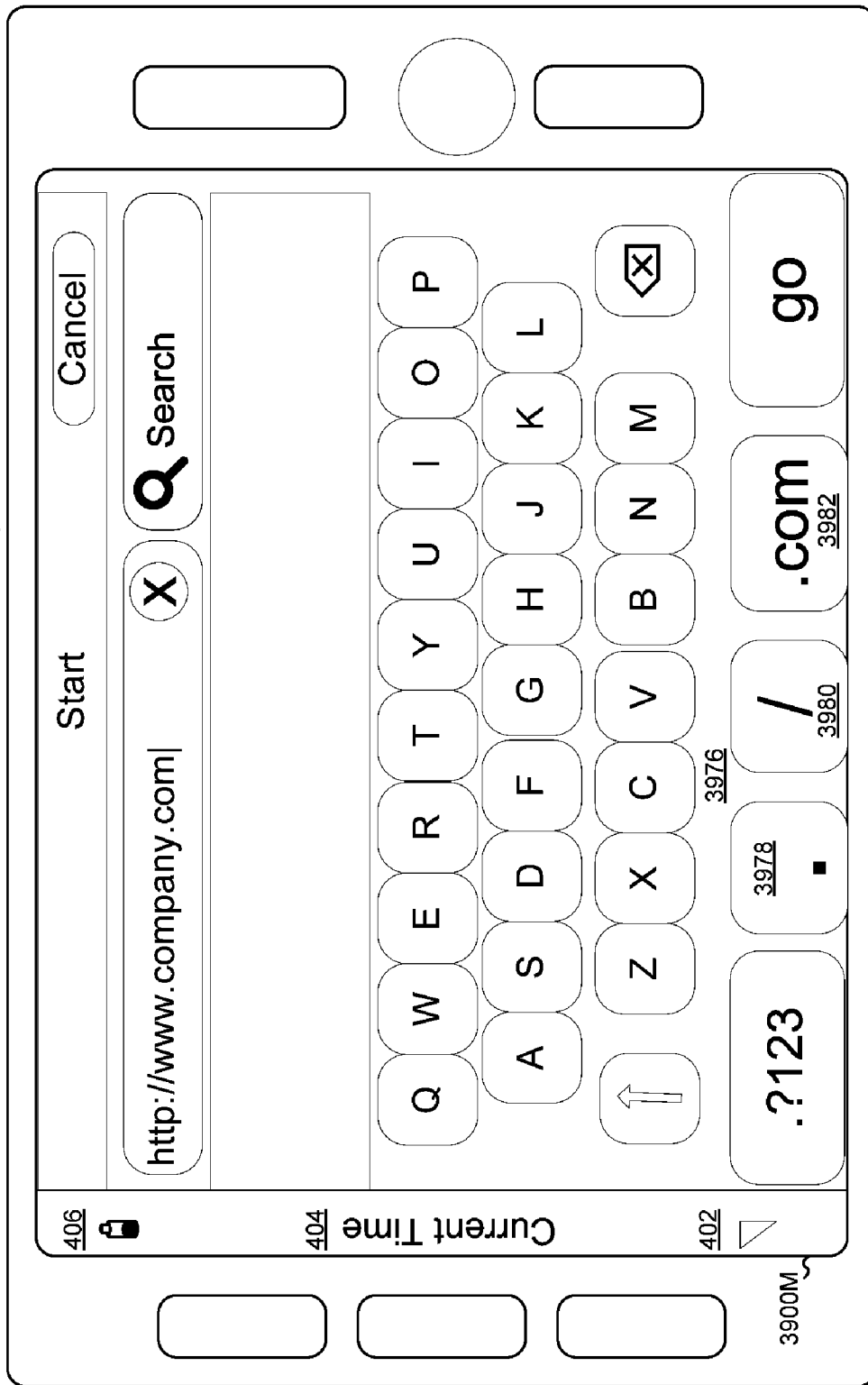

Figure 39M

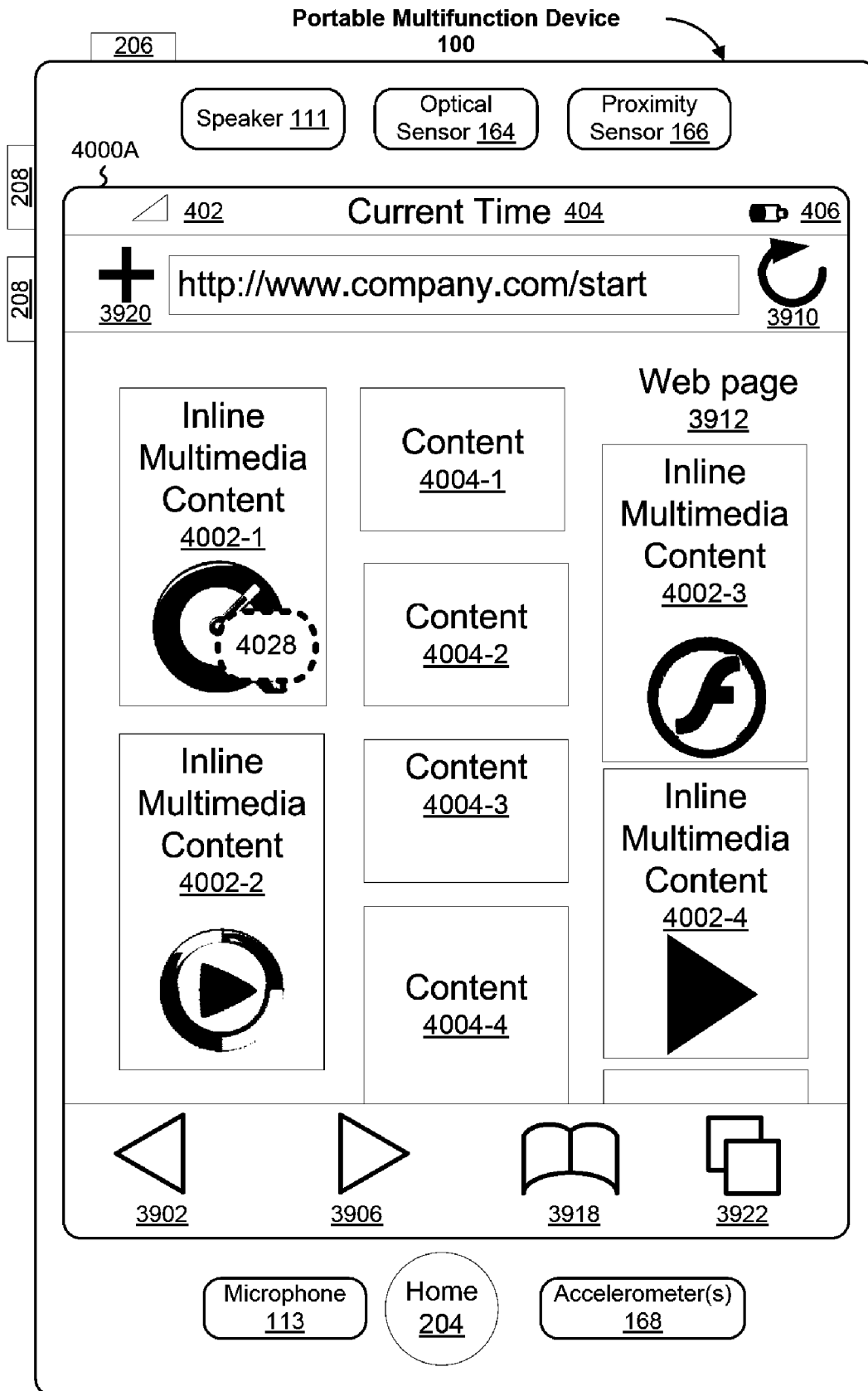
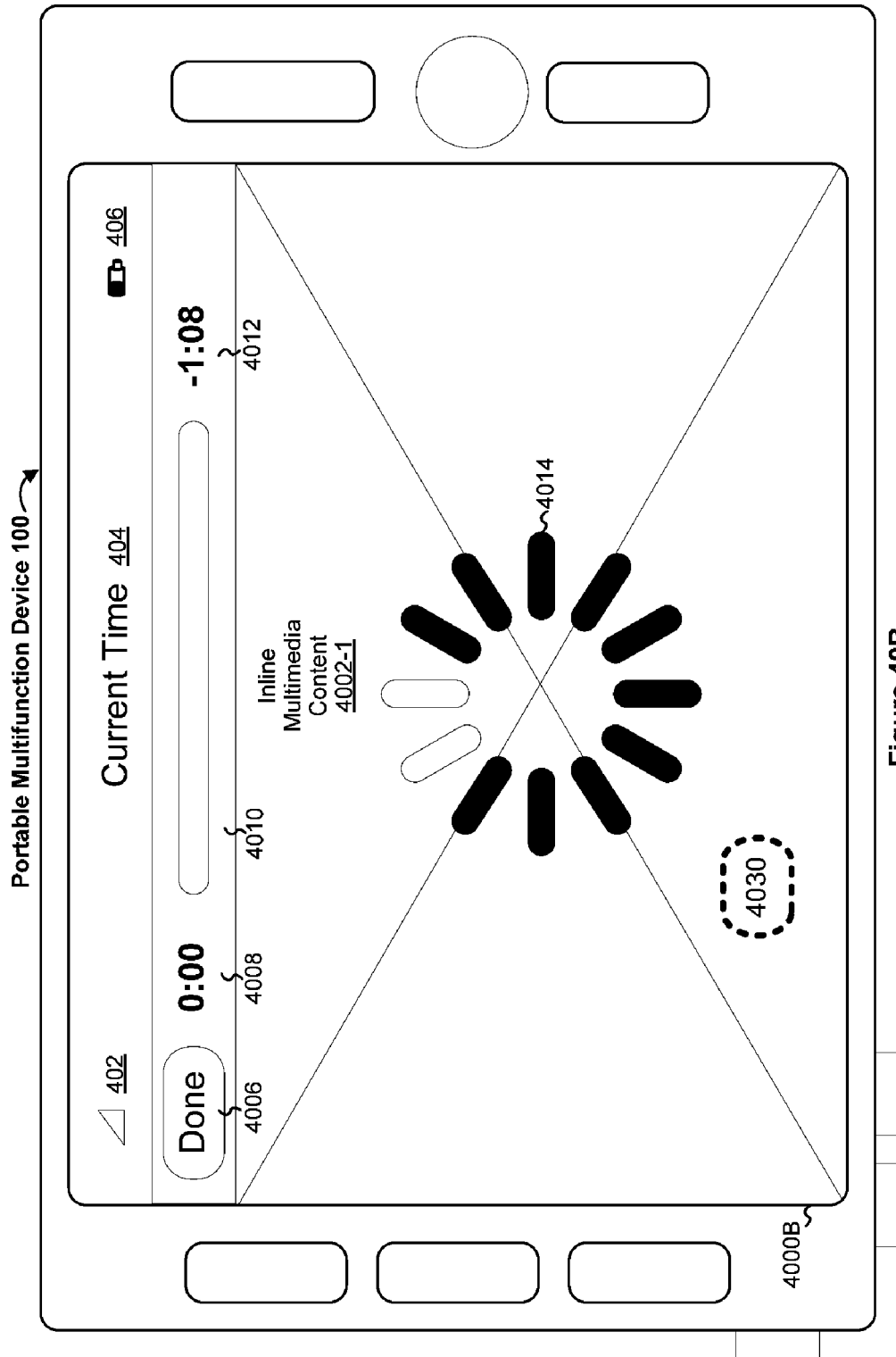

Figure 40A



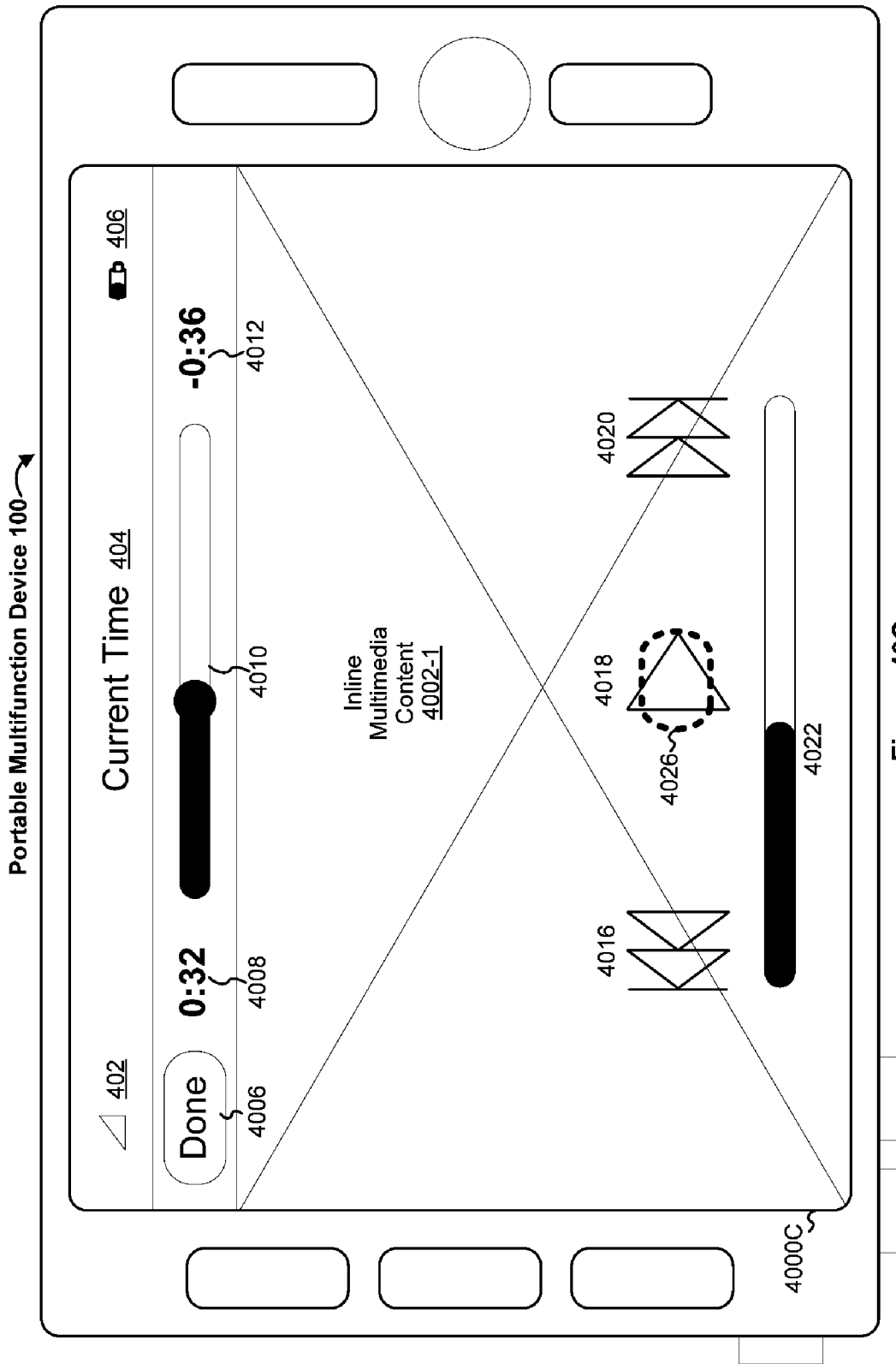
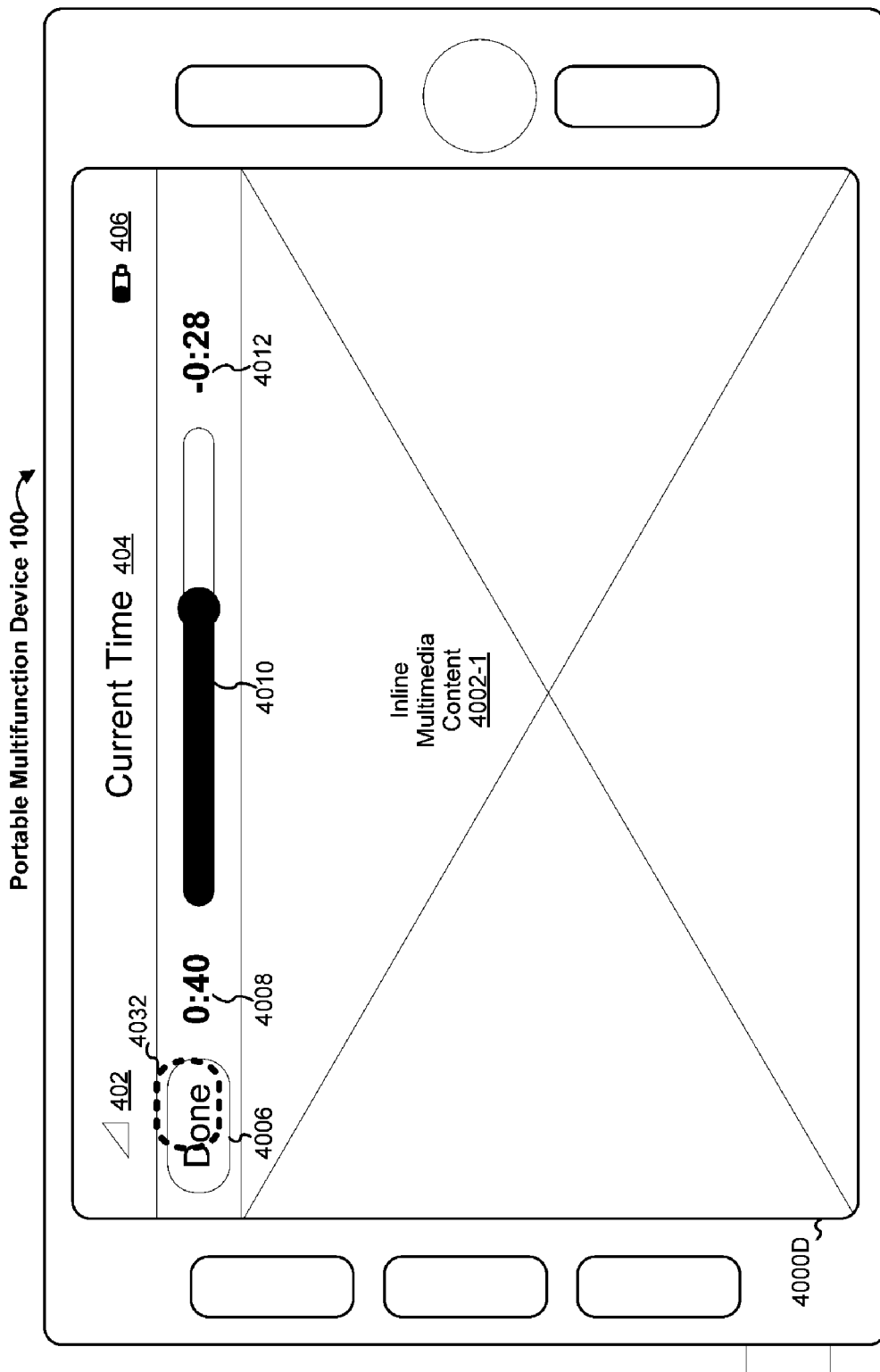

Figure 40C



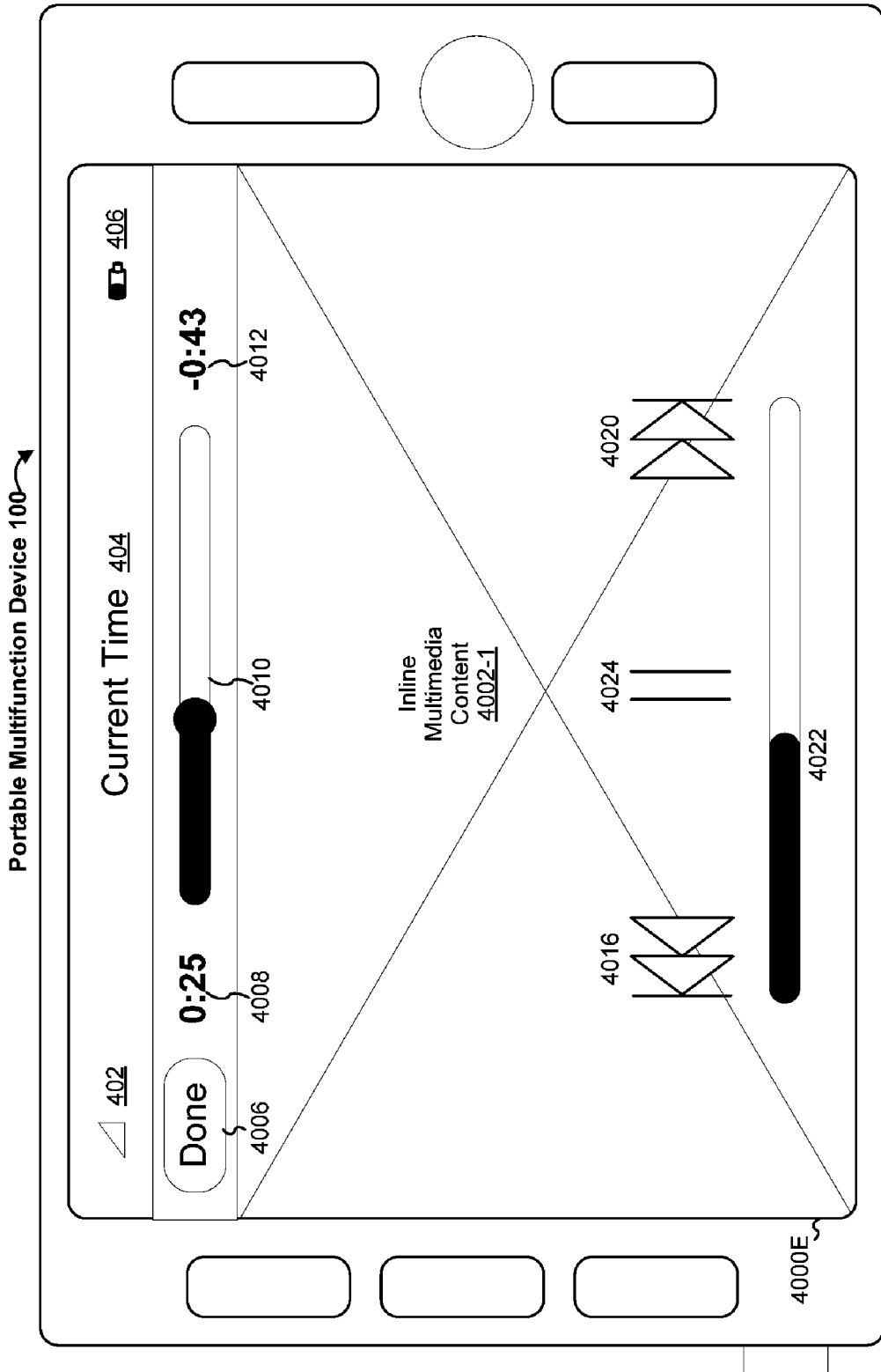

Figure 40E



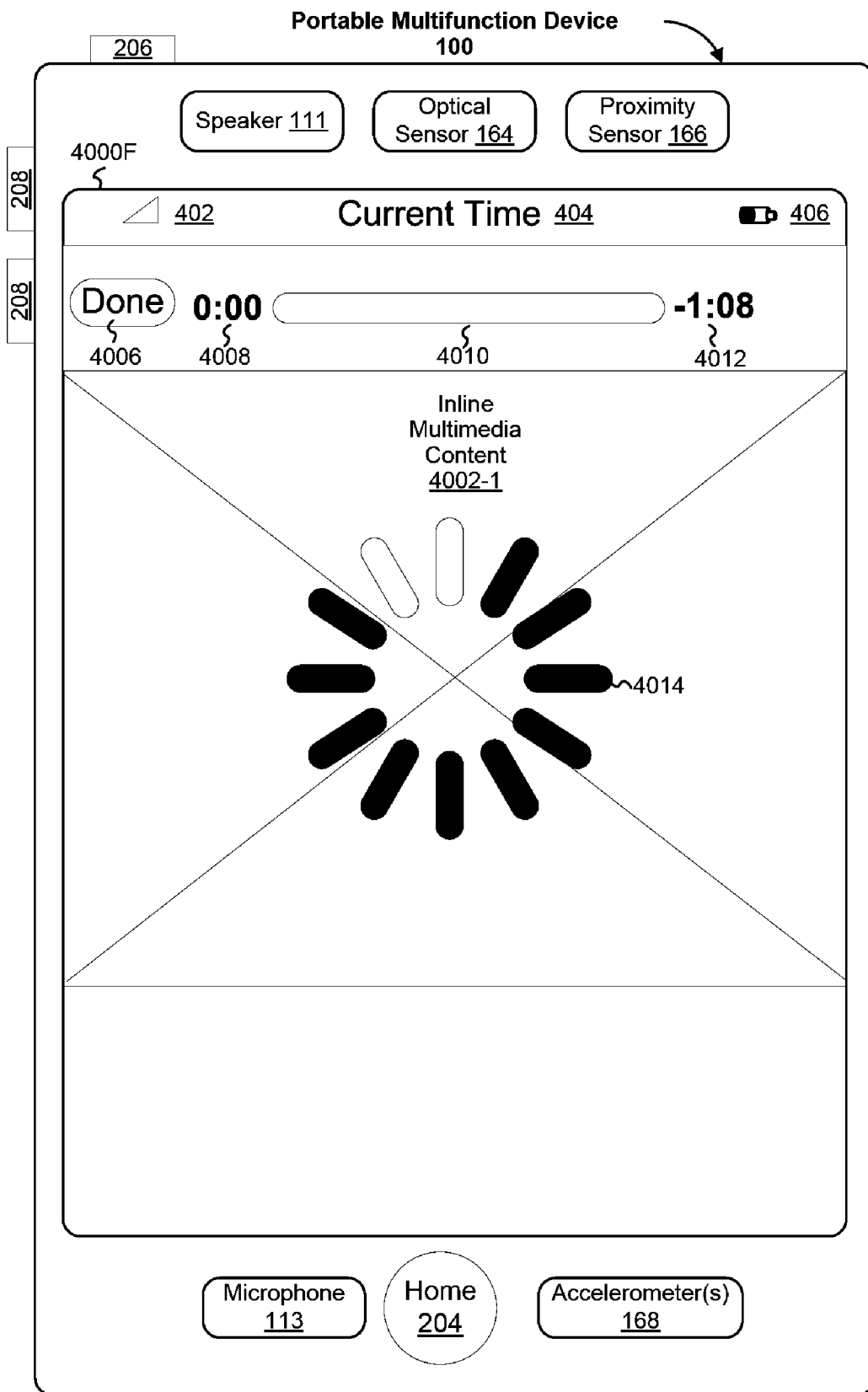

Figure 40F

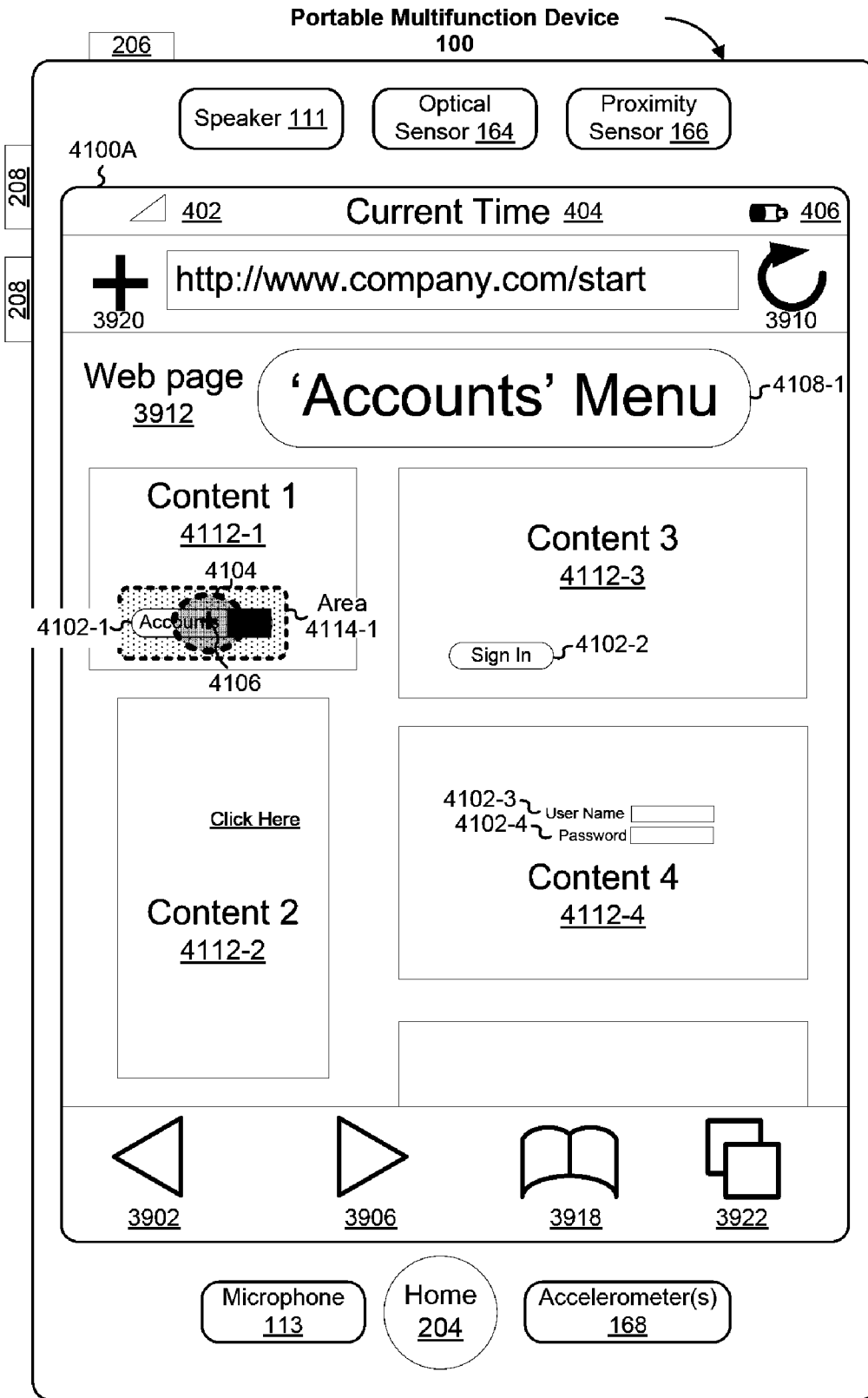

Figure 41A

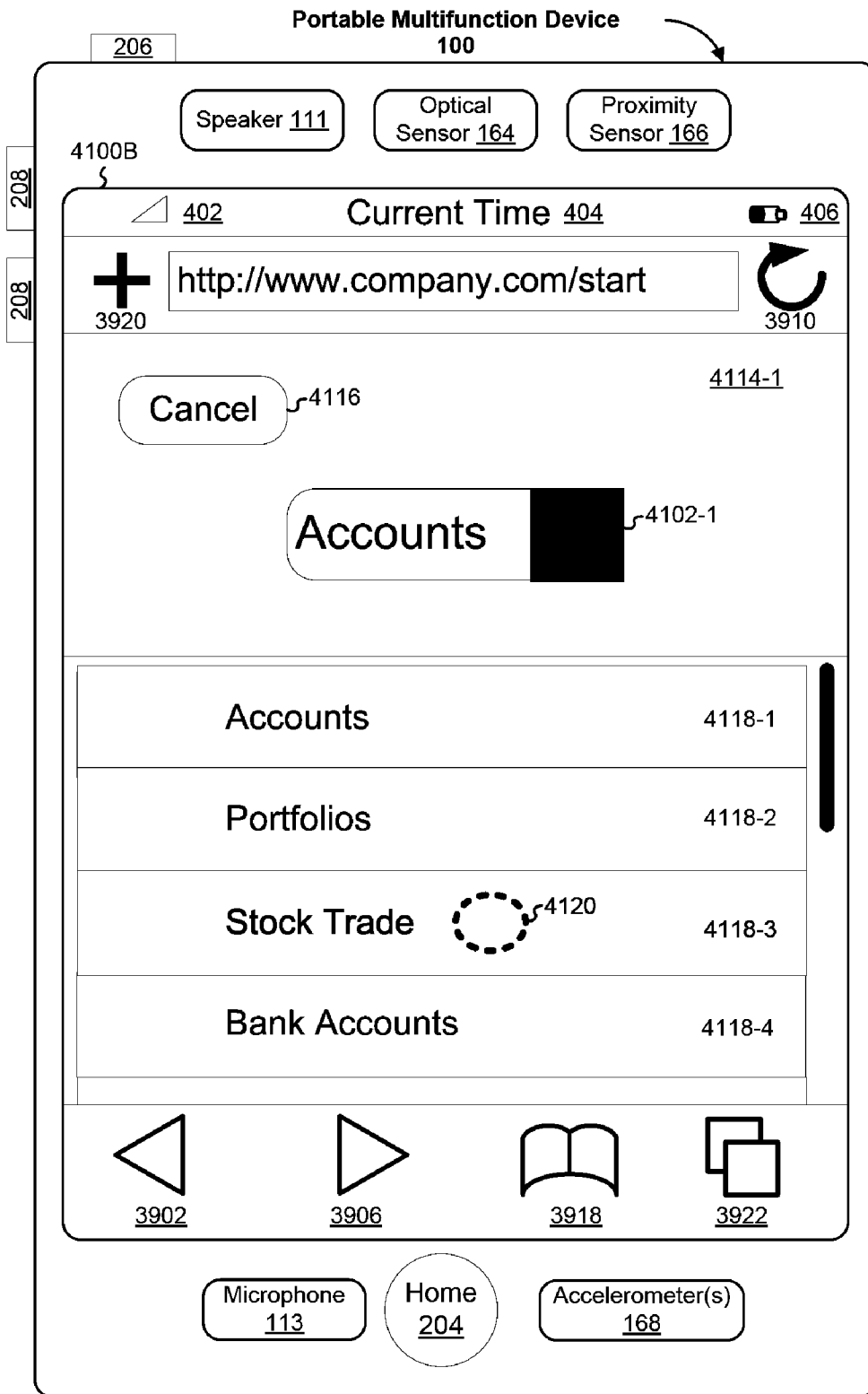

Figure 41B

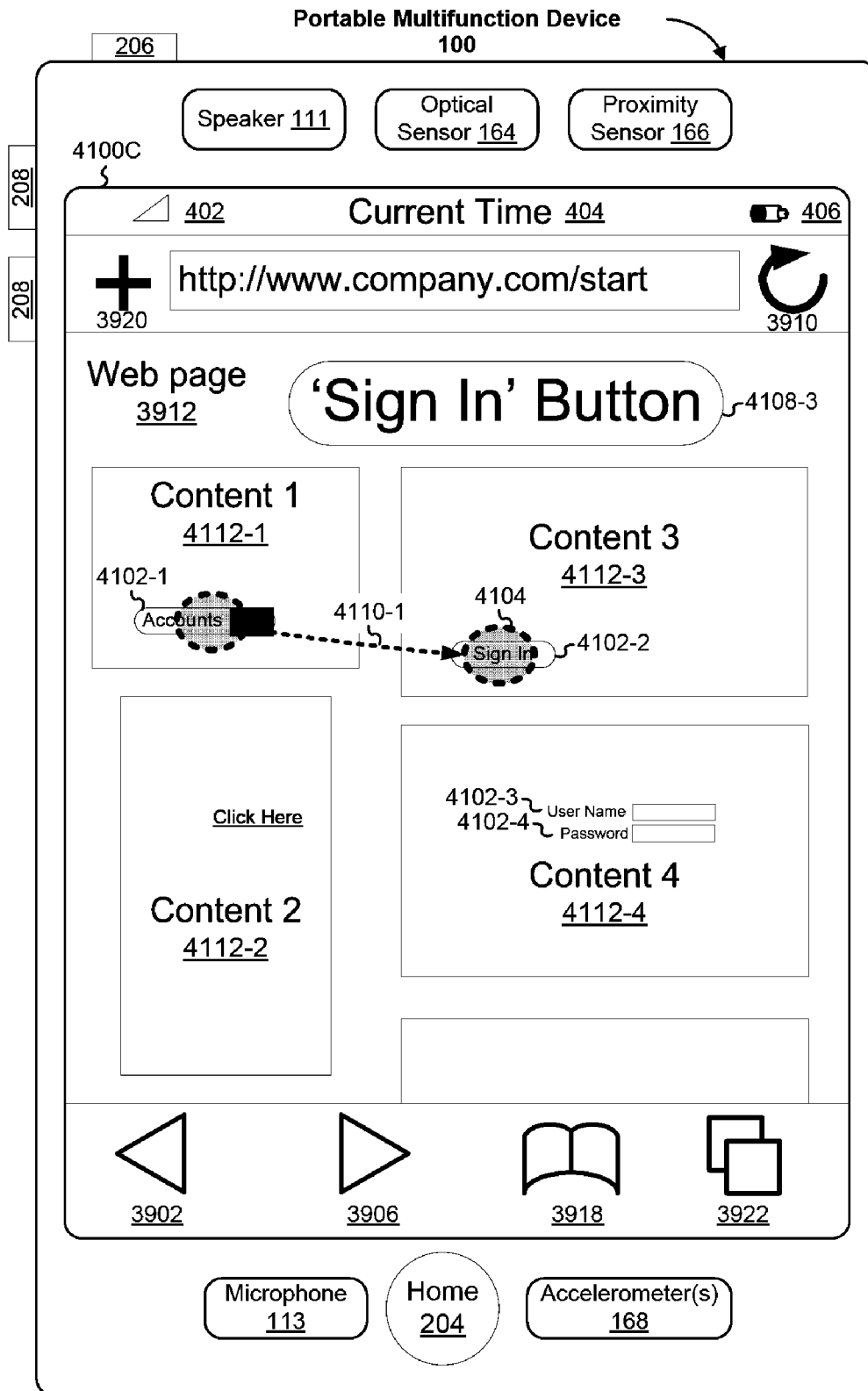

Figure 41C

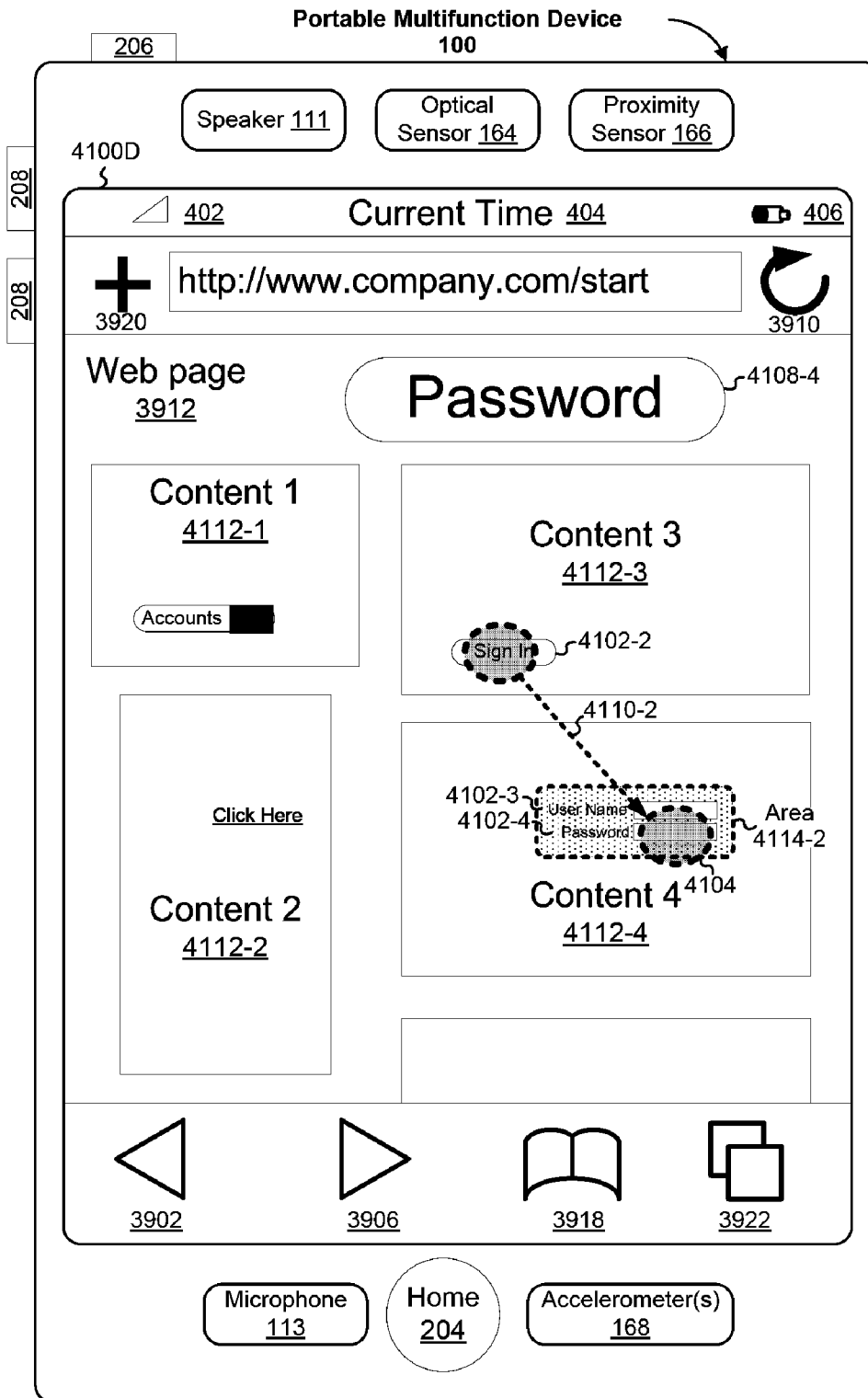

Figure 41D

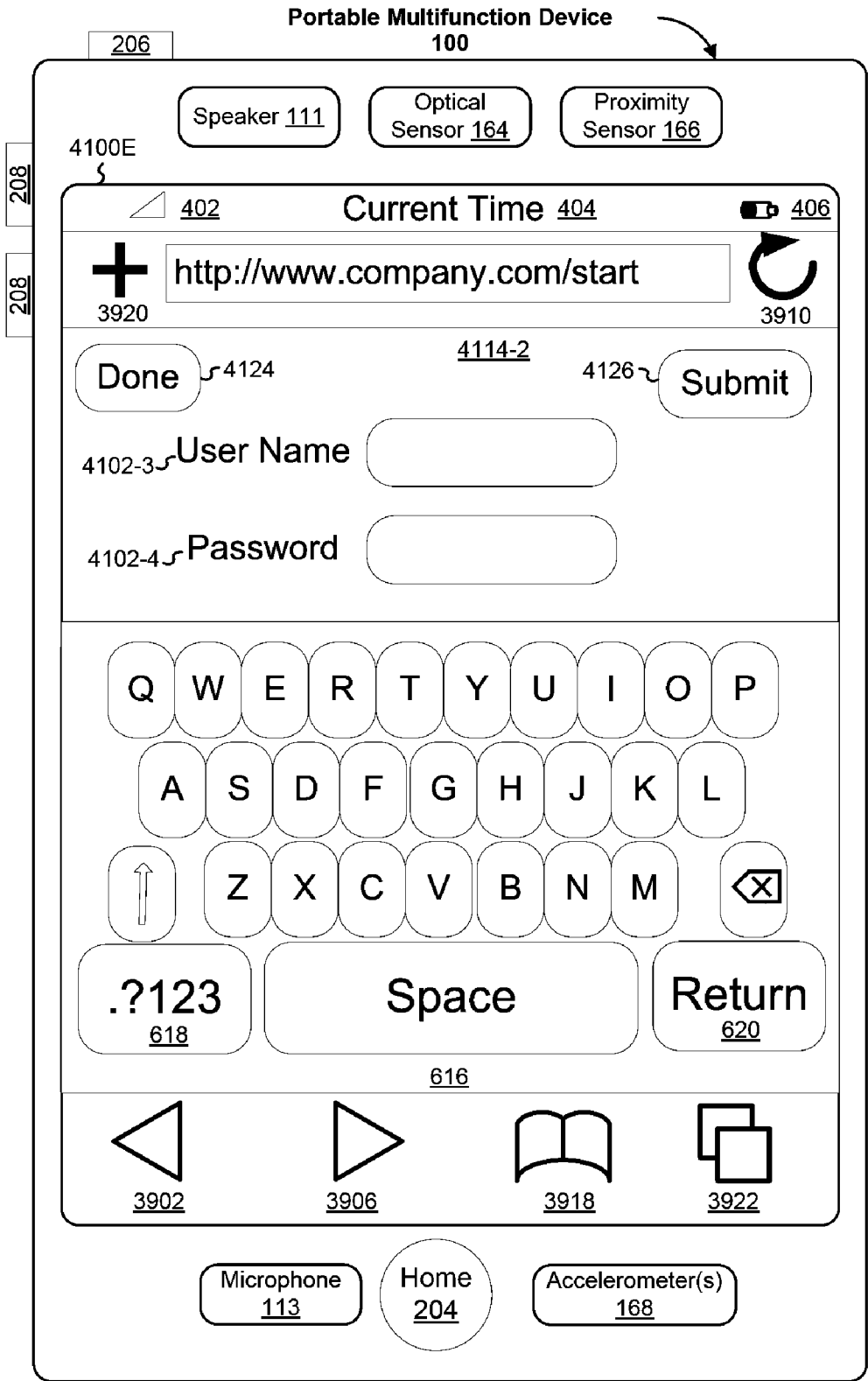

Figure 41E

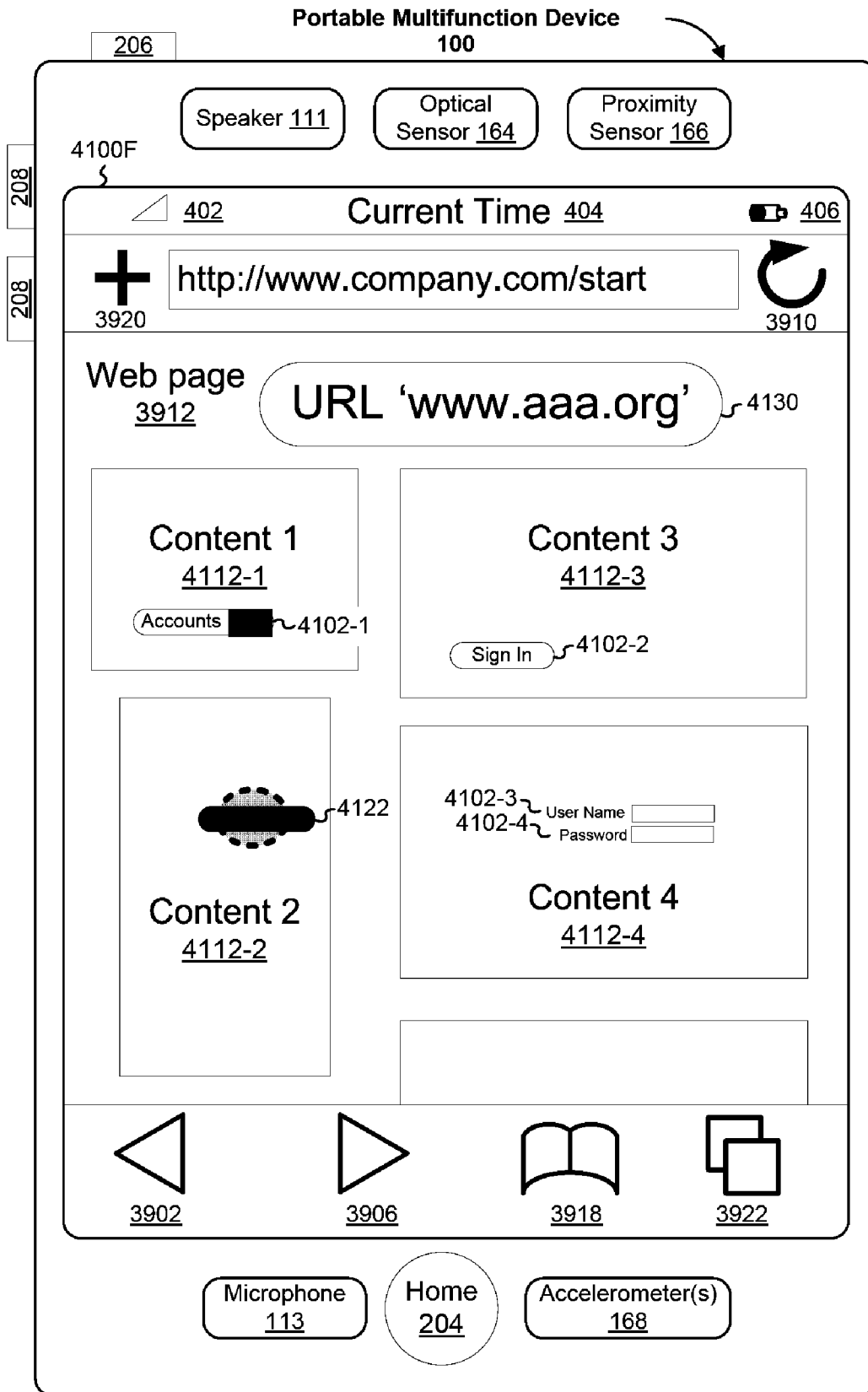

Figure 41F

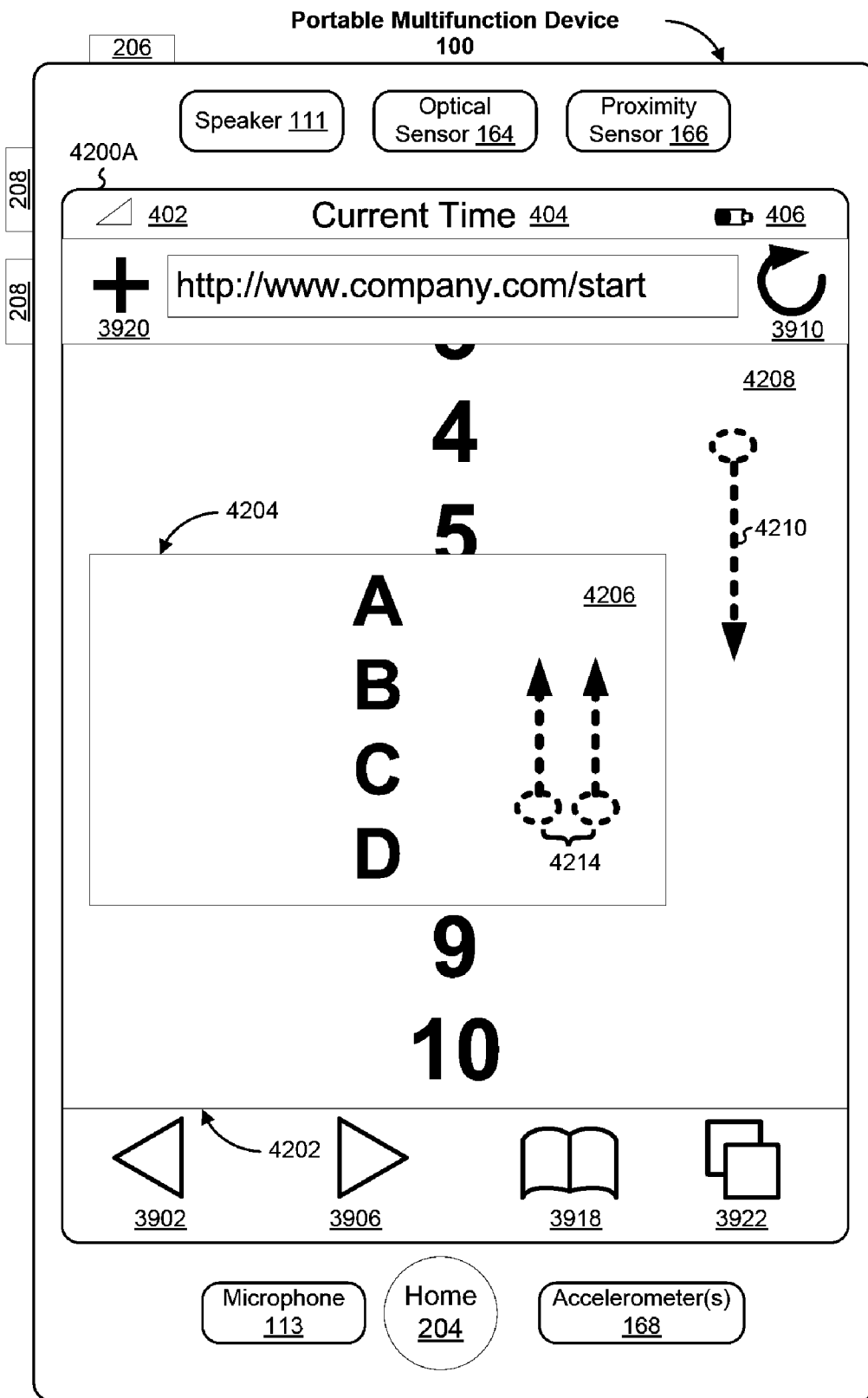

Figure 42A



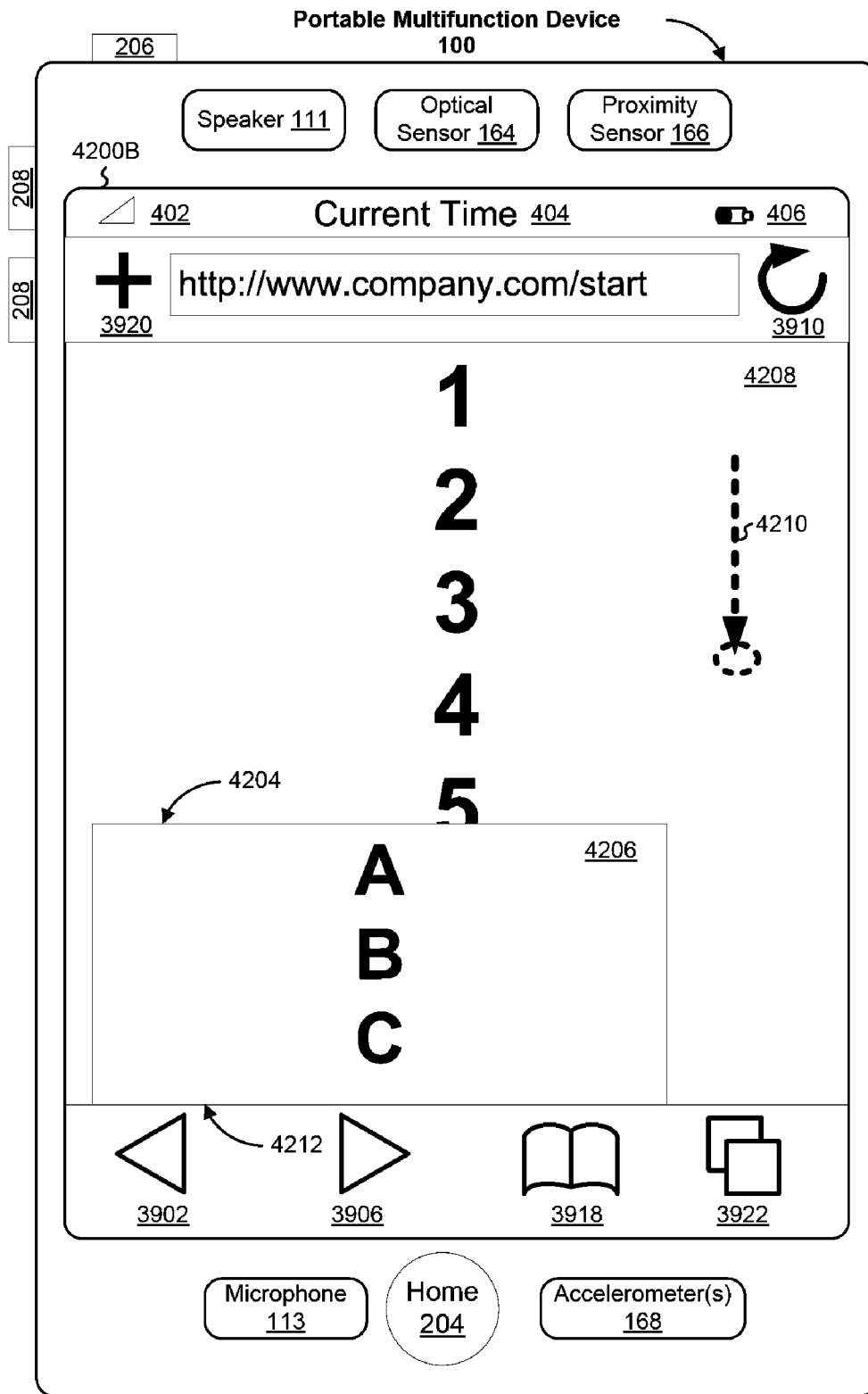

Figure 42B

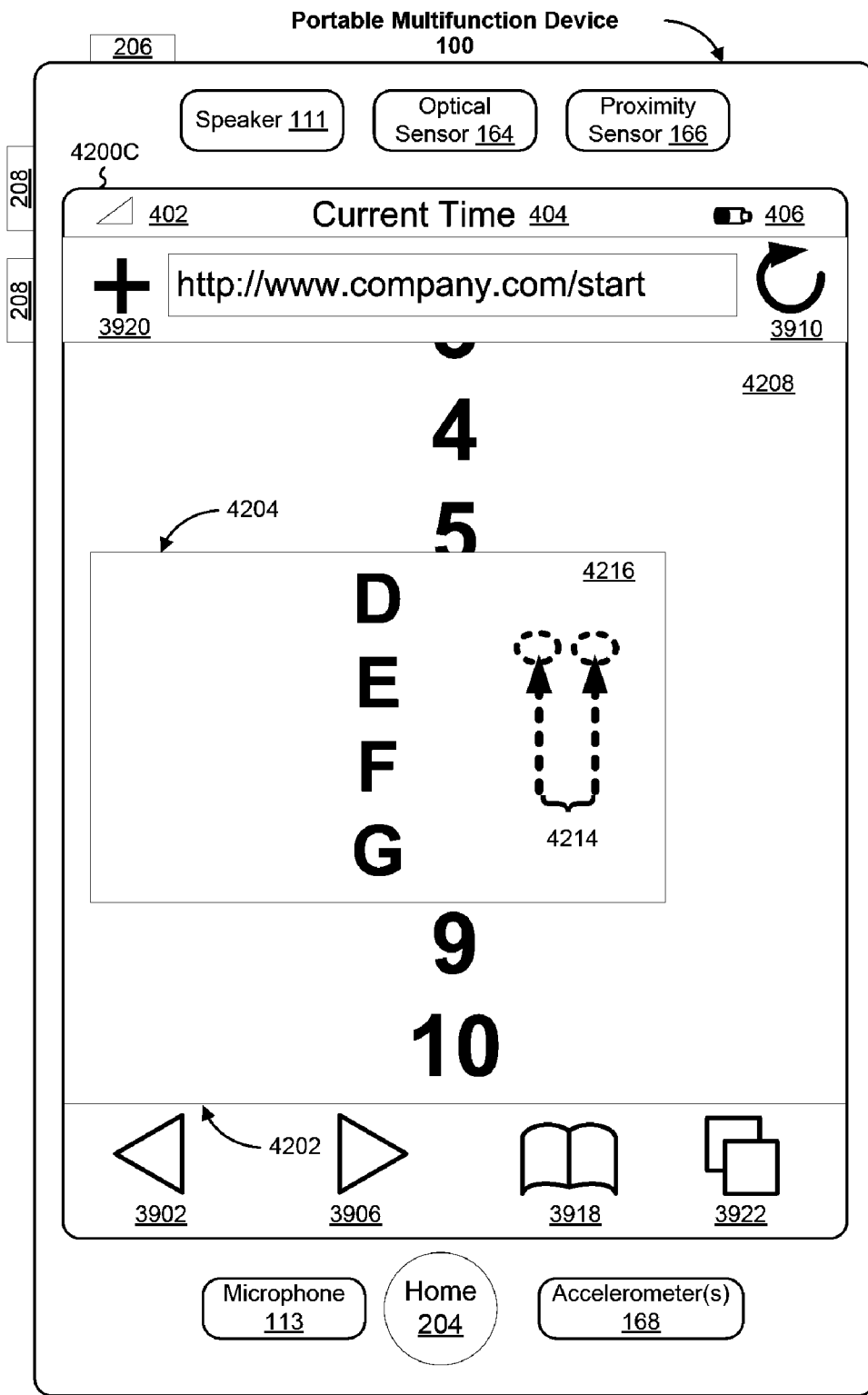

Figure 42C



Figure 43A



Figure 43B



Figure 43C

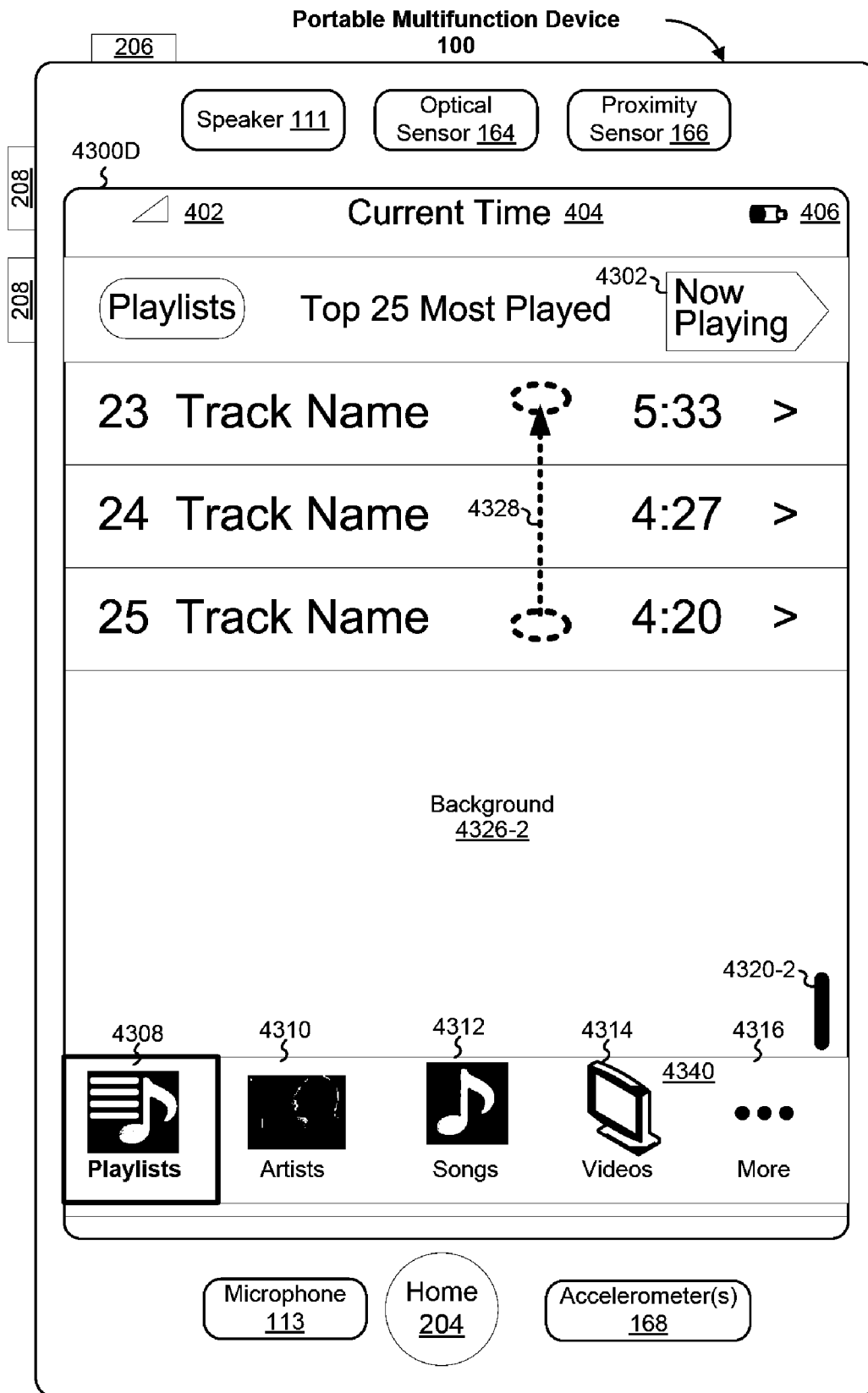

Figure 43D

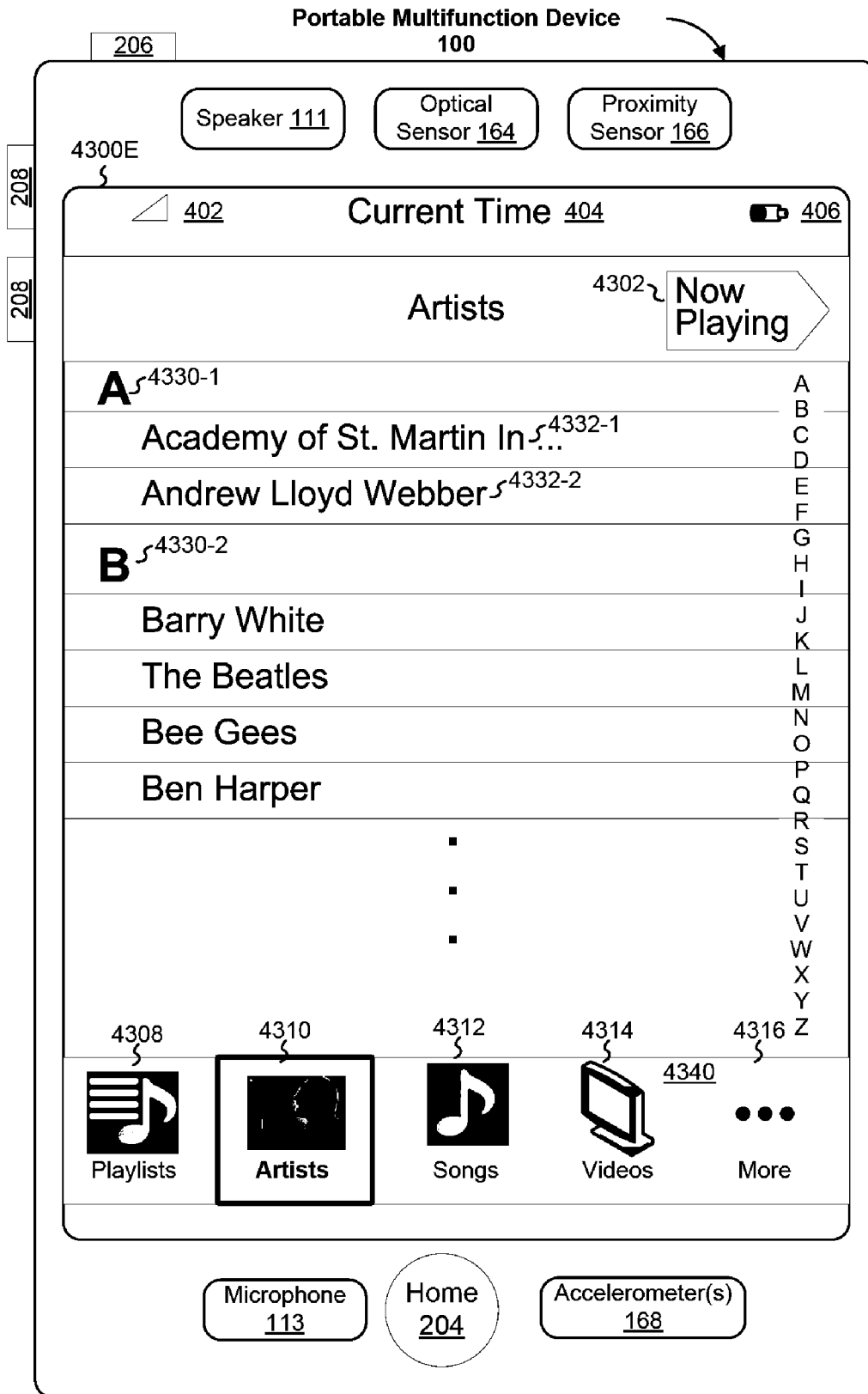

Figure 43E

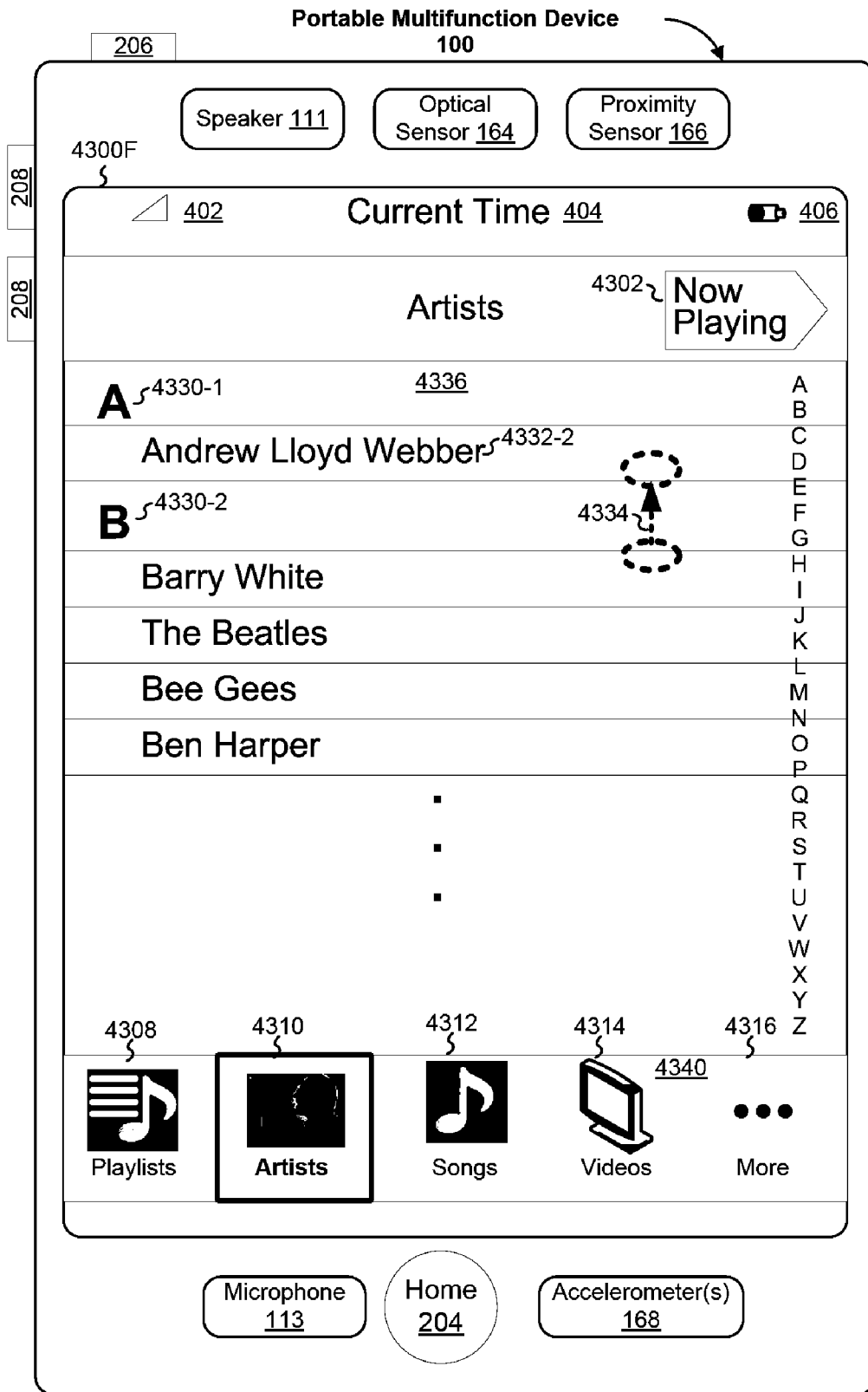

Figure 43F



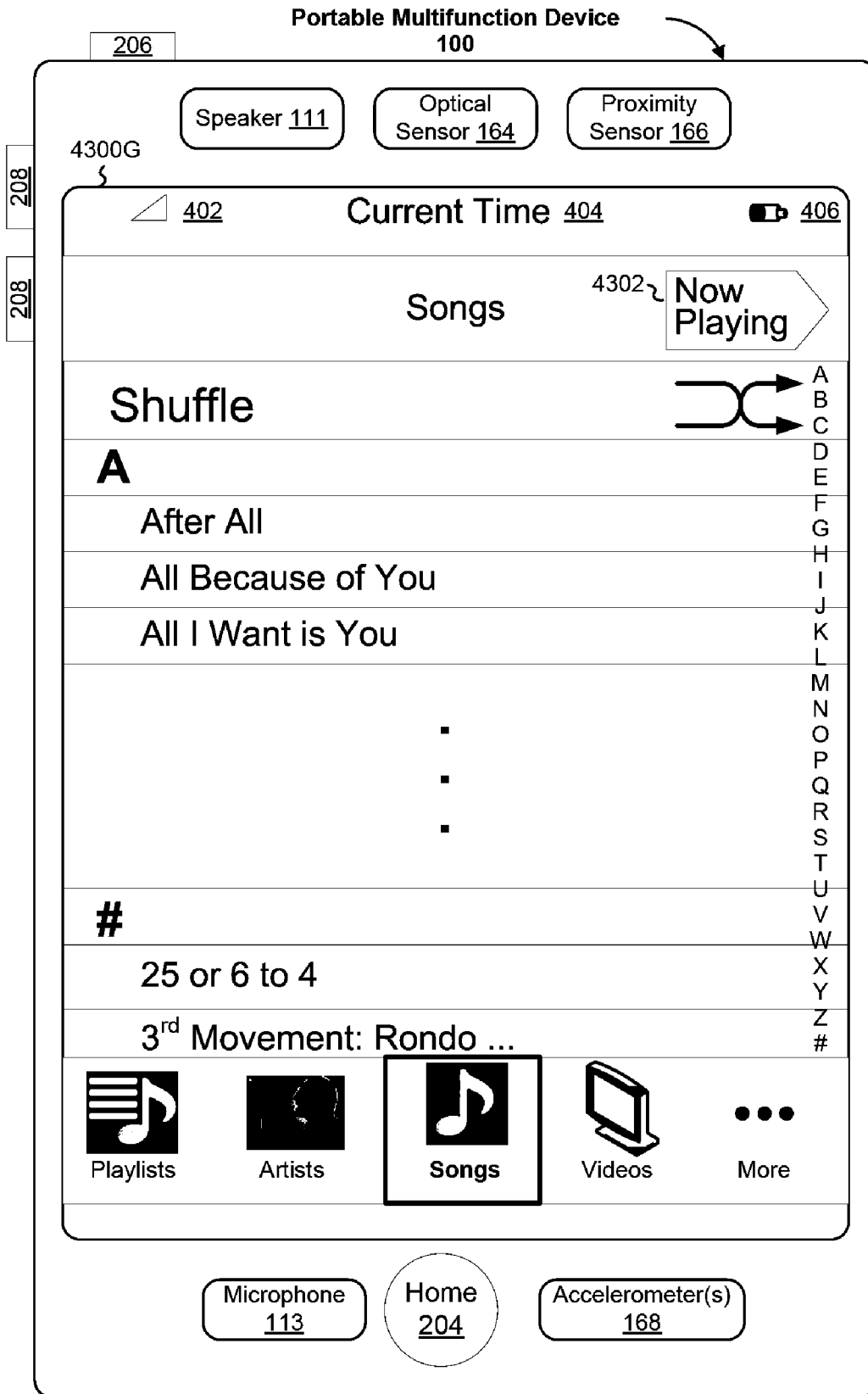

Figure 43G

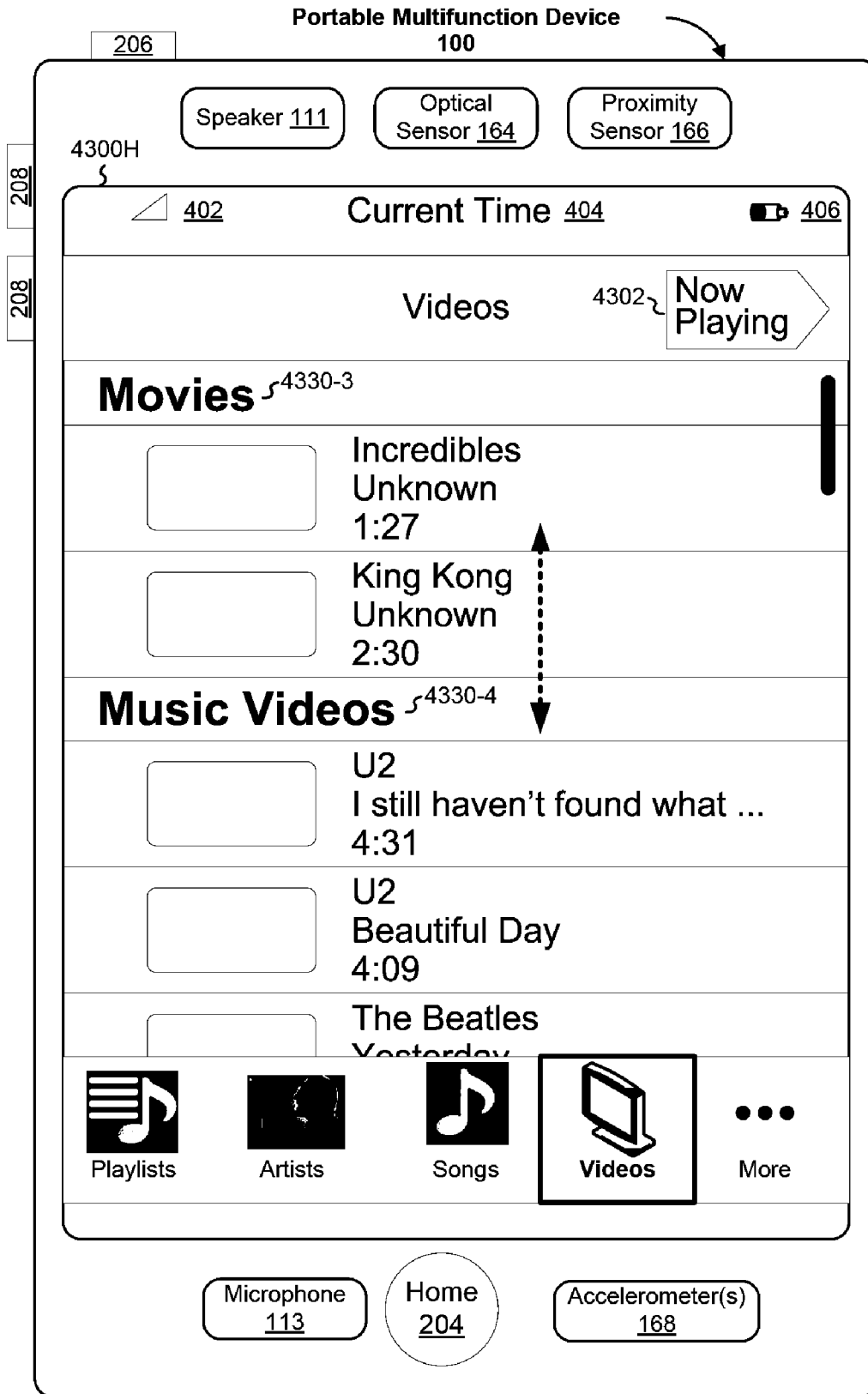

Figure 43H

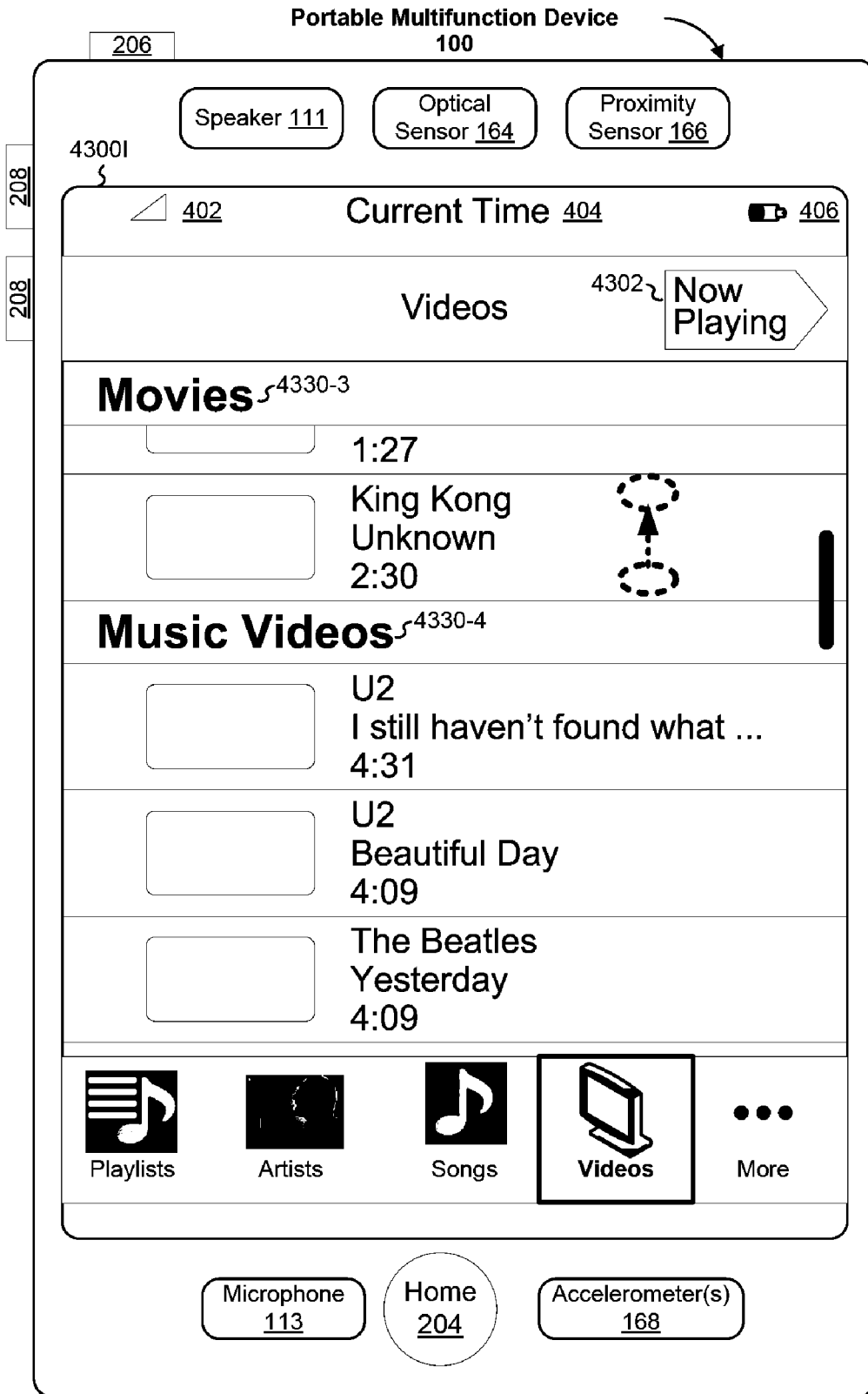

Figure 43I

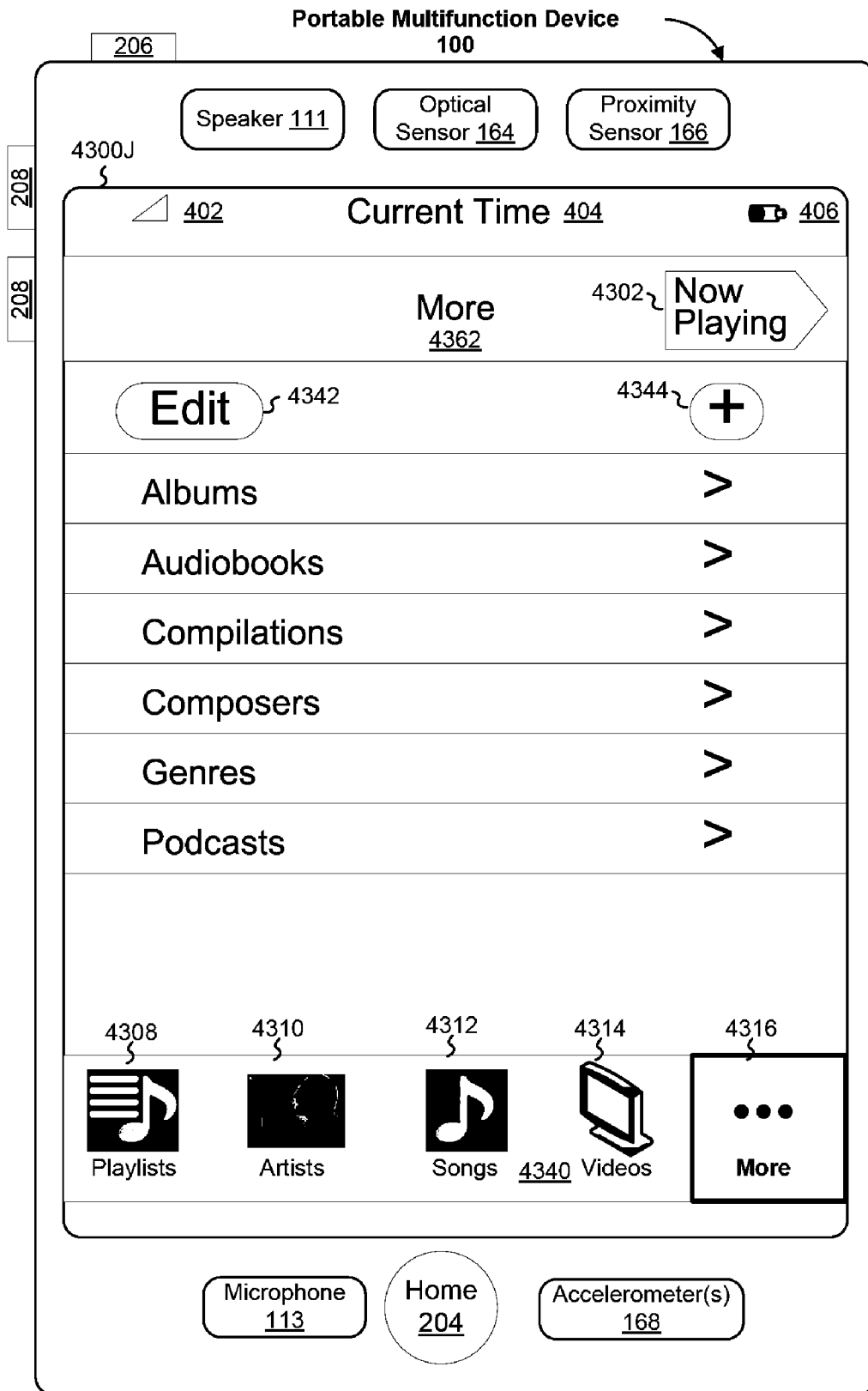

Figure 43J

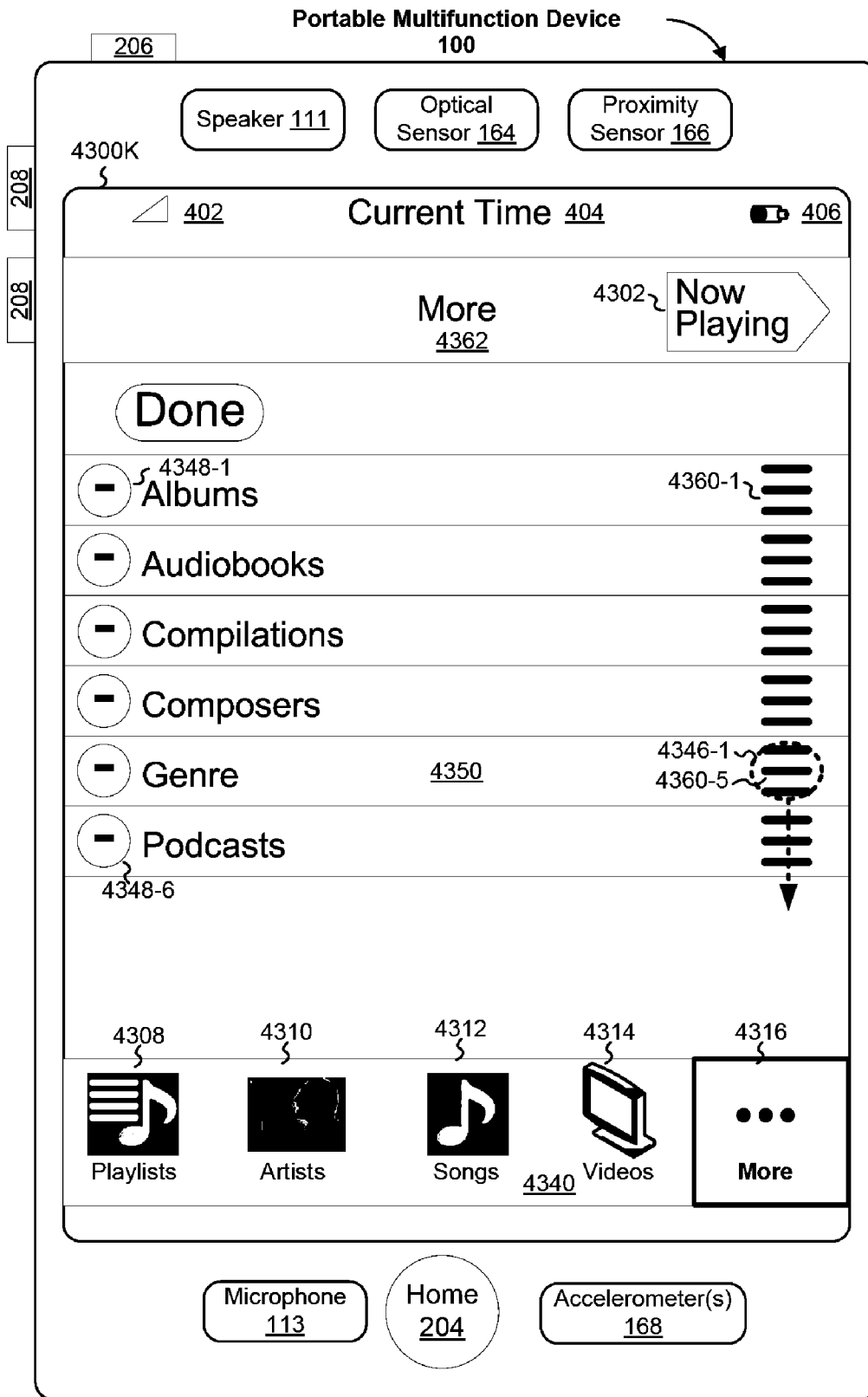

Figure 43K

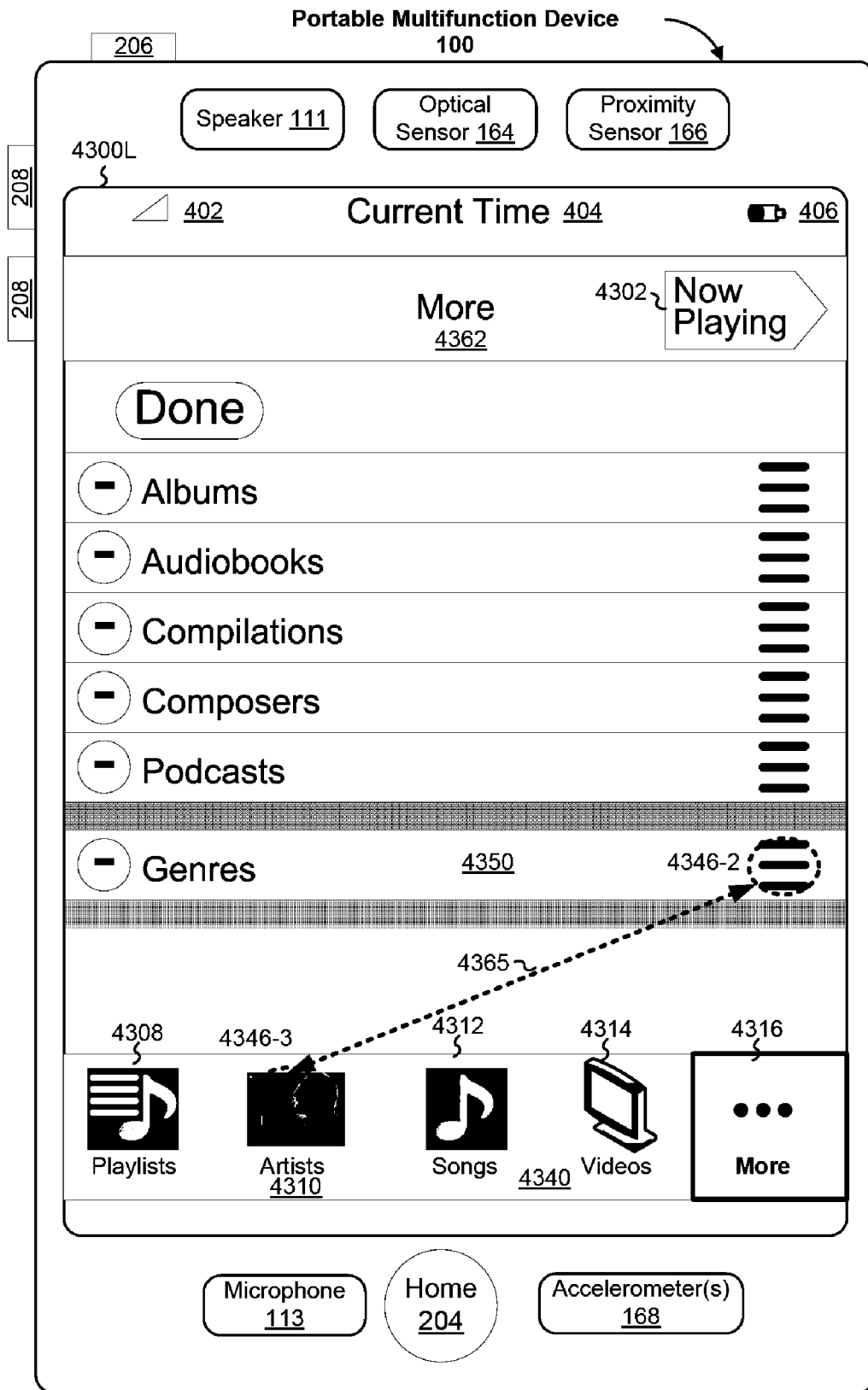

Figure 43L

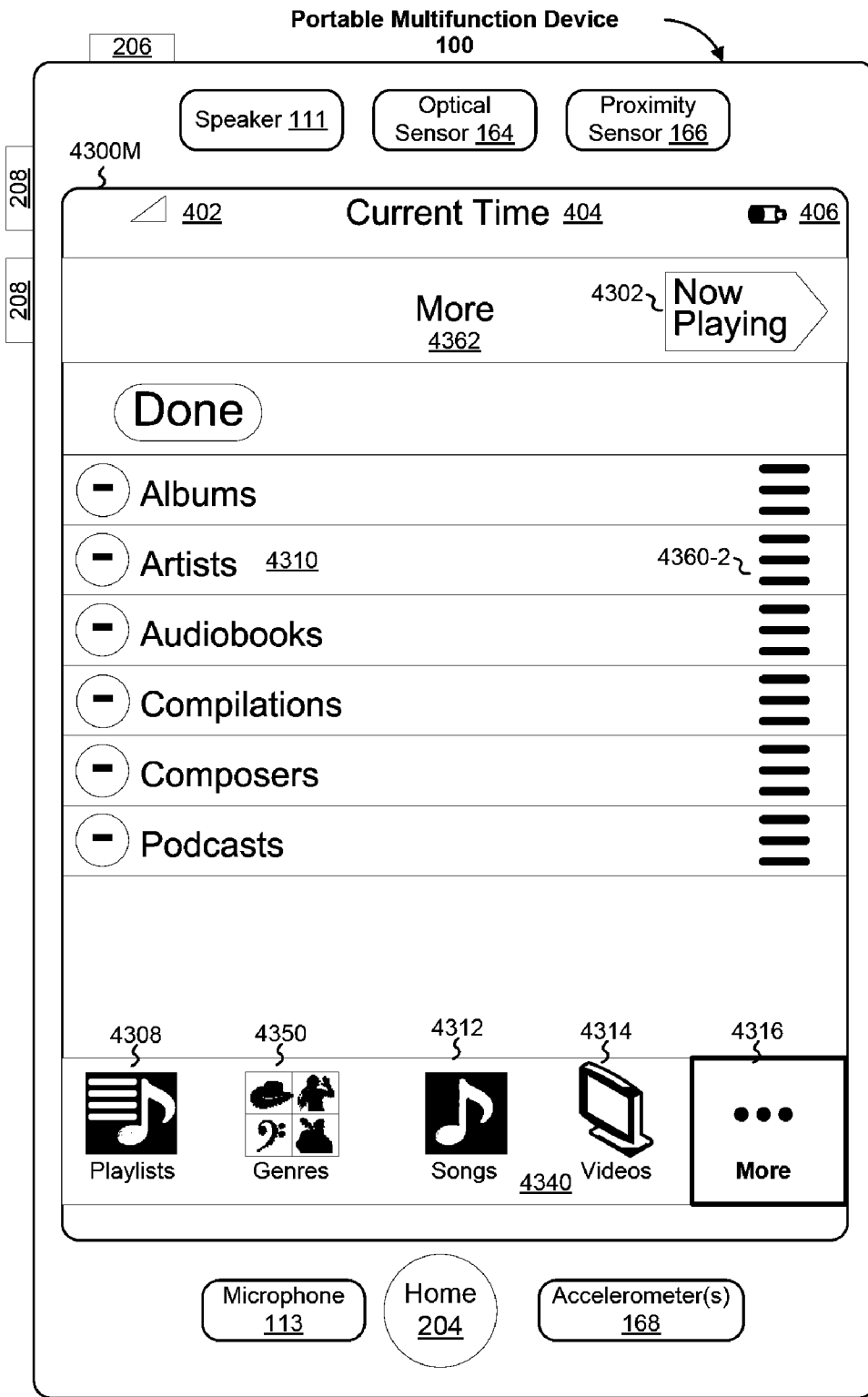

Figure 43M

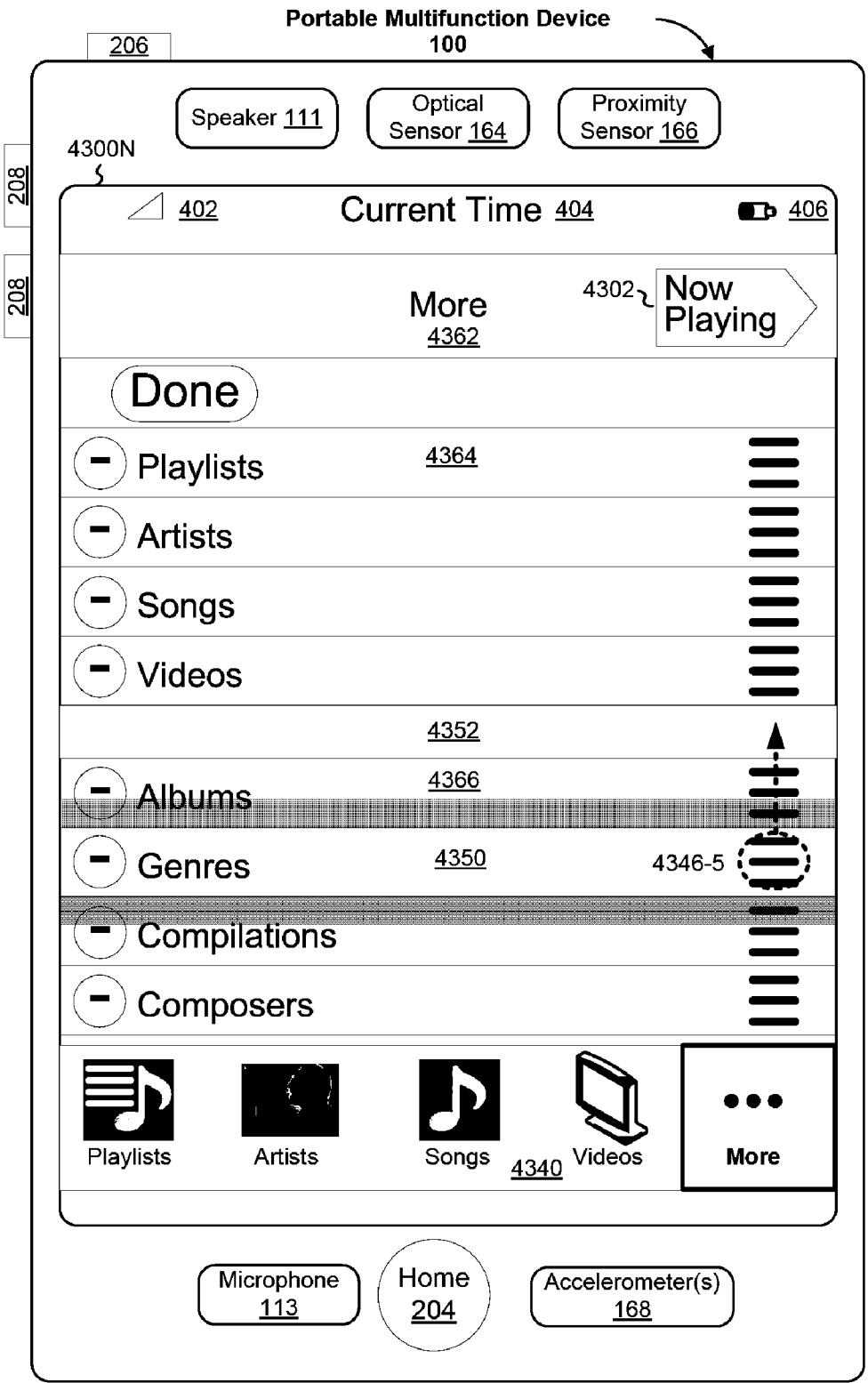

Figure 43N



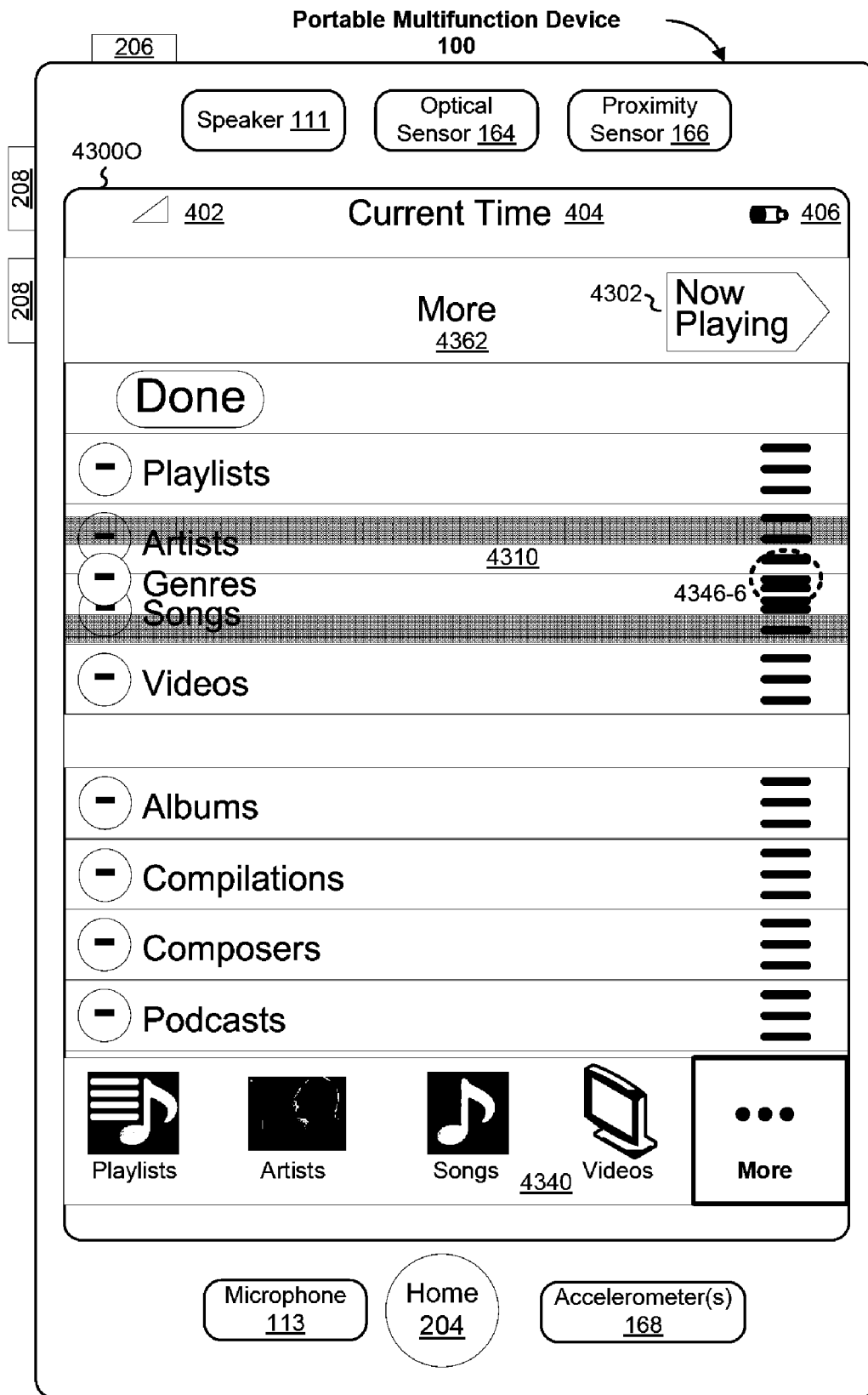

Figure 430

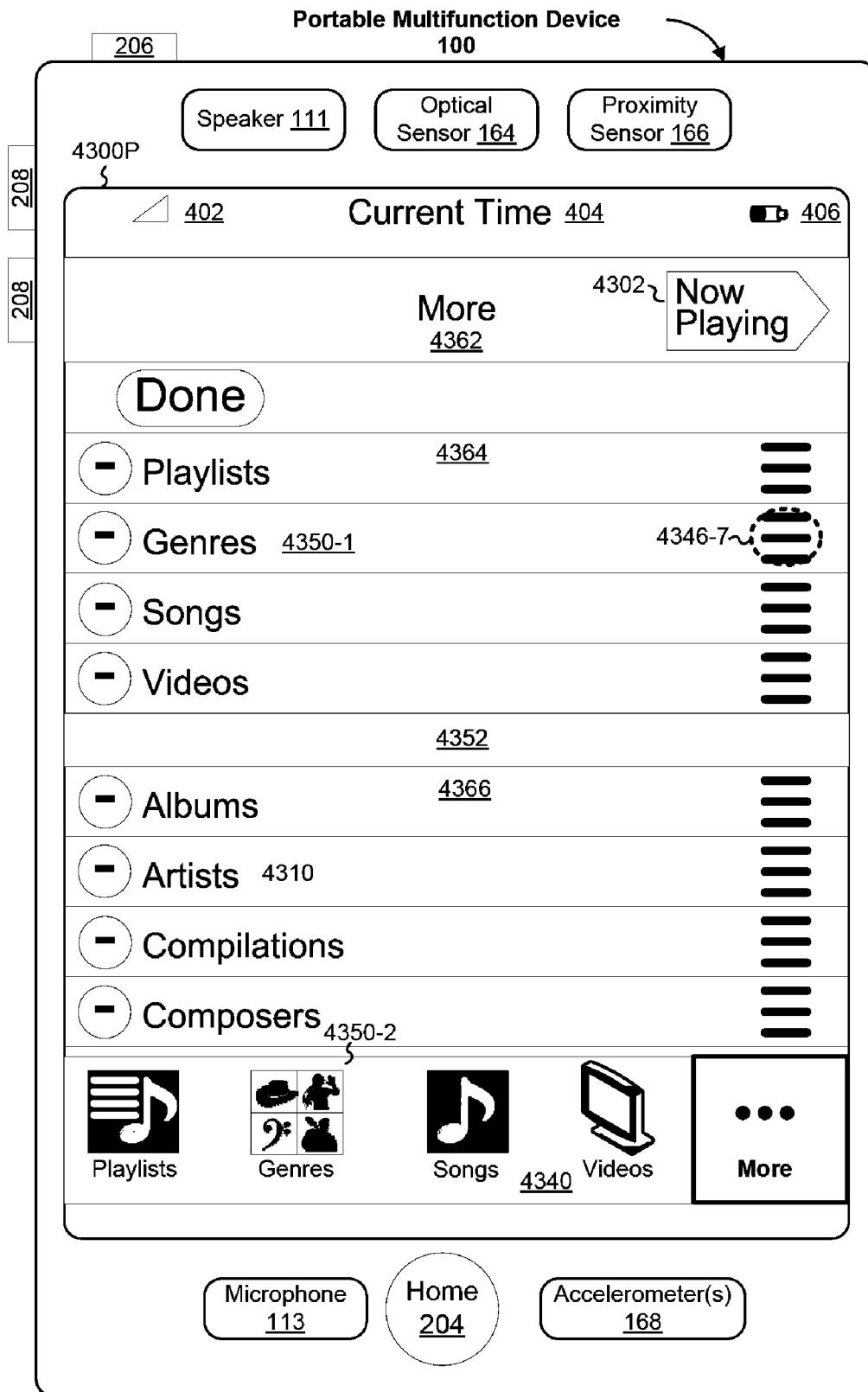

Figure 43P

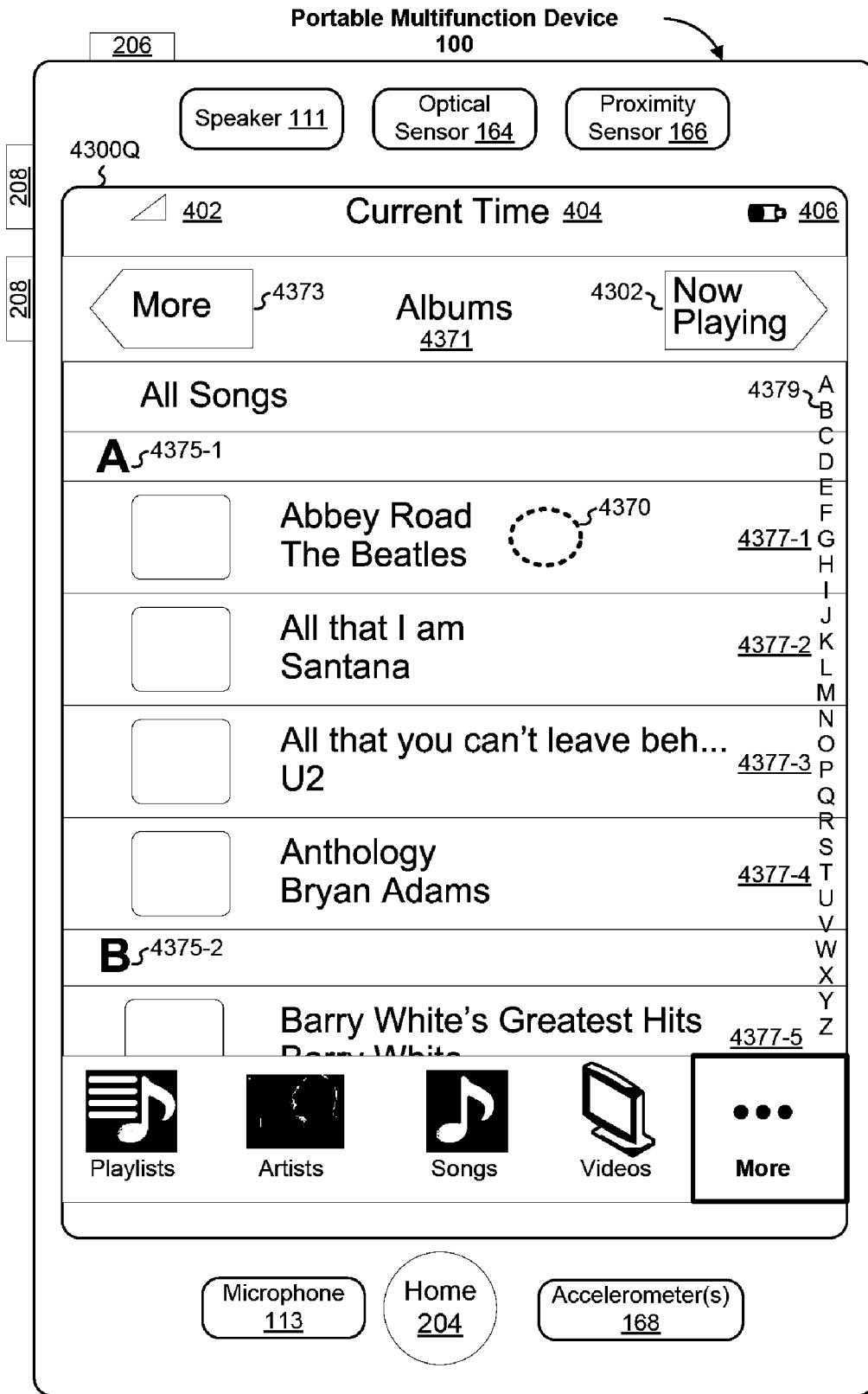

Figure 43Q

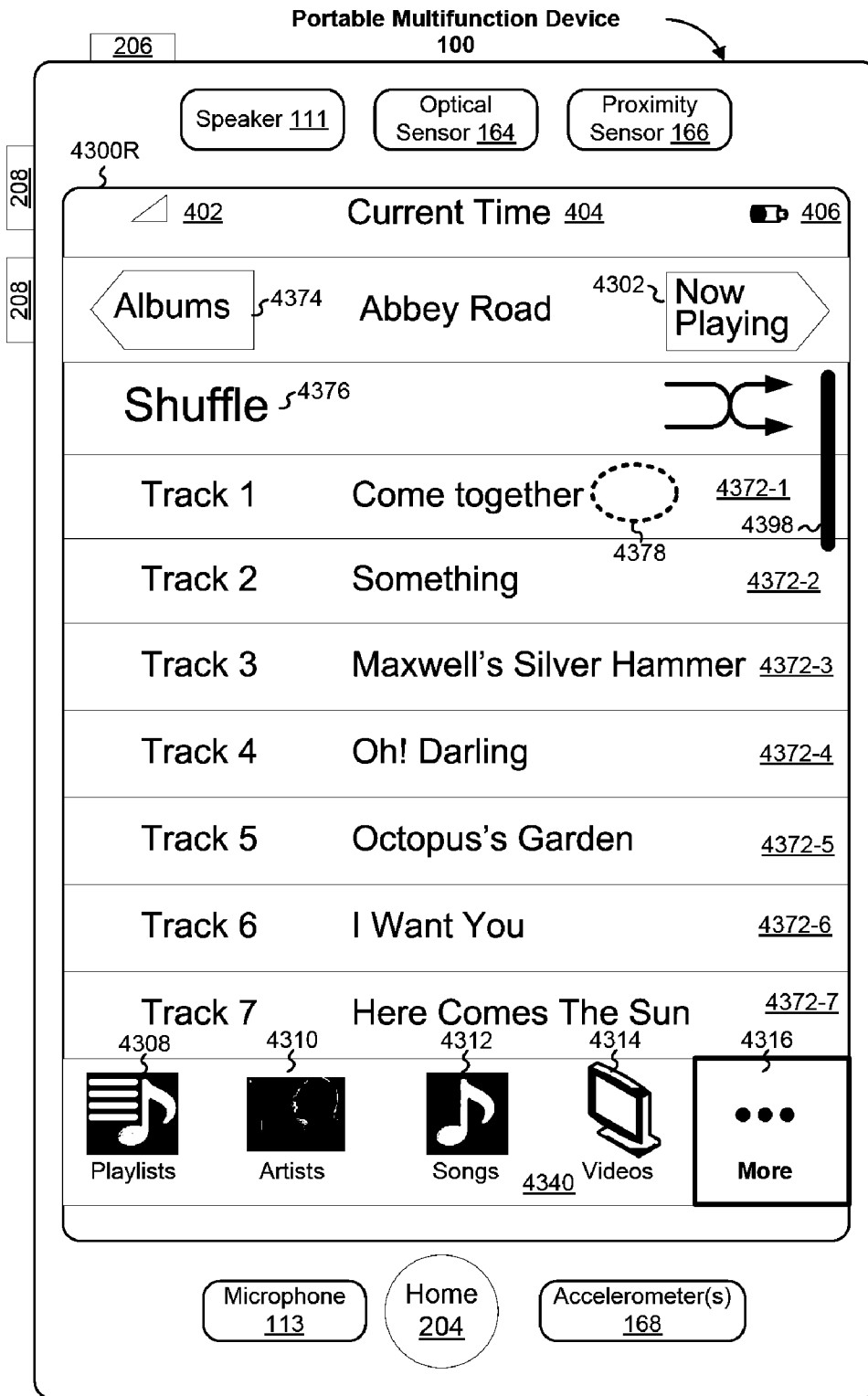

Figure 43R



Figure 43S



Figure 43T

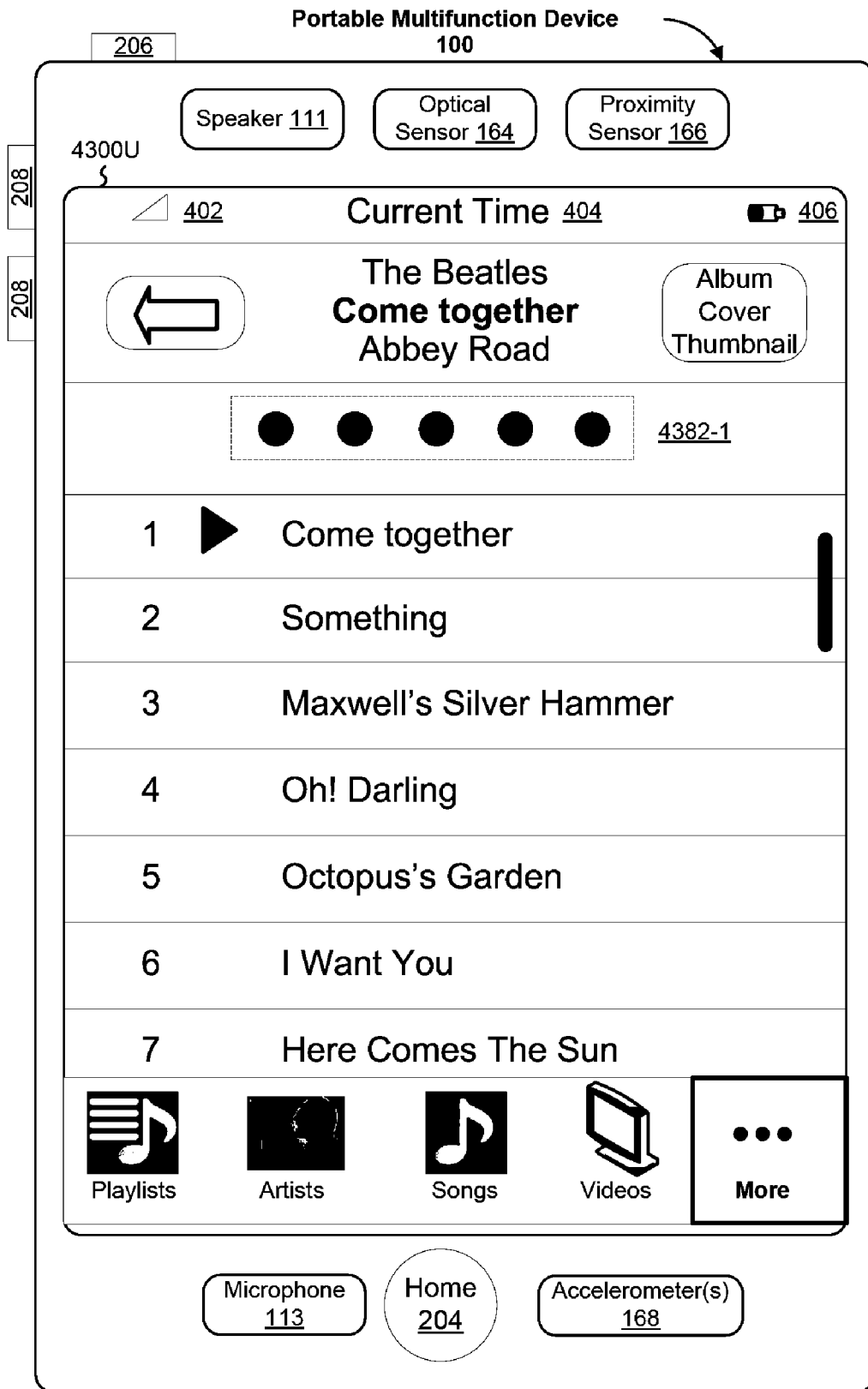

Figure 43U

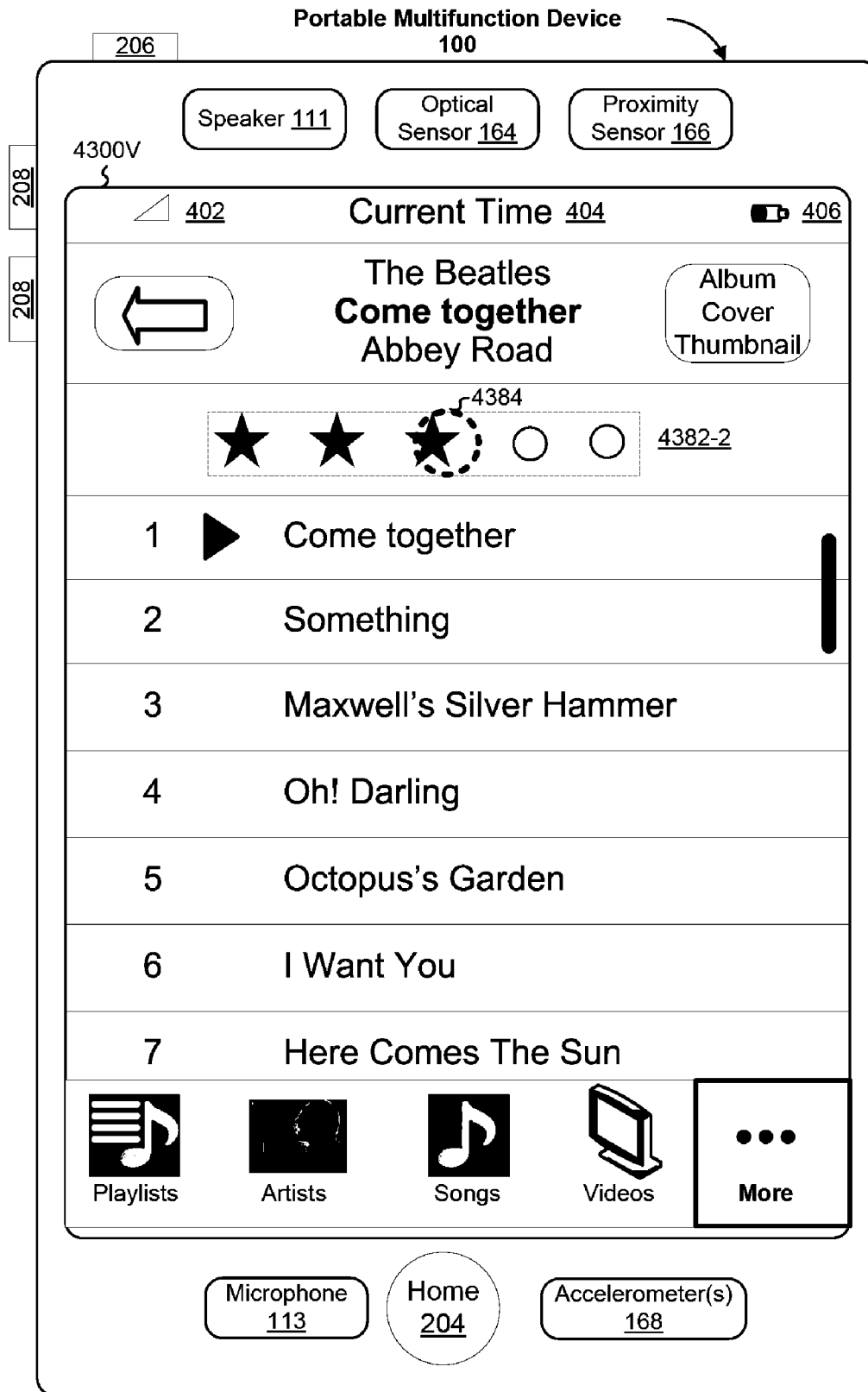

Figure 43V