

Figure 43W

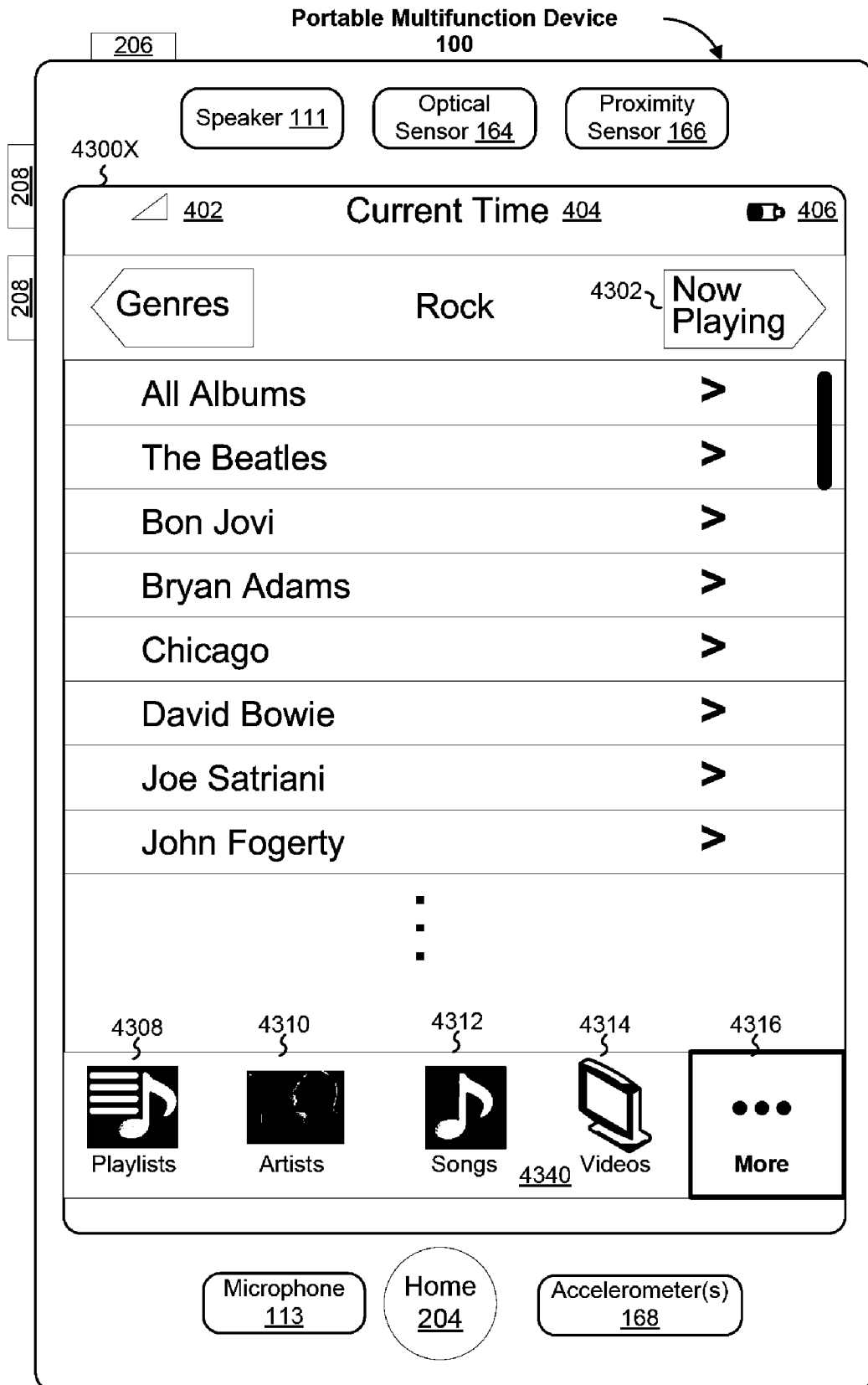

Figure 43X

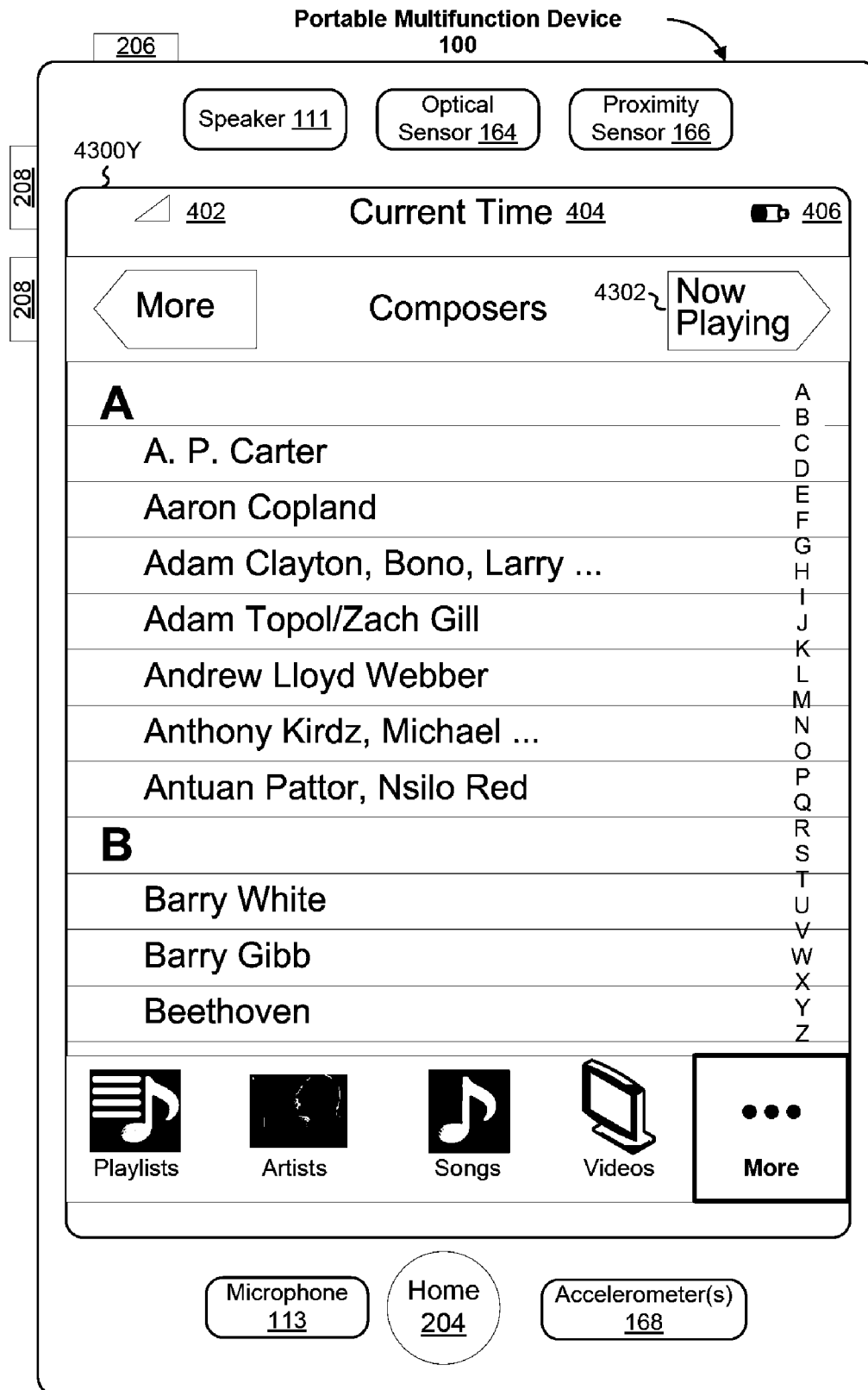

Figure 43Y

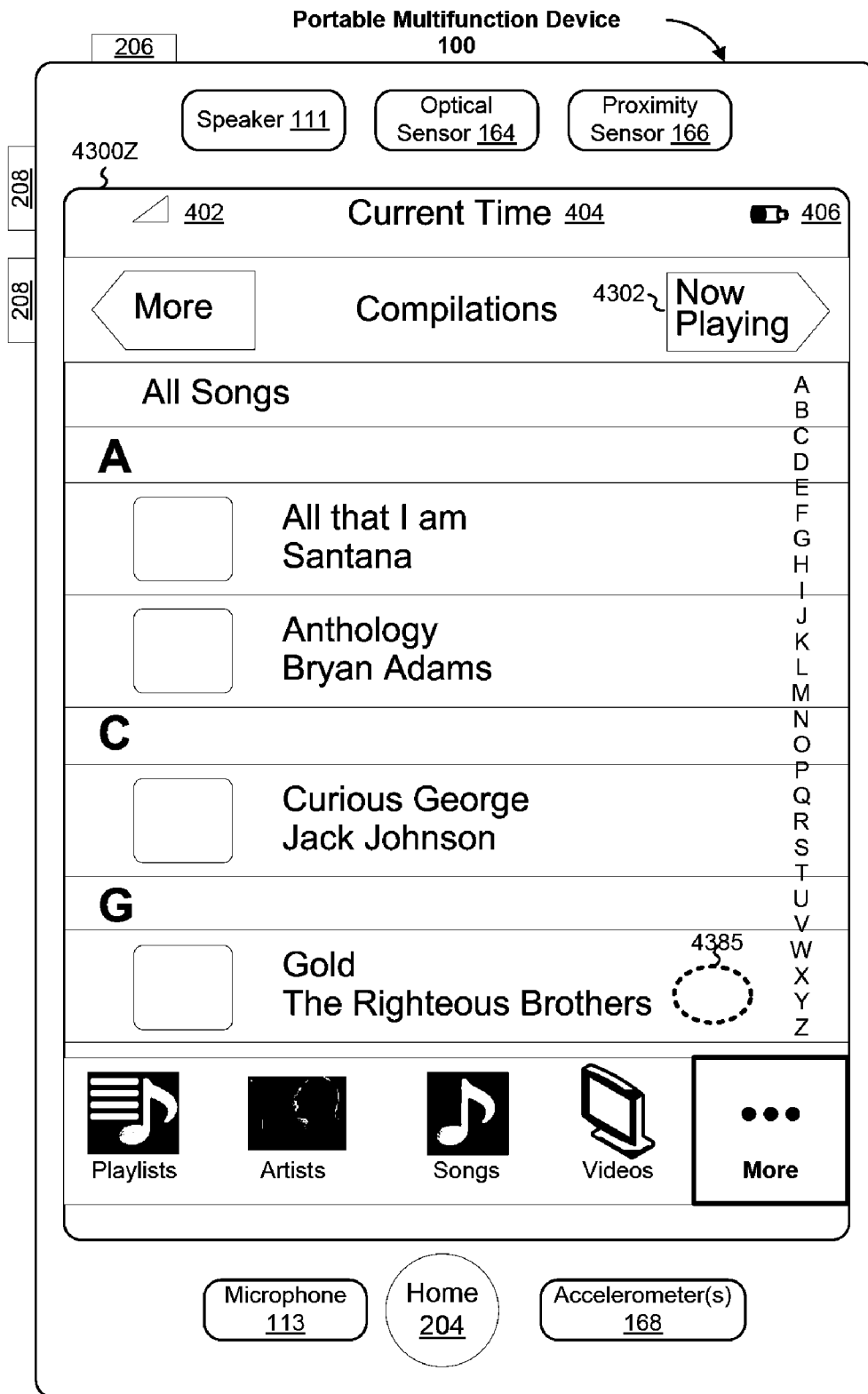

Figure 43Z

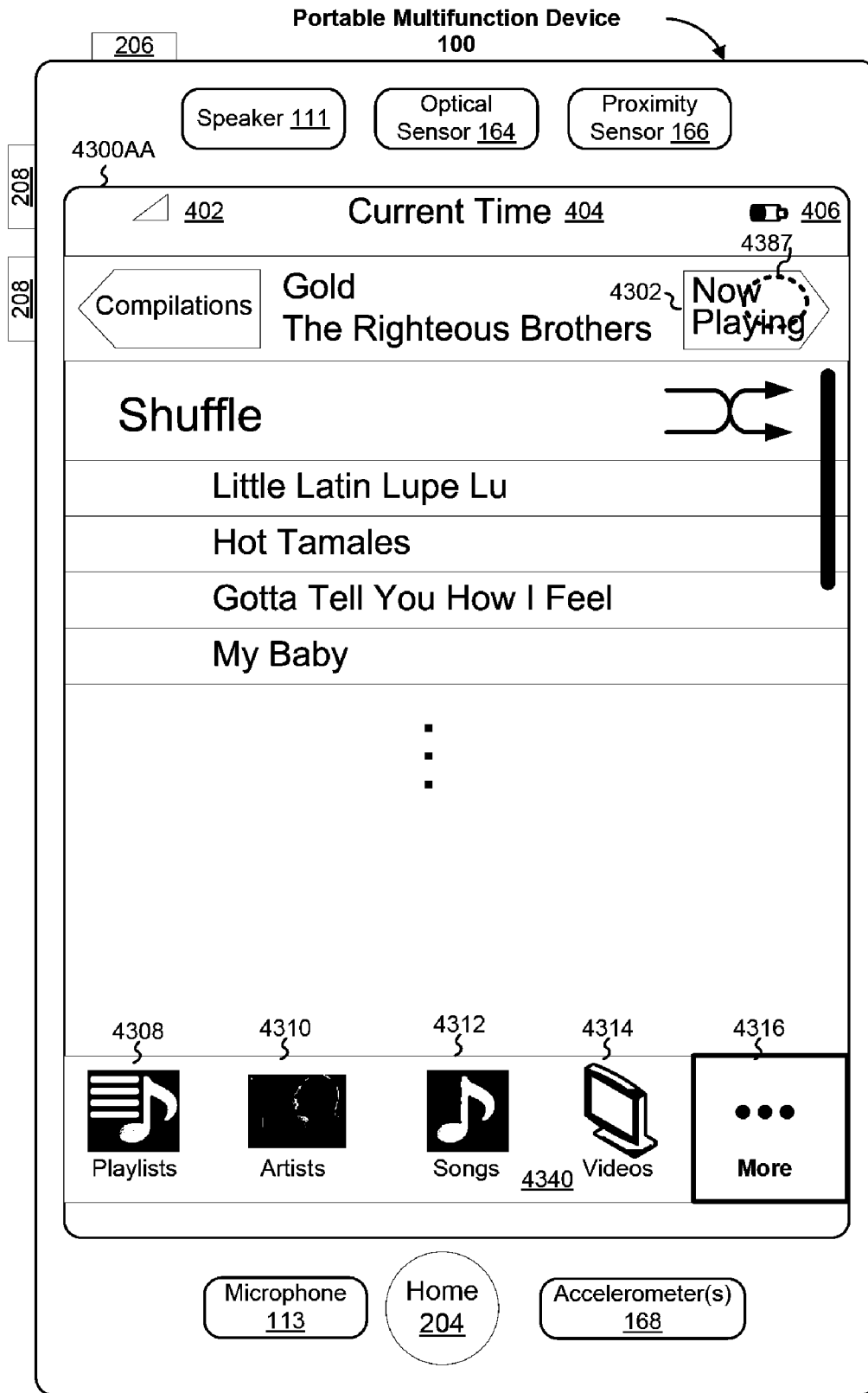

Figure 43AA



Figure 43BB

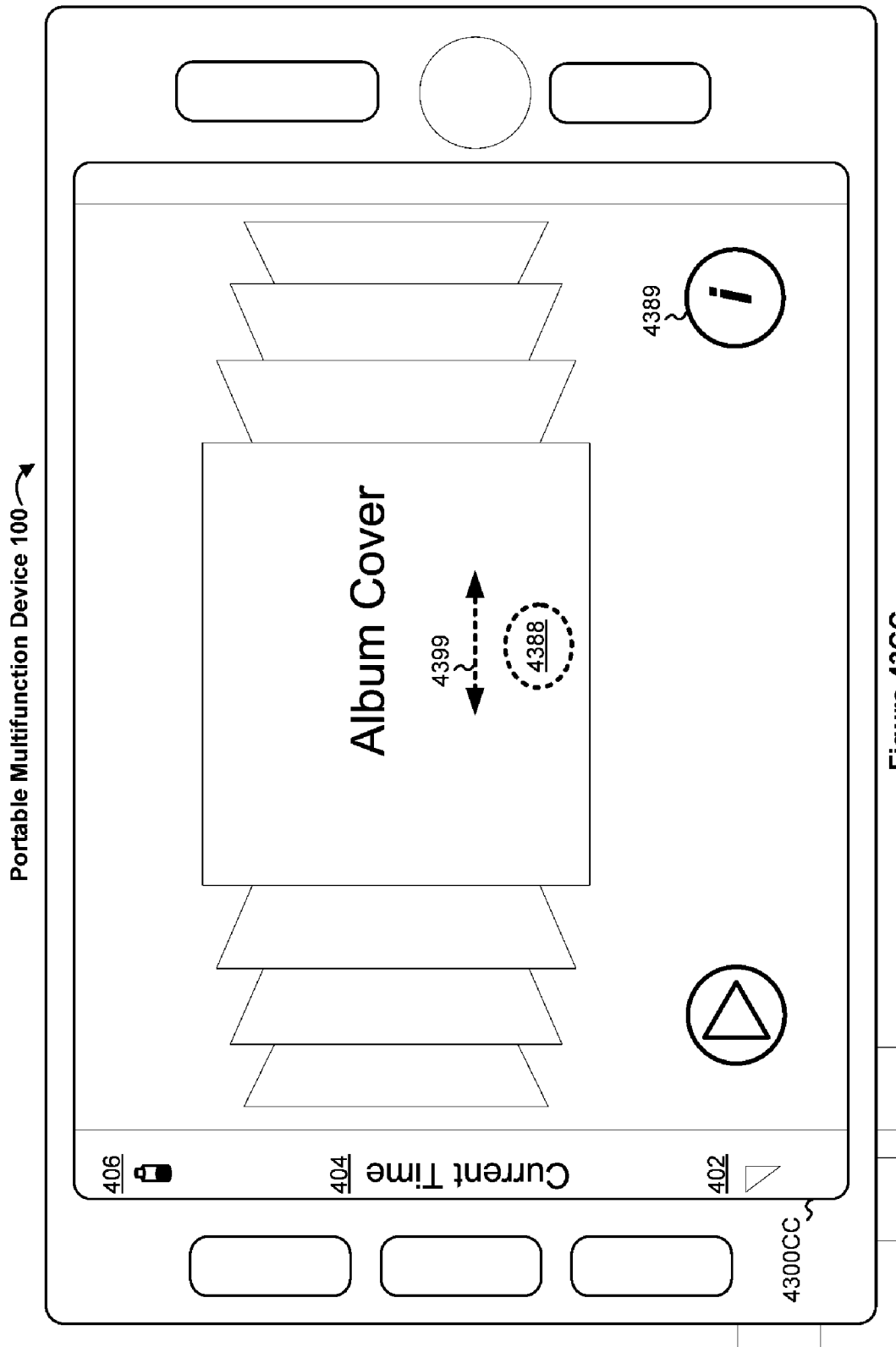

Figure 43CC

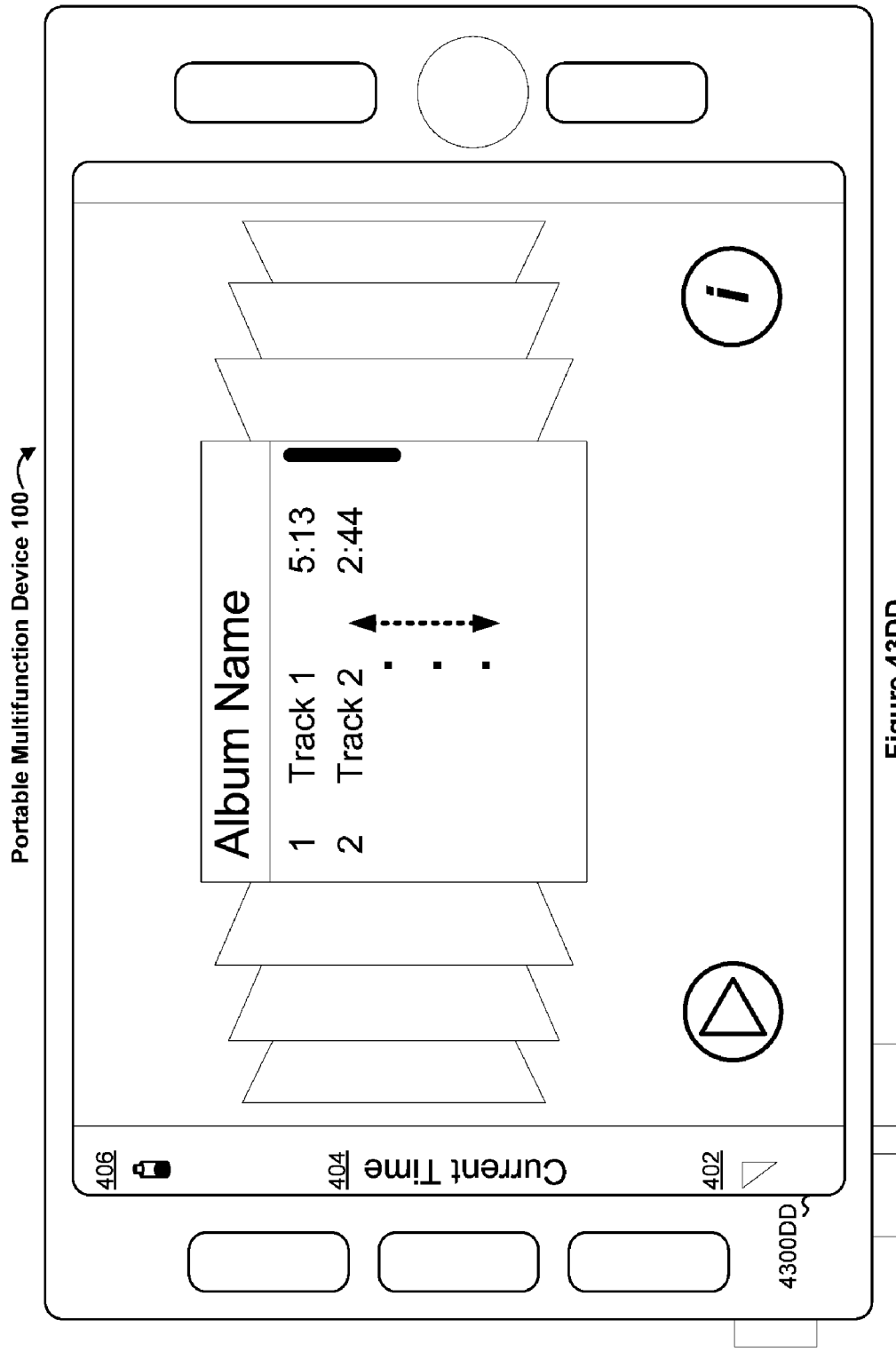

Figure 43DD

Figure 44A

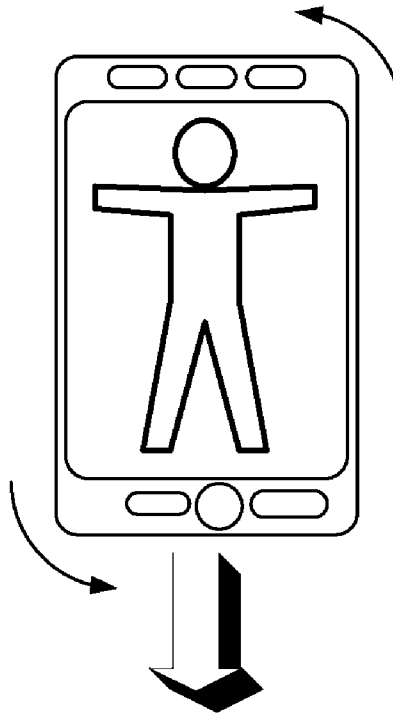

Figure 44B

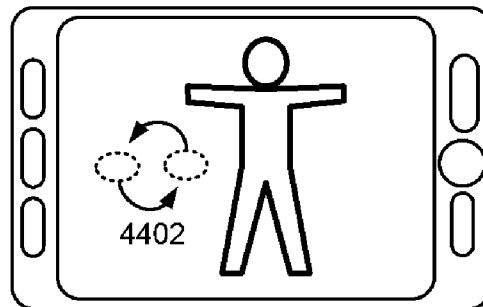
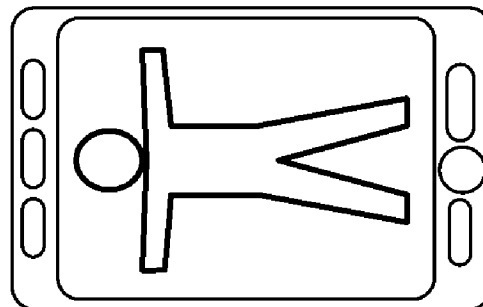

Figure 44C



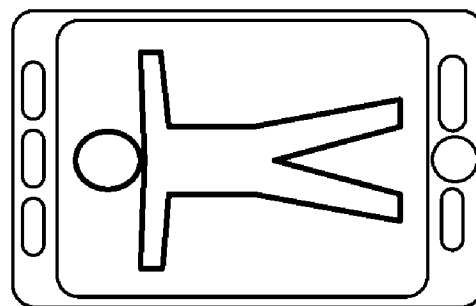
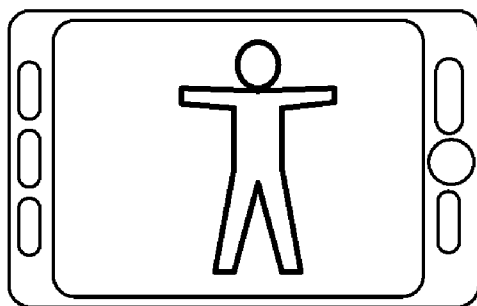
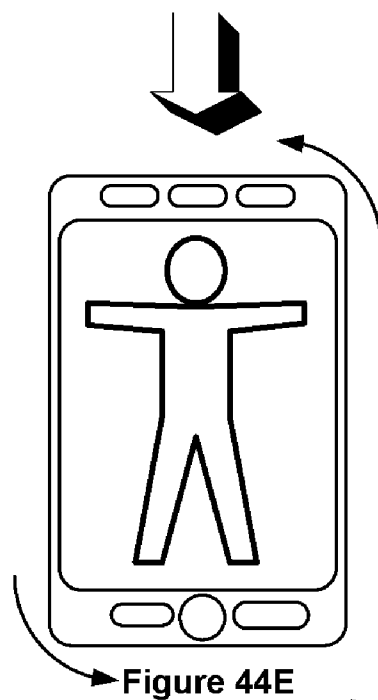
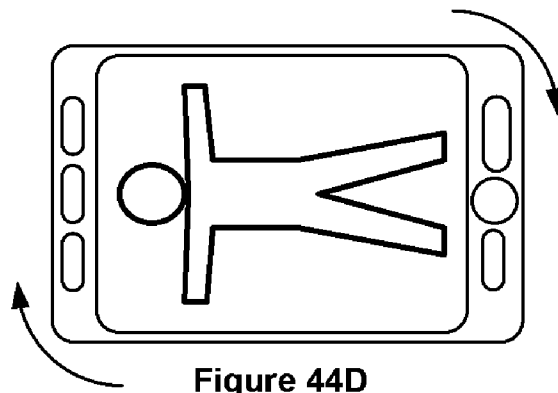

Figure 44F

Figure 44G

Figure 44H

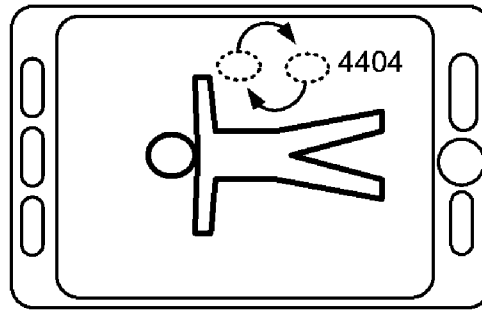

Figure 44I

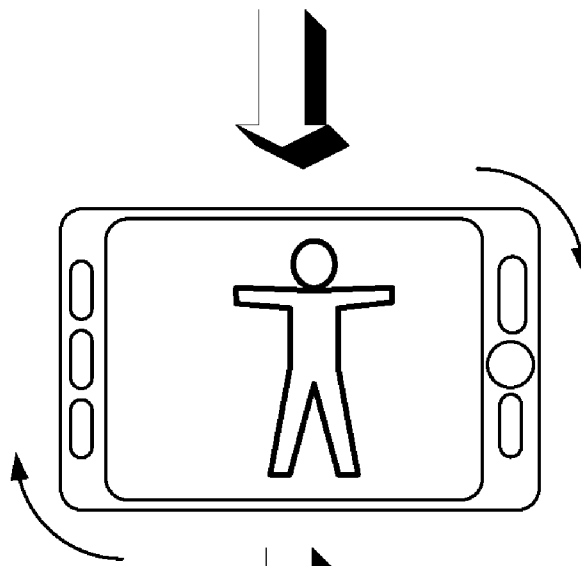
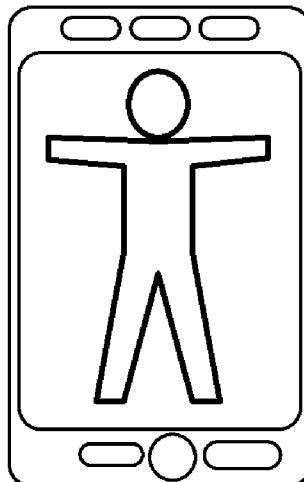

Figure 44J



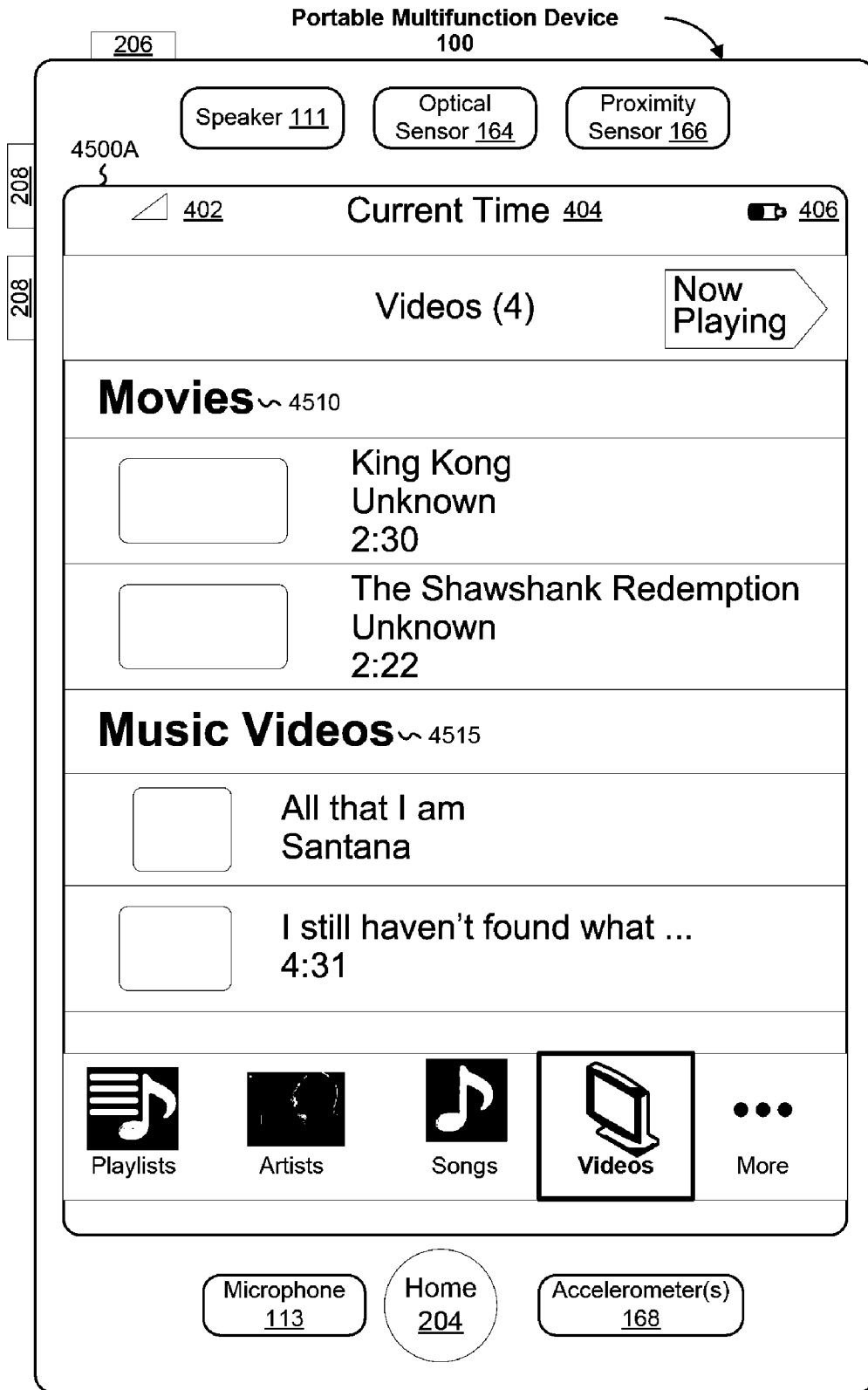

Figure 45A

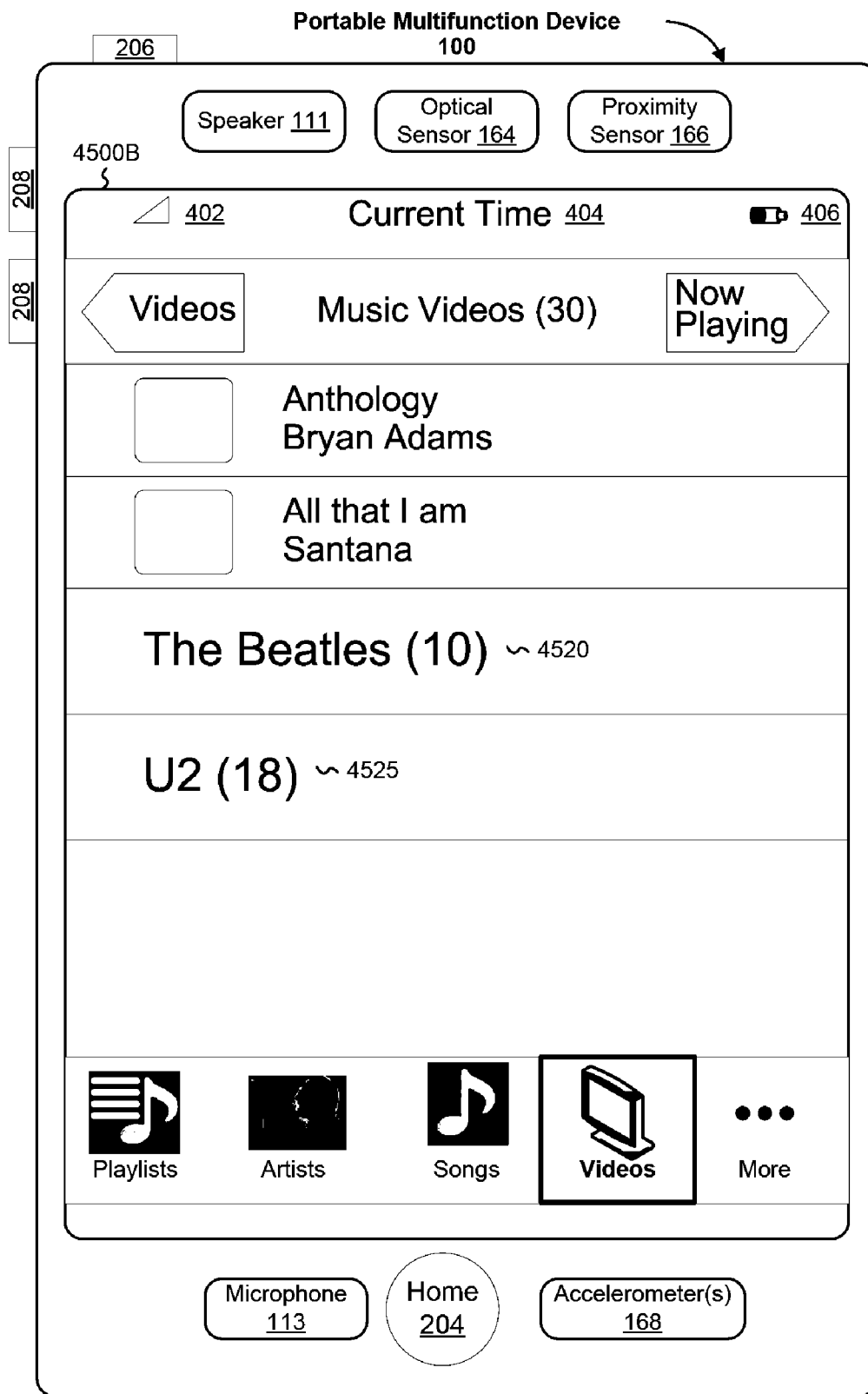

Figure 45B

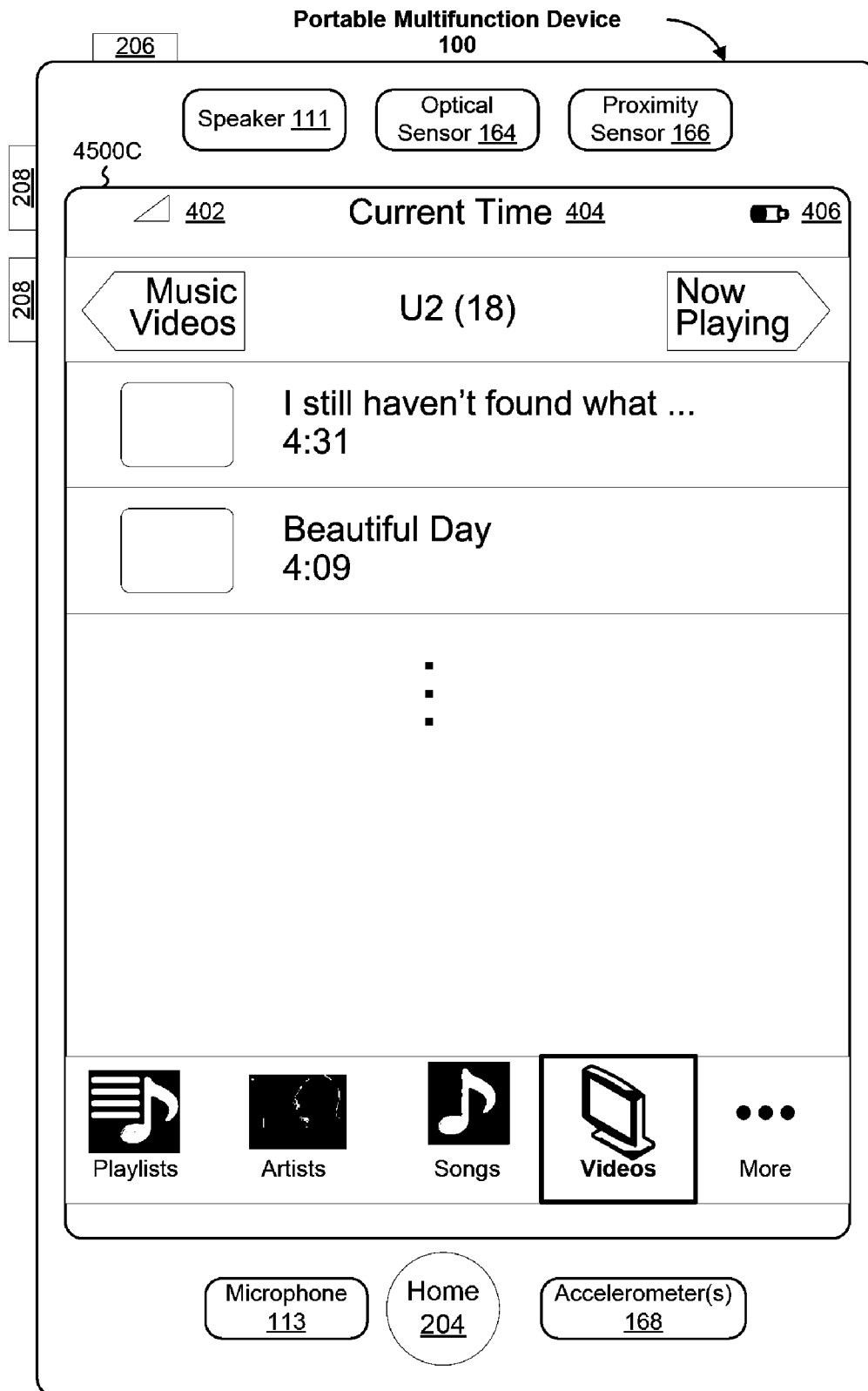

Figure 45C

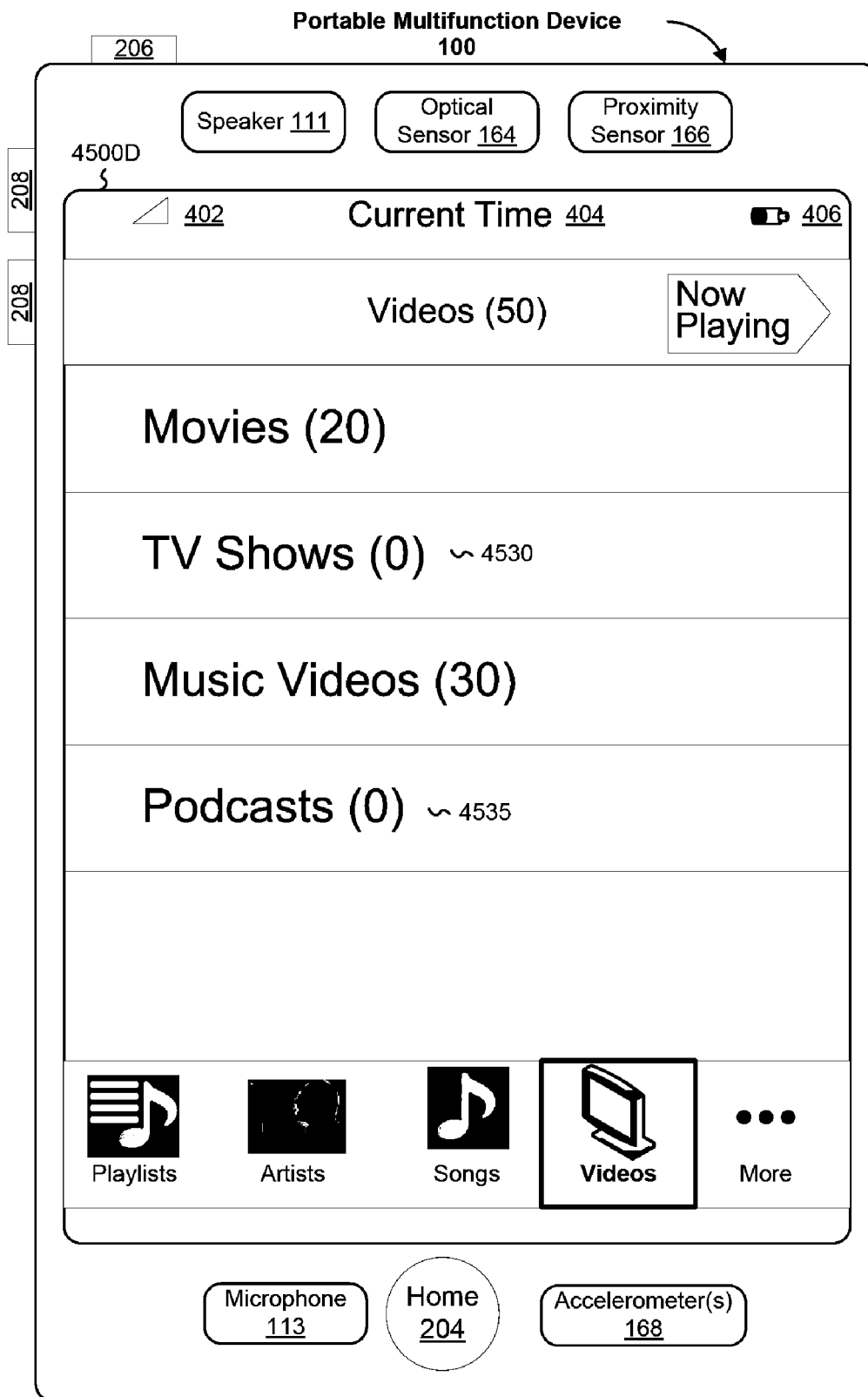

Figure 45D

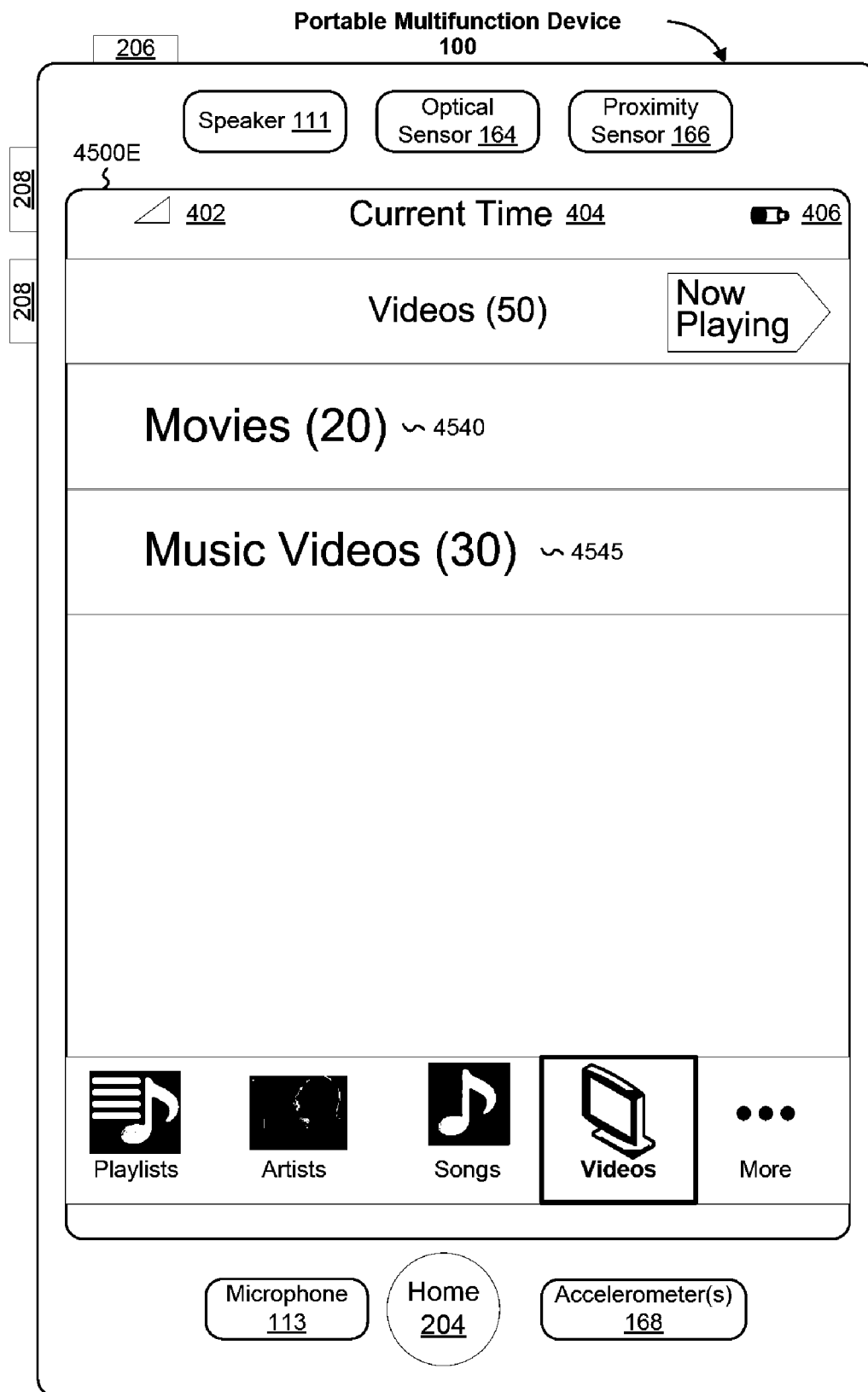

Figure 45E

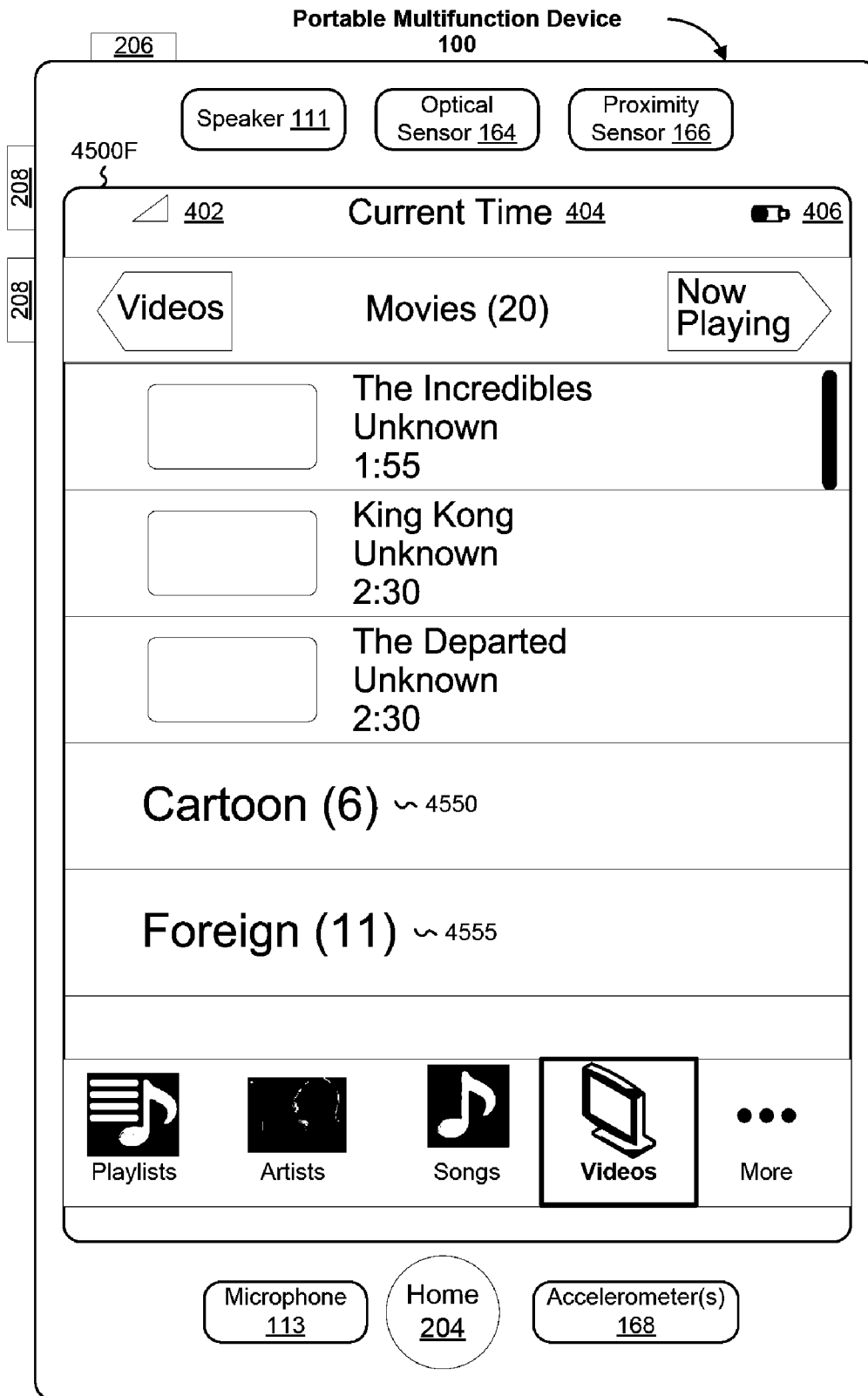

Figure 45F

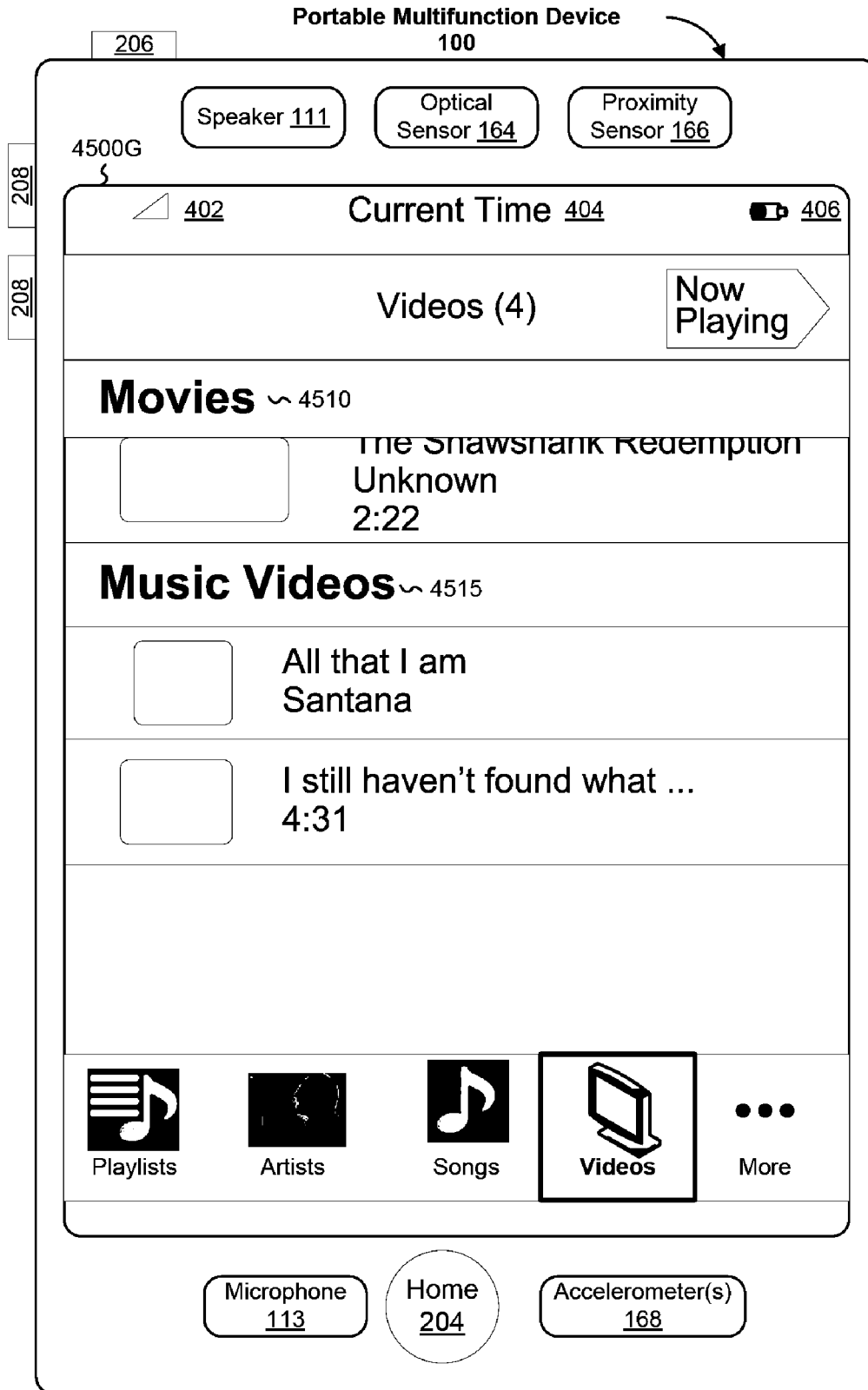

Figure 45G

Rap Album Template

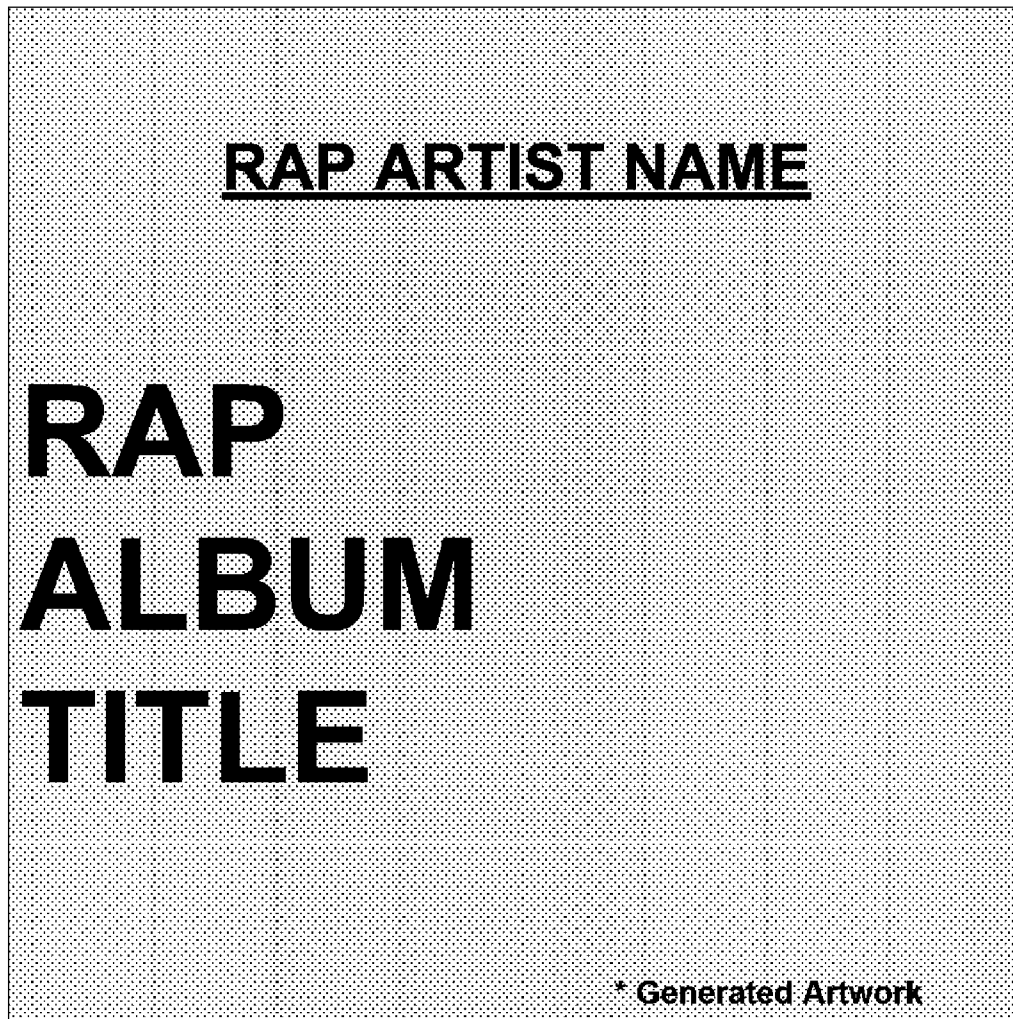

Figure 46A

Jazz Album Template

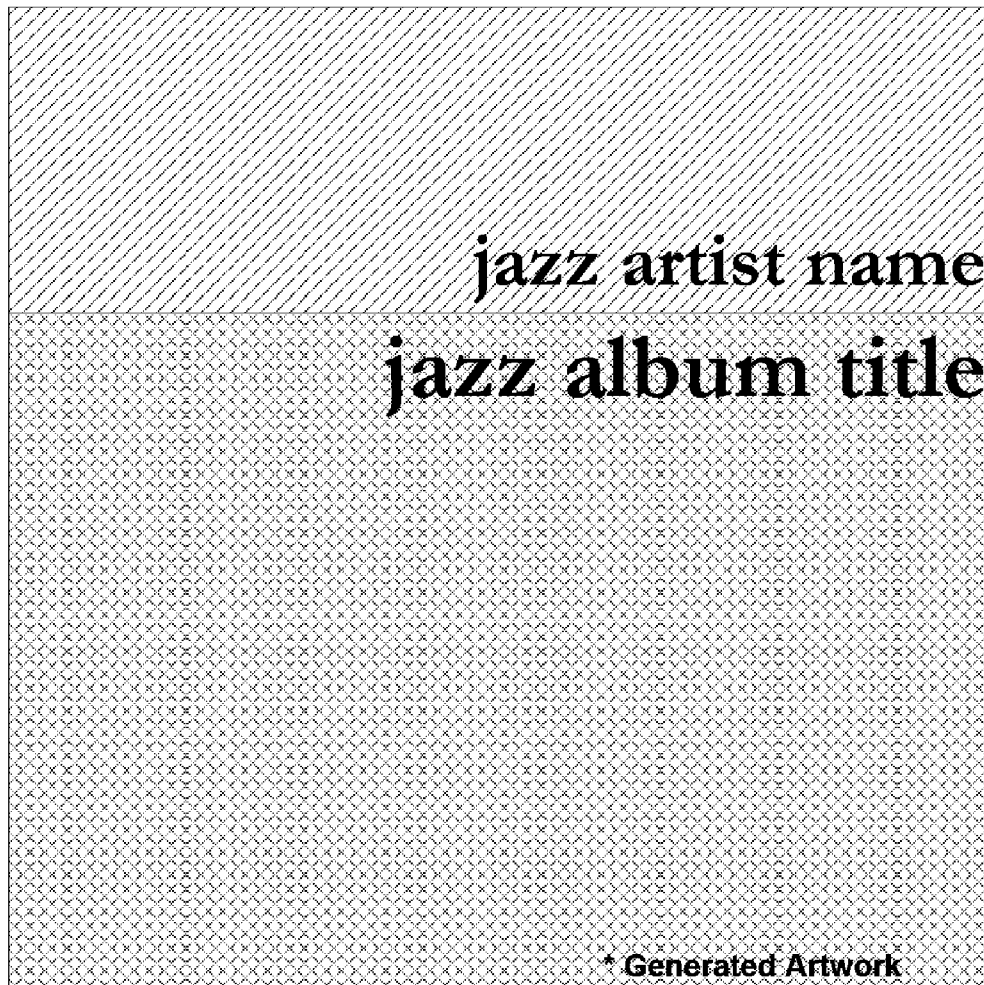

Figure 46B

Electronica Album Template

<p>ELECTRONICA ARTIST NAME</p>
<p>Electronica Album Title</p>

Figure 46C

Figure 47A

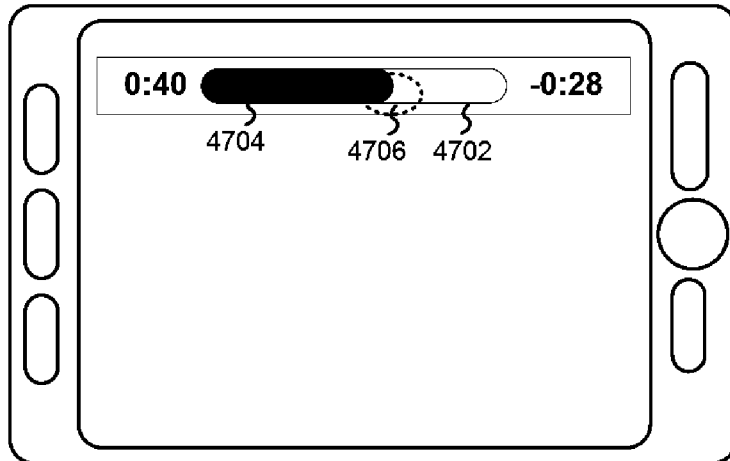
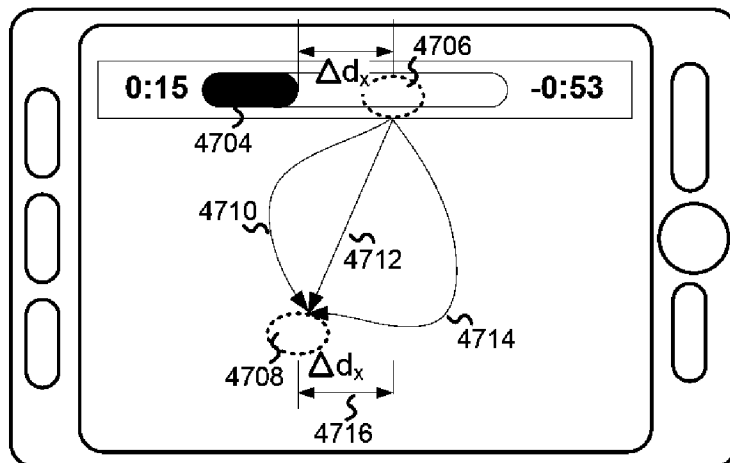

Figure 47B



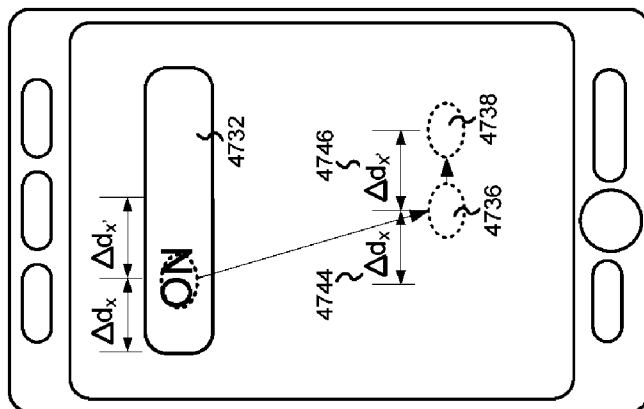

Figure 47E

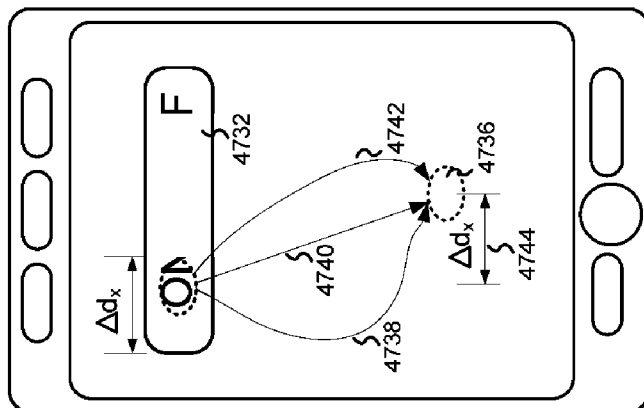

Figure 47D

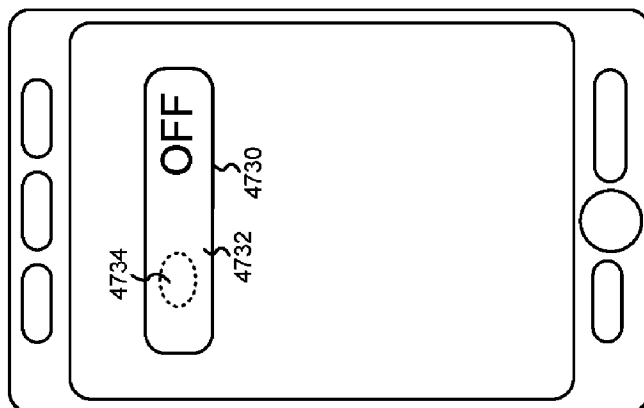

Figure 47C

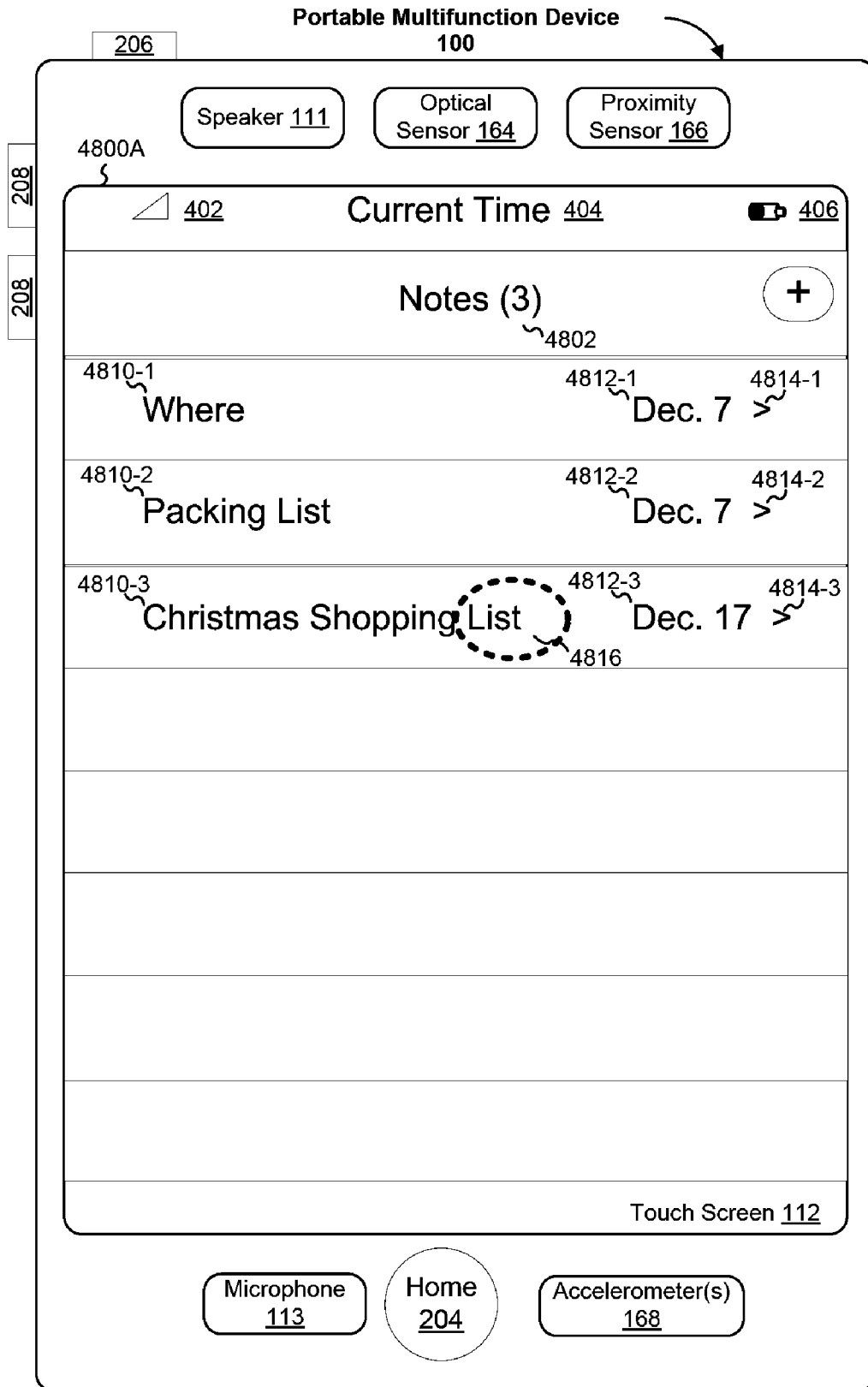

Figure 48A



Figure 48B

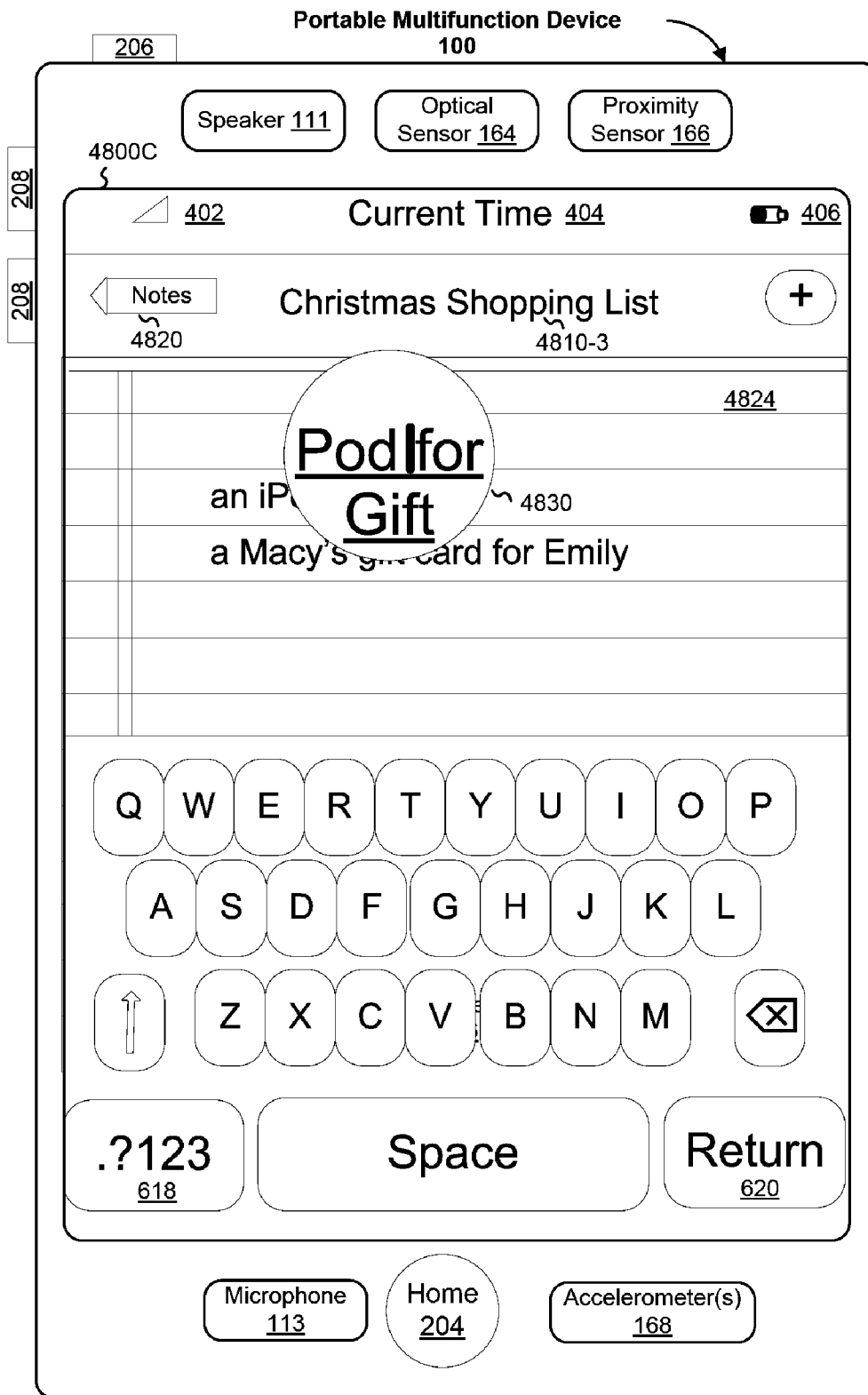

Figure 48C

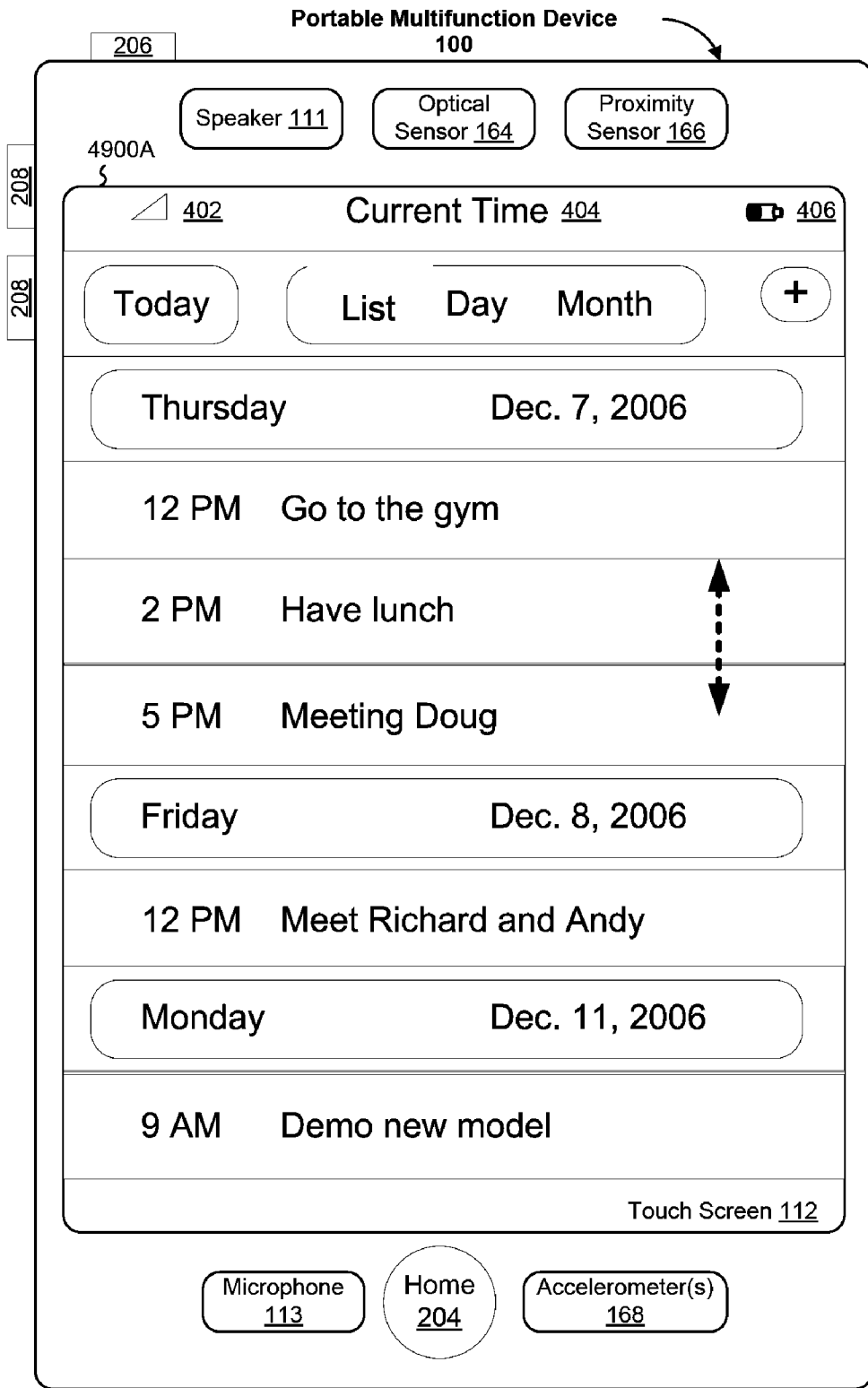

Figure 49A

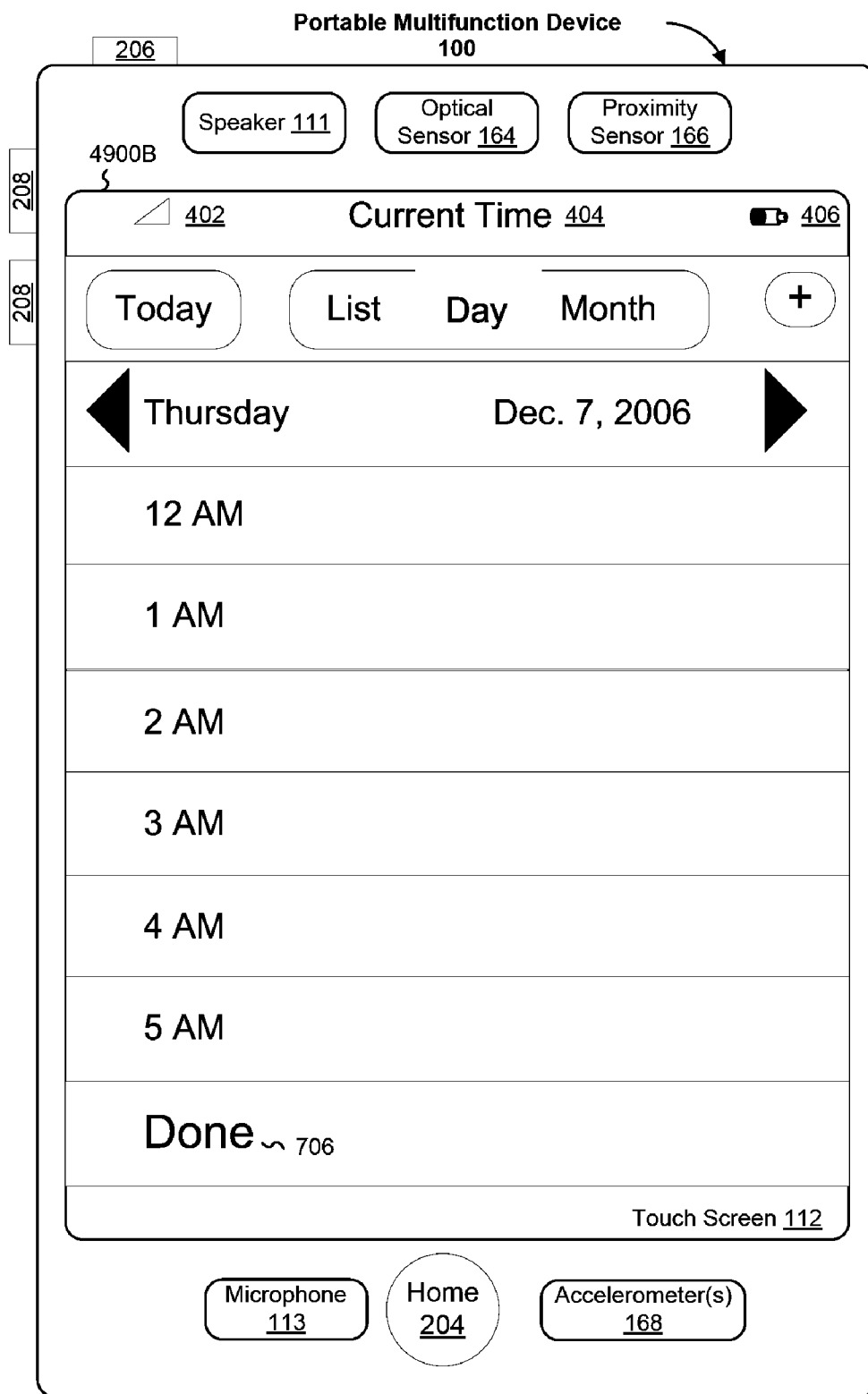

Figure 49B

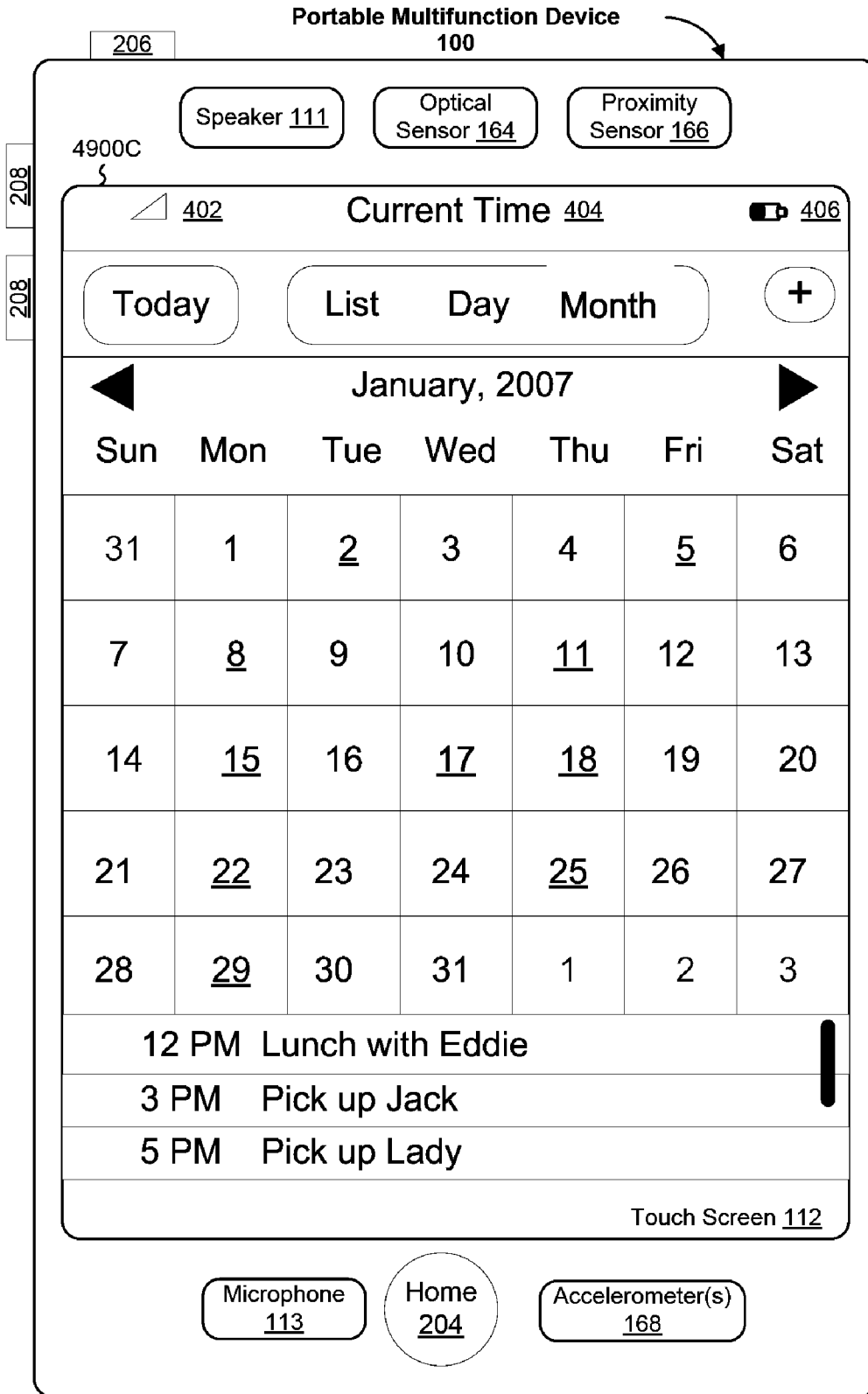

Figure 49C

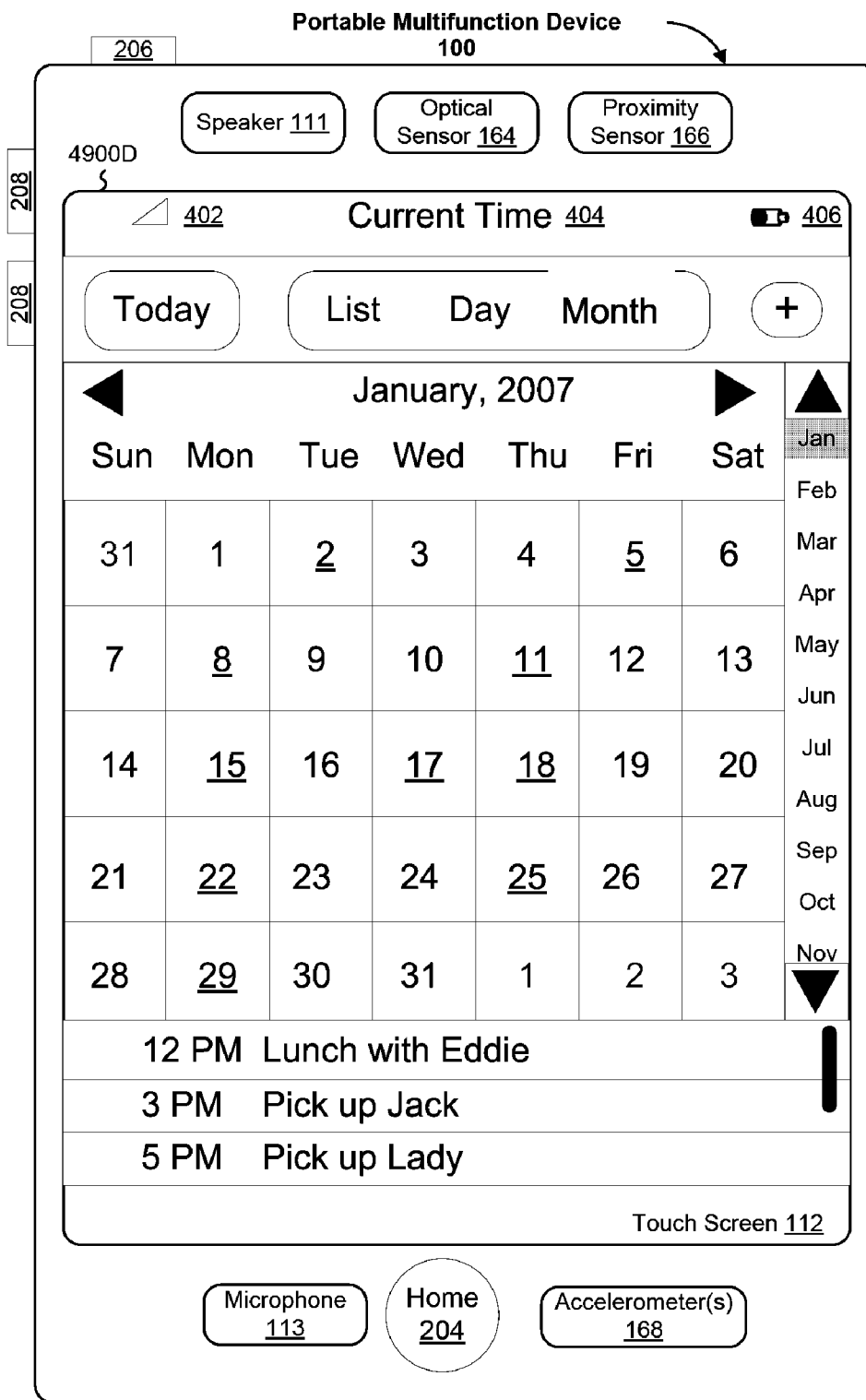

Figure 49D

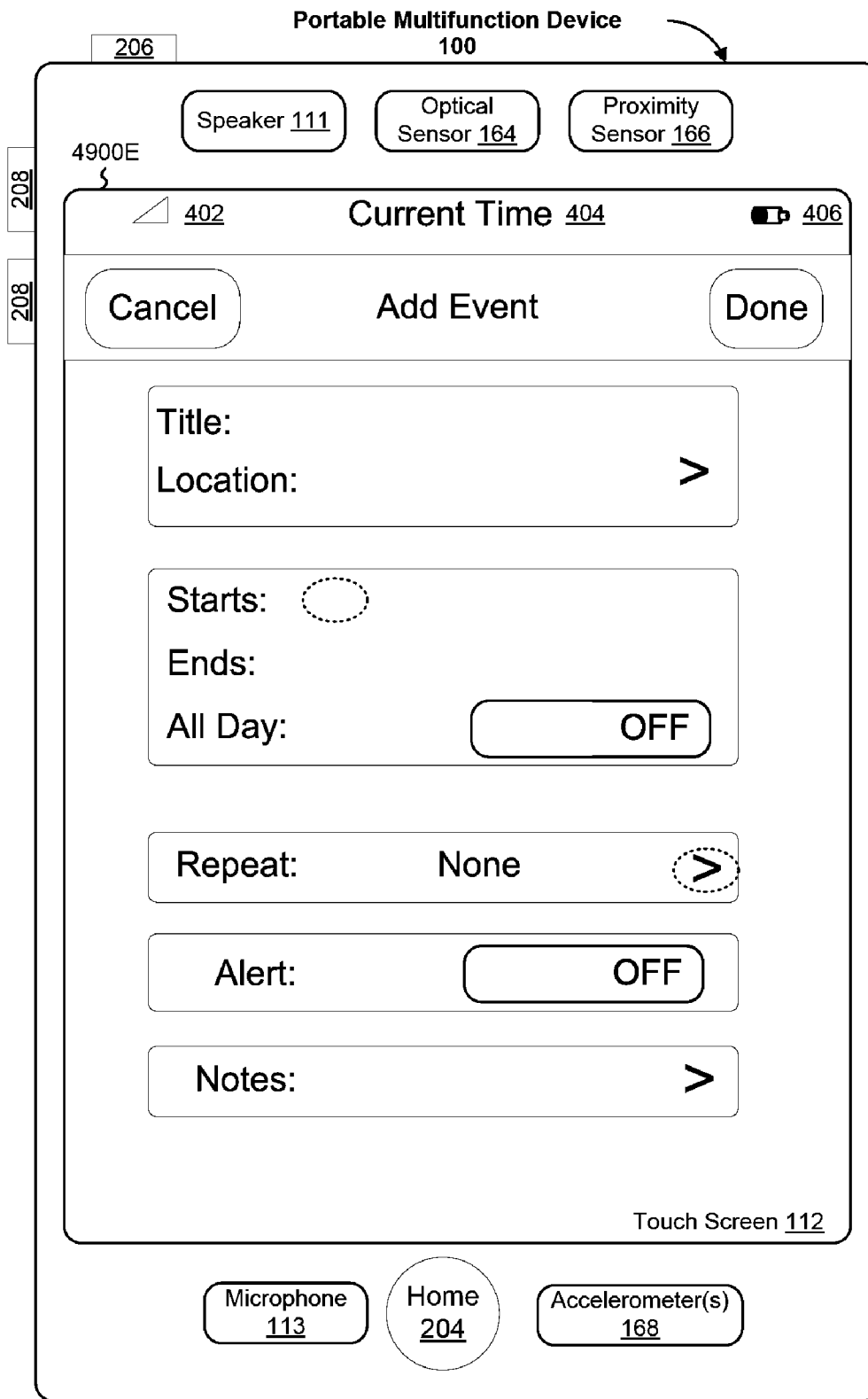

Figure 49E

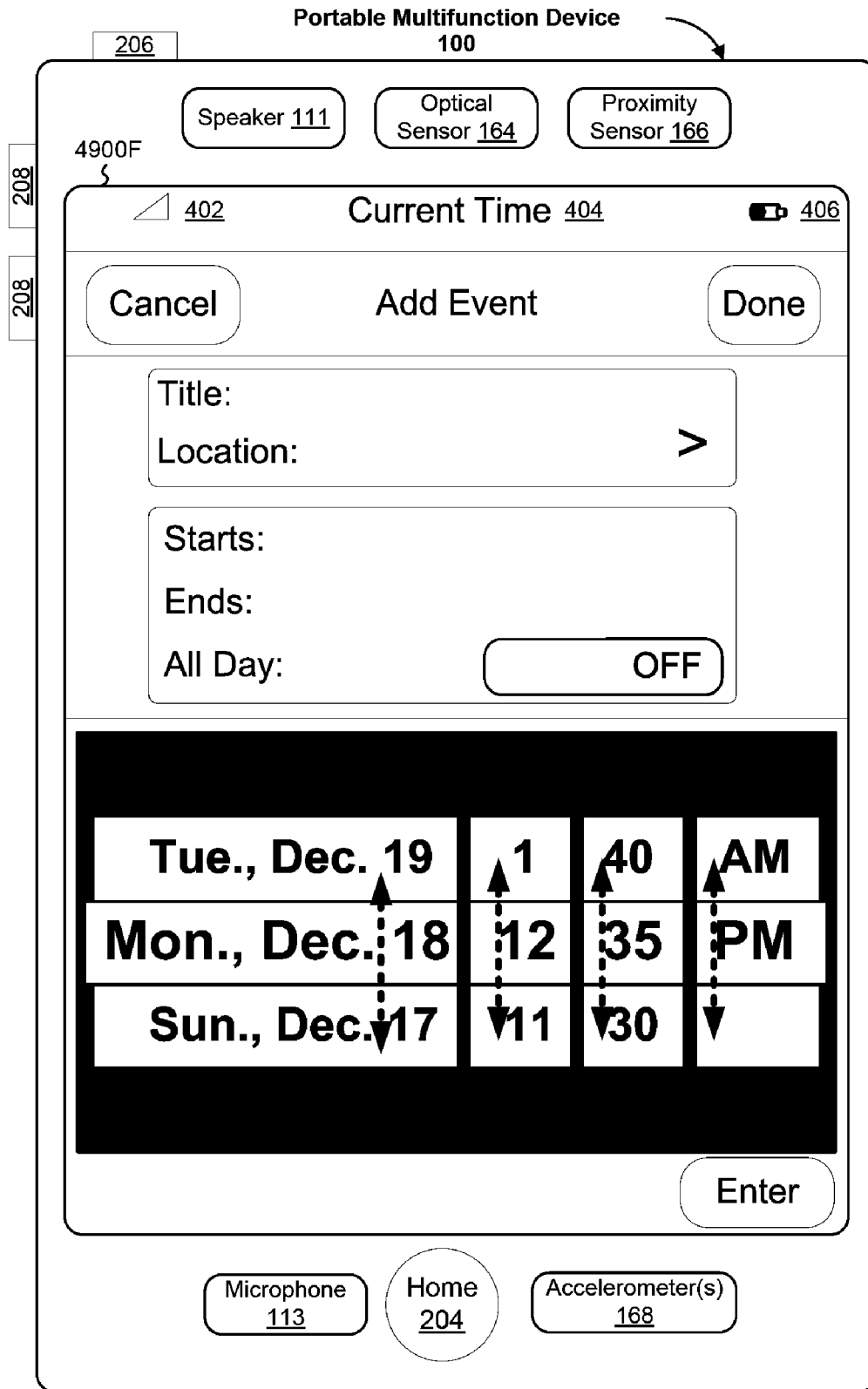

Figure 49F



Figure 49G

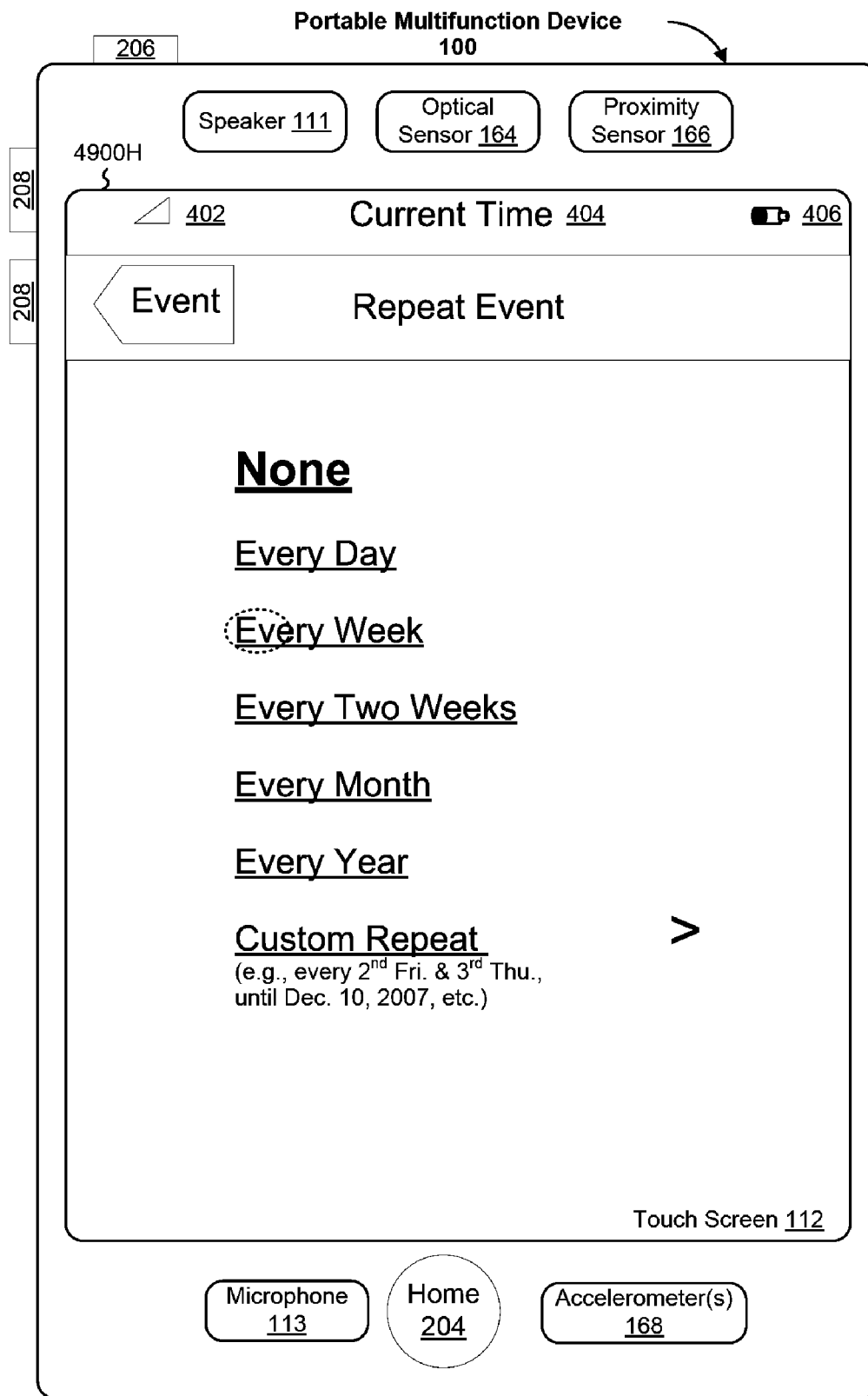

Figure 49H

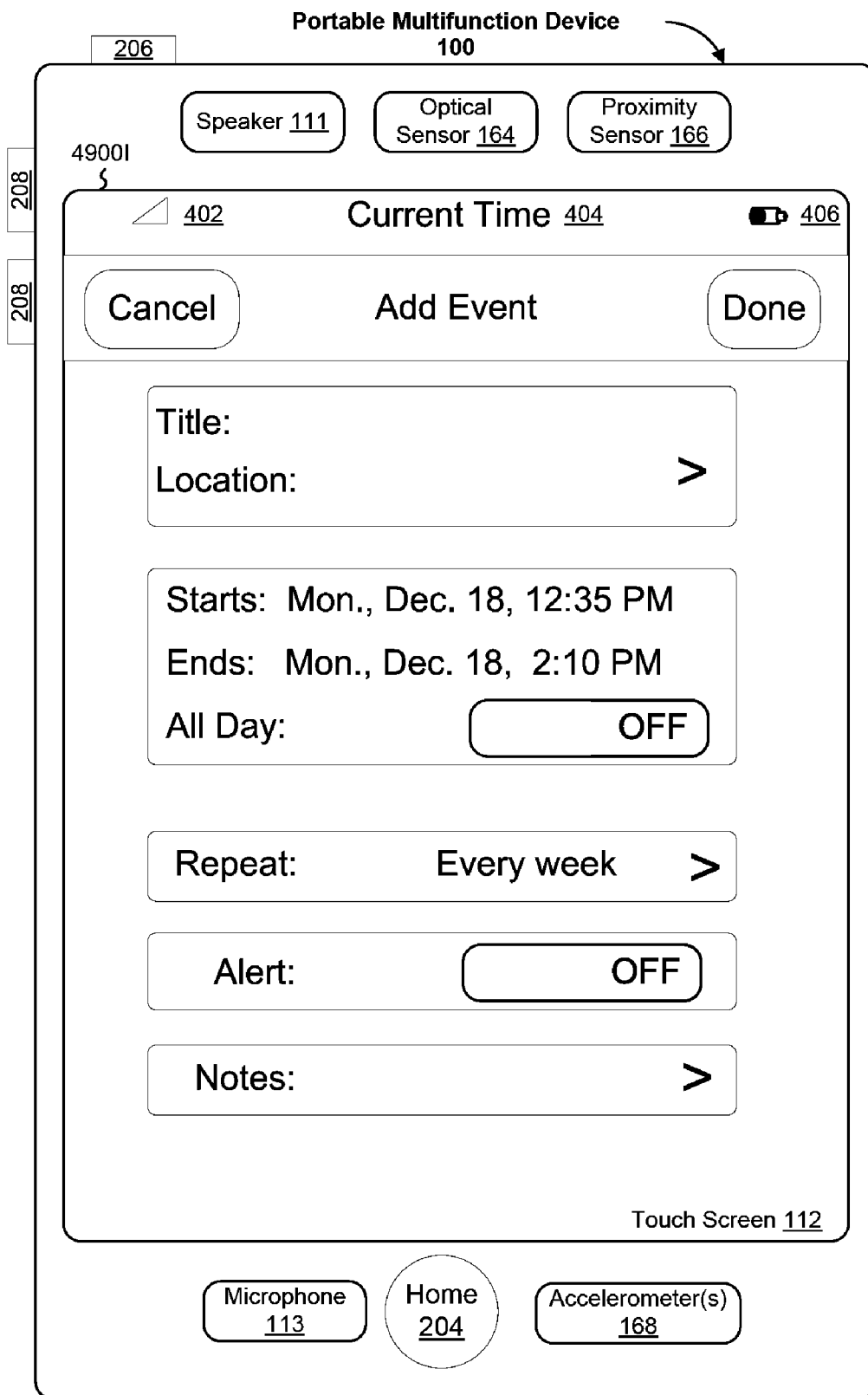

Figure 49I

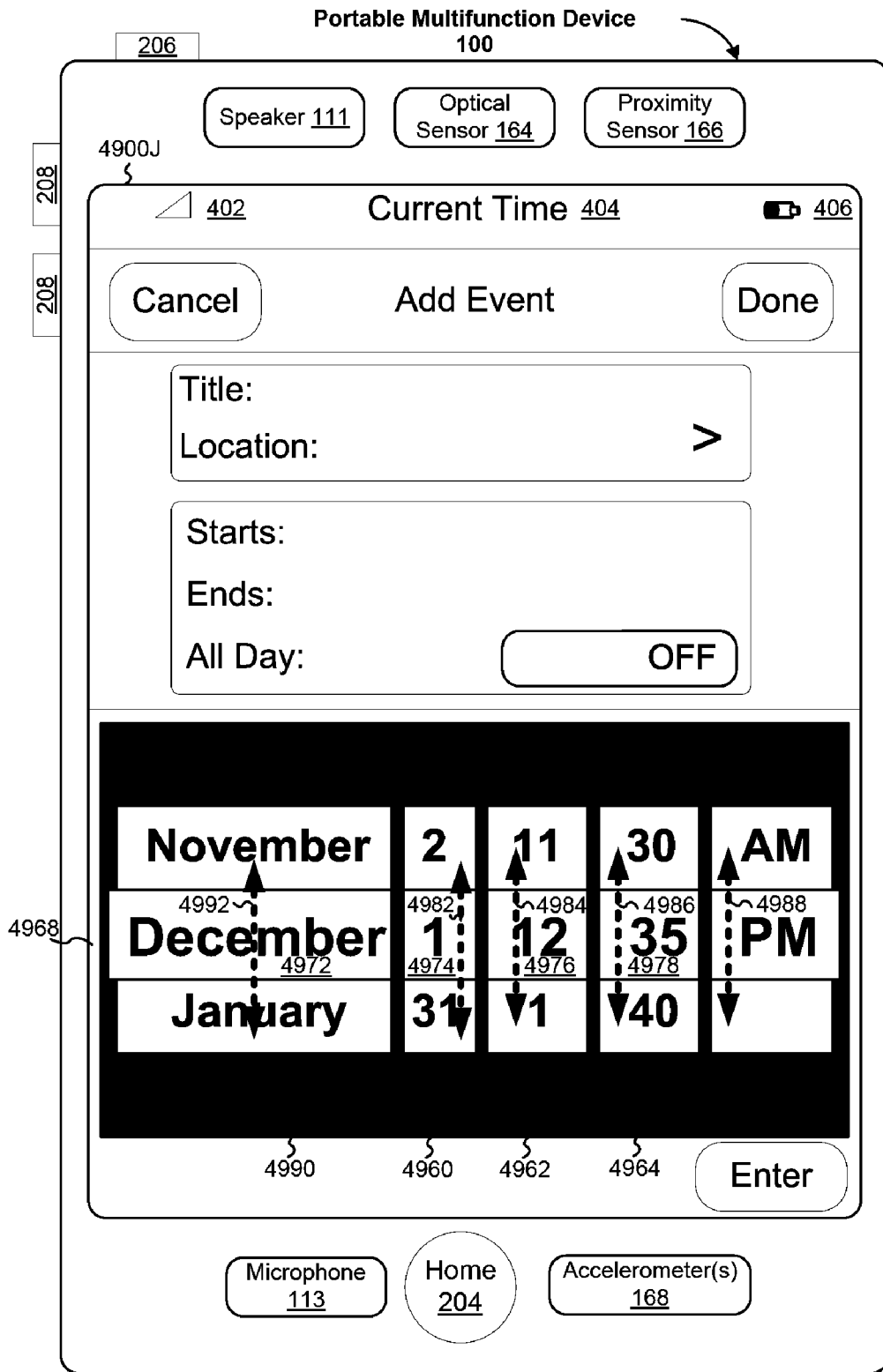

Figure 49J



Figure 49K

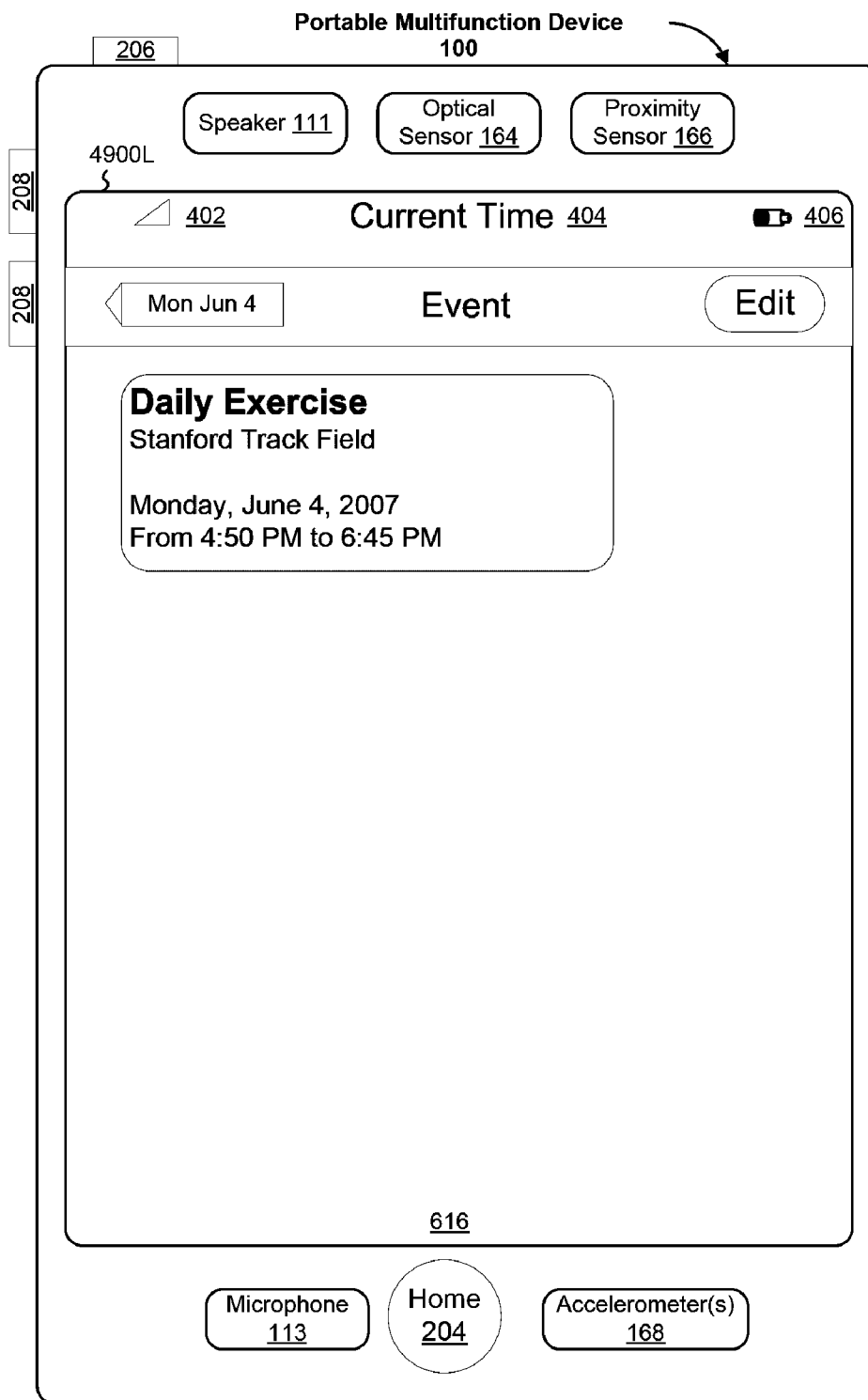

Figure 49L

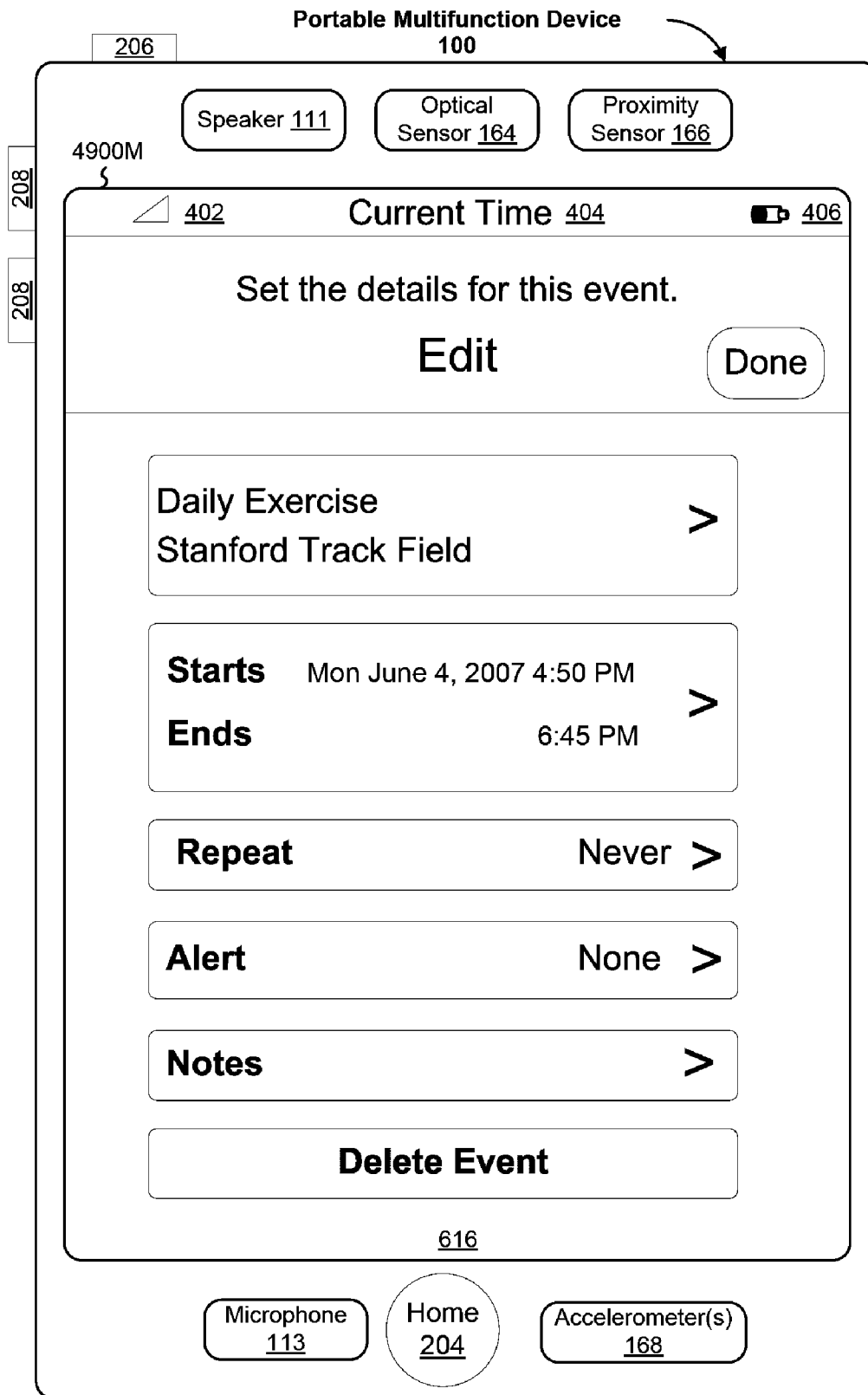

Figure 49M

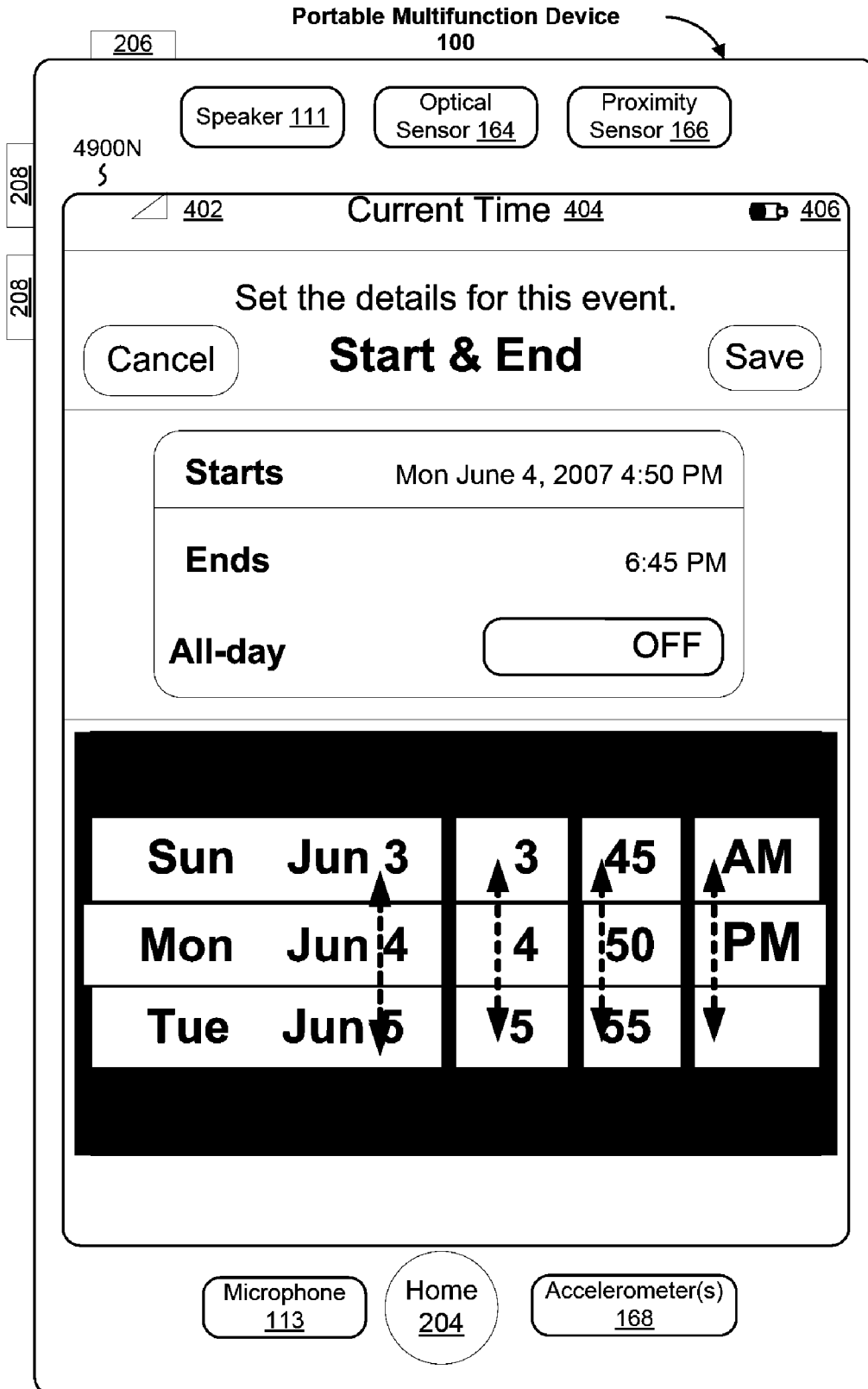

Figure 49N

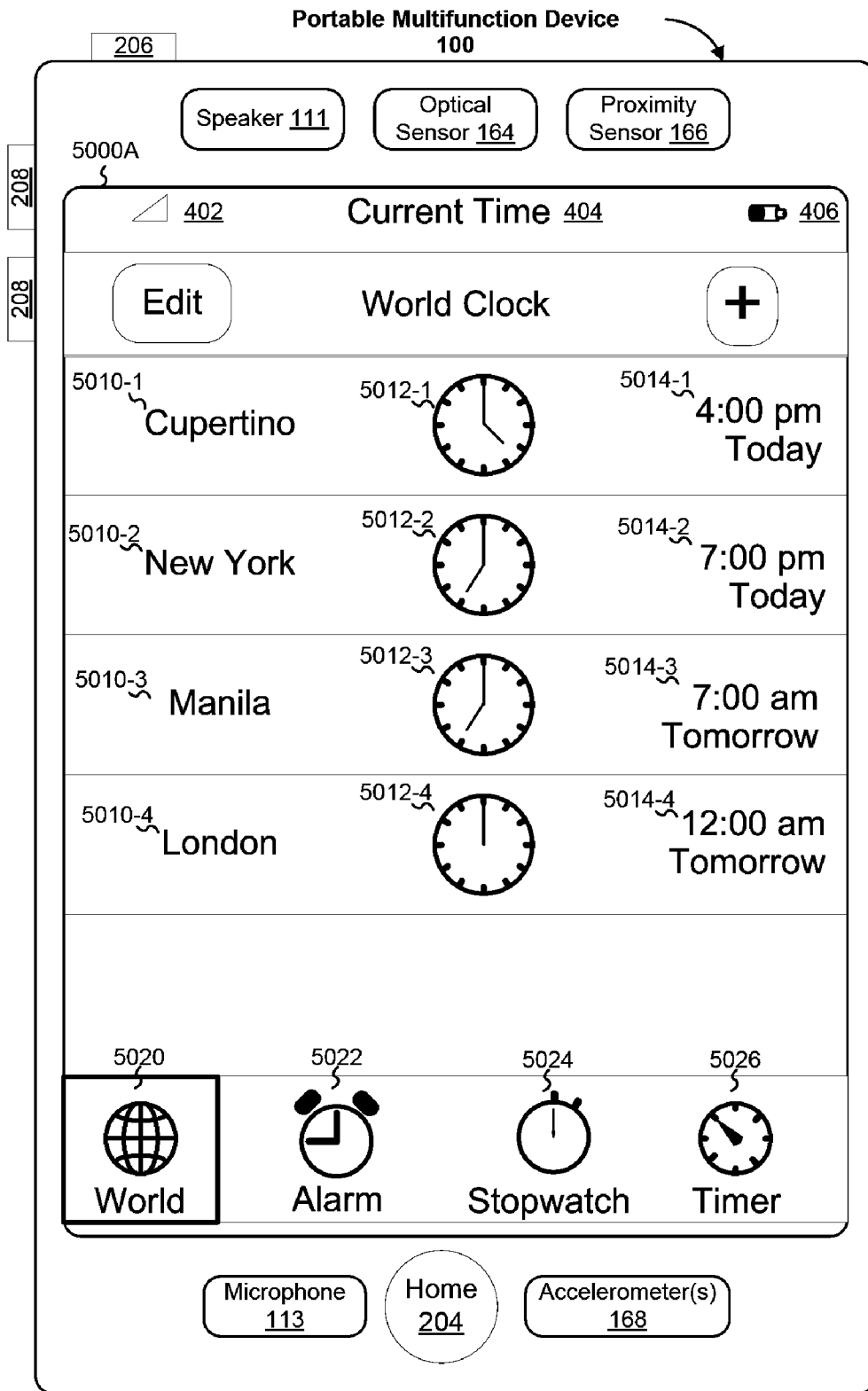

Figure 50A

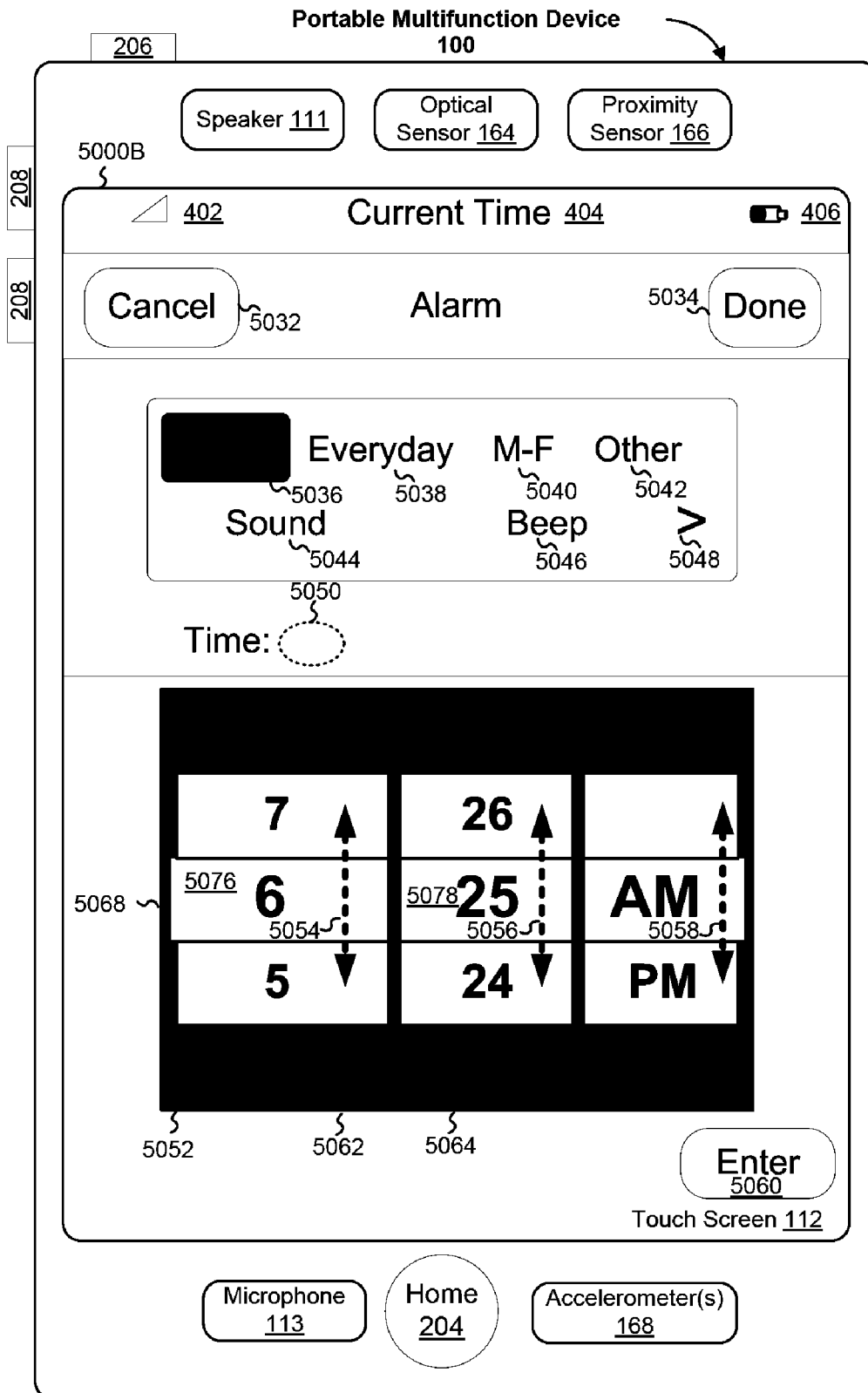

Figure 50B

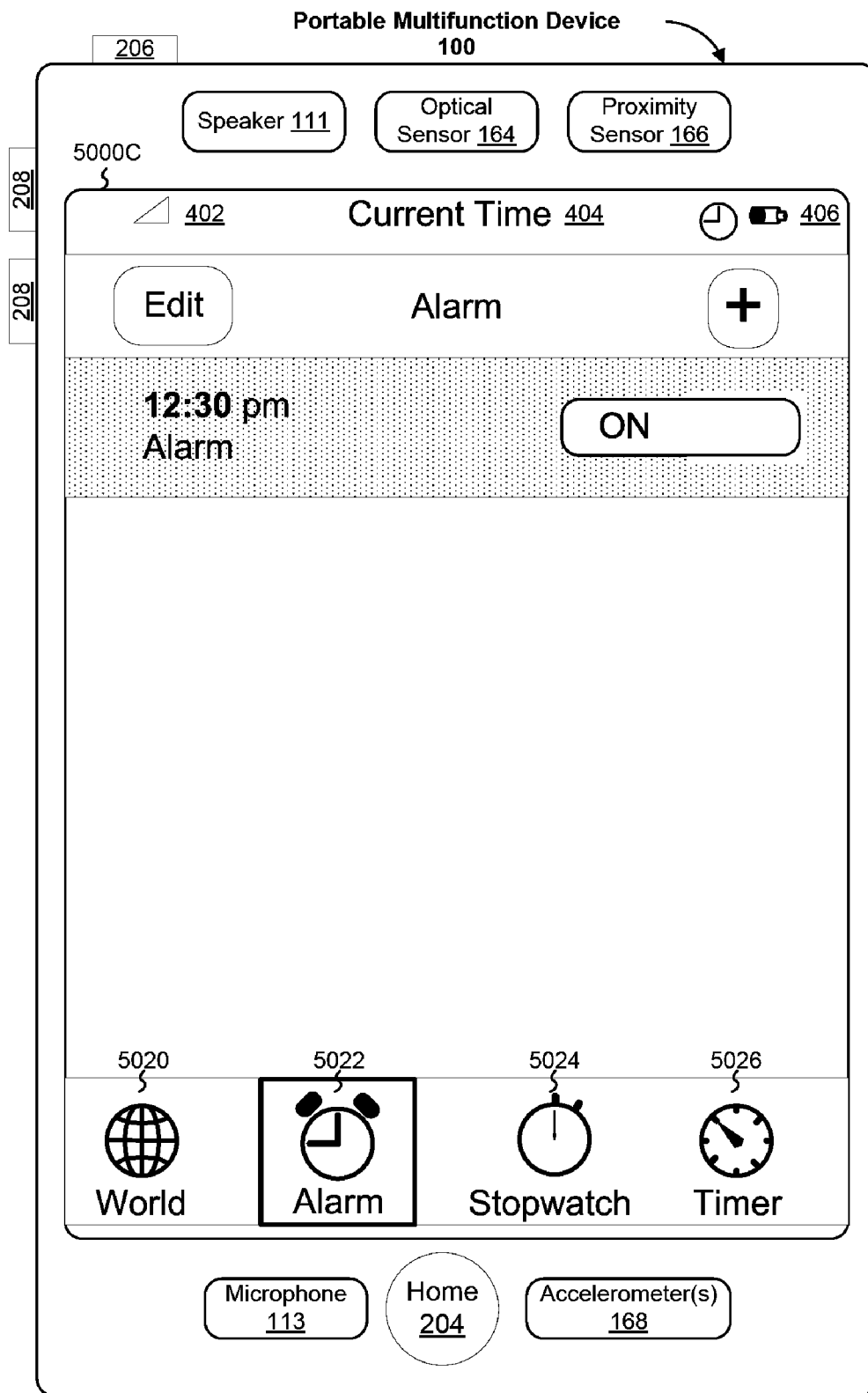

Figure 50C

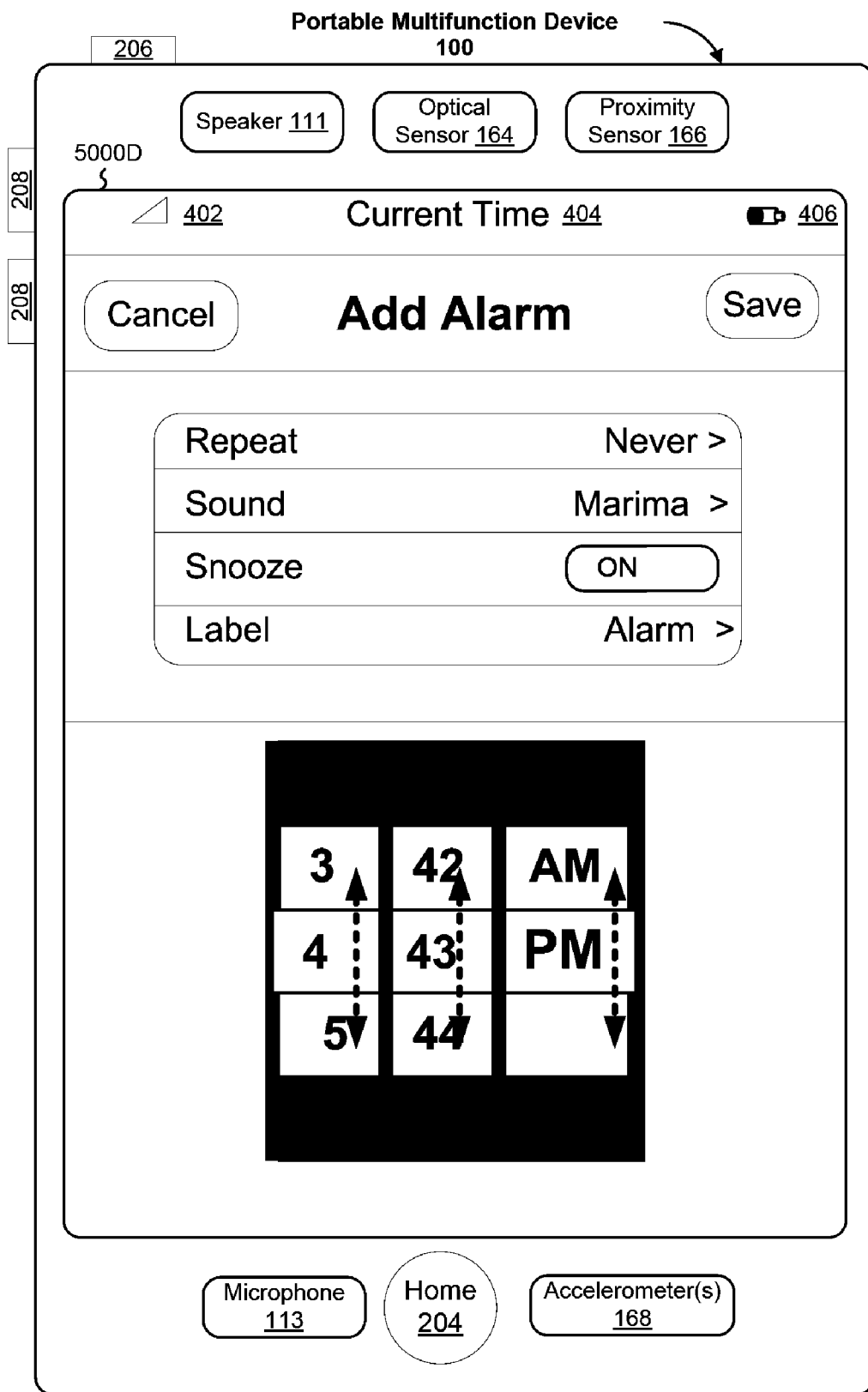

Figure 50D

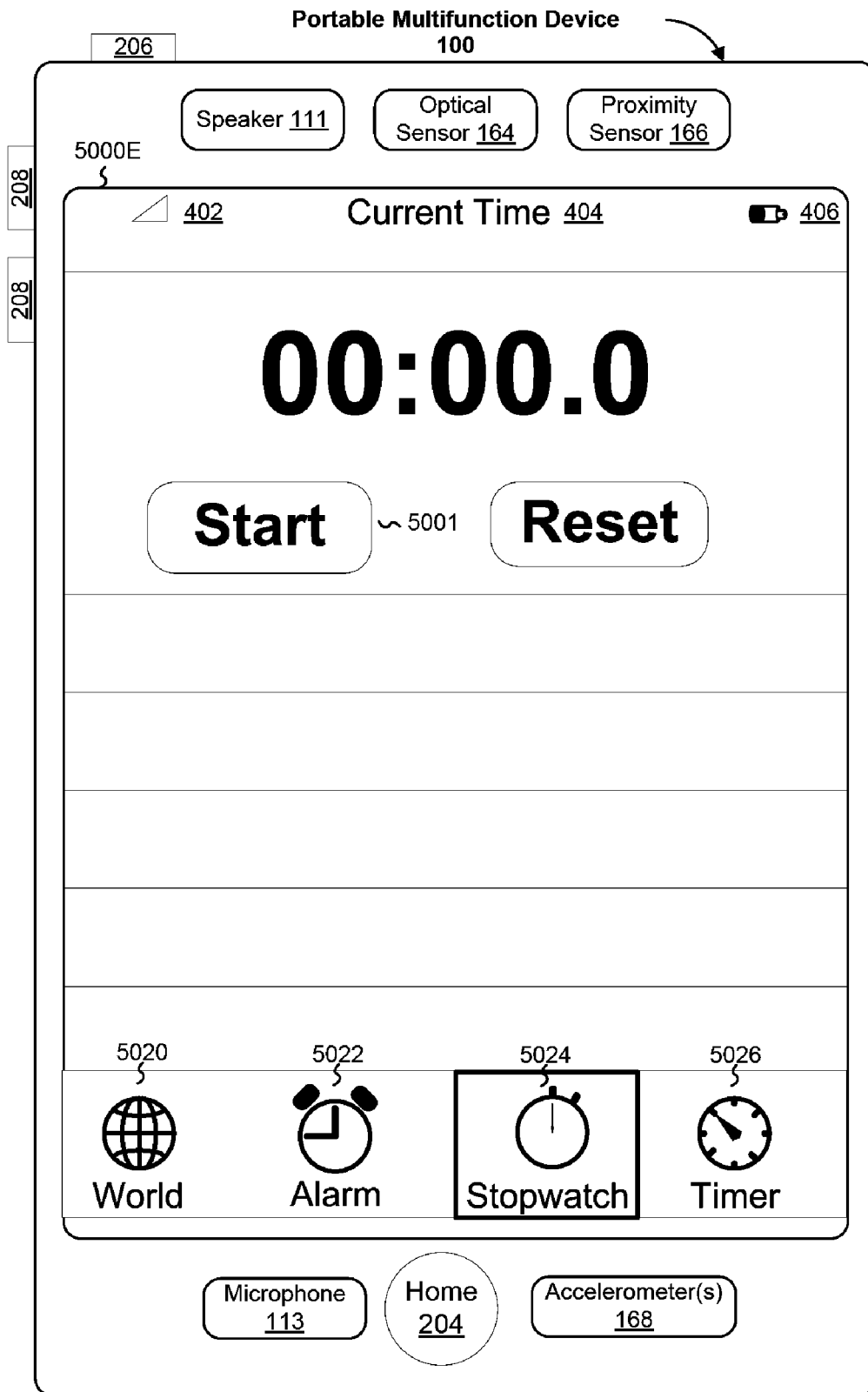

Figure 50E

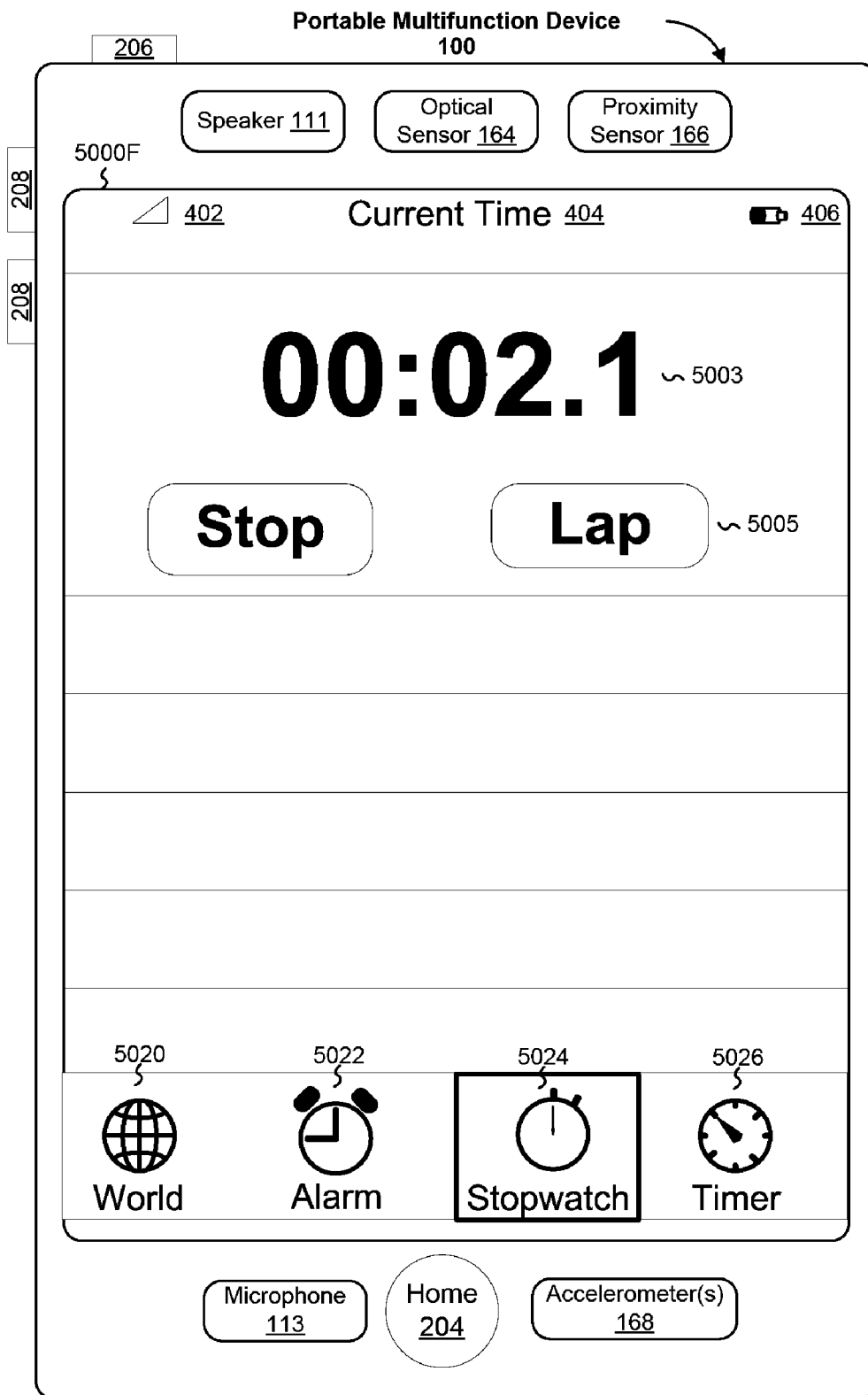

Figure 50F

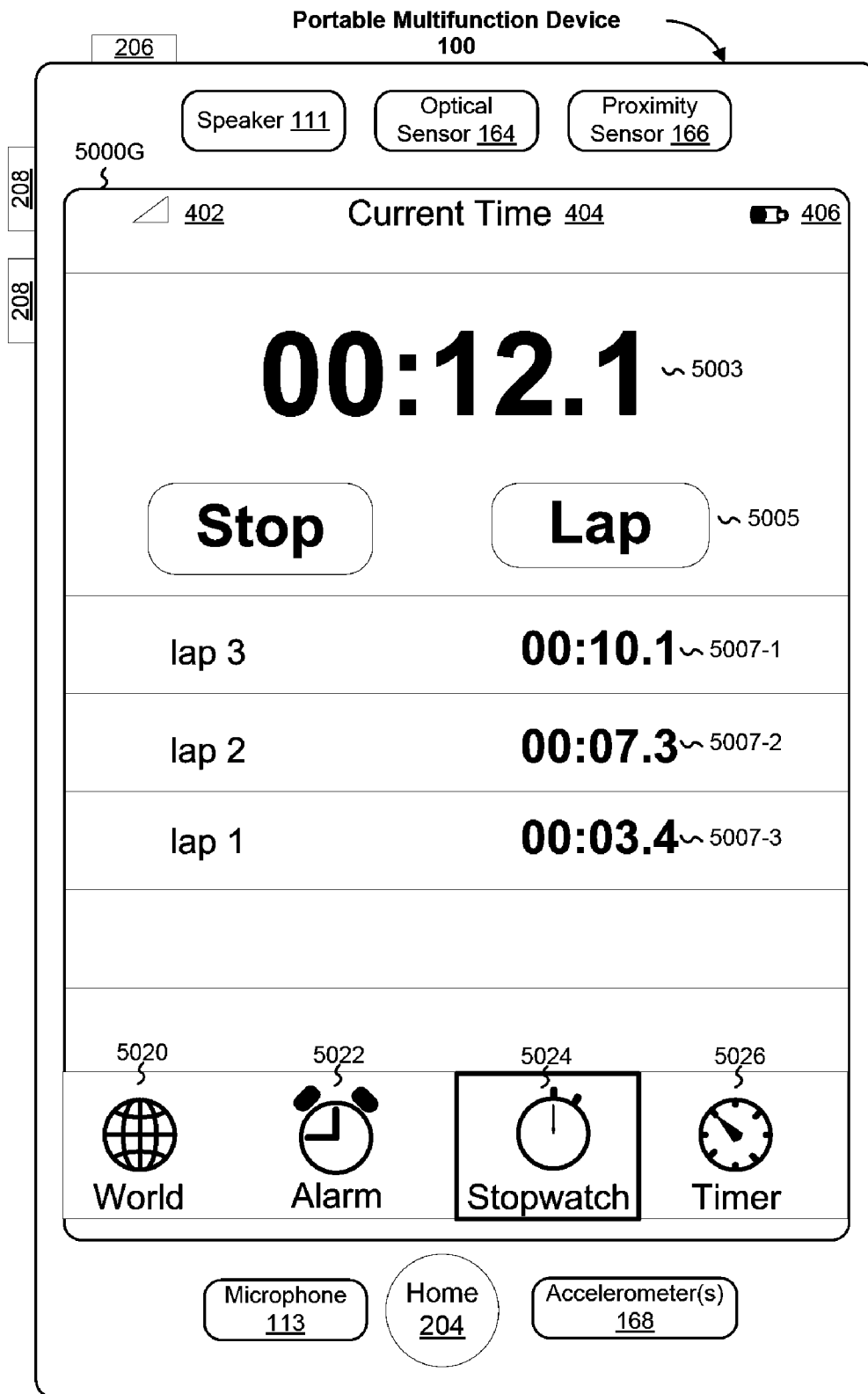

Figure 50G

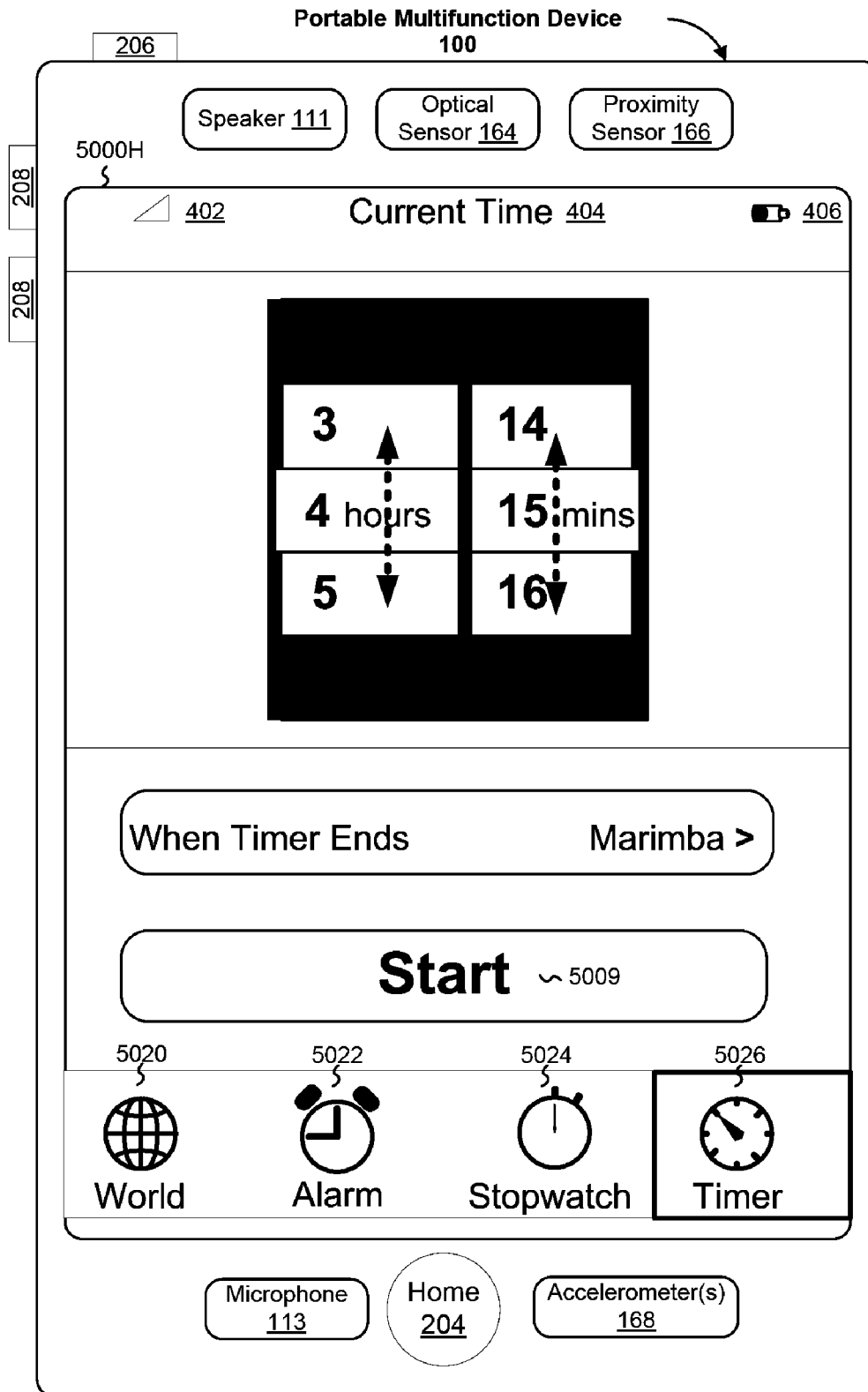

Figure 50H

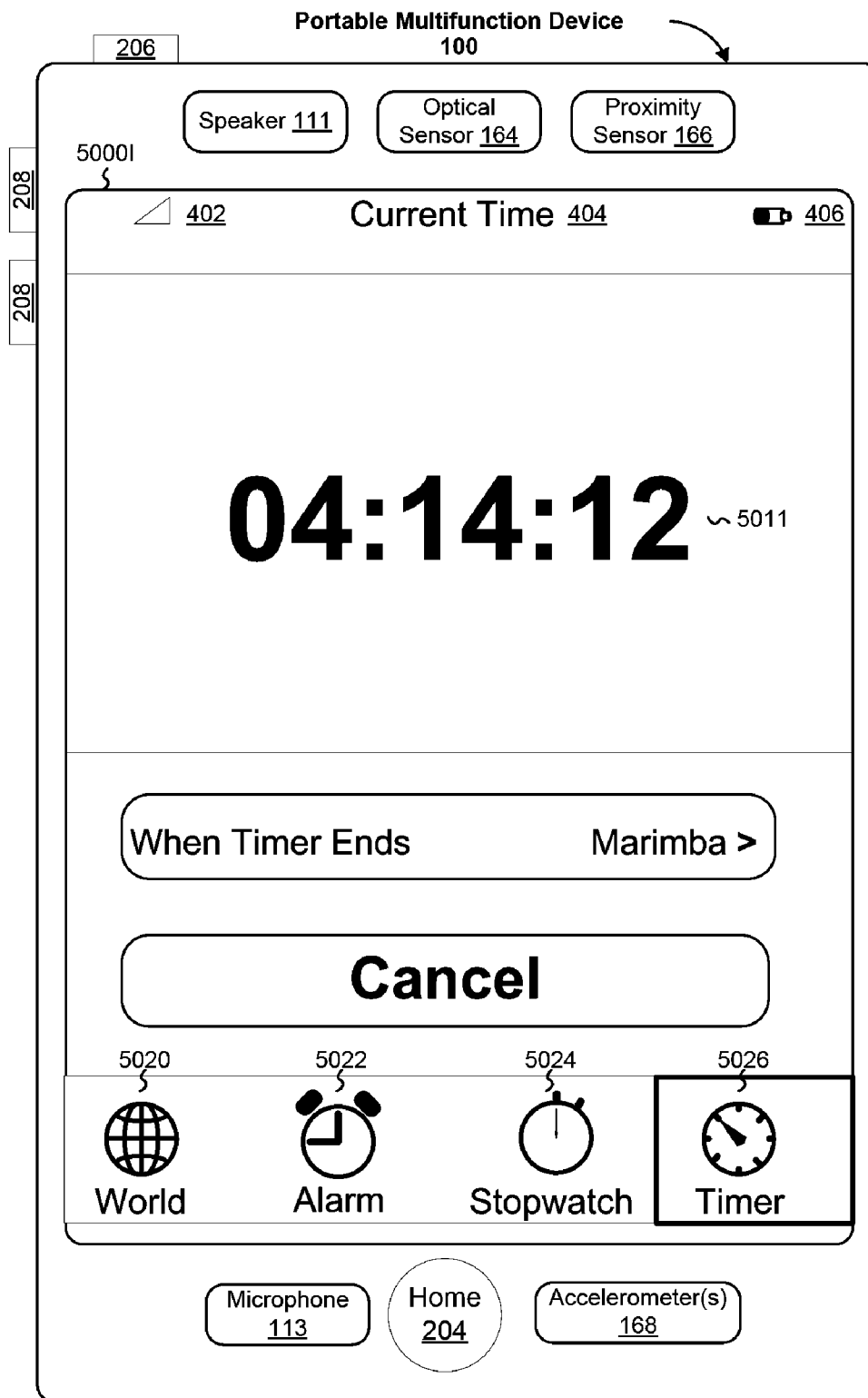

Figure 50I

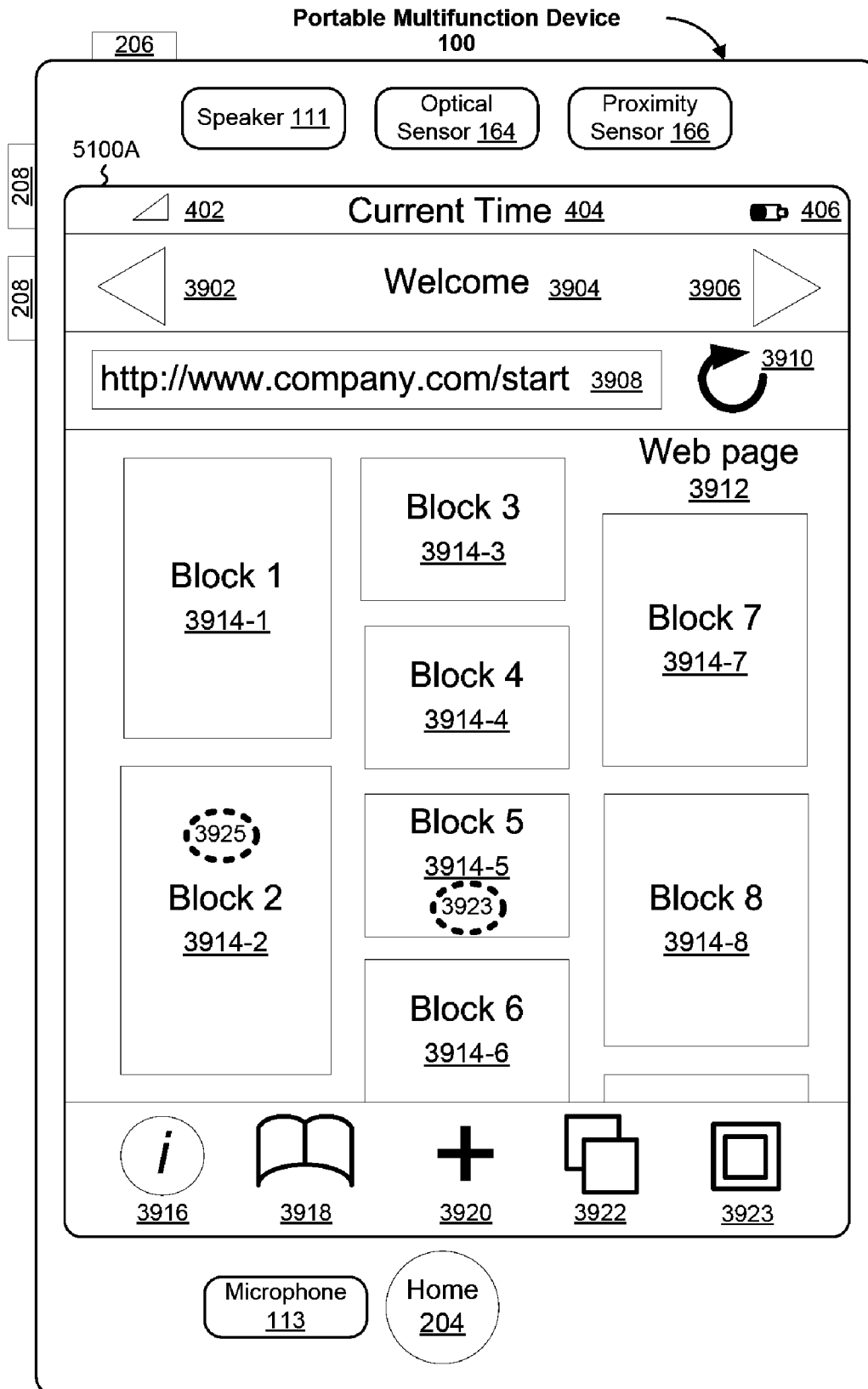

Figure 51A

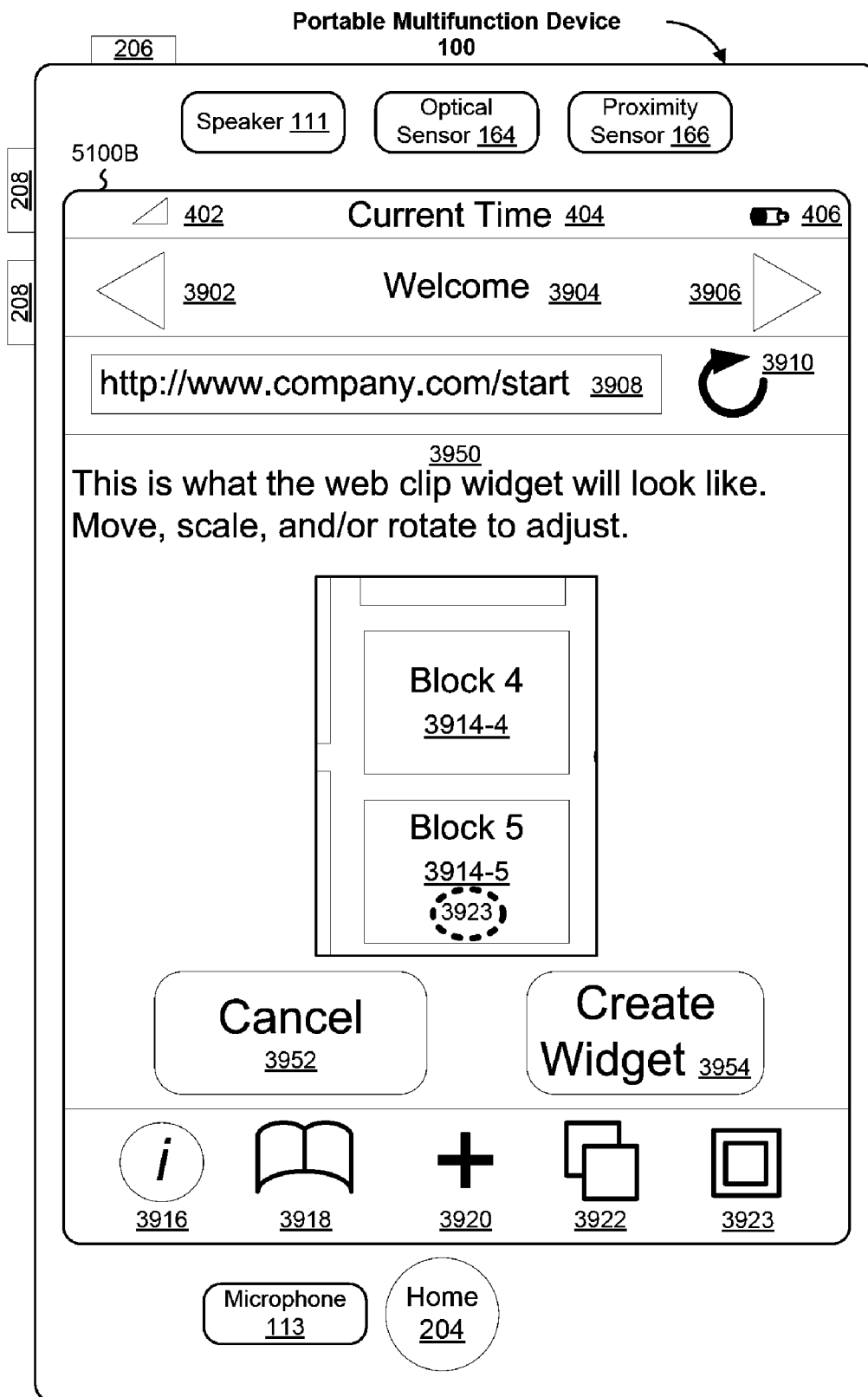

Figure 51B

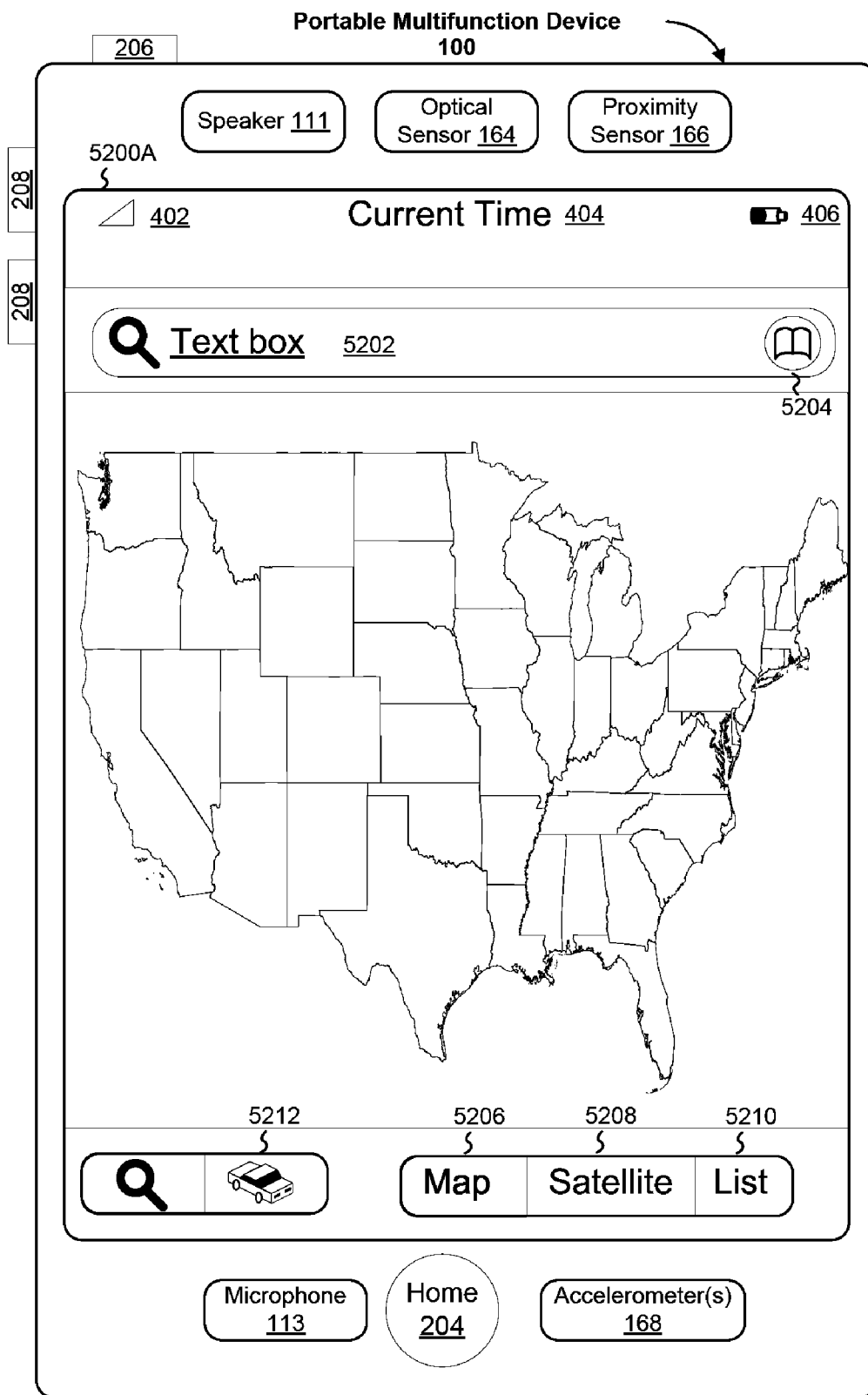

Figure 52A

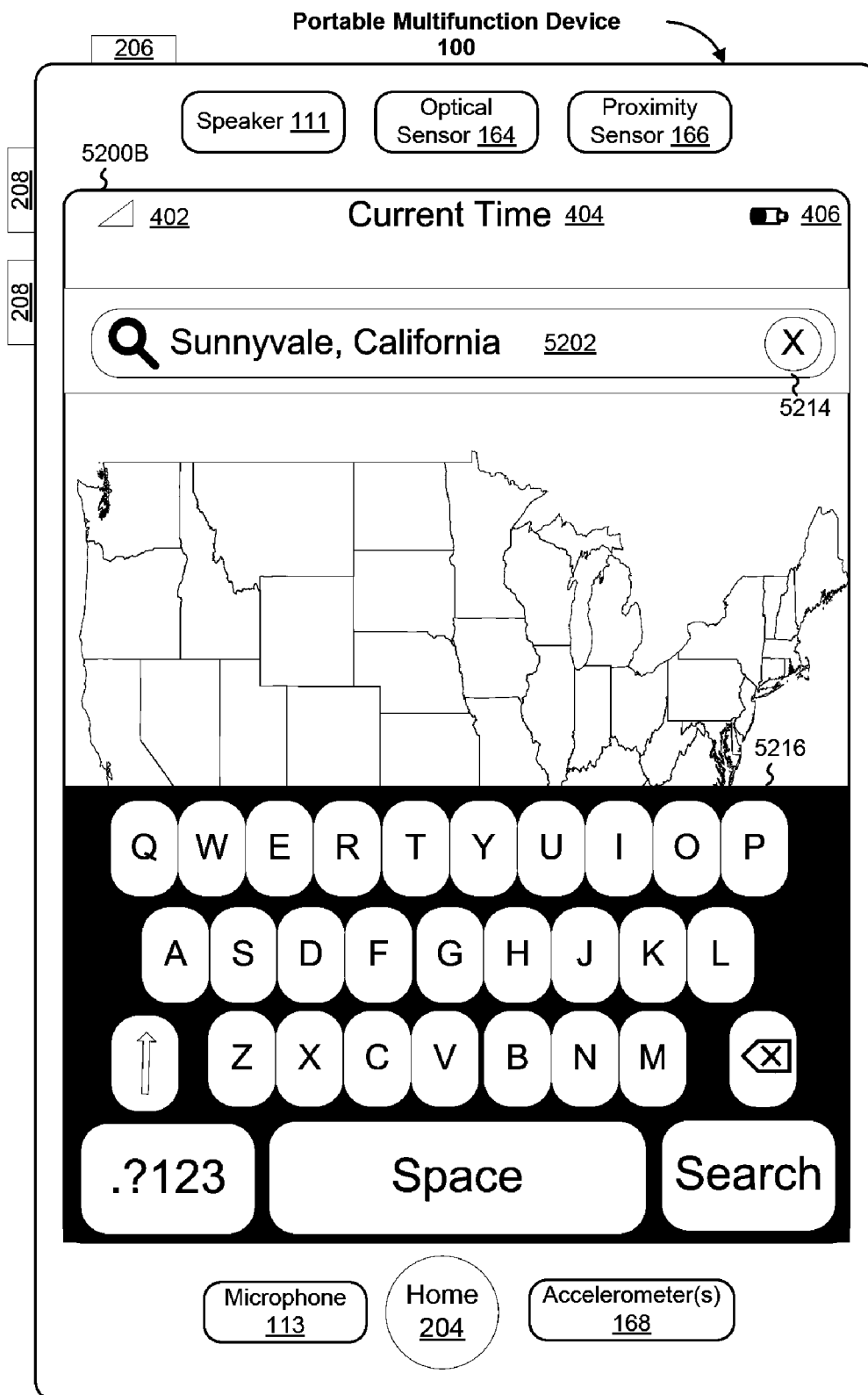

Figure 52B

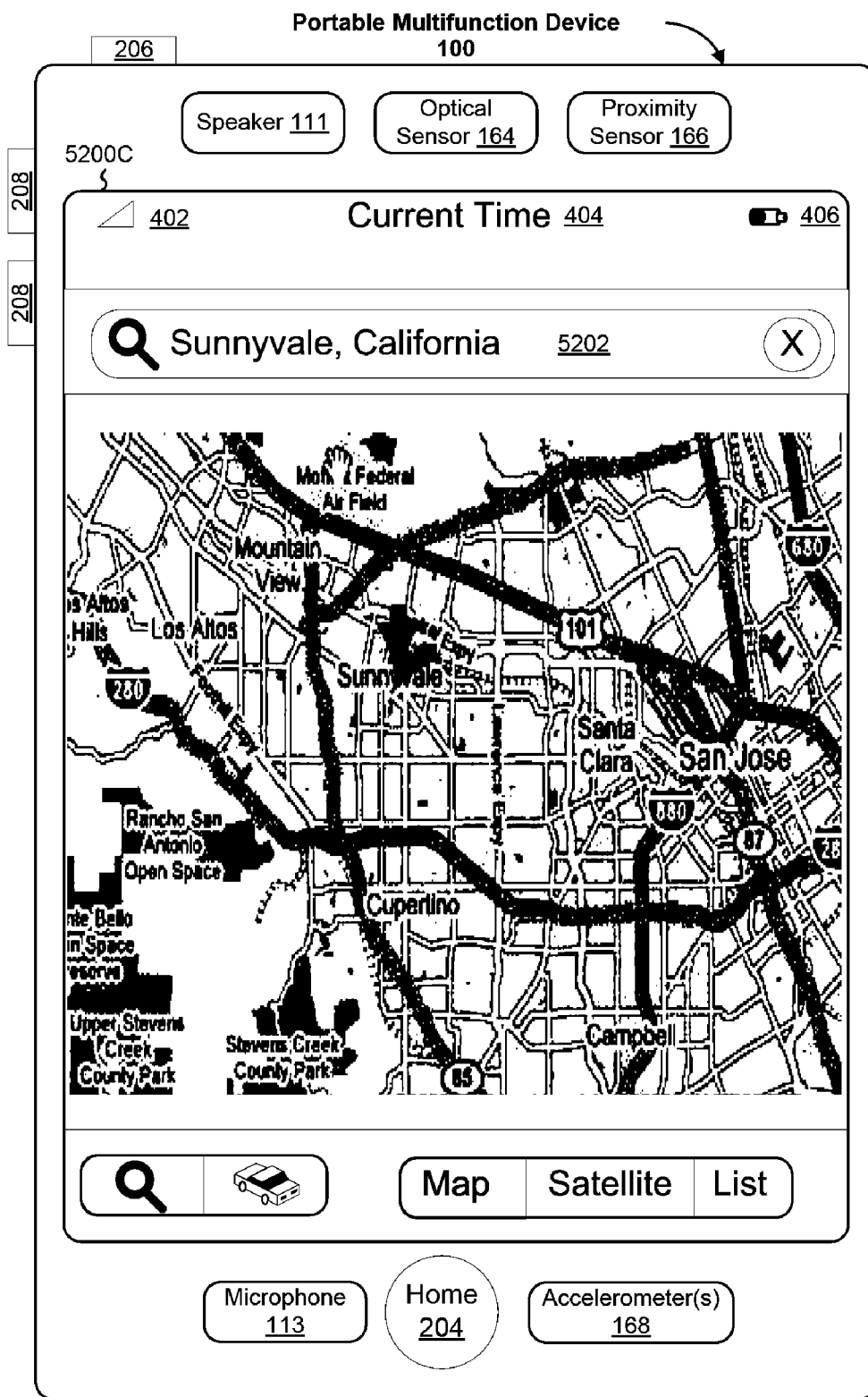

Figure 52C

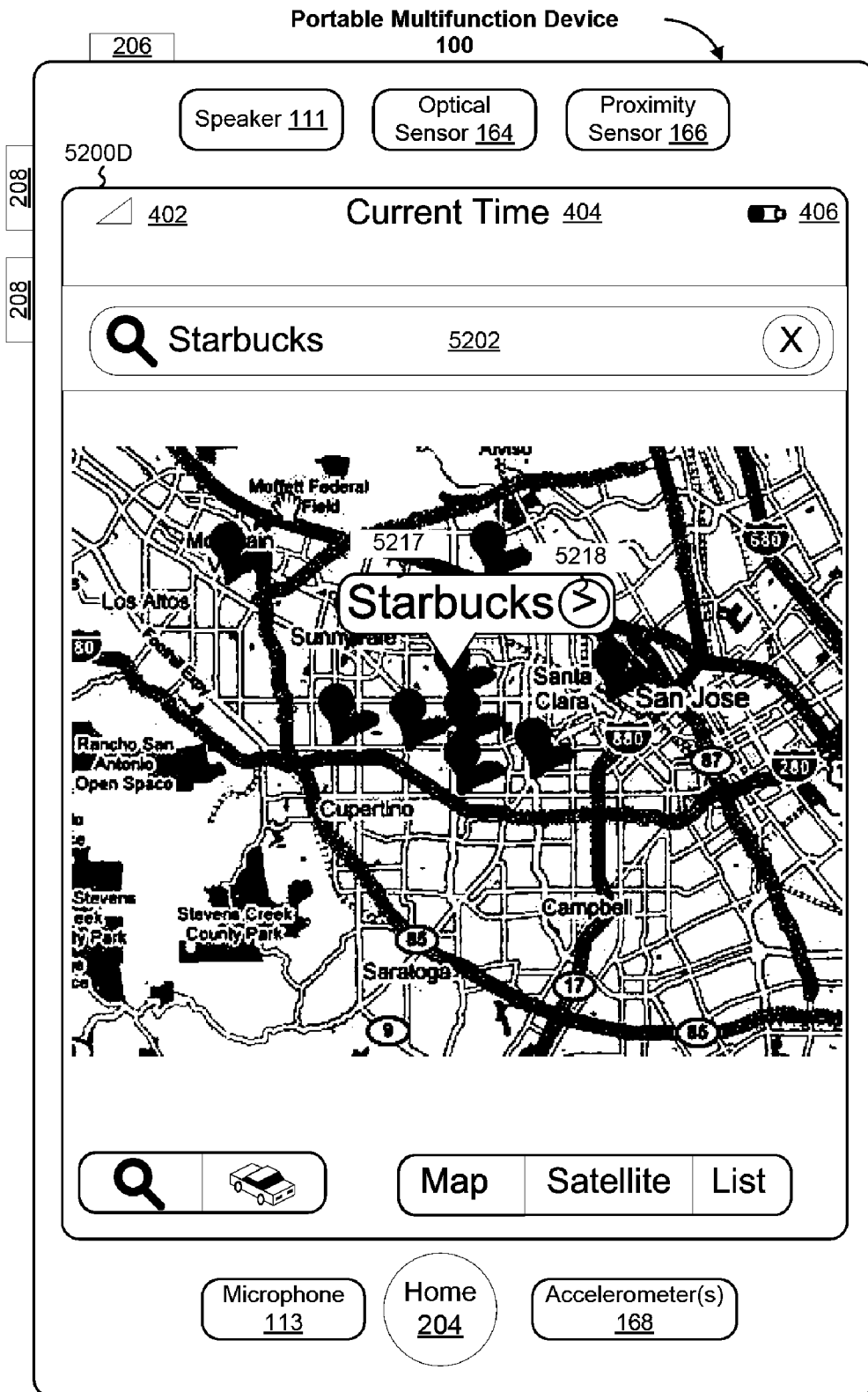

Figure 52D

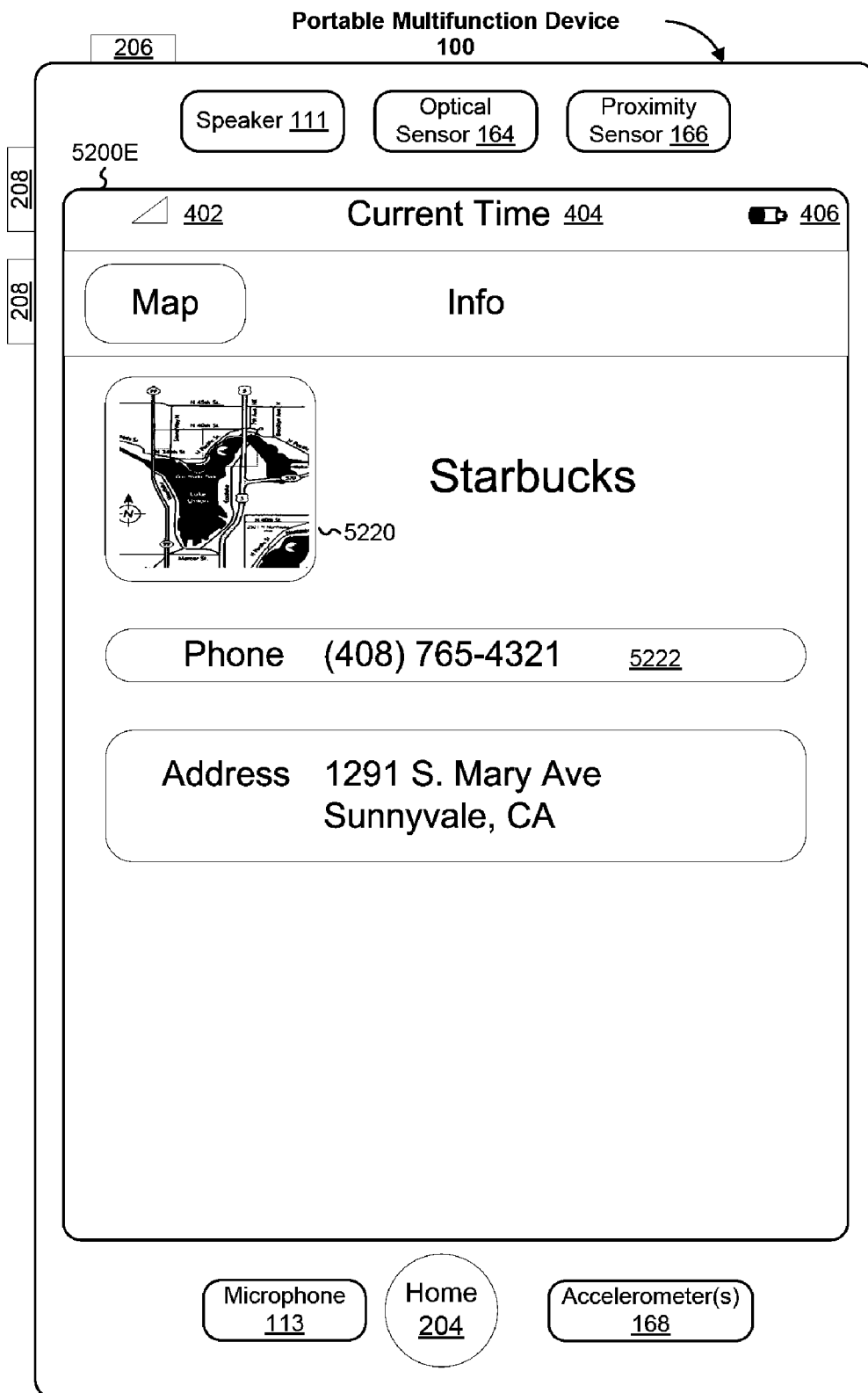

Figure 52E



Figure 52F

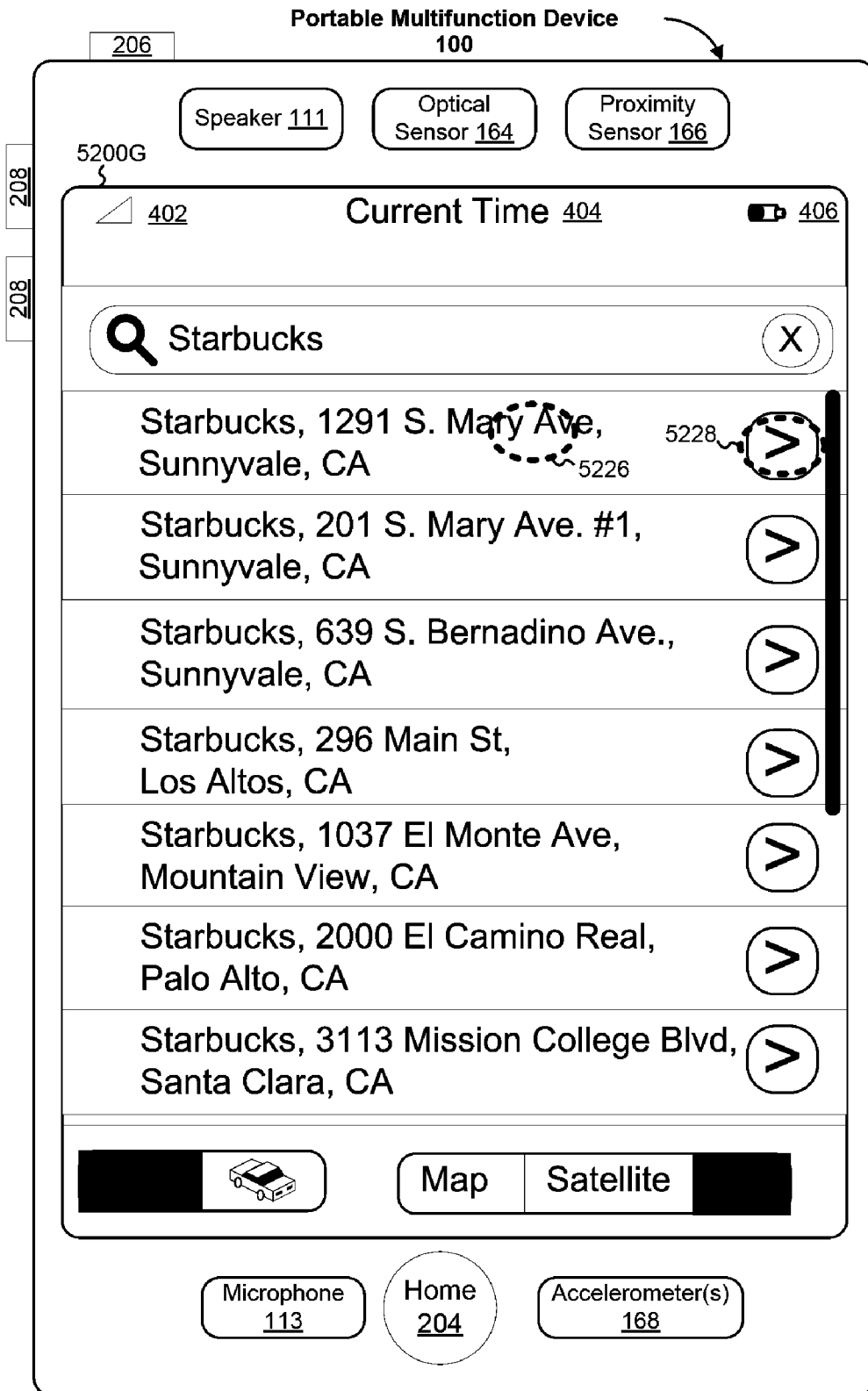

Figure 52G

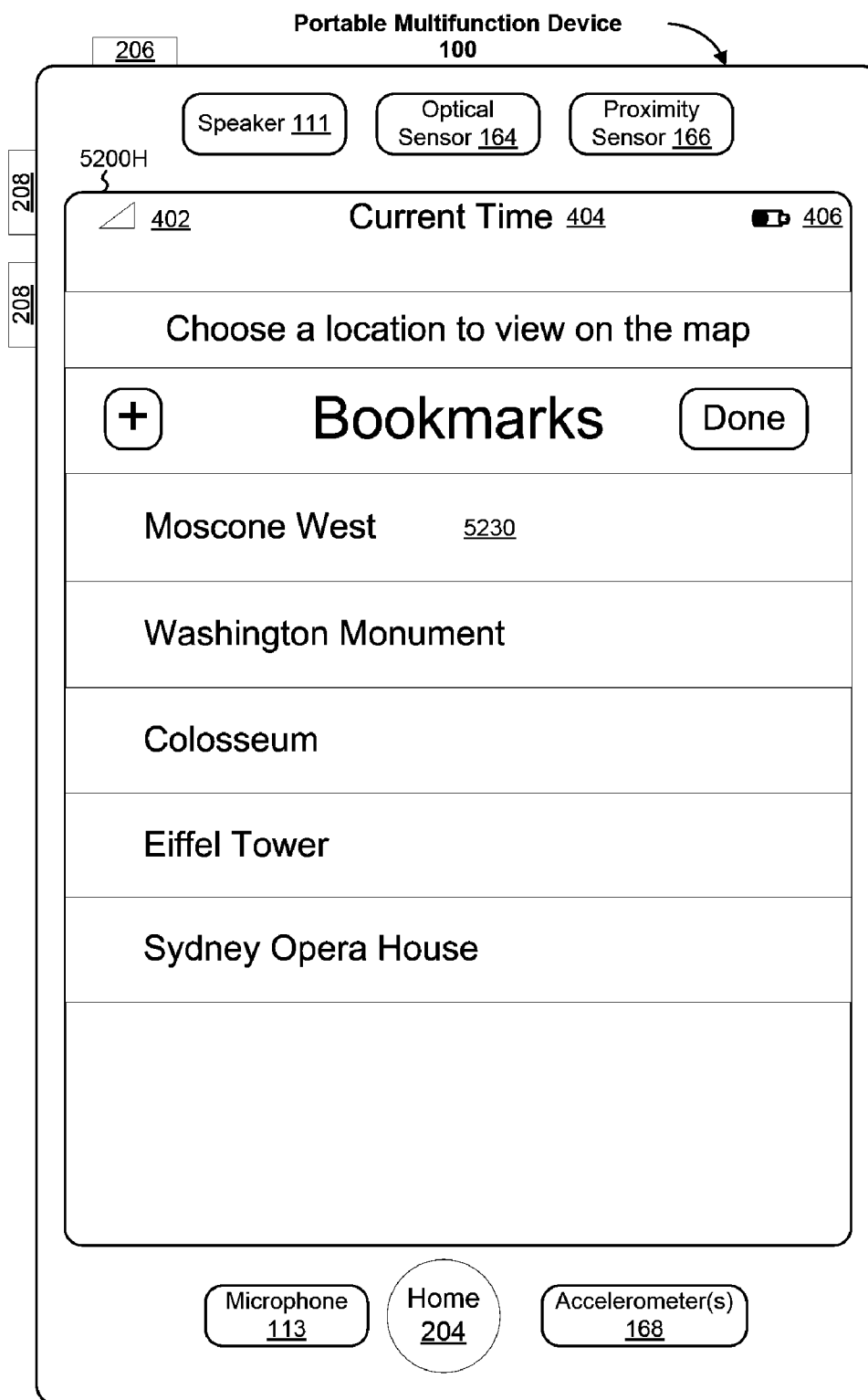

Figure 52H

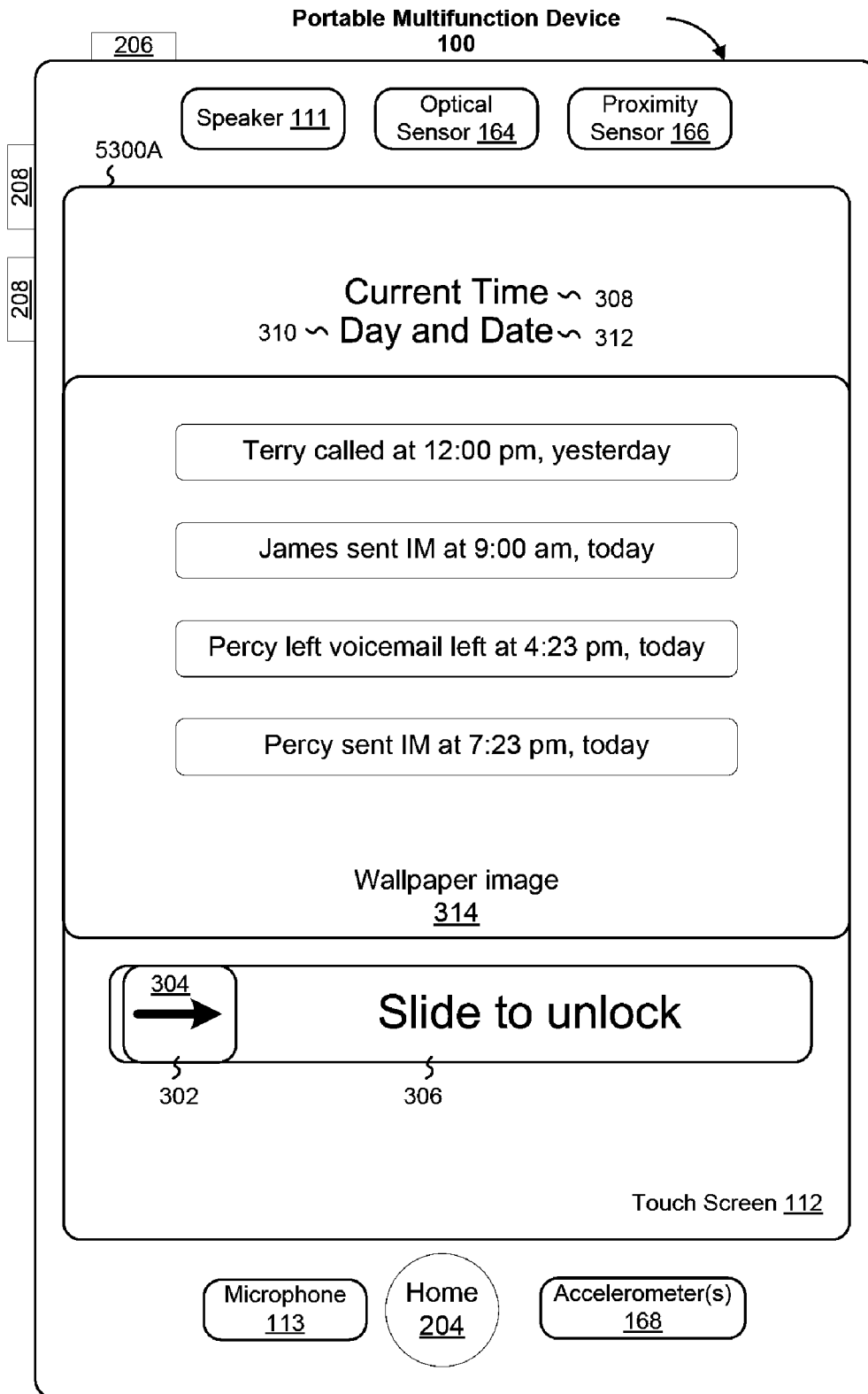

Figure 53A

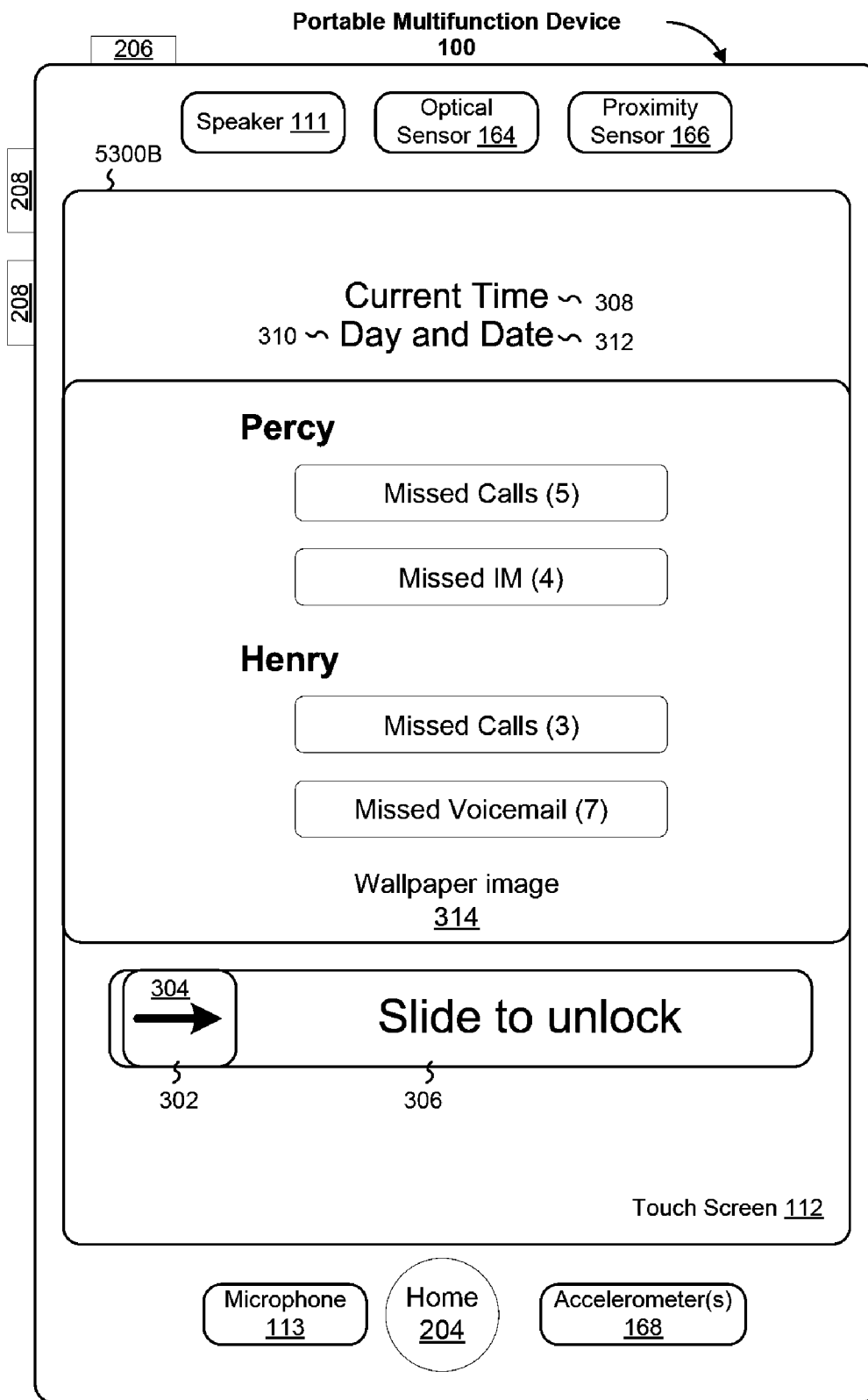

Figure 53B

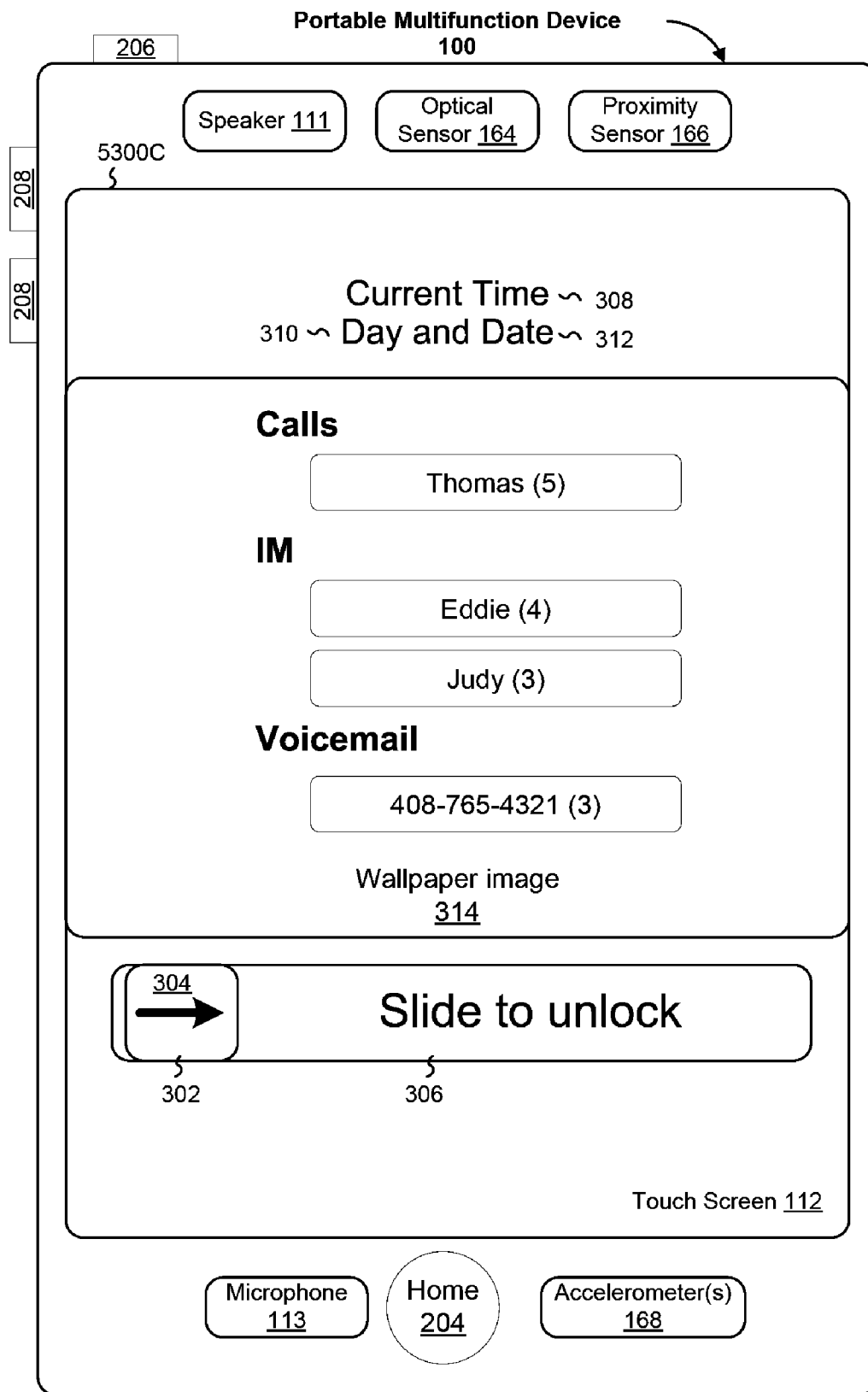

Figure 53C

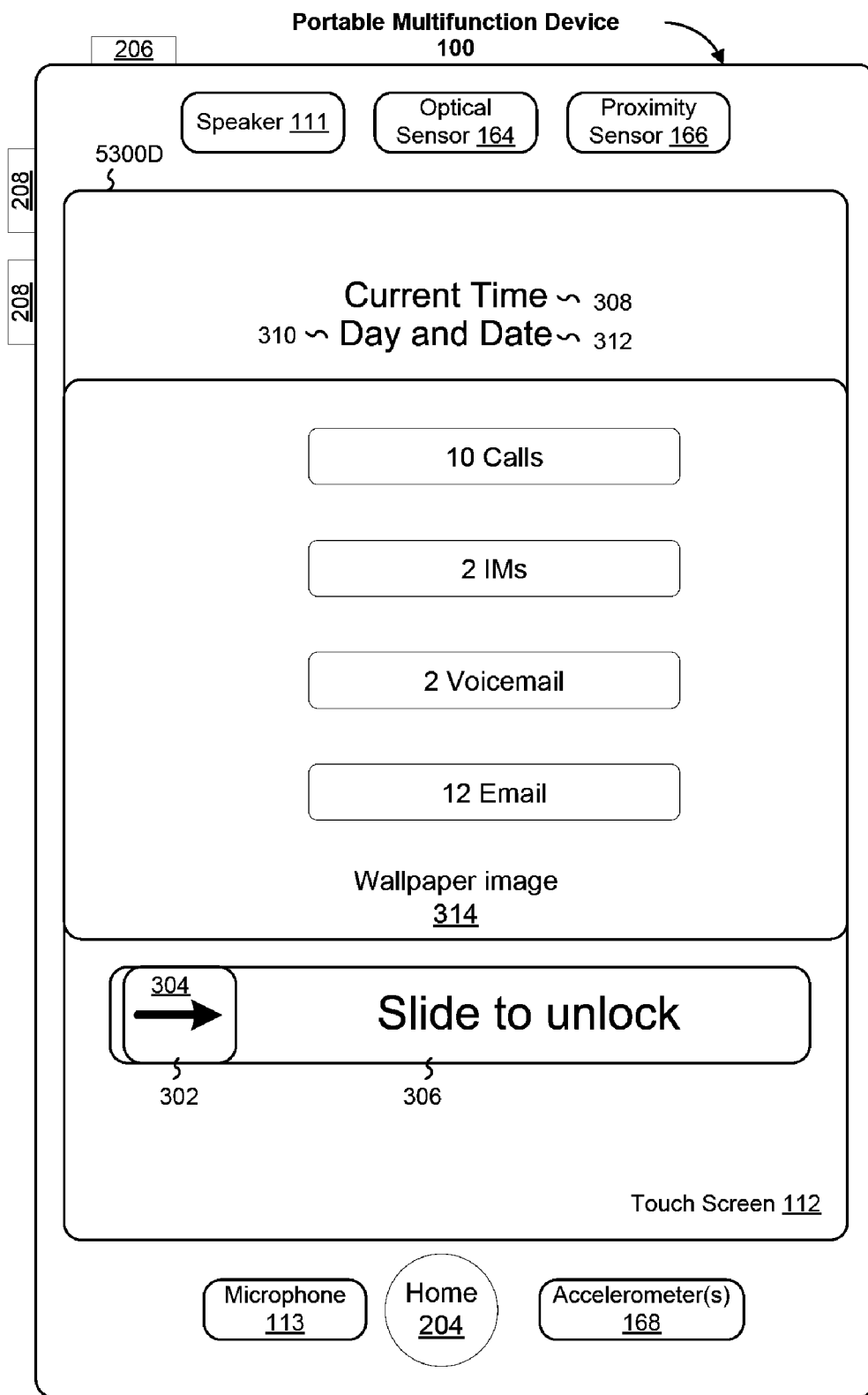

Figure 53D

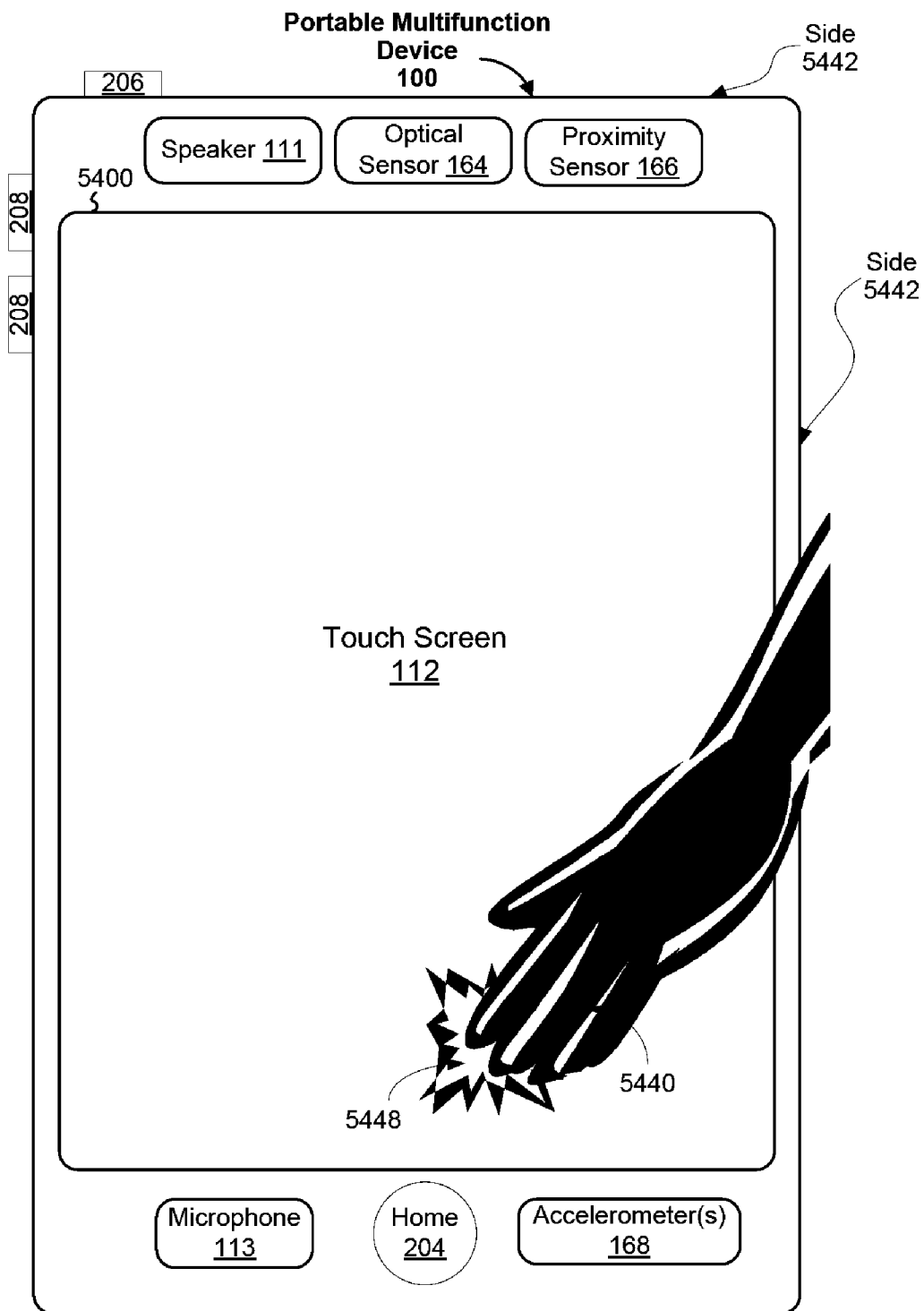

Figure 54

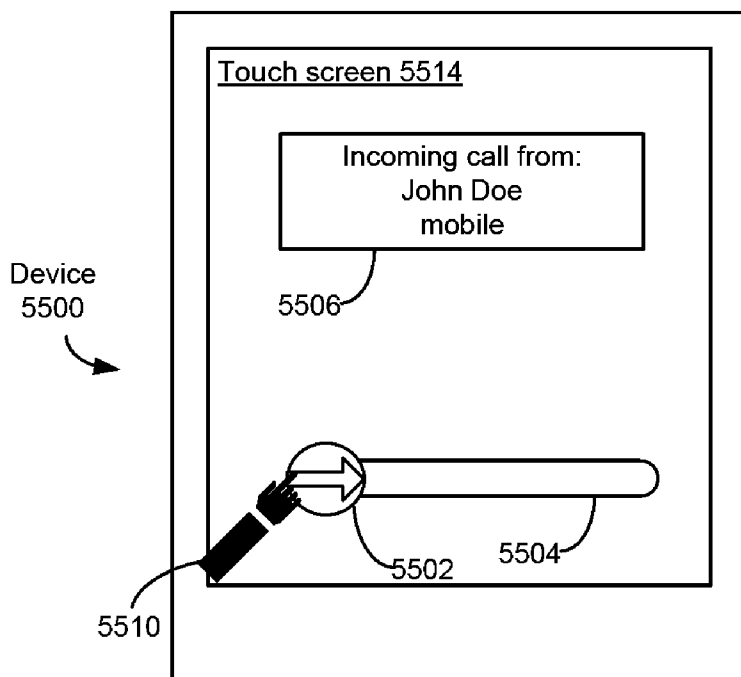

Figure 55A

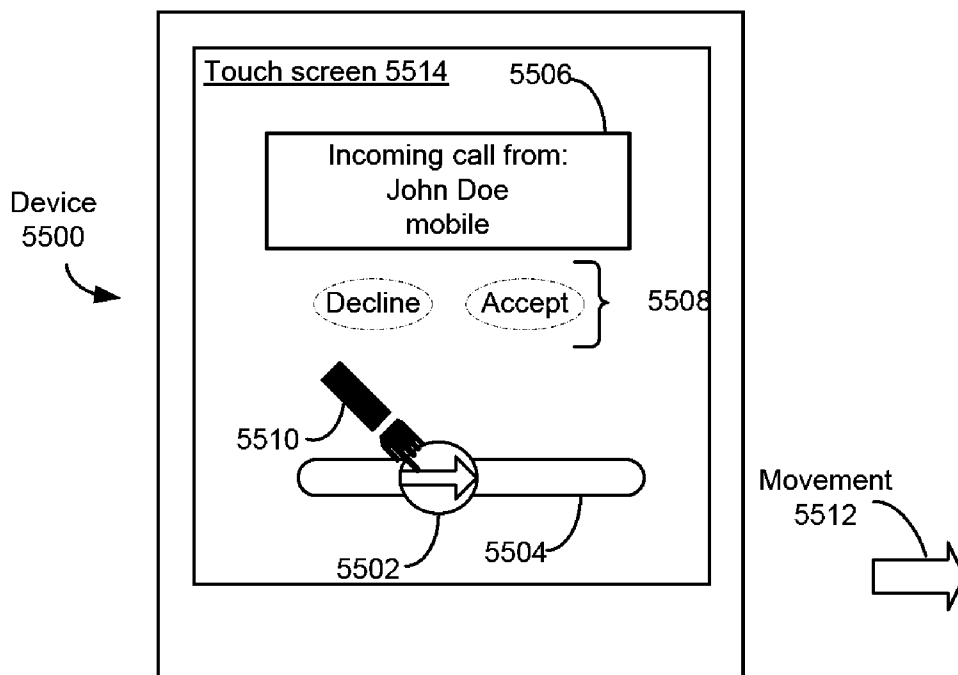

Figure 55B

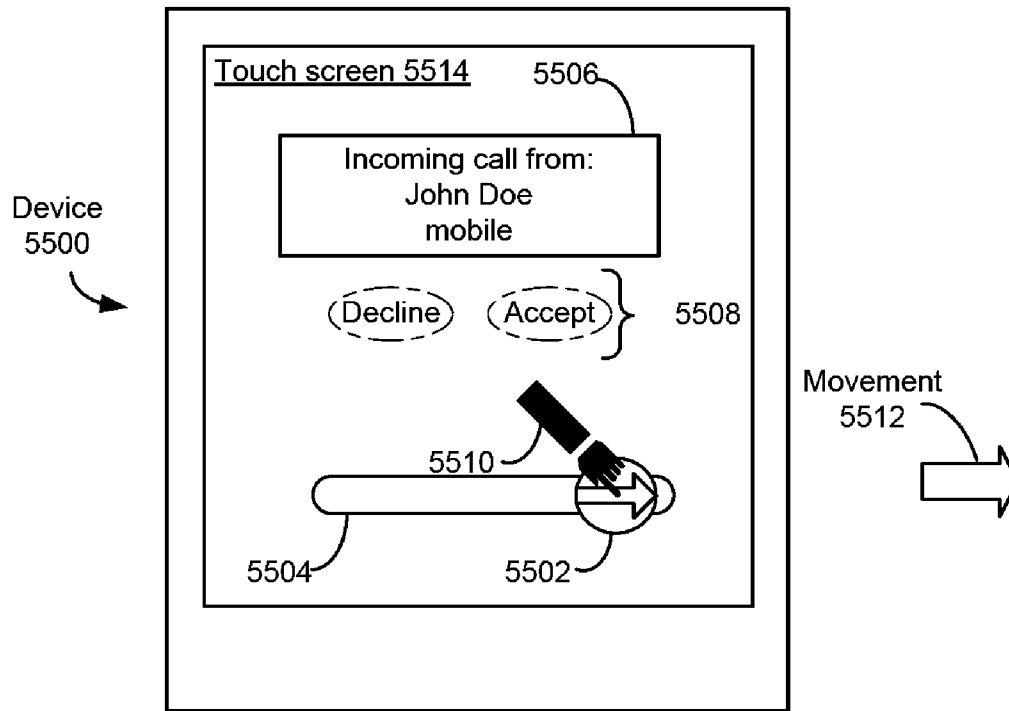

Figure 55C

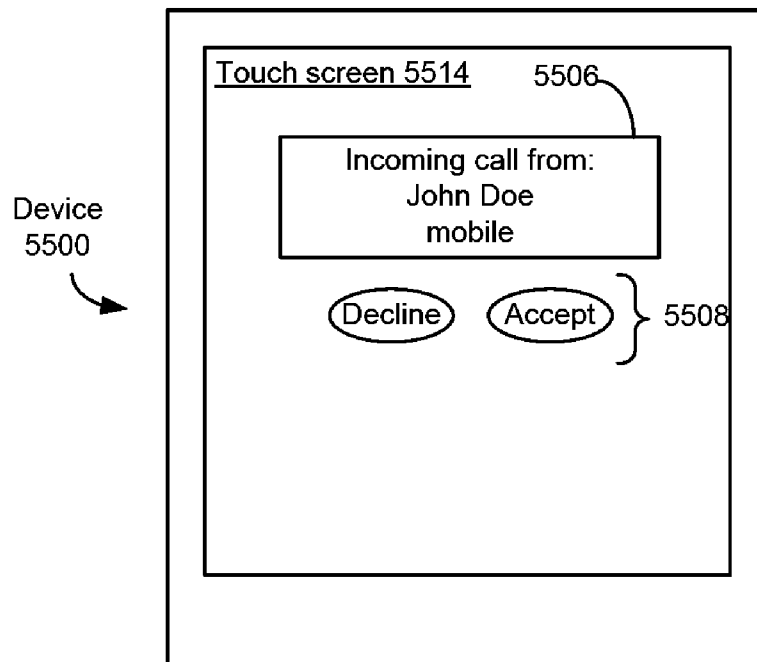

Figure 55D

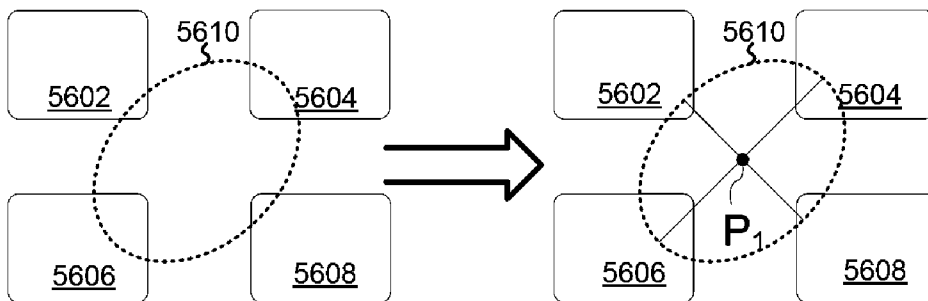

Figure 56A

Figure 56B

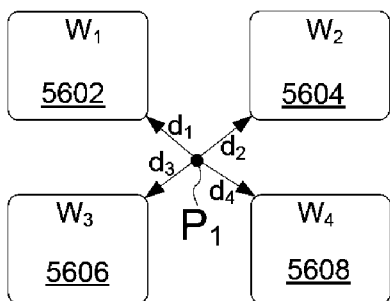

Figure 56C

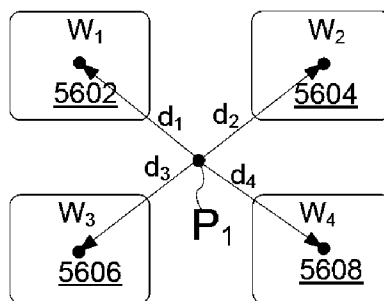

Figure 56D

W_1' and W_1'' are two numbers with opposite signs

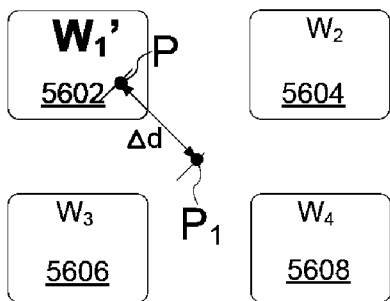

Figure 56E

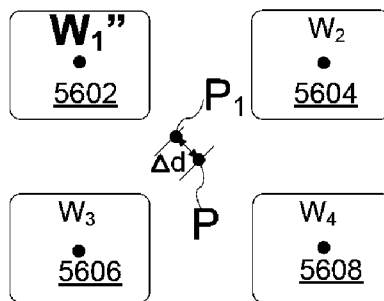

Figure 56F

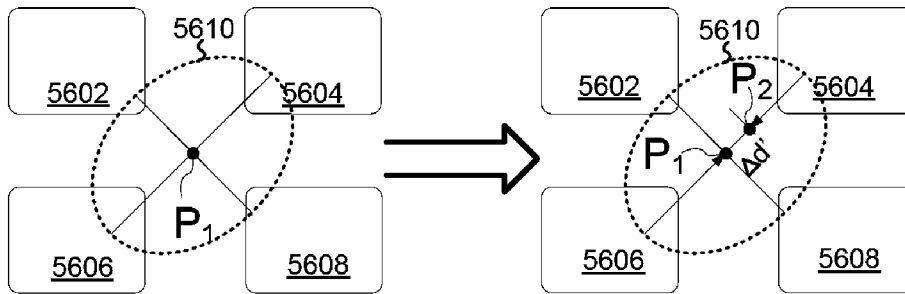

Figure 56G

Figure 56H

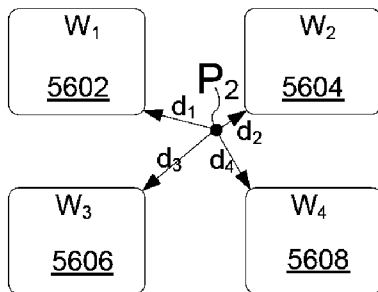

Figure 56I

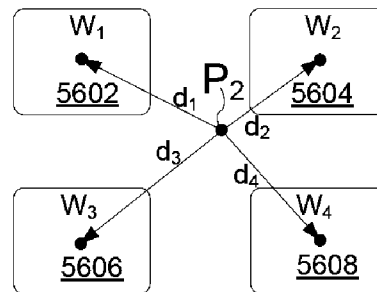

Figure 56J

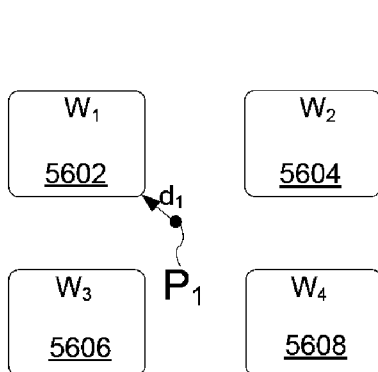

Figure 56K

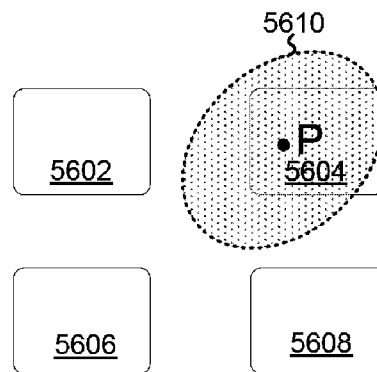

Figure 56L

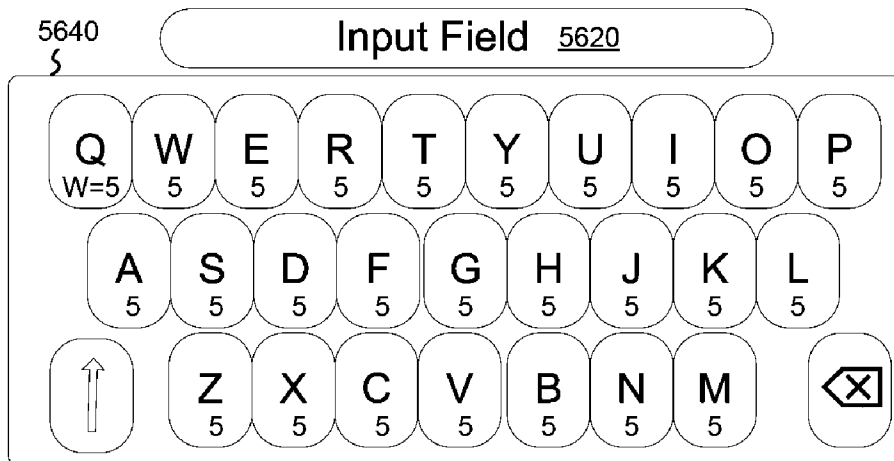

Figure 56M

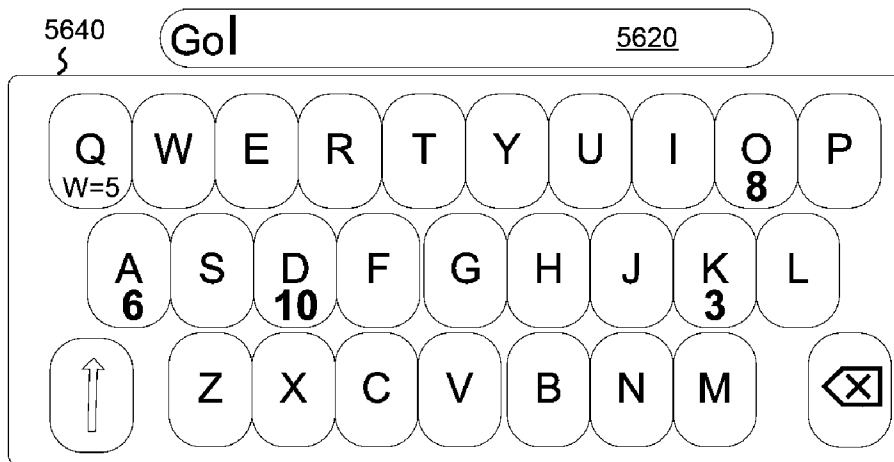

Figure 56N

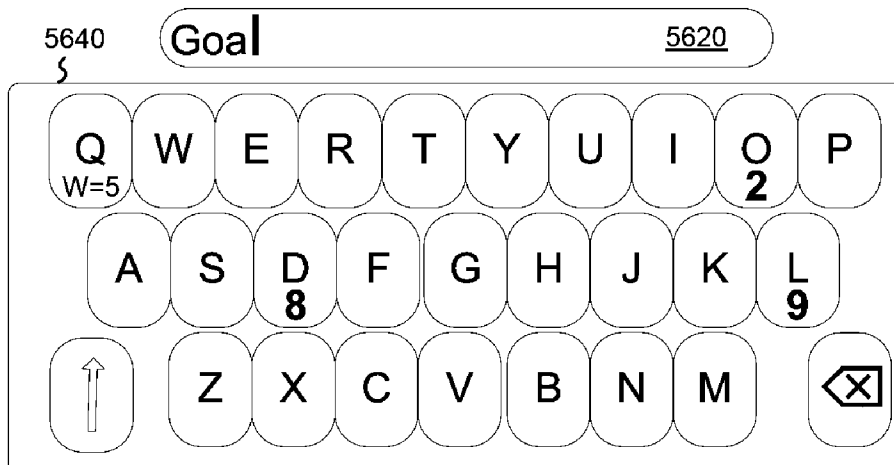
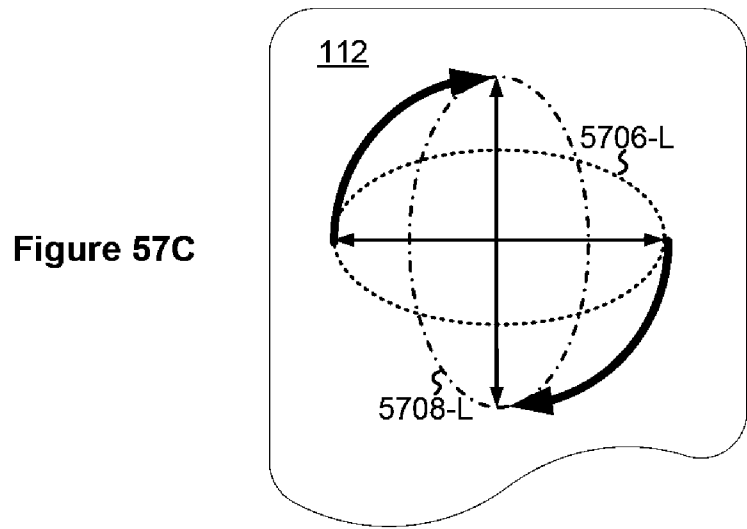
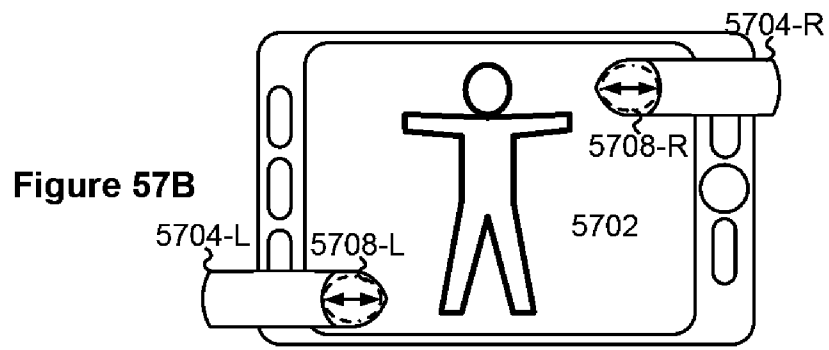
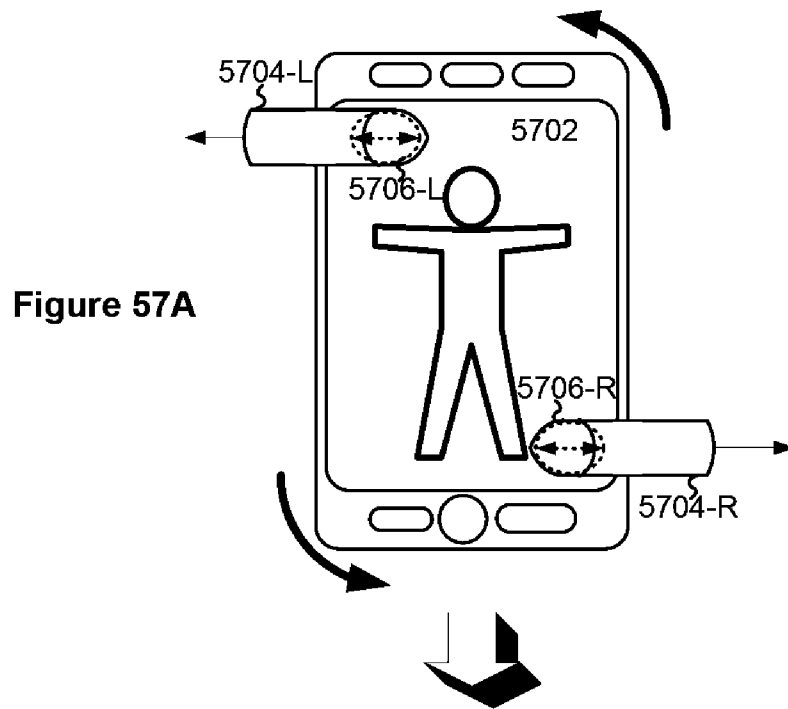

Figure 56O



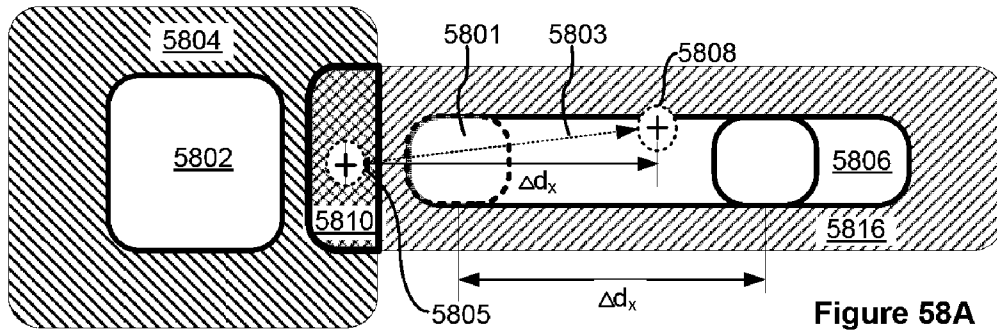

Figure 58A

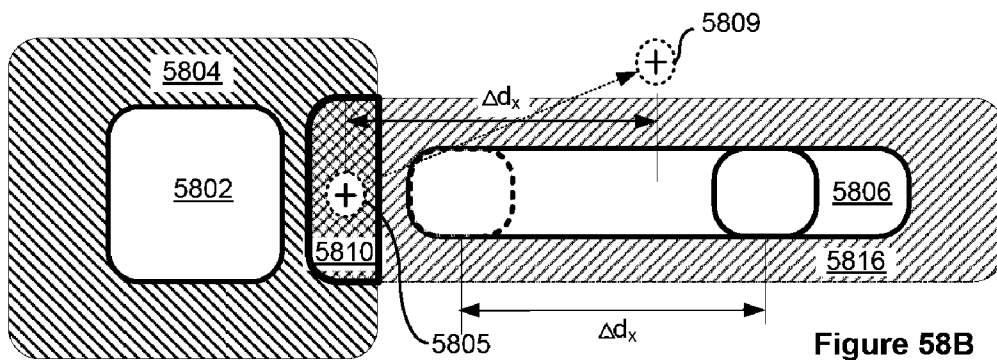

Figure 58B

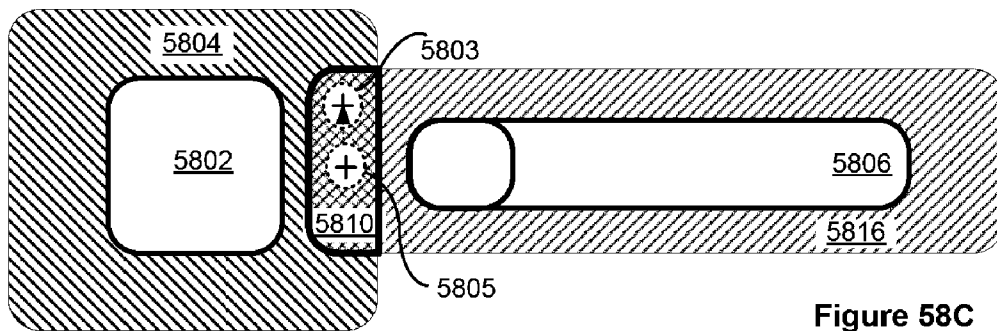

Figure 58C

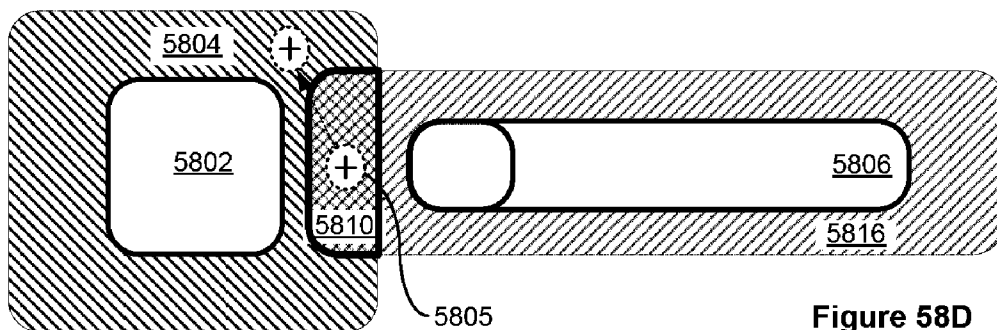

Figure 58D

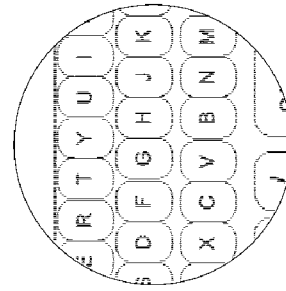
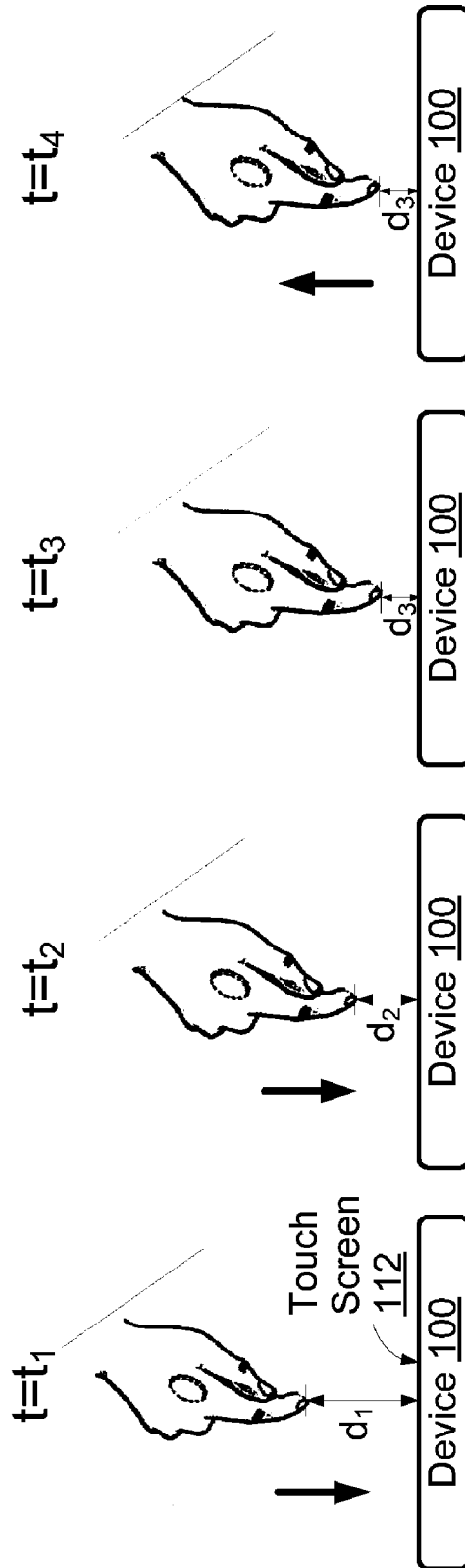

Figure 59D

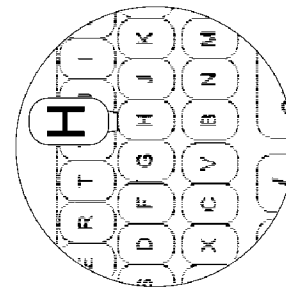

Figure 59C

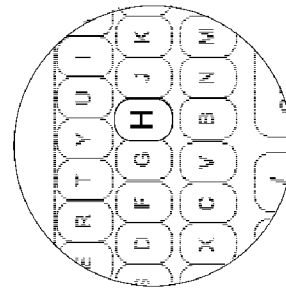

Figure 59B

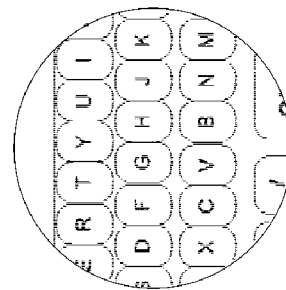

Figure 59A

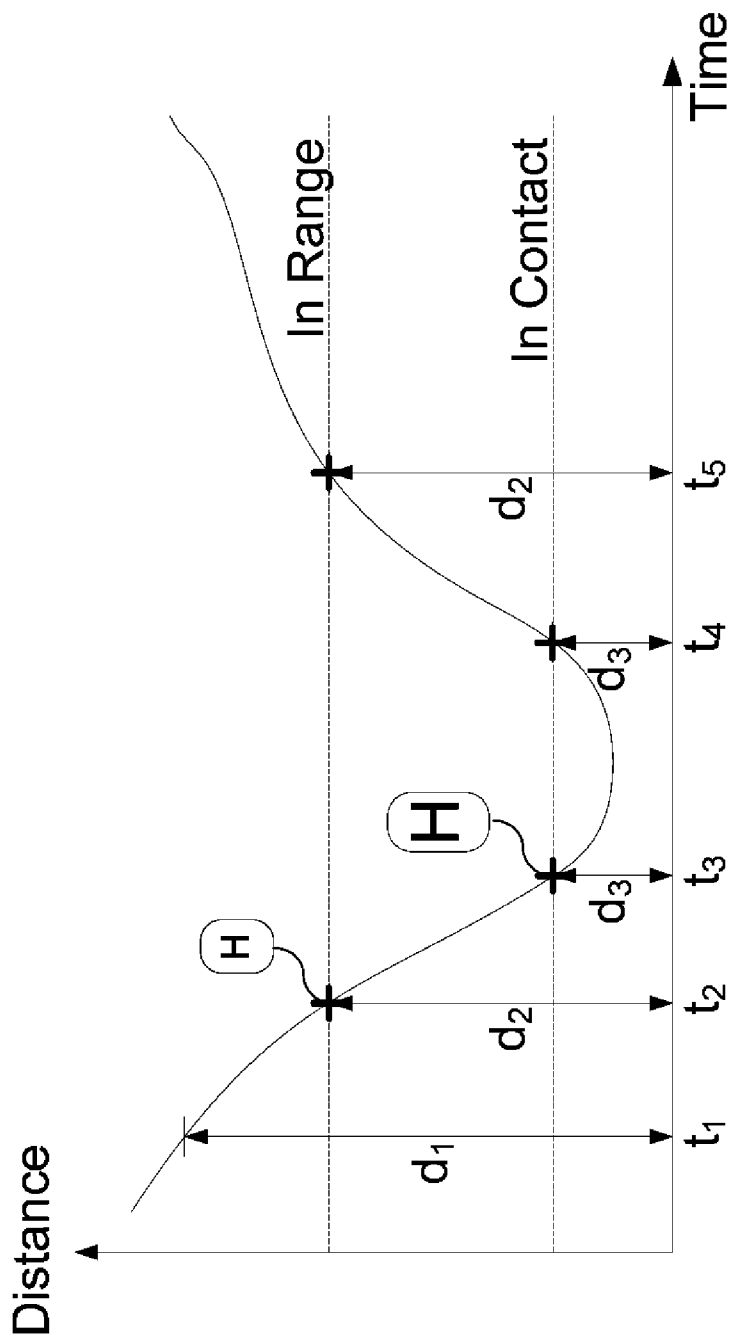

Figure 59E

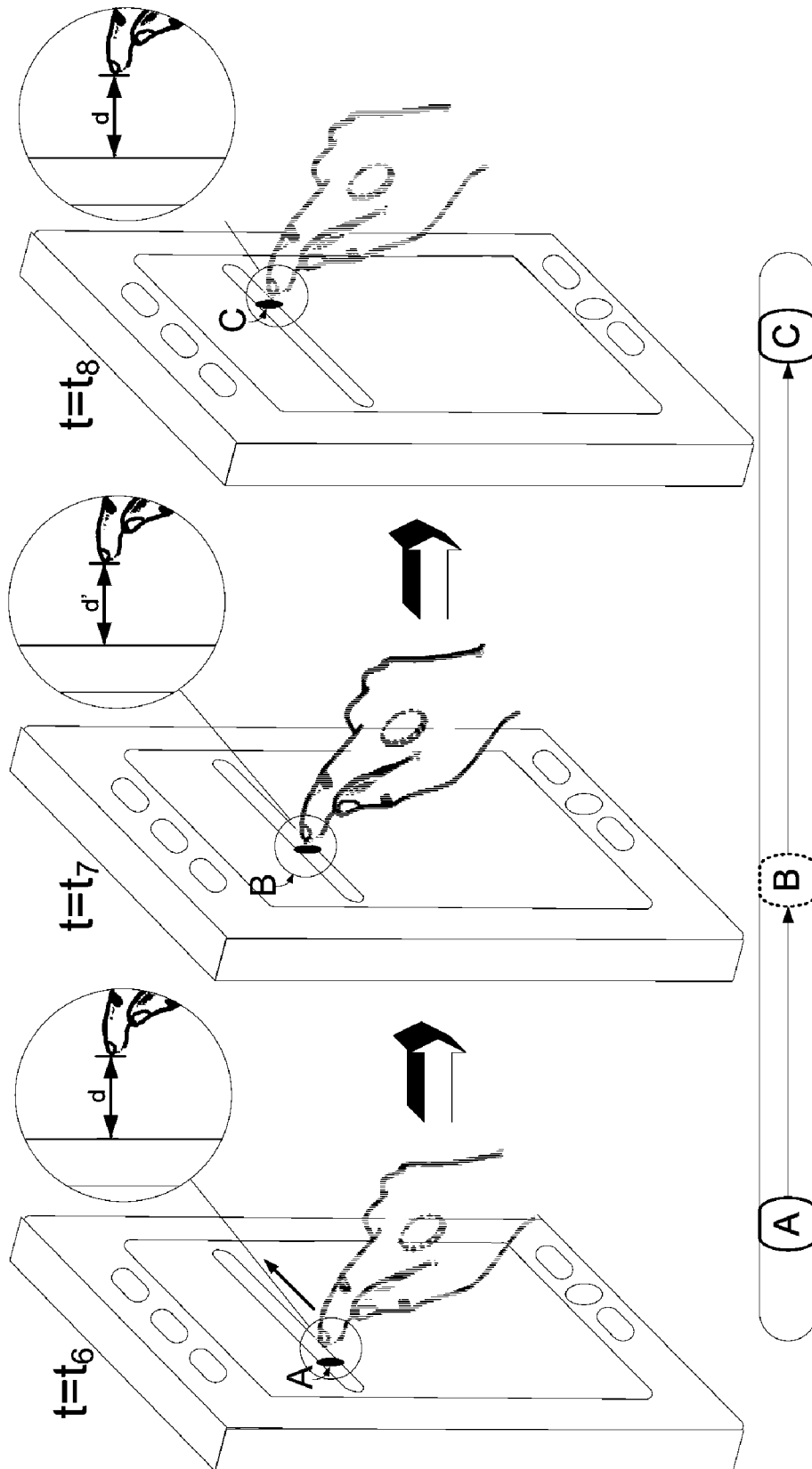

Figure 59F

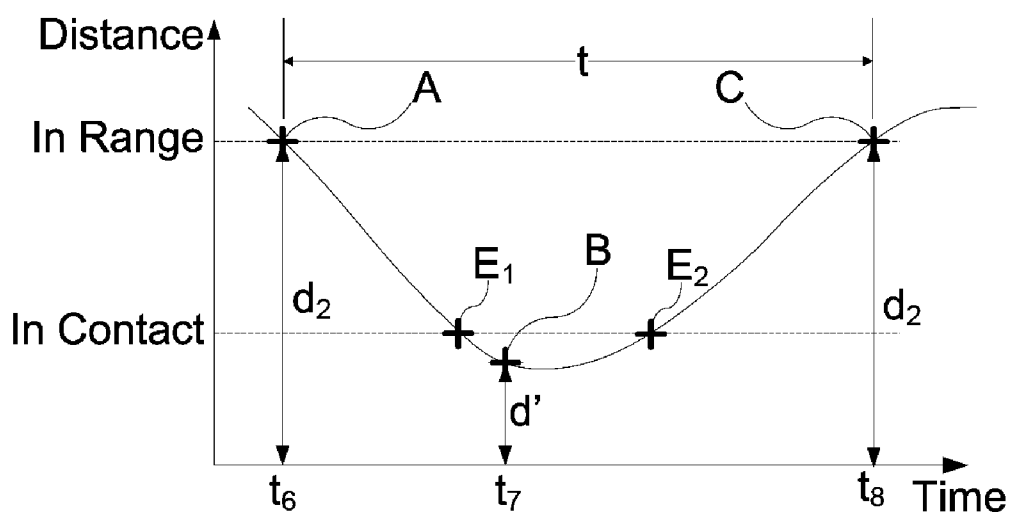

Figure 59G

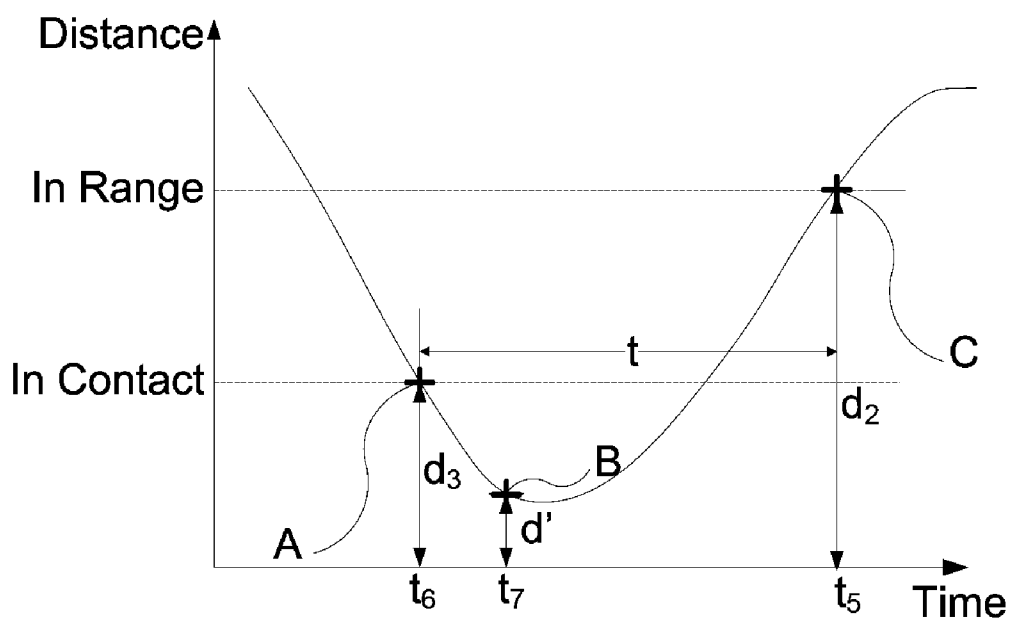

Figure 59H

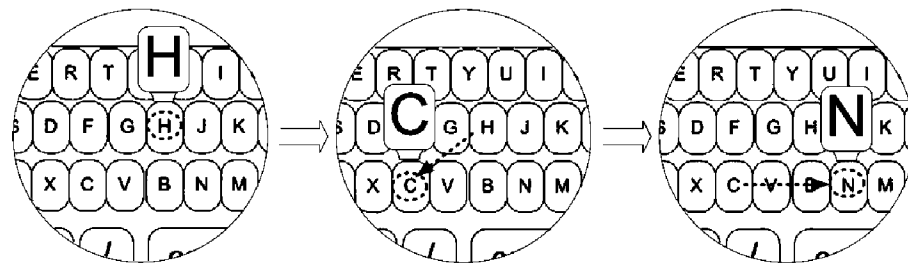
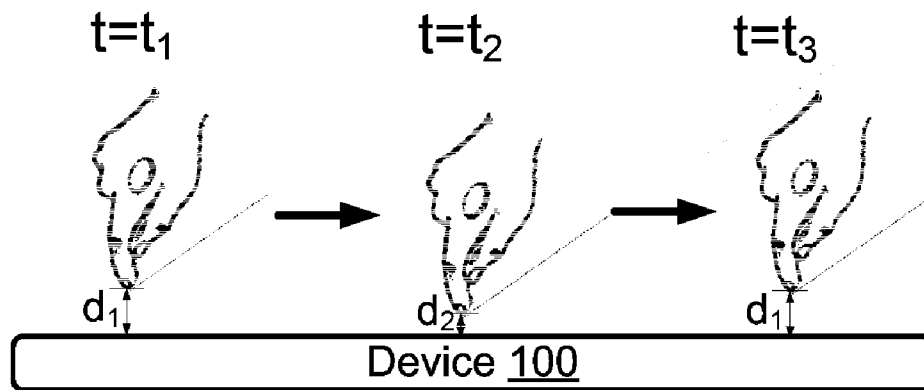

Figure 60A

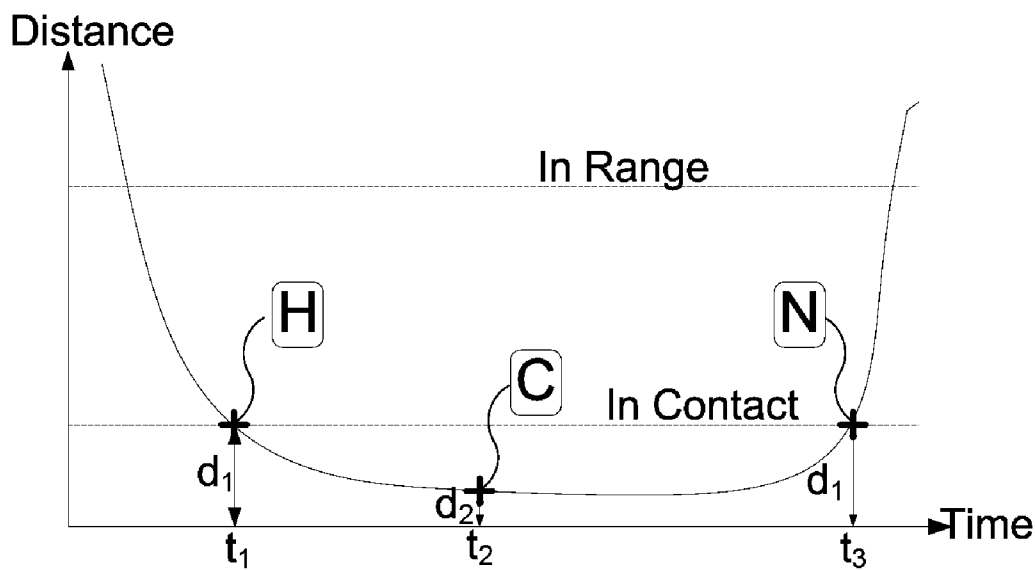

Figure 60B

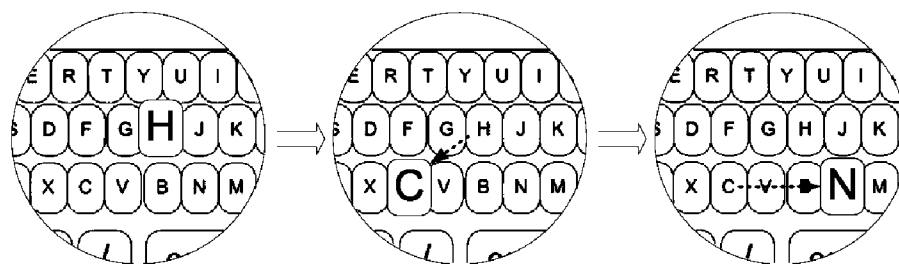
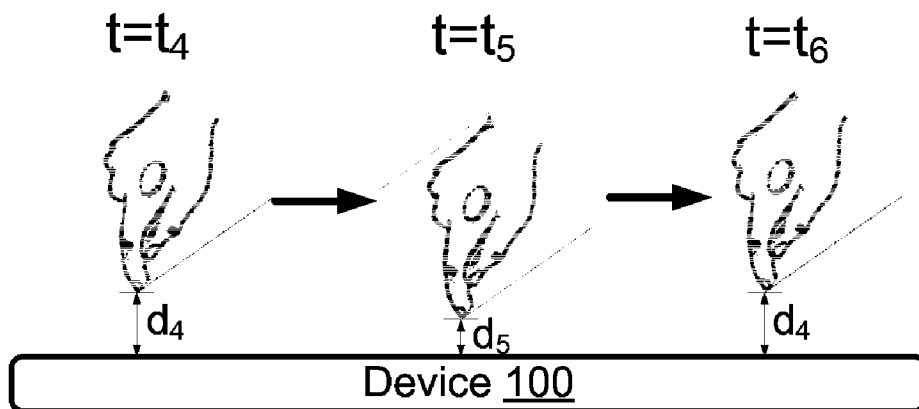

Figure 60C

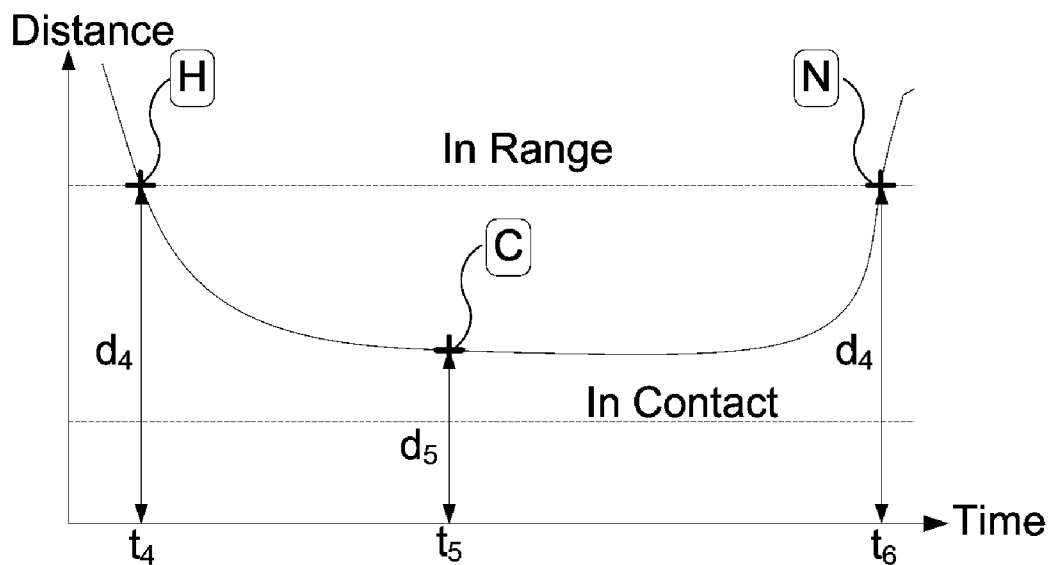

Figure 60D

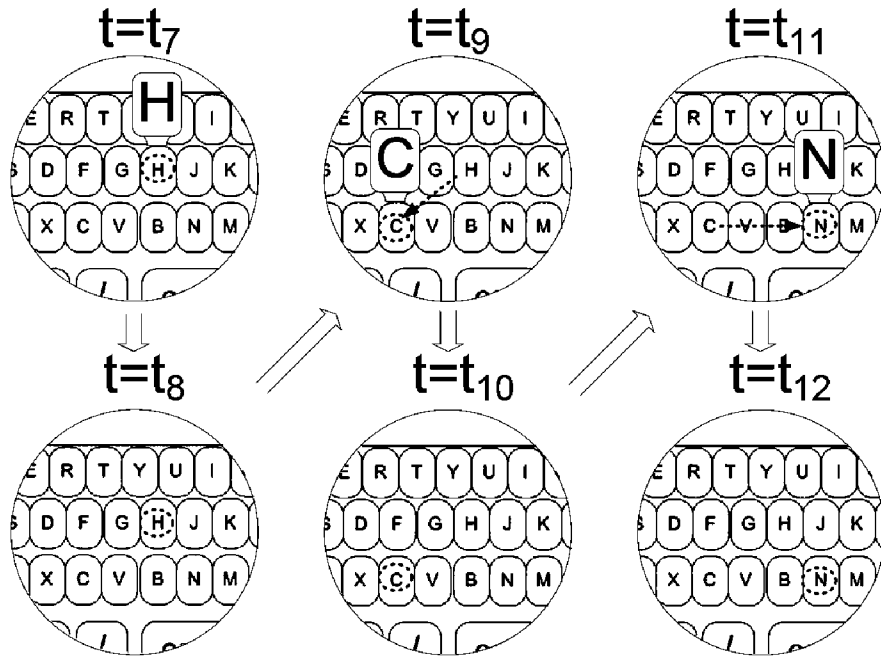
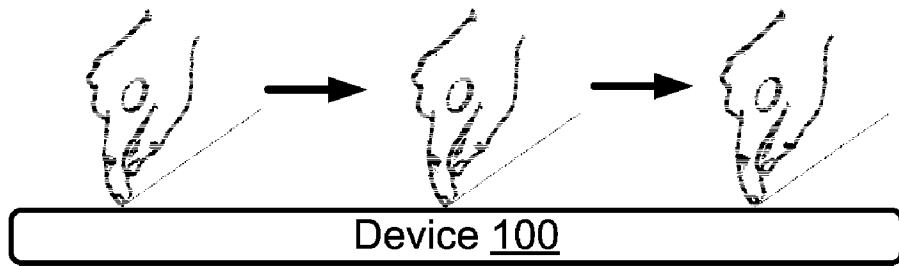

Figure 60E

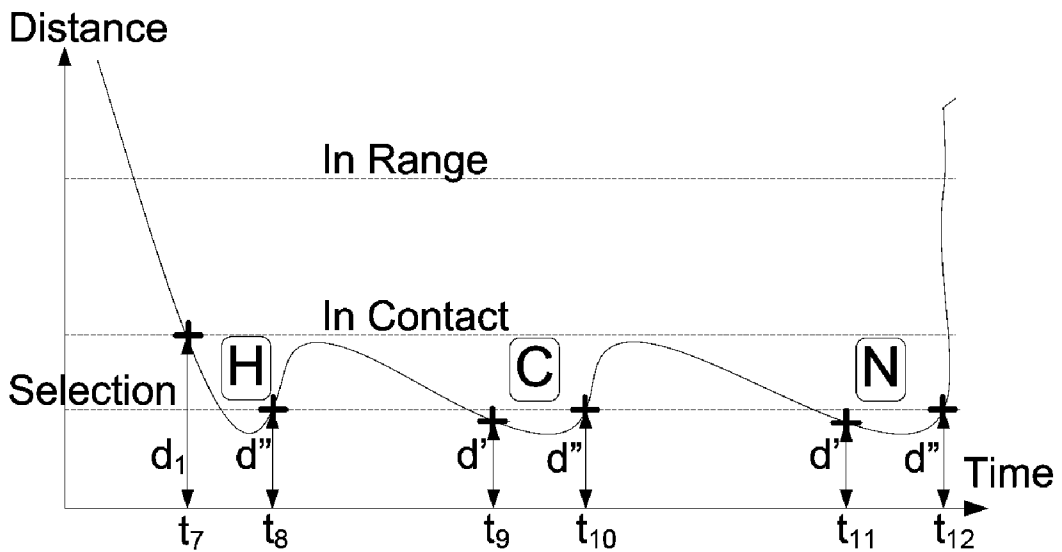

Figure 60F

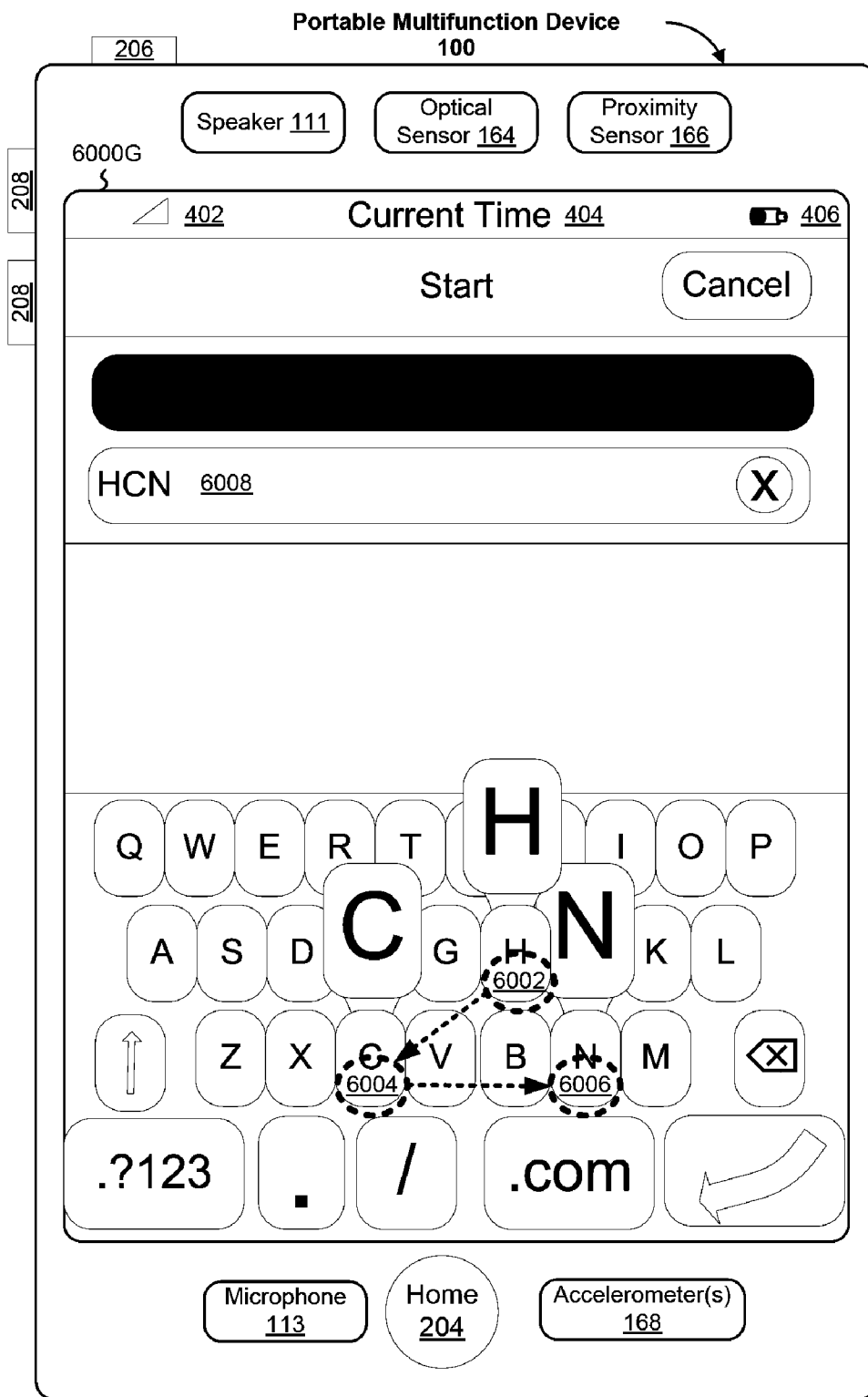

Figure 60G

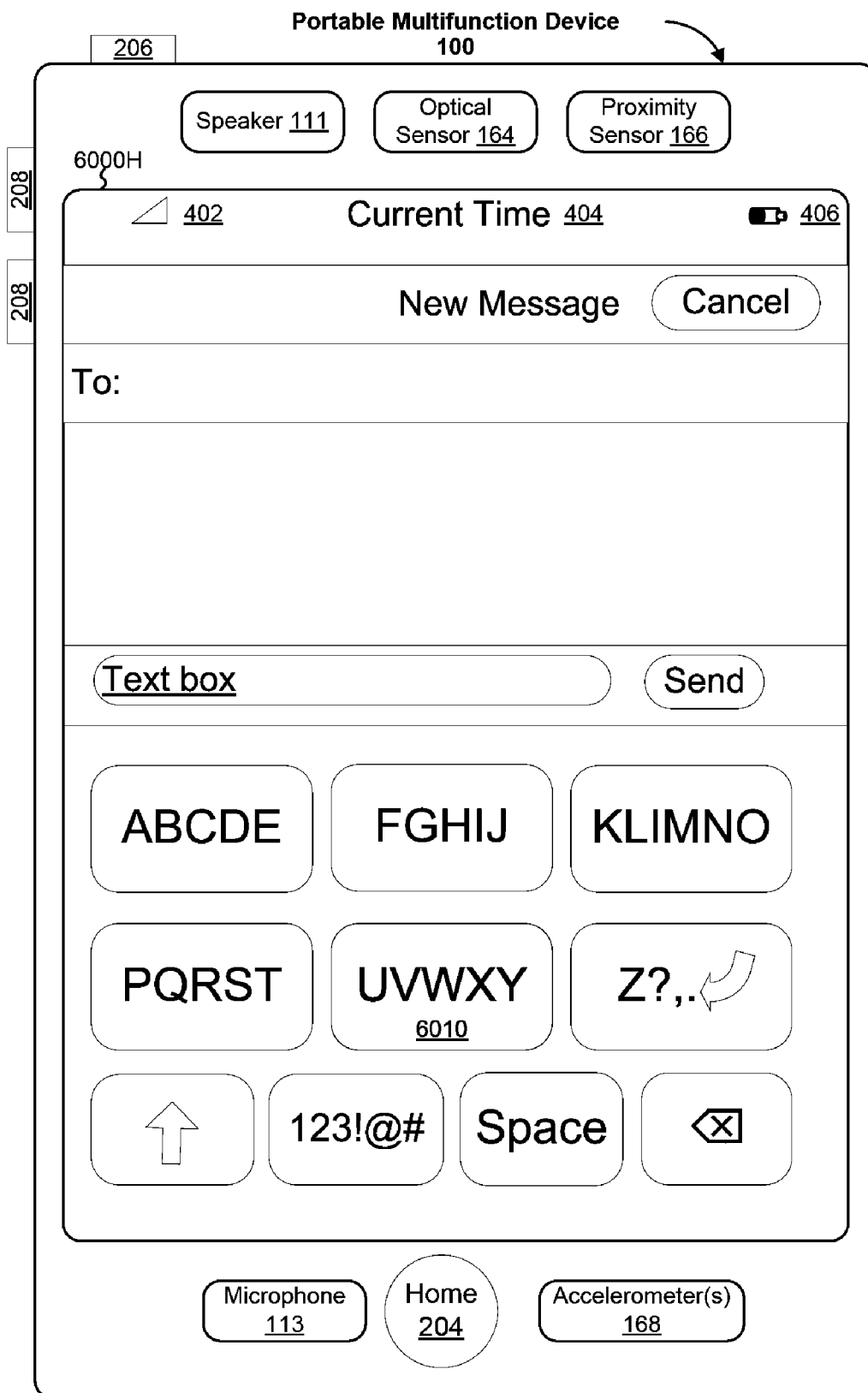

Figure 60H

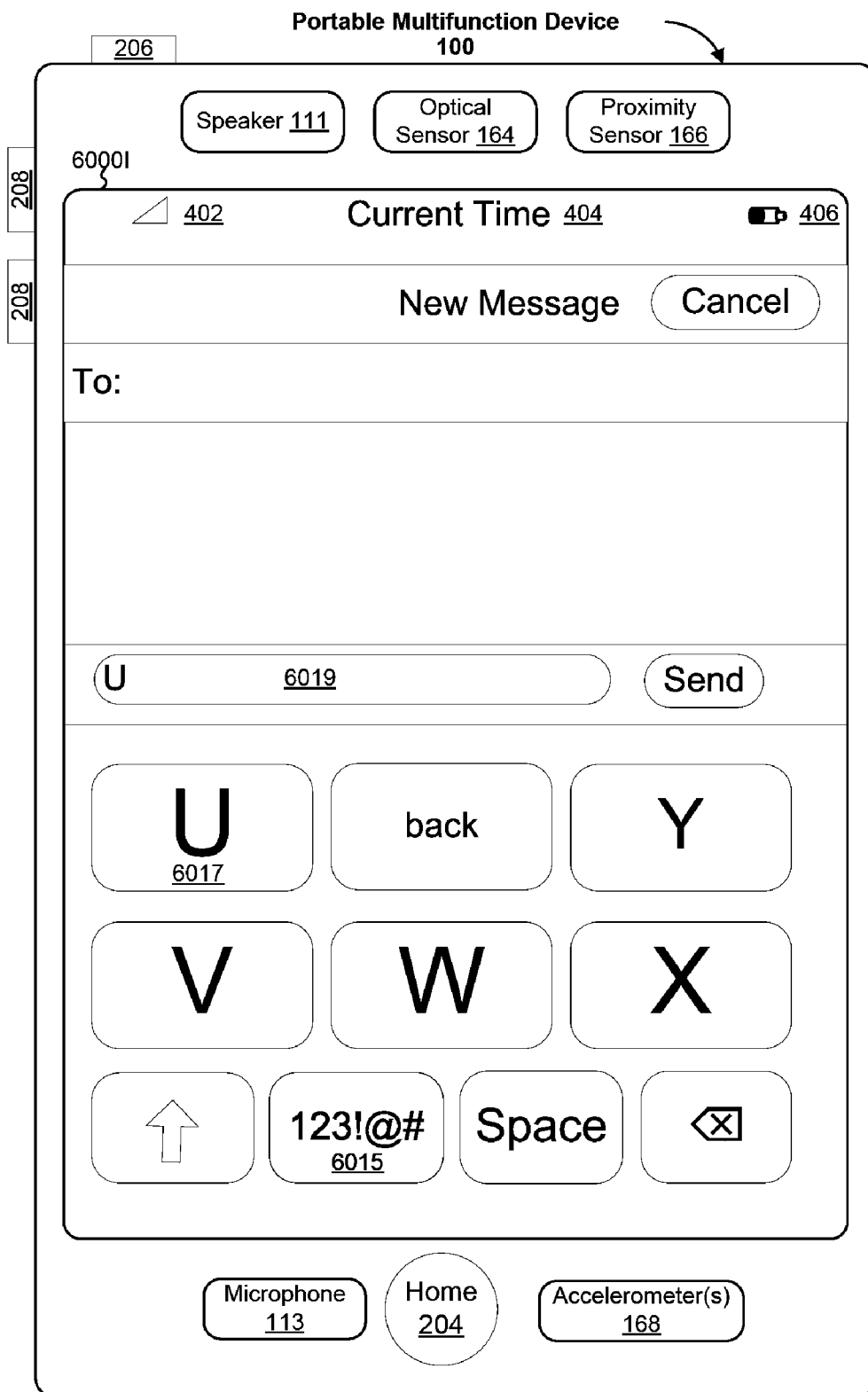

Figure 60I

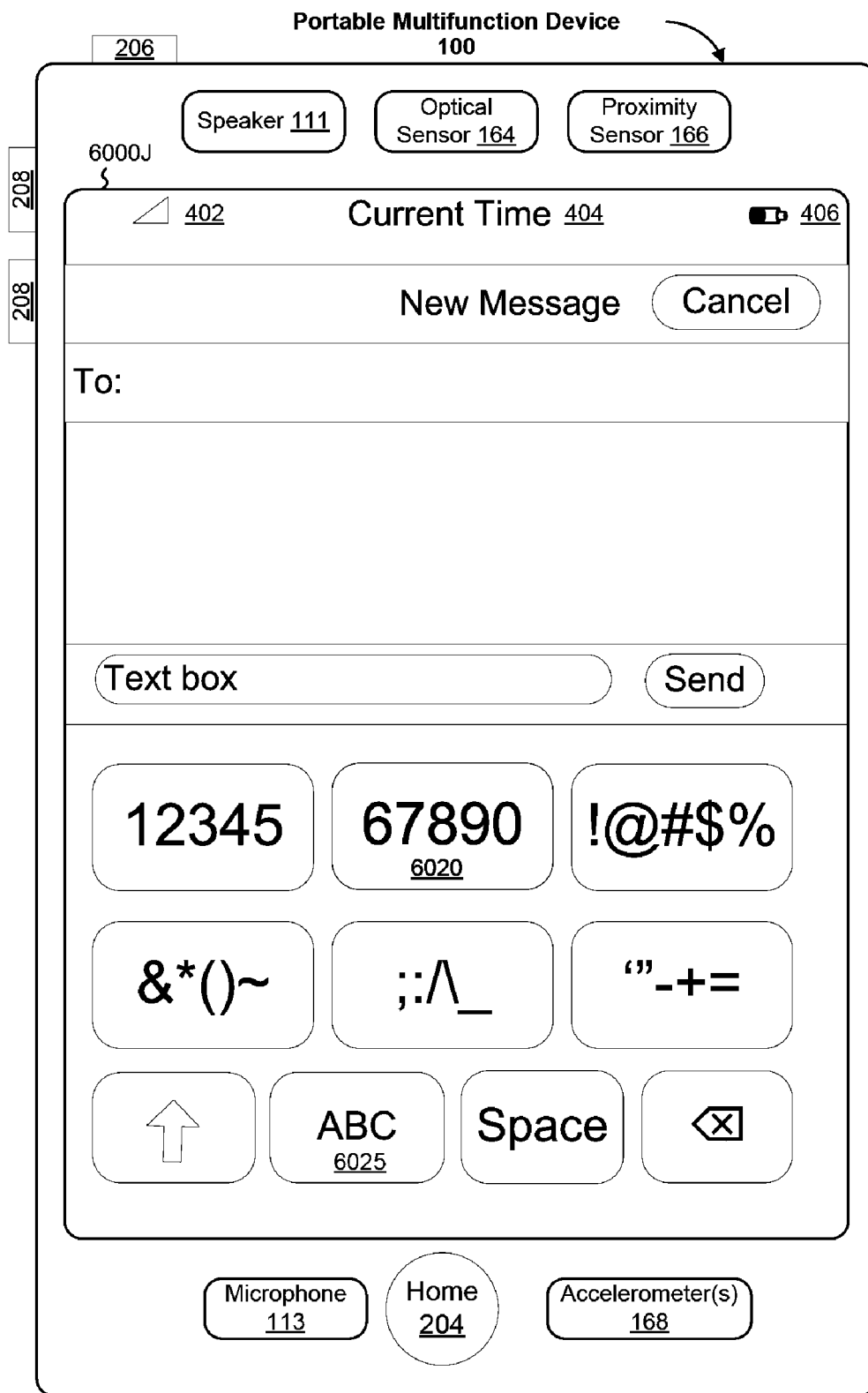

Figure 60J

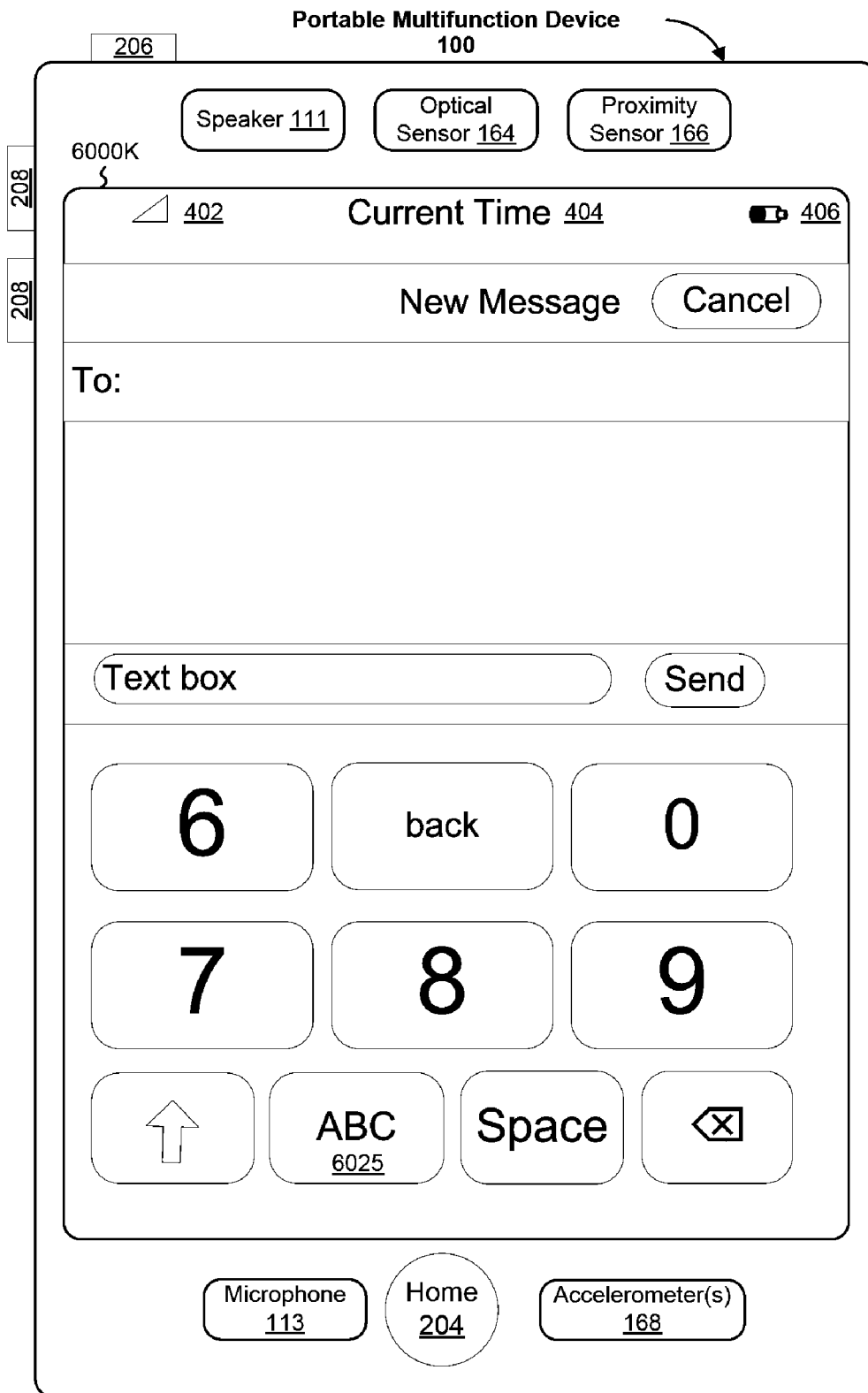

Figure 60K



Figure 60L

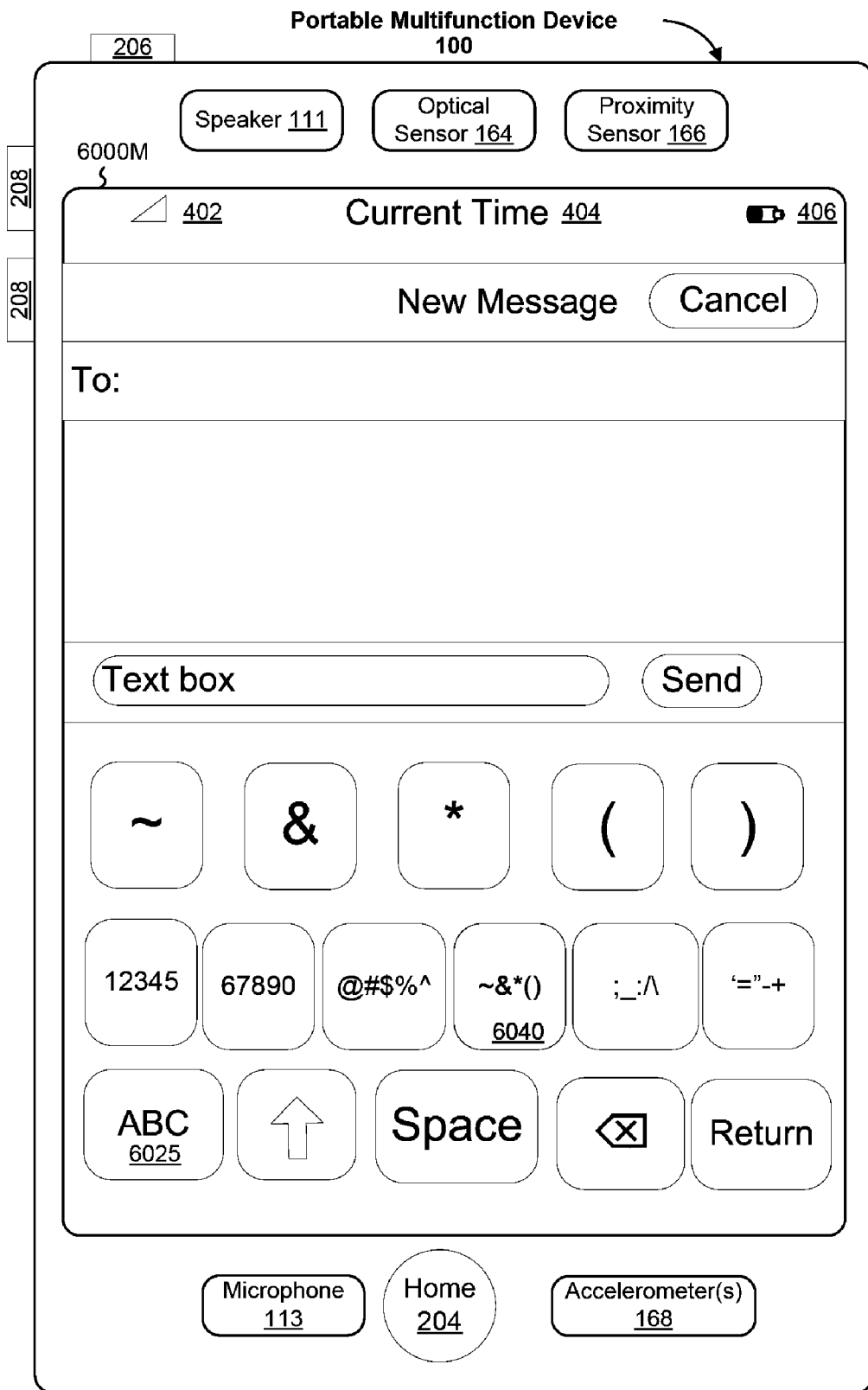

Figure 60M

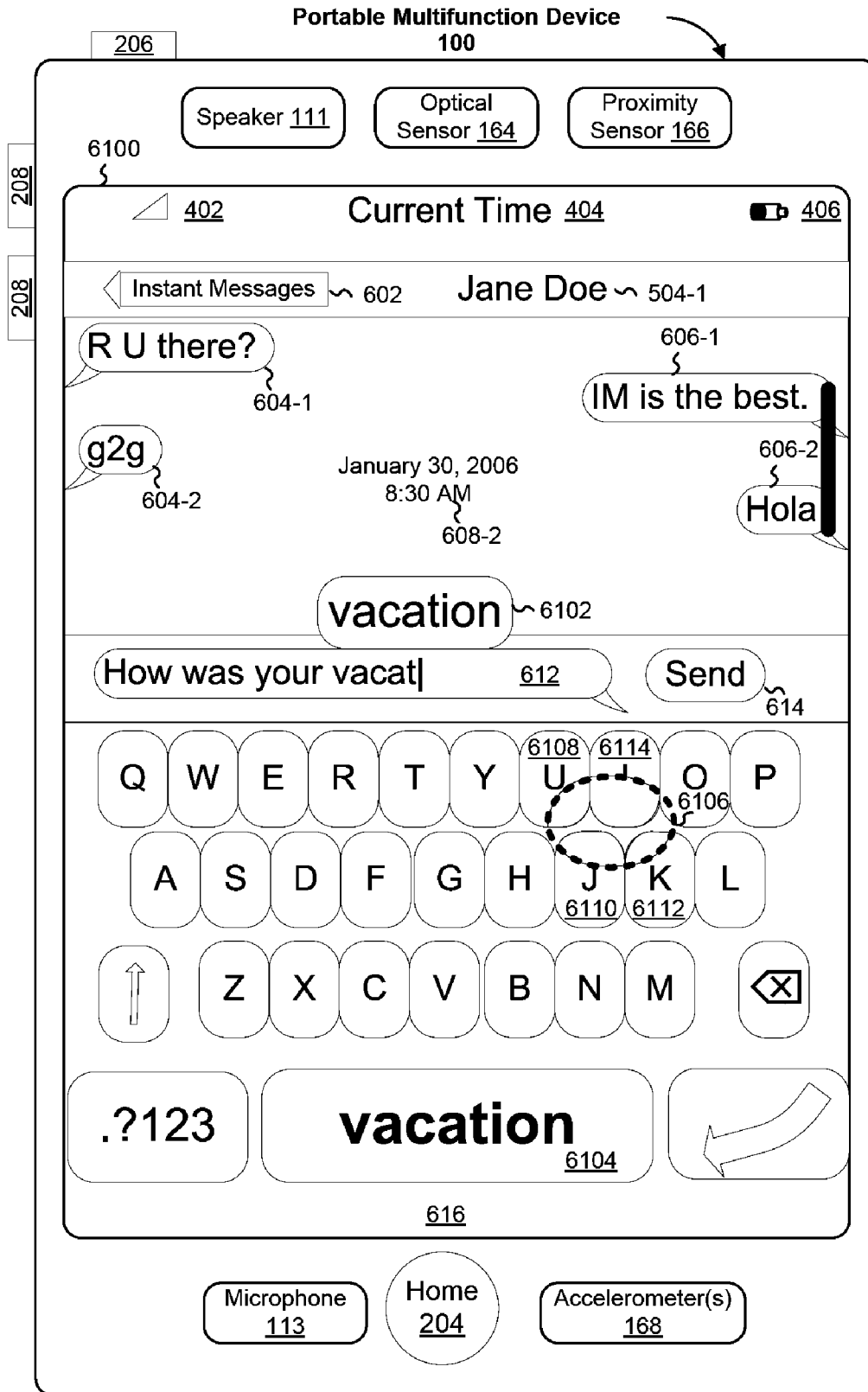

Figure 61

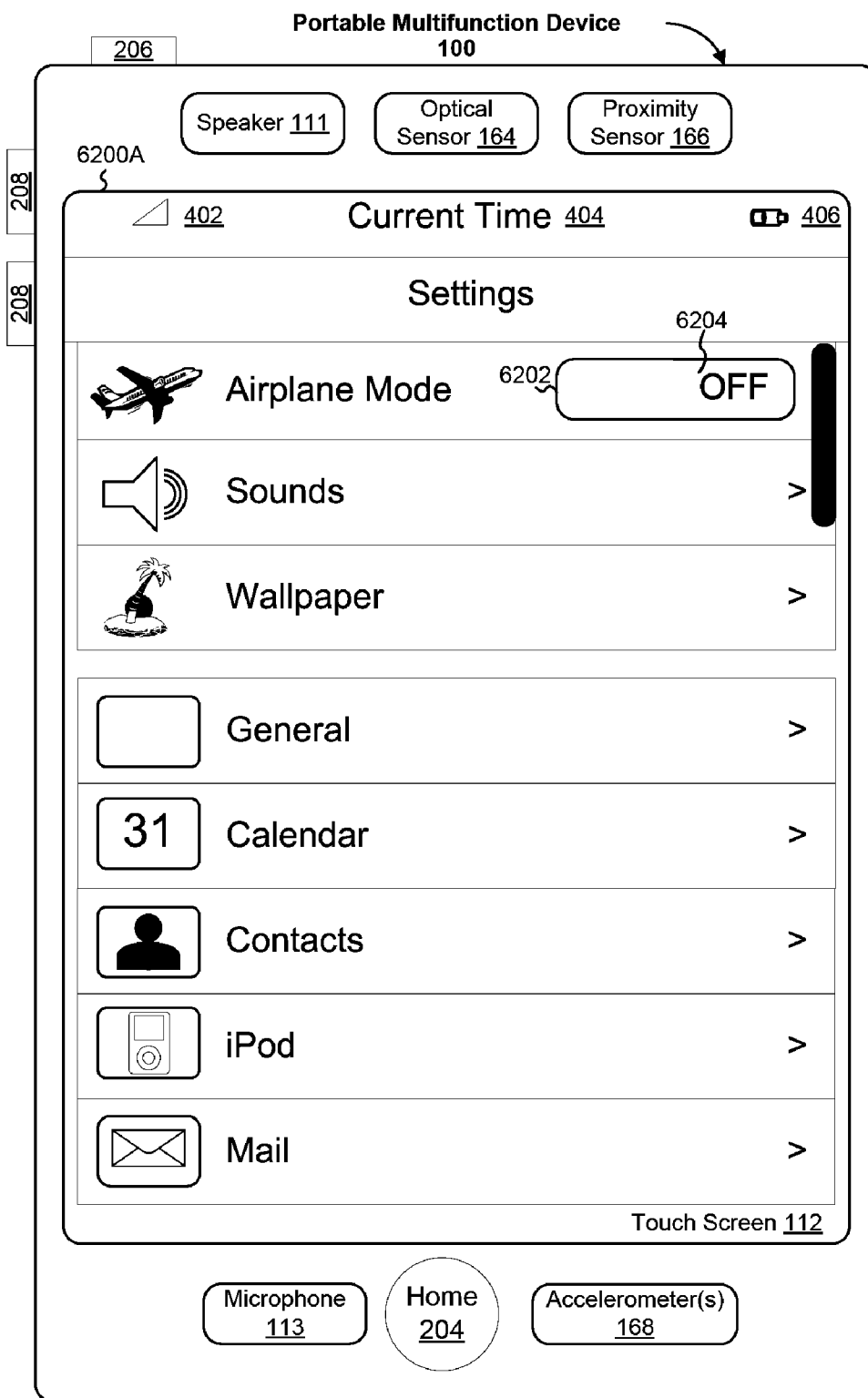

Figure 62A

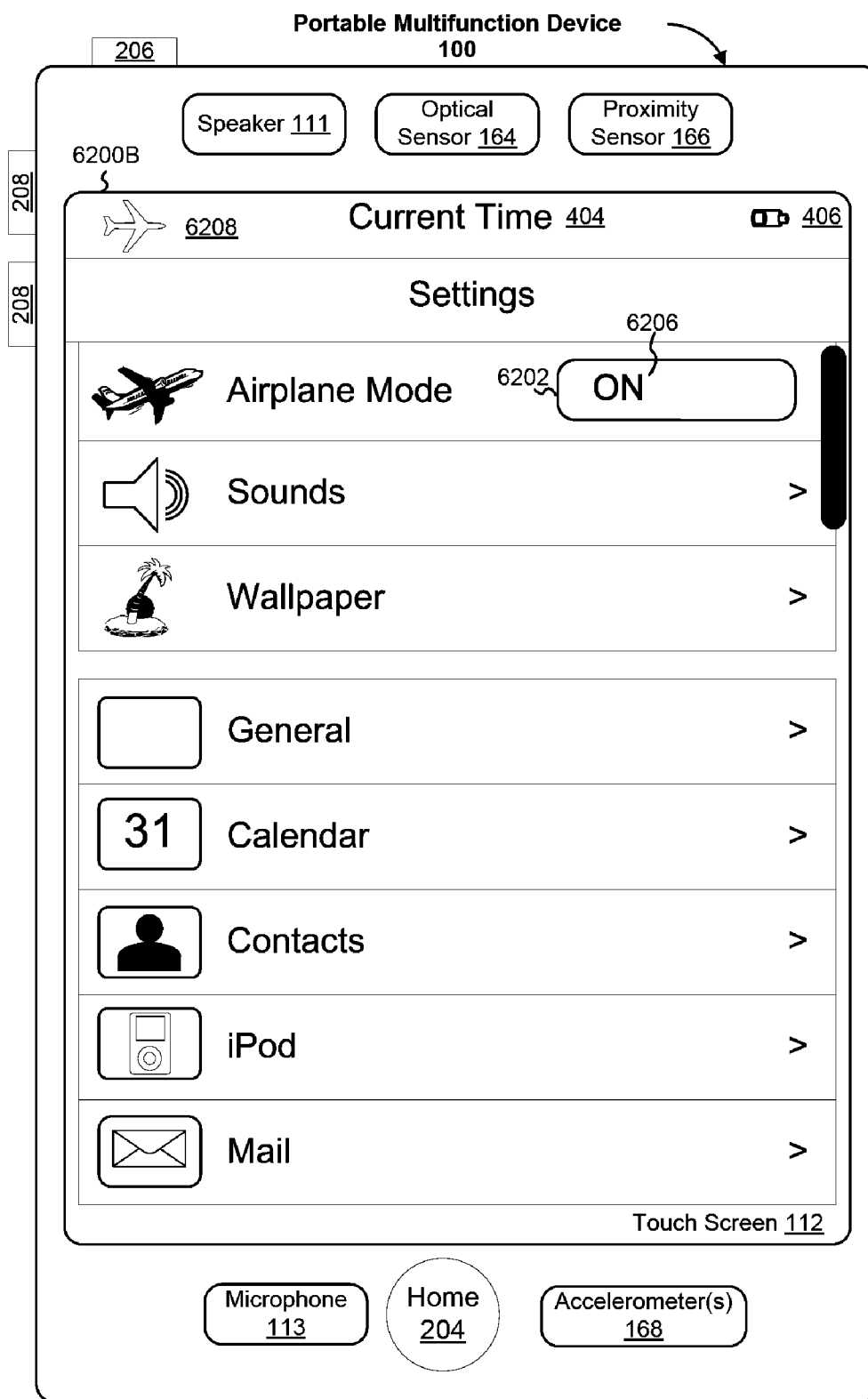

Figure 62B

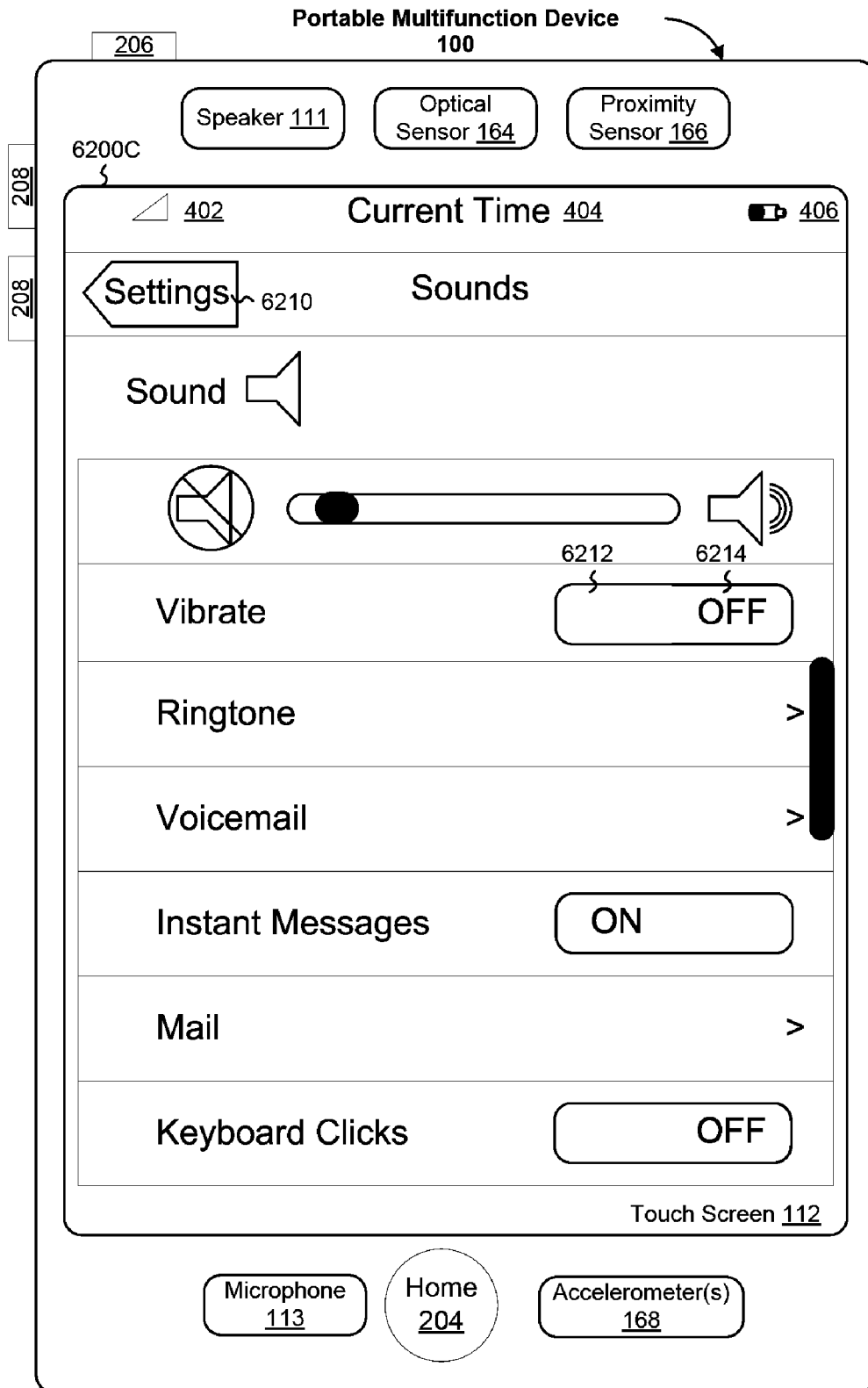

Figure 62C

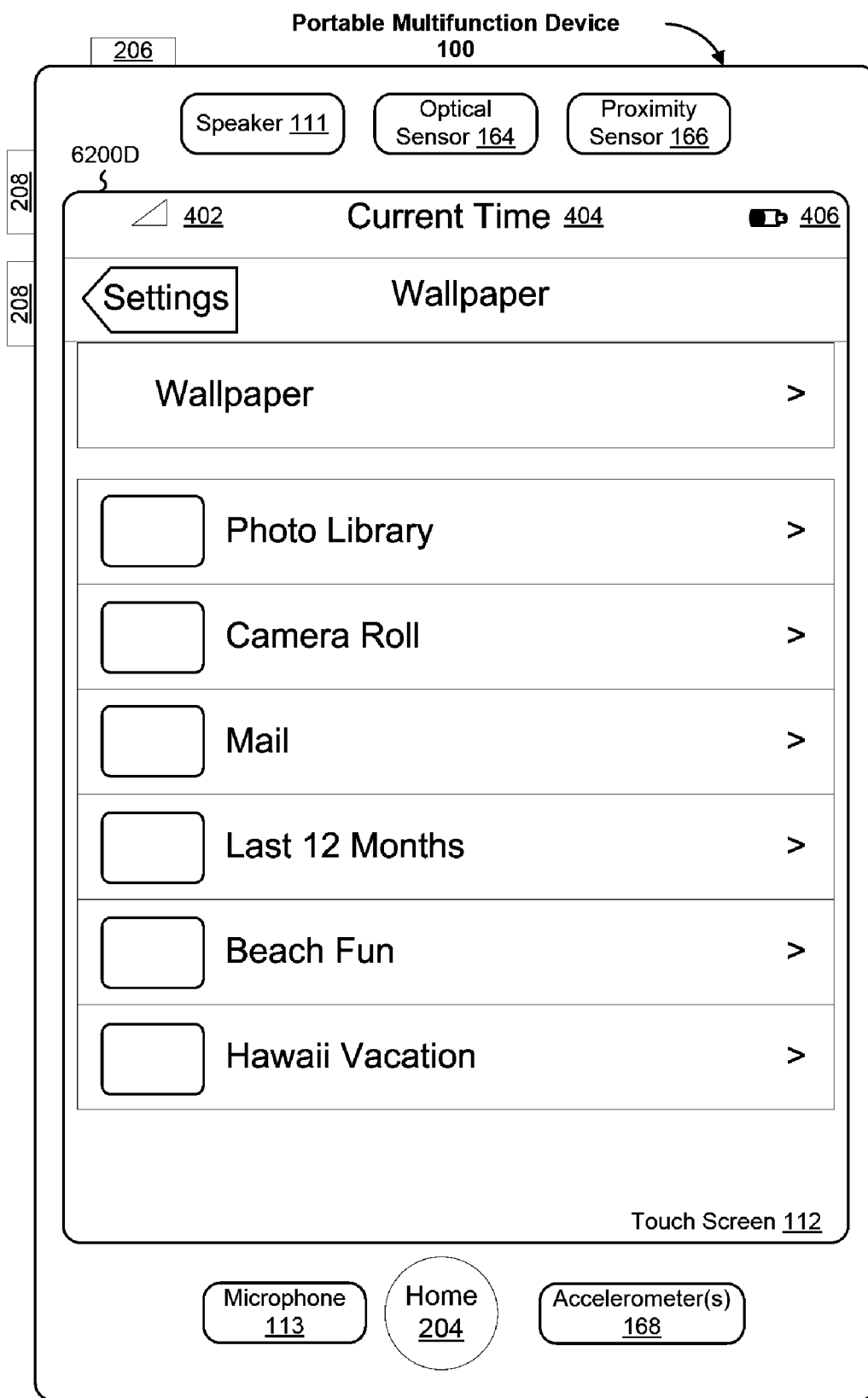

Figure 62D

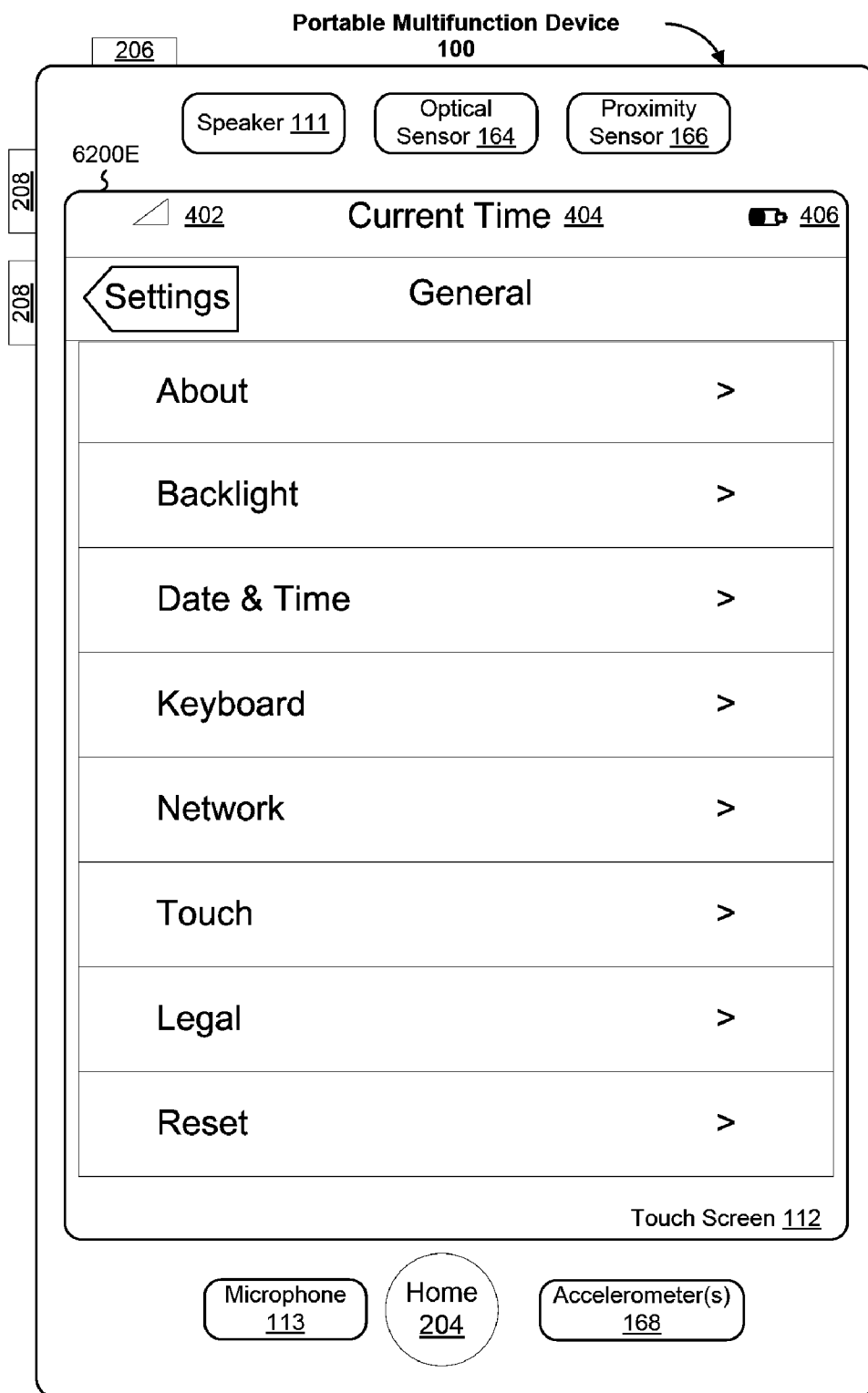

Figure 62E

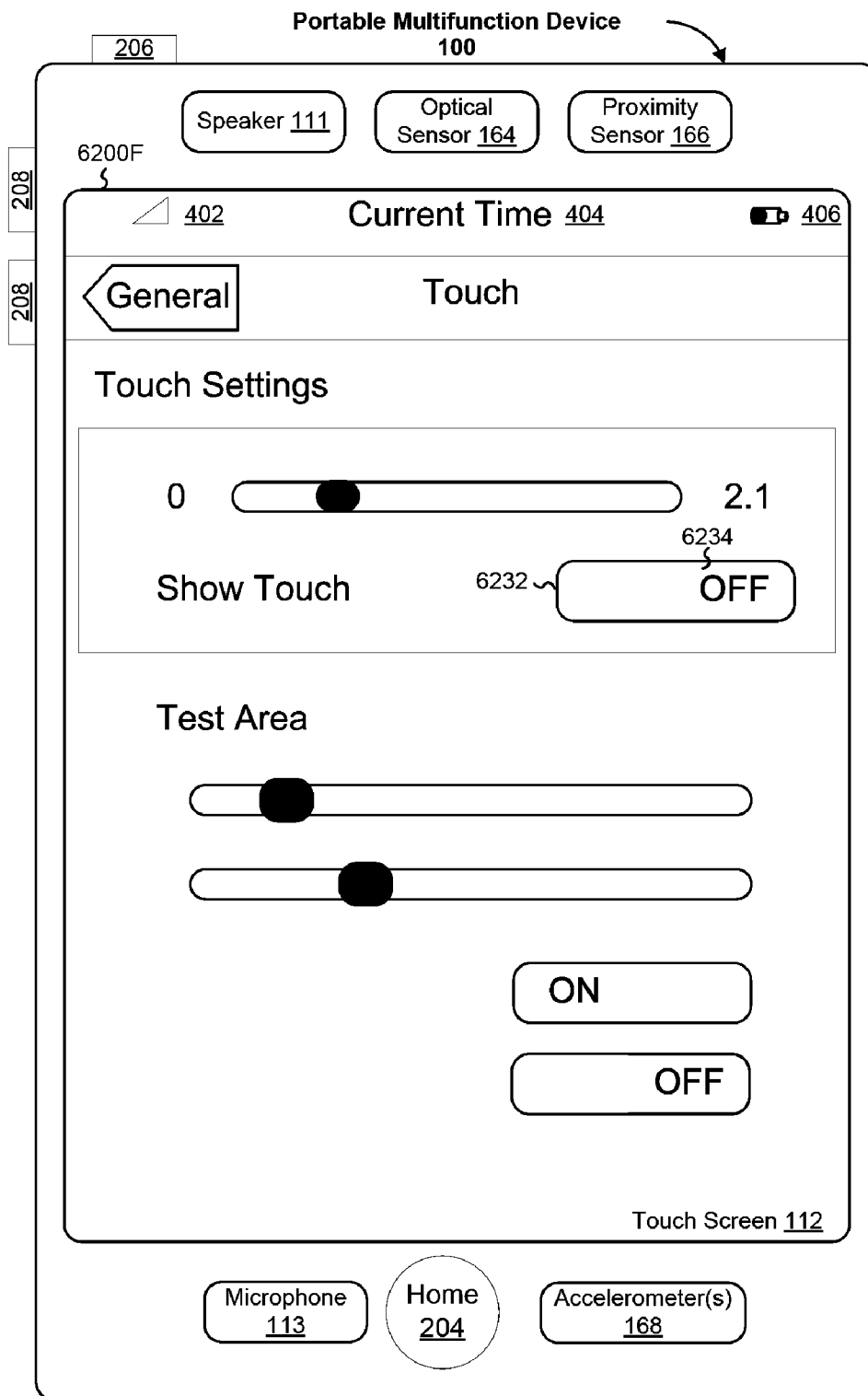

Figure 62F

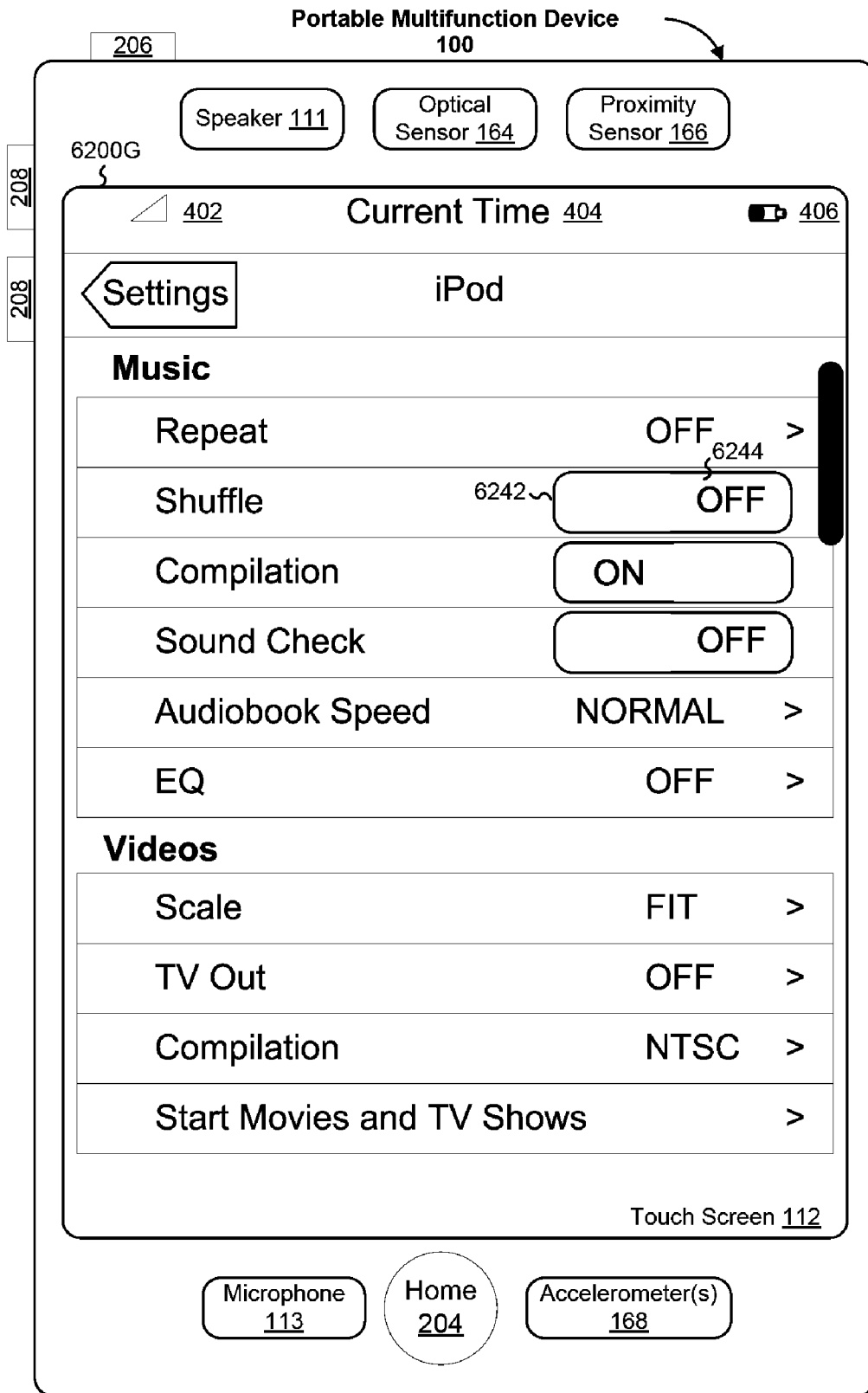

Figure 62G

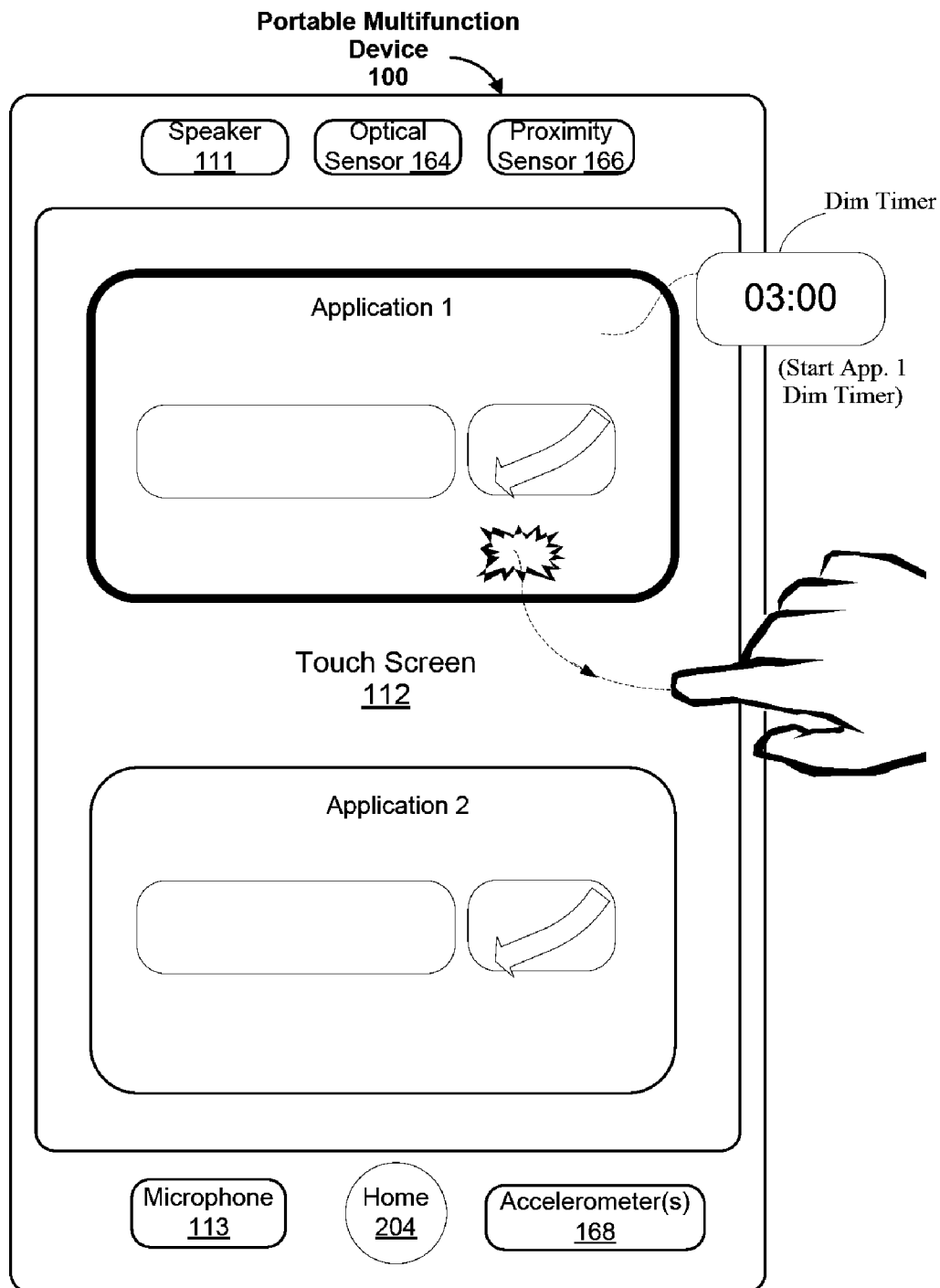

Figure 63

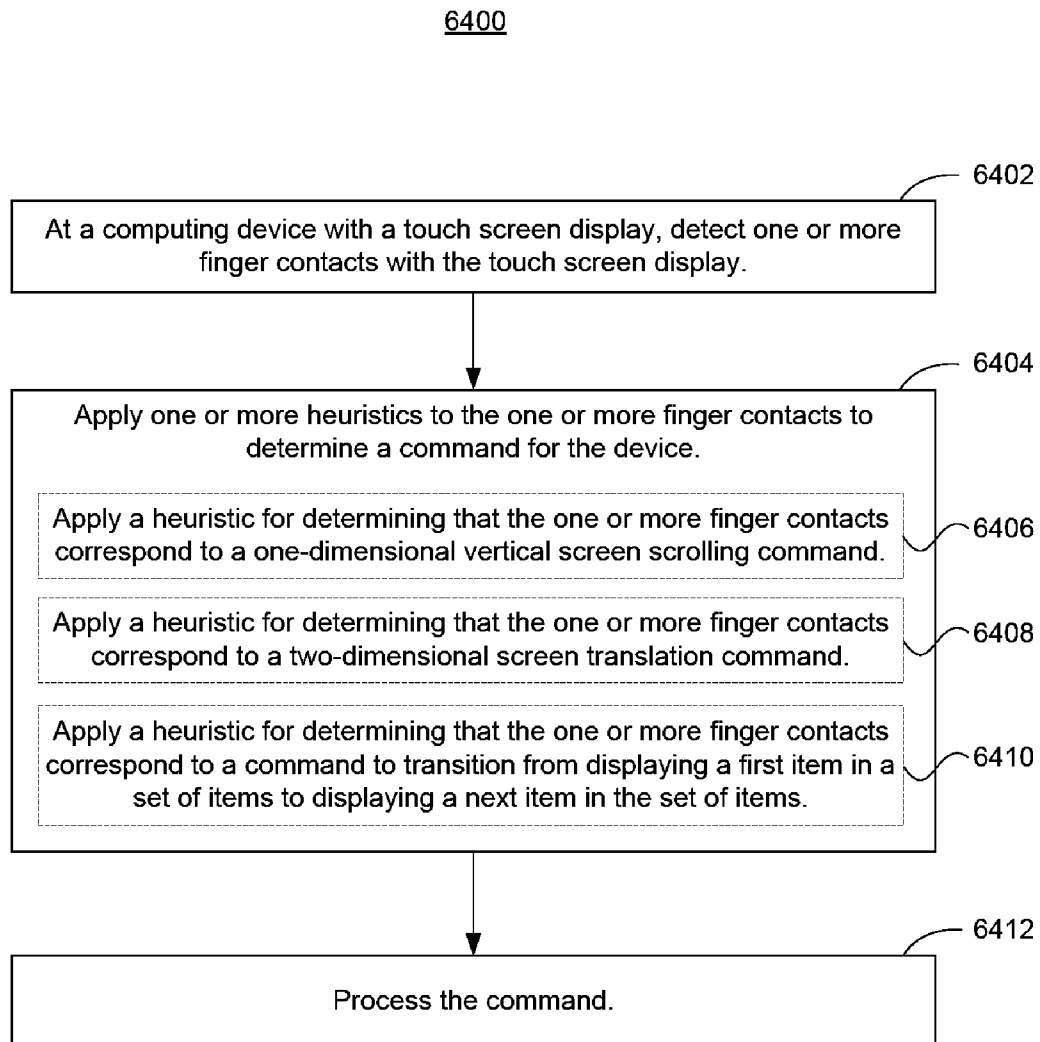

Figure 64A

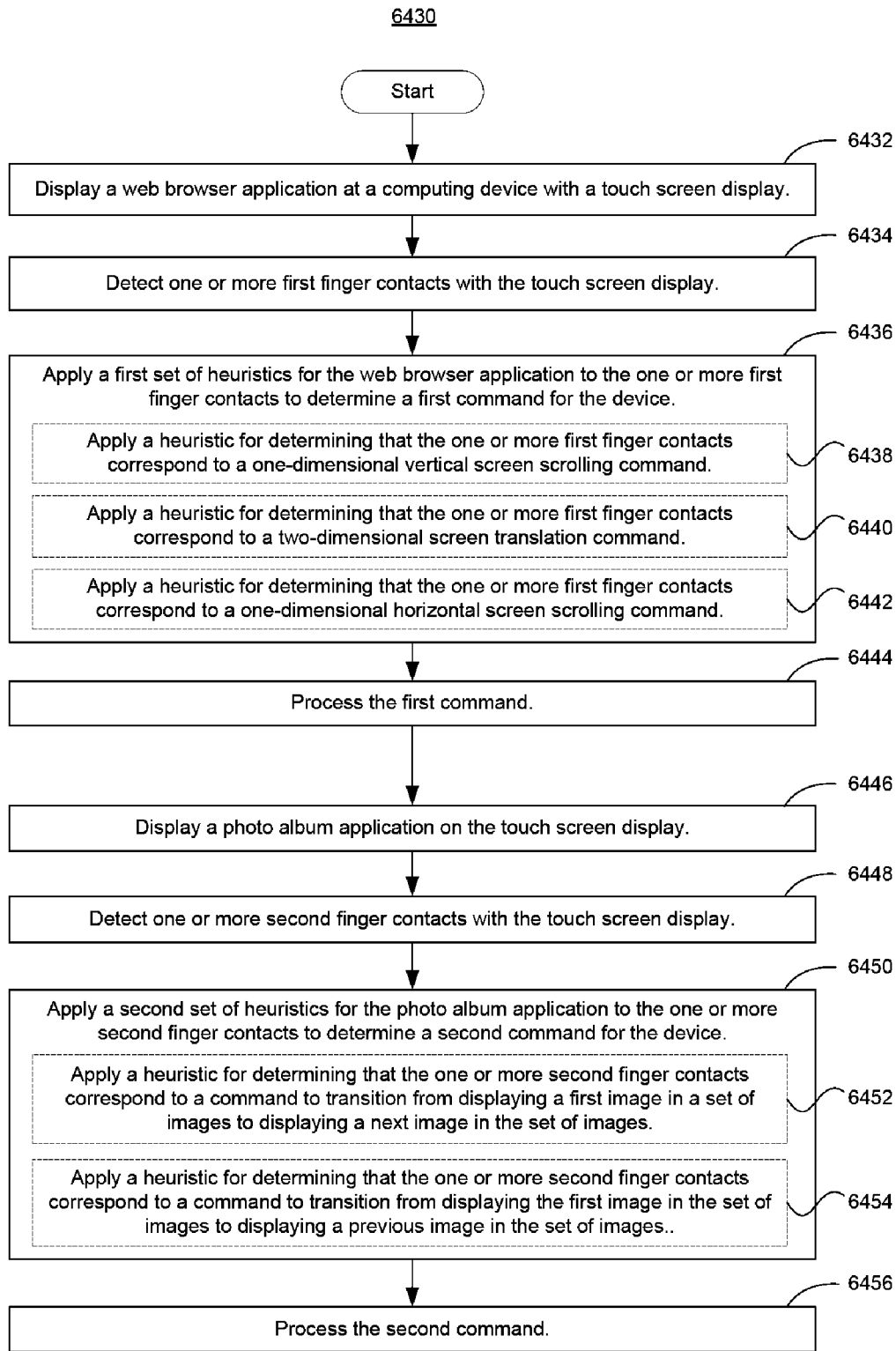

Figure 64B

US 7,479,949 B2

1

**TOUCH SCREEN DEVICE, METHOD, AND
GRAPHICAL USER INTERFACE FOR
DETERMINING COMMANDS BY APPLYING
HEURISTICS**

RELATED APPLICATIONS

This application is a continuation of U.S. patent application Ser. No. 11/850,635, "Touch Screen Device, Method, and Graphical User Interface for Determining Commands by Applying Heuristics," filed Sep. 5, 2007, which claims the benefit of U.S. Provisional Patent Application Nos. 60/937,991, "Touch Screen Device, Method, and Graphical User Interface for Determining Commands by Applying Heuristics," filed Jun. 29, 2007; 60/937,993, "Portable Multifunction Device," filed Jun. 29, 2007; 60/879,469, "Portable Multifunction Device," filed Jan. 8, 2007; 60/879,253, "Portable Multifunction Device," filed Jan. 7, 2007; and 60/824,769, "Portable Multifunction Device," filed Sep. 6, 2006. All of these applications are incorporated by referenced herein in their entirety.

This application is related to the following applications: (1) U.S. patent application Ser. No. 10/188,182, "Touch Pad For Handheld Device," filed Jul. 1, 2002; (2) U.S. patent application Ser. No. 10/722,948, "Touch Pad For Handheld Device," filed Nov. 25, 2003; (3) U.S. patent application Ser. No. 10/643,256, "Movable Touch Pad With Added Functionality," filed Aug. 18, 2003; (4) U.S. patent application Ser. No. 10/654,108, "Ambidextrous Mouse," filed Sep. 2, 2003; (5) U.S. patent application Ser. No. 10/840,862, "Multipoint Touchscreen," filed May 6, 2004; (6) U.S. patent application Ser. No. 10/903,964, "Gestures For Touch Sensitive Input Devices," filed Jul. 30, 2004; (7) U.S. patent application Ser. No. 11/038,590, "Mode-Based Graphical User Interfaces For Touch Sensitive Input Devices" filed Jan. 18, 2005; (8) U.S. patent application Ser. No. 11/057,050, "Display Actuator," filed Feb. 11, 2005; (9) U.S. Provisional Patent Application No. 60/658,777, "Multi-Functional Hand-Held Device," filed Mar. 4, 2005; (10) U.S. patent application Ser. No. 11/367,749, "Multi-Functional Hand-Held Device," filed Mar. 3, 2006; and (11) U.S. patent application Ser. No. 29/281,695, "Icons, Graphical User Interfaces, and Animated Graphical User Interfaces For a Display Screen or Portion Thereof," filed Jun. 28, 2007. All of these applications are incorporated by reference herein in their entirety.

TECHNICAL FIELD

The disclosed embodiments relate generally to electronic devices with touch screen displays, and more particularly, to electronic devices that apply heuristics to detected user gestures on a touch screen display to determine commands.

BACKGROUND

As portable electronic devices become more compact, and the number of functions performed by a given device increase, it has become a significant challenge to design a user interface that allows users to easily interact with a multifunction device. This challenge is particular significant for handheld portable devices, which have much smaller screens than desktop or laptop computers. This situation is unfortunate because the user interface is the gateway through which users receive not only content but also responses to user actions or behaviors, including user attempts to access a device's features, tools, and functions. Some portable communication devices (e.g., mobile telephones, sometimes called mobile

2

phones, cell phones, cellular telephones, and the like) have resorted to adding more pushbuttons, increasing the density of push buttons, overloading the functions of pushbuttons, or using complex menu systems to allow a user to access, store and manipulate data. These conventional user interfaces often result in complicated key sequences and menu hierarchies that must be memorized by the user.

Many conventional user interfaces, such as those that include physical pushbuttons, are also inflexible. This may prevent a user interface from being configured and/or adapted by either an application running on the portable device or by users. When coupled with the time consuming requirement to memorize multiple key sequences and menu hierarchies, and the difficulty in activating a desired pushbutton, such inflexibility is frustrating to most users.

To avoid problems associated with pushbuttons and complex menu systems, portable electronic devices may use touch screen displays that detect user gestures on the touch screen and translate detected gestures into commands to be performed. However, user gestures may be imprecise; a particular gesture may only roughly correspond to a desired command. Other devices with touch screen displays, such as desktop computers with touch screen displays, also may have difficulties translating imprecise gestures into desired commands.

Accordingly, there is a need for touch-screen-display electronic devices with more transparent and intuitive user interfaces for translating imprecise user gestures into precise, intended commands that are easy to use, configure, and/or adapt. Such interfaces increase the effectiveness, efficiency and user satisfaction with portable multifunction devices.

SUMMARY

The above deficiencies and other problems associated with user interfaces for portable devices and touch screen devices are reduced or eliminated by the disclosed multifunction device. In some embodiments, the device is portable. In some embodiments, the device has a touch-sensitive display (also known as a "touch screen") with a graphical user interface (GUI), one or more processors, memory and one or more modules, programs or sets of instructions stored in the memory for performing multiple functions. In some embodiments, the user interacts with the GUI primarily through finger contacts and gestures on the touch-sensitive display. In some embodiments, the functions may include telephoning, video conferencing, e-mailing, instant messaging, blogging, digital photographing, digital videoing, web browsing, digital music playing, and/or digital video playing. Instructions for performing these functions may be included in a computer readable storage medium or other computer program product configured for execution by one or more processors.

In an aspect of the invention, a computer-implemented method for use in conjunction with a computing device with a touch screen display comprises: detecting one or more finger contacts with the touch screen display, applying one or more heuristics to the one or more finger contacts to determine a command for the device, and processing the command. The one or more heuristics comprise: a heuristic for determining that the one or more finger contacts correspond to a one-dimensional vertical screen scrolling command, a heuristic for determining that the one or more finger contacts correspond to a two-dimensional screen translation command, and a heuristic for determining that the one or more finger contacts correspond to a command to transition from displaying a first item in a set of items to displaying a next item in the set of items.

US 7,479,949 B2

3

In another aspect of the invention, a computer-implemented method is performed at a computing device with a touch screen display. While displaying a web browser application, one or more first finger contacts with the touch screen display are detected; a first set of heuristics for the web browser application is applied to the one or more first finger contacts to determine a first command for the device; and the first command is processed. The first set of heuristics comprises: a heuristic for determining that the one or more first finger contacts correspond to a one-dimensional vertical screen scrolling command; a heuristic for determining that the one or more first finger contacts correspond to a two-dimensional screen translation command; and a heuristic for determining that the one or more first finger contacts correspond to a one-dimensional horizontal screen scrolling command. While displaying a photo album application, one or more second finger contacts with the touch screen display are detected; a second set of heuristics for the photo album application is applied to the one or more second finger contacts to determine a second command for the device; and the second command is processed. The second set of heuristics comprises: a heuristic for determining that the one or more second finger contacts correspond to a command to transition from displaying a first image in a set of images to displaying a next image in the set of images; and a heuristic for determining that the one or more second finger contacts correspond to a command to transition from displaying the first image in the set of images to displaying a previous image in the set of images.

In another aspect of the invention, a computing device comprises: a touch screen display, one or more processors, memory, and a program. The program is stored in the memory and configured to be executed by the one or more processors. The program includes: instructions for detecting one or more finger contacts with the touch screen display, instructions for applying one or more heuristics to the one or more finger contacts to determine a command for the device, and instructions for processing the command. The one or more heuristics comprise: a heuristic for determining that the one or more finger contacts correspond to a one-dimensional vertical screen scrolling command, a heuristic for determining that the one or more finger contacts correspond to a two-dimensional screen translation command, and a heuristic for determining that the one or more finger contacts correspond to a command to transition from displaying a first item in a set of items to displaying a next item in the set of items.

In another aspect of the invention, a computing device comprises: a touch screen display; one or more processors; memory; and one or more programs. The one or more programs are stored in the memory and configured to be executed by the one or more processors. The one or more programs include: instructions for detecting one or more first finger contacts with the touch screen display while displaying a web browser application; instructions for applying a first set of heuristics for the web browser application to the one or more first finger contacts to determine a first command for the device; instructions for processing the first command; instructions for detecting one or more second finger contacts with the touch screen display while displaying a photo album application; instructions for applying a second set of heuristics for the photo album application to the one or more second finger contacts to determine a second command for the device; and instructions for processing the second command. The first set of heuristics comprises: a heuristic for determining that the one or more first finger contacts correspond to a one-dimensional vertical screen scrolling command; a heuristic for determining that the one or more first finger contacts correspond to a two-dimensional screen translation com-

4

mand; and a heuristic for determining that the one or more first finger contacts correspond to a one-dimensional horizontal screen scrolling command. The second set of heuristics comprises: a heuristic for determining that the one or more second finger contacts correspond to a command to transition from displaying a first image in a set of images to displaying a next image in the set of images; and a heuristic for determining that the one or more second finger contacts correspond to a command to transition from displaying the first image in the set of images to displaying a previous image in the set of images.

In another aspect of the invention, a computer-program product comprises a computer readable storage medium and a computer program mechanism (e.g., one or more computer programs) embedded therein. The computer program mechanism comprises instructions, which when executed by a computing device with a touch screen display, cause the device to: detect one or more finger contacts with the touch screen display, apply one or more heuristics to the one or more finger contacts to determine a command for the device, and process the command. The one or more heuristics comprise: a heuristic for determining that the one or more finger contacts correspond to a one-dimensional vertical screen scrolling command, a heuristic for determining that the one or more finger contacts correspond to a two-dimensional screen translation command, and a heuristic for determining that the one or more finger contacts correspond to a command to transition from displaying a first item in a set of items to displaying a next item in the set of items.

In another aspect of the invention, a computer-program product comprises a computer readable storage medium and a computer program mechanism (e.g., one or more computer programs) embedded therein. The computer program mechanism comprises instructions, which when executed by a computing device with a touch screen display, cause the device to: detect one or more first finger contacts with the touch screen display while displaying a web browser application; apply a first set of heuristics for the web browser application to the one or more first finger contacts to determine a first command for the device; process the first command; detect one or more second finger contacts with the touch screen display while displaying a photo album application; apply a second set of heuristics for the photo album application to the one or more second finger contacts to determine a second command for the device; and process the second command. The first set of heuristics comprises: a heuristic for determining that the one or more first finger contacts correspond to a one-dimensional vertical screen scrolling command; a heuristic for determining that the one or more first finger contacts correspond to a two-dimensional screen translation command; and a heuristic for determining that the one or more first finger contacts correspond to a one-dimensional horizontal screen scrolling command. The second set of heuristics comprises: a heuristic for determining that the one or more second finger contacts correspond to a command to transition from displaying a first image in a set of images to displaying a next image in the set of images; and a heuristic for determining that the one or more second finger contacts correspond to a command to transition from displaying the first image in the set of images to displaying a previous image in the set of images.

In another aspect of the invention, a computing device with a touch screen display comprises: means for detecting one or more finger contacts with the touch screen display, means for applying one or more heuristics to the one or more finger contacts to determine a command for the device, and means for processing the command. The one or more heuristics comprise: a heuristic for determining that the one or more

US 7,479,949 B2

5

finger contacts correspond to a one-dimensional vertical screen scrolling command, a heuristic for determining that the one or more finger contacts correspond to a two-dimensional screen translation command, and a heuristic for determining that the one or more finger contacts correspond to a command to transition from displaying a first item in a set of items to displaying a next item in the set of items.

In another aspect of the invention, a computing device with a touch screen display comprises: means for detecting one or more first finger contacts with the touch screen display while displaying a web browser application; means for applying a first set of heuristics for the web browser application to the one or more first finger contacts to determine a first command for the device; means for processing the first command; means for detecting one or more second finger contacts with the touch screen display while displaying a photo album application; means for applying a second set of heuristics for the photo album application to the one or more second finger contacts to determine a second command for the device; and means for processing the second command. The first set of heuristics comprises: a heuristic for determining that the one or more first finger contacts correspond to a one-dimensional vertical screen scrolling command; a heuristic for determining that the one or more first finger contacts correspond to a two-dimensional screen translation command; and a heuristic for determining that the one or more first finger contacts correspond to a one-dimensional horizontal screen scrolling command. The second set of heuristics comprises: a heuristic for determining that the one or more second finger contacts correspond to a command to transition from displaying a first image in a set of images to displaying a next image in the set of images; and a heuristic for determining that the one or more second finger contacts correspond to a command to transition from displaying the first image in the set of images to displaying a previous image in the set of images.

The disclosed heuristics allow electronic devices with touch screen displays to behave in a manner desired by the user despite inaccurate input by the user.

BRIEF DESCRIPTION OF THE DRAWINGS

For a better understanding of the aforementioned embodiments of the invention as well as additional embodiments thereof, reference should be made to the Description of Embodiments below, in conjunction with the following drawings in which like reference numerals refer to corresponding parts throughout the figures.

FIGS. 1A and 1B are block diagrams illustrating portable multifunction devices with touch-sensitive displays in accordance with some embodiments.

FIG. 2 illustrates a portable multifunction device having a touch screen in accordance with some embodiments.

FIGS. 3A-3C illustrate exemplary user interfaces for unlocking a portable electronic device in accordance with some embodiments.

FIGS. 4A and 4B illustrate exemplary user interfaces for a menu of applications on a portable multifunction device in accordance with some embodiments.

FIG. 5 illustrates an exemplary user interface for listing instant message conversations on a portable multifunction device in accordance with some embodiments.

FIGS. 6A-6K illustrate an exemplary user interface for inputting text for an instant message in accordance with some embodiments.

FIG. 7 illustrates an exemplary user interface for deleting an instant message conversation in accordance with some

6

FIGS. 8A and 8B illustrate an exemplary user interface for a contact list in accordance with some embodiments.

FIG. 9 illustrates an exemplary user interface for entering a phone number for instant messaging in accordance with some embodiments.

FIG. 10 illustrates an exemplary user interface for a camera in accordance with some embodiments.

FIG. 11 illustrates an exemplary user interface for a camera roll in accordance with some embodiments.

FIGS. 12A-12C illustrate an exemplary user interface for viewing and manipulating acquired images in accordance with some embodiments.

FIGS. 13A and 13B illustrate exemplary user interfaces for viewing albums in accordance with some embodiments.

FIG. 14 illustrates an exemplary user interface for setting user preferences in accordance with some embodiments.

FIG. 15 illustrates an exemplary user interface for viewing an album in accordance with some embodiments.

FIGS. 16A and 16B illustrate exemplary user interfaces for viewing images in an album in accordance with some embodiments.

FIG. 17 illustrates an exemplary user interface for selecting a use for an image in an album in accordance with some embodiments.

FIGS. 18A-18J illustrate an exemplary user interface for incorporating an image in an email in accordance with some embodiments.

FIGS. 19A and 19B illustrate an exemplary user interface for assigning an image to a contact in the user's contact list in accordance with some embodiments.

FIG. 20 illustrates an exemplary user interface for incorporating an image in the user's wallpaper in accordance with some embodiments.

FIGS. 21A-21C illustrate an exemplary user interface for organizing and managing videos in accordance with some embodiments.

FIGS. 22A and 22B illustrate an exemplary user interface for setting user preferences for a video player in accordance with some embodiments.

FIGS. 23A-23D illustrate exemplary user interfaces for a video player in accordance with some embodiments.

FIGS. 24A-24E illustrate an exemplary user interface for displaying and managing a weather widget in accordance with some embodiments.

FIGS. 25A-25E illustrate an exemplary user interface for displaying and managing a stocks widget in accordance with some embodiments.

FIGS. 26A-26P illustrate an exemplary user interface for displaying and managing contacts in accordance with some embodiments.

FIGS. 27A-27F illustrate an exemplary user interface for displaying and managing favorite contacts in accordance with some embodiments.

FIGS. 28A-28D illustrate an exemplary user interface for displaying and managing recent calls in accordance with some embodiments.

FIG. 29 illustrates an exemplary dial pad interface for calling in accordance with some embodiments.

FIGS. 30A-30R illustrate exemplary user interfaces displayed during a call in accordance with some embodiments.

FIGS. 31A and 31B illustrate an exemplary user interface displayed during an incoming call in accordance with some

embodiments.

FIGS. 32A-32H illustrate exemplary user interfaces for voicemail in accordance with some embodiments.

US 7,479,949 B2

7

FIG. 33 illustrates an exemplary user interface for organizing and managing email in accordance with some embodiments.

FIGS. 34A-34C illustrate an exemplary user interface for creating emails in accordance with some embodiments.

FIGS. 35A-35O illustrate exemplary user interfaces for displaying and managing an inbox in accordance with some embodiments.

FIG. 36 illustrates an exemplary user interface for setting email user preferences in accordance with some embodiments.

FIGS. 37A and 37B illustrate an exemplary user interface for creating and managing email rules in accordance with some embodiments.

FIGS. 38A and 38B illustrate an exemplary user interface for moving email messages in accordance with some embodiments.

FIGS. 39A-39M illustrate exemplary user interfaces for a browser in accordance with some embodiments.

FIGS. 40A-40F illustrate exemplary user interfaces for playing an item of inline multimedia content in accordance with some embodiments.

FIGS. 41A-41E illustrate exemplary user interfaces for interacting with user input elements in displayed content in accordance with some embodiments.

FIG. 41F illustrates an exemplary user interface for interacting with hyperlinks in displayed content in accordance with some embodiments.

FIGS. 42A-42C illustrate exemplary user interfaces for translating page content or translating just frame content within the page content in accordance with some embodiments.

FIGS. 43A-43DD illustrate exemplary user interfaces for a music and video player in accordance with some embodiments.

FIGS. 44A-44J illustrate portrait-landscape rotation heuristics in accordance with some embodiments.

FIGS. 45A-45G are graphical user interfaces illustrating an adaptive approach for presenting information on the touch screen display in accordance with some embodiments.

FIGS. 46A-46C illustrate digital artwork created for a content file based on metadata associated with the content file in accordance with some embodiments.

FIGS. 47A-47E illustrate exemplary methods for moving a slider icon in accordance with some embodiments.

FIGS. 48A-48C illustrate an exemplary user interface for managing, displaying, and creating notes in accordance with some embodiments.

FIGS. 49A-49N illustrate exemplary user interfaces for a calendar in accordance with some embodiments.

FIGS. 50A-50I illustrate exemplary user interfaces for a clock in accordance with some embodiments.

FIGS. 51A-51B illustrate exemplary user interfaces for creating a widget in accordance with some embodiments.

FIGS. 52A-52H illustrate exemplary user interfaces for a map application in accordance with some embodiments.

FIGS. 53A-53D illustrate exemplary user interfaces for displaying notification information for missed communications in accordance with some embodiments.

FIG. 54 illustrates a method for silencing a portable device in accordance with some embodiments.

FIGS. 55A-55D illustrate a method for turning off a portable device in accordance with some embodiments.

FIGS. 56A-56L illustrate exemplary methods for determining a cursor position on a touch screen display in accordance with some embodiments.

8

FIGS. 56M-56O illustrate an exemplary method for dynamically adjusting numbers associated with soft keyboard keys as a word is typed with the soft keyboard keys in accordance with some embodiments.

FIGS. 57A-57C illustrate an exemplary screen rotation gesture in accordance with some embodiments.

FIGS. 58A-58D illustrate an approach of identifying a user-desired user interface object when a finger contact's corresponding cursor position falls into an overlapping hit region in accordance with some embodiments.

FIGS. 59A-59E illustrate how a finger tap gesture activates a soft key icon on a touch screen display in accordance with some embodiments.

FIGS. 59F-59H illustrate how a finger swipe gesture controls a slide control icon on a touch screen display in accordance with some embodiments.

FIGS. 60A-60M illustrate exemplary soft keyboards in accordance with some embodiments.

FIG. 61 illustrates an exemplary finger contact with a soft keyboard in accordance with some embodiments.

FIGS. 62A-62G illustrate exemplary user interfaces for displaying and adjusting settings in accordance with some embodiments.

FIG. 63 illustrates an exemplary method for adjusting dimming timers in accordance with some embodiments.

FIGS. 64A and 64B are flow diagrams illustrating methods of applying heuristics in accordance with some embodiments.

DESCRIPTION OF EMBODIMENTS

Reference will now be made in detail to embodiments, examples of which are illustrated in the accompanying drawings. In the following detailed description, numerous specific details are set forth in order to provide a thorough understanding of the present invention. However, it will be apparent to one of ordinary skill in the art that the present invention may be practiced without these specific details. In other instances, well-known methods, procedures, components, circuits, and networks have not been described in detail so as not to unnecessarily obscure aspects of the embodiments.

It will also be understood that, although the terms first, second, etc. may be used herein to describe various elements, these elements should not be limited by these terms. These terms are only used to distinguish one element from another. For example, a first gesture could be termed a second gesture, and, similarly, a second gesture could be termed a first gesture, without departing from the scope of the present invention.

The terminology used in the description of the invention herein is for the purpose of describing particular embodiments only and is not intended to be limiting of the invention. As used in the description of the invention and the appended claims, the singular forms "a", "an" and "the" are intended to include the plural forms as well, unless the context clearly indicates otherwise. It will also be understood that the term "and/or" as used herein refers to and encompasses any and all possible combinations of one or more of the associated listed items. It will be further understood that the terms "comprises" and/or "comprising," when used in this specification, specify the presence of stated features, integers, steps, operations, elements, and/or components, but do not preclude the presence or addition of one or more other features, integers, steps, operations, elements, components, and/or groups thereof.

As used herein, the term "if" may be construed to mean "when" or "upon" or "in response to determining" or "in response to detecting," depending on the context. Similarly,

the phrase “if it is determined” or “if [a stated condition or event] is detected” may be construed to mean “upon determining” or “in response to determining” or “upon detecting [the stated condition or event]” or “in response to detecting [the stated condition or event],” depending on the context.

Embodiments of a portable multifunction device, user interfaces for such devices, and associated processes for using such devices are described. In some embodiments, the device is a portable communications device such as a mobile telephone that also contains other functions, such as PDA and/or music player functions.

The user interface may include a physical click wheel in addition to a touch screen or a virtual click wheel displayed on the touch screen. A click wheel is a user-interface device that may provide navigation commands based on an angular displacement of the wheel or a point of contact with the wheel by a user of the device. A click wheel may also be used to provide a user command corresponding to selection of one or more items, for example, when the user of the device presses down on at least a portion of the wheel or the center of the wheel. Alternatively, breaking contact with a click wheel image on a touch screen surface may indicate a user command corresponding to selection. For simplicity, in the discussion that follows, a portable multifunction device that includes a touch screen is used as an exemplary embodiment. It should be understood, however, that some of the user interfaces and associated processes may be applied to other devices, such as personal computers and laptop computers, which may include one or more other physical user-interface devices, such as a physical click wheel, a physical keyboard, a mouse and/or a joystick.

The device supports a variety of applications, such as one or more of the following: a telephone application, a video conferencing application, an e-mail application, an instant messaging application, a blogging application, a photo management application, a digital camera application, a digital video camera application, a web browsing application, a digital music player application, and/or a digital video player application.

The various applications that may be executed on the device may use at least one common physical user-interface device, such as the touch screen. One or more functions of the touch screen as well as corresponding information displayed on the device may be adjusted and/or varied from one application to the next and/or within a respective application. In this way, a common physical architecture (such as the touch screen) of the device may support the variety of applications with user interfaces that are intuitive and transparent.

The user interfaces may include one or more soft keyboard embodiments. The soft keyboard embodiments may include standard (QWERTY) and/or non-standard configurations of symbols on the displayed icons of the keyboard, such as those described in U.S. patent application Ser. Nos. 11/459,606, “Keyboards For Portable Electronic Devices,” filed Jul. 24, 2006, and 11/459,615, “Touch Screen Keyboards For Portable Electronic Devices,” filed Jul. 24, 2006, the contents of which are hereby incorporated by reference in their entirety. The keyboard embodiments may include a reduced number of icons (or soft keys) relative to the number of keys in existing physical keyboards, such as that for a typewriter. This may make it easier for users to select one or more icons in the keyboard, and thus, one or more corresponding symbols. The keyboard embodiments may be adaptive. For example, displayed icons may be modified in accordance with user actions, such as selecting one or more icons and/or one or more corresponding symbols. One or more applications on the portable device may utilize common and/or different key-

board embodiments. Thus, the keyboard embodiment used may be tailored to at least some of the applications. In some embodiments, one or more keyboard embodiments may be tailored to a respective user. For example, one or more keyboard embodiments may be tailored to a respective user based on a word usage history (lexicography, slang, individual usage) of the respective user. Some of the keyboard embodiments may be adjusted to reduce a probability of a user error when selecting one or more icons, and thus one or more symbols, when using the soft keyboard embodiments.

Attention is now directed towards embodiments of the device. FIGS. 1A and 1B are block diagrams illustrating portable multifunction devices **100** with touch-sensitive displays **112** in accordance with some embodiments. The touch-sensitive display **112** is sometimes called a “touch screen” for convenience, and may also be known as or called a touch-sensitive display system. The device **100** may include a memory **102** (which may include one or more computer readable storage mediums), a memory controller **122**, one or more processing units (CPU’s) **120**, a peripherals interface **118**, RF circuitry **108**, audio circuitry **110**, a speaker **111**, a microphone **113**, an input/output (I/O) subsystem **106**, other input or control devices **116**, and an external port **124**. The device **100** may include one or more optical sensors **164**. These components may communicate over one or more communication buses or signal lines **103**.

It should be appreciated that the device **100** is only one example of a portable multifunction device **100**, and that the device **100** may have more or fewer components than shown, may combine two or more components, or a may have a different configuration or arrangement of the components. The various components shown in FIGS. 1A and 1B may be implemented in hardware, software or a combination of both hardware and software, including one or more signal processing and/or application specific integrated circuits.

Memory **102** may include high-speed random access memory and may also include non-volatile memory, such as one or more magnetic disk storage devices, flash memory devices, or other non-volatile solid-state memory devices. Access to memory **102** by other components of the device **100**, such as the CPU **120** and the peripherals interface **118**, may be controlled by the memory controller **122**.

The peripherals interface **118** couples the input and output peripherals of the device to the CPU **120** and memory **102**. The one or more processors **120** run or execute various software programs and/or sets of instructions stored in memory **102** to perform various functions for the device **100** and to process data.

In some embodiments, the peripherals interface **118**, the CPU **120**, and the memory controller **122** may be implemented on a single chip, such as a chip **104**. In some other embodiments, they may be implemented on separate chips.

The RF (radio frequency) circuitry **108** receives and sends RF signals, also called electromagnetic signals. The RF circuitry **108** converts electrical signals to/from electromagnetic signals and communicates with communications networks and other communications devices via the electromagnetic signals. The RF circuitry **108** may include well-known circuitry for performing these functions, including but not limited to an antenna system, an RF transceiver, one or more amplifiers, a tuner, one or more oscillators, a digital signal processor, a CODEC chipset, a subscriber identity module (SIM) card, memory, and so forth. The RF circuitry **108** may communicate with networks, such as the Internet, also referred to as the World Wide Web (WWW), an intranet and/or a wireless network, such as a cellular telephone network, a wireless local area network (LAN) and/or a metro-

US 7,479,949 B2

11

politan area network (MAN), and other devices by wireless communication. The wireless communication may use any of a plurality of communications standards, protocols and technologies, including but not limited to Global System for Mobile Communications (GSM), Enhanced Data GSM Environment (EDGE), high-speed downlink packet access (HSDPA), wideband code division multiple access (W-CDMA), code division multiple access (CDMA), time division multiple access (TDMA), Bluetooth, Wireless Fidelity (Wi-Fi) (e.g., IEEE 802.11a, IEEE 802.11b, IEEE 802.11g and/or IEEE 802.11n), voice over Internet Protocol (VoIP), Wi-MAX, a protocol for email (e.g., Internet message access protocol (IMAP) and/or post office protocol (POP)), instant messaging (e.g., extensible messaging and presence protocol (XMPP), Session Initiation Protocol for Instant Messaging and Presence Leveraging Extensions (SIMPLE), and/or Instant Messaging and Presence Service (IMPS)), and/or Short Message Service (SMS)), or any other suitable communication protocol, including communication protocols not yet developed as of the filing date of this document.

The audio circuitry **110**, the speaker **111**, and the microphone **113** provide an audio interface between a user and the device **100**. The audio circuitry **110** receives audio data from the peripherals interface **118**, converts the audio data to an electrical signal, and transmits the electrical signal to the speaker **111**. The speaker **111** converts the electrical signal to human-audible sound waves. The audio circuitry **110** also receives electrical signals converted by the microphone **113** from sound waves. The audio circuitry **110** converts the electrical signal to audio data and transmits the audio data to the peripherals interface **118** for processing. Audio data may be retrieved from and/or transmitted to memory **102** and/or the RF circuitry **108** by the peripherals interface **118**. In some embodiments, the audio circuitry **110** also includes a headset jack (e.g. **212**, FIG. 2). The headset jack provides an interface between the audio circuitry **110** and removable audio input/output peripherals, such as output-only headphones or a headset with both output (e.g., a headphone for one or both ears) and input (e.g., a microphone).

The I/O subsystem **106** couples input/output peripherals on the device **100**, such as the touch screen **112** and other input/control devices **116**, to the peripherals interface **118**. The I/O subsystem **106** may include a display controller **156** and one or more input controllers **160** for other input or control devices. The one or more input controllers **160** receive/send electrical signals from/to other input or control devices **116**. The other input/control devices **116** may include physical buttons (e.g., push buttons, rocker buttons, etc.), dials, slider switches, joysticks, click wheels, and so forth. In some alternate embodiments, input controller(s) **160** may be coupled to any (or none) of the following: a keyboard, infrared port, USB port, and a pointer device such as a mouse. The one or more buttons (e.g., **208**, FIG. 2) may include an up/down button for volume control of the speaker **111** and/or the microphone **113**. The one or more buttons may include a push button (e.g., **206**, FIG. 2). A quick press of the push button may disengage a lock of the touch screen **112** or begin a process that uses gestures on the touch screen to unlock the device, as described in U.S. patent application Ser. No. 11/322,549, "Unlocking a Device by Performing Gestures on an Unlock Image," filed Dec. 23, 2005, which is hereby incorporated by reference in its entirety. A longer press of the push button (e.g., **206**) may turn power to the device **100** on or off. The user may be able to customize a functionality of one or more of the buttons. The touch screen **112** is used to implement virtual or soft buttons and one or more soft keyboards.

12

The touch-sensitive touch screen **112** provides an input interface and an output interface between the device and a user. The display controller **156** receives and/or sends electrical signals from/to the touch screen **112**. The touch screen **112** displays visual output to the user. The visual output may include graphics, text, icons, video, and any combination thereof (collectively termed "graphics"). In some embodiments, some or all of the visual output may correspond to user-interface objects, further details of which are described below.

A touch screen **112** has a touch-sensitive surface, sensor or set of sensors that accepts input from the user based on haptic and/or tactile contact. The touch screen **112** and the display controller **156** (along with any associated modules and/or sets of instructions in memory **102**) detect contact (and any movement or breaking of the contact) on the touch screen **112** and converts the detected contact into interaction with user-interface objects (e.g., one or more soft keys, icons, web pages or images) that are displayed on the touch screen. In an exemplary embodiment, a point of contact between a touch screen **112** and the user corresponds to a finger of the user.

The touch screen **112** may use LCD (liquid crystal display) technology, or LPD (light emitting polymer display) technology, although other display technologies may be used in other embodiments. The touch screen **112** and the display controller **156** may detect contact and any movement or breaking thereof using any of a plurality of touch sensing technologies now known or later developed, including but not limited to capacitive, resistive, infrared, and surface acoustic wave technologies, as well as other proximity sensor arrays or other elements for determining one or more points of contact with a touch screen **112**.

A touch-sensitive display in some embodiments of the touch screen **112** may be analogous to the multi-touch sensitive tablets described in the following U.S. patents: U.S. Pat. Nos. 6,323,846 (Westerman et al.), 6,570,557 (Westerman et al.), and/or 6,677,932 (Westerman), and/or U.S. Patent Publication 2002/0015024A1, each of which is hereby incorporated by reference in its entirety. However, a touch screen **112** displays visual output from the portable device **100**, whereas touch sensitive tablets do not provide visual output.

A touch-sensitive display in some embodiments of the touch screen **112** may be as described in the following applications: (1) U.S. patent application Ser. No. 11/381,313, "Multipoint Touch Surface Controller," filed May 2, 2006; (2) U.S. patent application Ser. No. 10/840,862, "Multipoint Touchscreen," filed May 6, 2004; (3) U.S. patent application Ser. No. 10/903,964, "Gestures For Touch Sensitive Input Devices," filed Jul. 30, 2004; (4) U.S. patent application Ser. No. 11/048,264, "Gestures For Touch Sensitive Input Devices," filed Jan. 31, 2005; (5) U.S. patent application Ser. No. 11/038,590, "Mode-Based Graphical User Interfaces For Touch Sensitive Input Devices," filed Jan. 18, 2005; (6) U.S. patent application Ser. No. 11/228,758, "Virtual Input Device Placement On A Touch Screen User Interface," filed Sep. 16, 2005; (7) U.S. patent application Ser. No. 11/228,700, "Operation Of A Computer With A Touch Screen Interface," filed Sep. 16, 2005; (8) U.S. patent application Ser. No. 11/228,737, "Activating Virtual Keys Of A Touch-Screen Virtual Keyboard," filed Sep. 16, 2005; and (9) U.S. patent application Ser. No. 11/367,749, "Multi-Functional Hand-Held Device," filed Mar. 3, 2006. All of these applications are incorporated by reference herein in their entirety.

The touch screen **112** may have a resolution in excess of 100 dpi. In an exemplary embodiment, the touch screen has a resolution of approximately 160 dpi. The user may make contact with the touch screen **112** using any suitable object or

US 7,479,949 B2

13

appendage, such as a stylus, a finger, and so forth. In some embodiments, the user interface is designed to work primarily with finger-based contacts and gestures, which are much less precise than stylus-based input due to the larger area of contact of a finger on the touch screen. In some embodiments, the device translates the rough finger-based input into a precise pointer/cursor position or command for performing the actions desired by the user.

In some embodiments, in addition to the touch screen, the device **100** may include a touchpad (not shown) for activating or deactivating particular functions. In some embodiments, the touchpad is a touch-sensitive area of the device that, unlike the touch screen, does not display visual output. The touchpad may be a touch-sensitive surface that is separate from the touch screen **112** or an extension of the touch-sensitive surface formed by the touch screen.

In some embodiments, the device **100** may include a physical or virtual click wheel as an input control device **116**. A user may navigate among and interact with one or more graphical objects (henceforth referred to as icons) displayed in the touch screen **112** by rotating the click wheel or by moving a point of contact with the click wheel (e.g., where the amount of movement of the point of contact is measured by its angular displacement with respect to a center point of the click wheel). The click wheel may also be used to select one or more of the displayed icons. For example, the user may press down on at least a portion of the click wheel or an associated button. User commands and navigation commands provided by the user via the click wheel may be processed by an input controller **160** as well as one or more of the modules and/or sets of instructions in memory **102**. For a virtual click wheel, the click wheel and click wheel controller may be part of the touch screen **112** and the display controller **156**, respectively. For a virtual click wheel, the click wheel may be either an opaque or semitransparent object that appears and disappears on the touch screen display in response to user interaction with the device. In some embodiments, a virtual click wheel is displayed on the touch screen of a portable multifunction device and operated by user contact with the touch screen.

The device **100** also includes a power system **162** for powering the various components. The power system **162** may include a power management system, one or more power sources (e.g., battery, alternating current (AC)), a recharging system, a power failure detection circuit, a power converter or inverter, a power status indicator (e.g., a light-emitting diode (LED)) and any other components associated with the generation, management and distribution of power in portable devices.

The device **100** may also include one or more optical sensors **164**. FIGS. 1A and 1B show an optical sensor coupled to an optical sensor controller **158** in I/O subsystem **106**. The optical sensor **164** may include charge-coupled device (CCD) or complementary metal-oxide semiconductor (CMOS) phototransistors. The optical sensor **164** receives light from the environment, projected through one or more lens, and converts the light to data representing an image. In conjunction with an imaging module **143** (also called a camera module), the optical sensor **164** may capture still images or video. In some embodiments, an optical sensor is located on the back of the device **100**, opposite the touch screen display **112** on the front of the device, so that the touch screen display may be used as a viewfinder for either still and/or video image acquisition. In some embodiments, an optical sensor is located on the front of the device so that the user's image may be obtained for videoconferencing while the user views the other video conference participants on the touch screen display. In

14

some embodiments, the position of the optical sensor **164** can be changed by the user (e.g., by rotating the lens and the sensor in the device housing) so that a single optical sensor **164** may be used along with the touch screen display for both video conferencing and still and/or video image acquisition.

The device **100** may also include one or more proximity sensors **166**. FIGS. 1A and 1B show a proximity sensor **166** coupled to the peripherals interface **118**. Alternately, the proximity sensor **166** may be coupled to an input controller **160** in the I/O subsystem **106**. The proximity sensor **166** may perform as described in U.S. patent application Ser. Nos. 11/241,839, "Proximity Detector In Handheld Device"; 11/240,788, "Proximity Detector In Handheld Device"; 11/620,702, "Using Ambient Light Sensor To Augment Proximity Sensor Output"; 11/586,862, "Automated Response To And Sensing Of User Activity In Portable Devices"; and 11/638,251, "Methods And Systems For Automatic Configuration Of Peripherals," which are hereby incorporated by reference in their entirety. In some embodiments, the proximity sensor turns off and disables the touch screen **112** when the multifunction device is placed near the user's ear (e.g., when the user is making a phone call). In some embodiments, the proximity sensor keeps the screen off when the device is in the user's pocket, purse, or other dark area to prevent unnecessary battery drainage when the device is a locked state.

The device **100** may also include one or more accelerometers **168**. FIGS. 1A and 1B show an accelerometer **168** coupled to the peripherals interface **118**. Alternately, the accelerometer **168** may be coupled to an input controller **160** in the I/O subsystem **106**. The accelerometer **168** may perform as described in U.S. Patent Publication No. 20050190059, "Acceleration-based Theft Detection System for Portable Electronic Devices," and U.S. Patent Publication No. 20060017692, "Methods And Apparatuses For Operating A Portable Device Based On An Accelerometer," both of which are which are incorporated by reference herein in their entirety. In some embodiments, information is displayed on the touch screen display in a portrait view or a landscape view based on an analysis of data received from the one or more accelerometers.

In some embodiments, the software components stored in memory **102** may include an operating system **126**, a communication module (or set of instructions) **128**, a contact/motion module (or set of instructions) **130**, a graphics module (or set of instructions) **132**, a text input module (or set of instructions) **134**, a Global Positioning System (GPS) module (or set of instructions) **135**, and applications (or set of instructions) **136**.

The operating system **126** (e.g., Darwin, RTXC, LINUX, UNIX, OS X, WINDOWS, or an embedded operating system such as VxWorks) includes various software components and/or drivers for controlling and managing general system tasks (e.g., memory management, storage device control, power management, etc.) and facilitates communication between various hardware and software components.

The communication module **128** facilitates communication with other devices over one or more external ports **124** and also includes various software components for handling data received by the RF circuitry **108** and/or the external port **124**. The external port **124** (e.g., Universal Serial Bus (USB), FIREWIRE, etc.) is adapted for coupling directly to other devices or indirectly over a network (e.g., the Internet, wireless LAN, etc.). In some embodiments, the external port is a multi-pin (e.g., 30-pin) connector that is the same as, or similar to and/or compatible with the 30-pin connector used on iPod (trademark of Apple Computer, Inc.) devices.

US 7,479,949 B2

15

The contact/motion module **130** may detect contact with the touch screen **112** (in conjunction with the display controller **156**) and other touch sensitive devices (e.g., a touchpad or physical click wheel). The contact/motion module **130** includes various software components for performing various operations related to detection of contact, such as determining if contact has occurred, determining if there is movement of the contact and tracking the movement across the touch screen **112**, and determining if the contact has been broken (i.e., if the contact has ceased). Determining movement of the point of contact may include determining speed (magnitude), velocity (magnitude and direction), and/or an acceleration (a change in magnitude and/or direction) of the point of contact. These operations may be applied to single contacts (e.g., one finger contacts) or to multiple simultaneous contacts (e.g., “multitouch”/multiple finger contacts). In some embodiments, the contact/motion module **130** and the display controller **156** also detects contact on a touchpad. In some embodiments, the contact/motion module **130** and the controller **160** detects contact on a click wheel.

The graphics module **132** includes various known software components for rendering and displaying graphics on the touch screen **112**, including components for changing the intensity of graphics that are displayed. As used herein, the term “graphics” includes any object that can be displayed to a user, including without limitation text, web pages, icons (such as user-interface objects including soft keys), digital images, videos, animations and the like.

The text input module **134**, which may be a component of graphics module **132**, provides soft keyboards for entering text in various applications (e.g., contacts **137**, e-mail **140**, IM **141**, blogging **142**, browser **147**, and any other application that needs text input).

The GPS module **135** determines the location of the device and provides this information for use in various applications (e.g., to telephone **138** for use in location-based dialing, to camera **143** and/or blogger **142** as picture/video metadata, and to applications that provide location-based services such as weather widgets, local yellow page widgets, and map/navigation widgets).

The applications **136** may include the following modules (or sets of instructions), or a subset or superset thereof:

- a contacts module **137** (sometimes called an address book or contact list);
- a telephone module **138**;
- a video conferencing module **139**;
- an e-mail client module **140**;
- an instant messaging (IM) module **141**;
- a blogging module **142**;
- a camera module **143** for still and/or video images;
- an image management module **144**;
- a video player module **145**;
- a music player module **146**;
- a browser module **147**;
- a calendar module **148**;
- widget modules **149**, which may include weather widget **149-1**, stocks widget **149-2**, calculator widget **149-3**, alarm clock widget **149-4**, dictionary widget **149-5**, and other widgets obtained by the user, as well as user-created widgets **149-6**;
- widget creator module **150** for making user-created widgets **149-6**;
- search module **151**;
- video and music player module **152**, which merges video player module **145** and music player module **146**;
- notes module **153**; and/or map module **154**; and/or online video module **155**.

16

Examples of other applications **136** that may be stored in memory **102** include other word processing applications, JAVA-enabled applications, encryption, digital rights management, voice recognition, and voice replication.

In conjunction with touch screen **112**, display controller **156**, contact module **130**, graphics module **132**, and text input module **134**, the contacts module **137** may be used to manage an address book or contact list, including: adding name(s) to the address book; deleting name(s) from the address book; associating telephone number(s), e-mail address(es), physical address(es) or other information with a name; associating an image with a name; categorizing and sorting names; providing telephone numbers or e-mail addresses to initiate and/or facilitate communications by telephone **138**, video conference **139**, e-mail **140**, or IM **141**; and so forth. Embodiments of user interfaces and associated processes using contacts module **137** are described further below.

In conjunction with RF circuitry **108**, audio circuitry **110**, speaker **111**, microphone **113**, touch screen **112**, display controller **156**, contact module **130**, graphics module **132**, and text input module **134**, the telephone module **138** may be used to enter a sequence of characters corresponding to a telephone number, access one or more telephone numbers in the address book **137**, modify a telephone number that has been entered, dial a respective telephone number, conduct a conversation and disconnect or hang up when the conversation is completed. As noted above, the wireless communication may use any of a plurality of communications standards, protocols and technologies. Embodiments of user interfaces and associated processes using telephone module **138** are described further below.

In conjunction with RF circuitry **108**, audio circuitry **110**, speaker **111**, microphone **113**, touch screen **112**, display controller **156**, optical sensor **164**, optical sensor controller **158**, contact module **130**, graphics module **132**, text input module **134**, contact list **137**, and telephone module **138**, the video-conferencing module **139** may be used to initiate, conduct, and terminate a video conference between a user and one or more other participants. Embodiments of user interfaces and associated processes using videoconferencing module **139** are described further below.

In conjunction with RF circuitry **108**, touch screen **112**, display controller **156**, contact module **130**, graphics module **132**, and text input module **134**, the e-mail client module **140** may be used to create, send, receive, and manage e-mail. In conjunction with image management module **144**, the e-mail module **140** makes it very easy to create and send e-mails with still or video images taken with camera module **143**. Embodiments of user interfaces and associated processes using e-mail module **140** are described further below.

In conjunction with RF circuitry **108**, touch screen **112**, display controller **156**, contact module **130**, graphics module **132**, and text input module **134**, the instant messaging module **141** may be used to enter a sequence of characters corresponding to an instant message, to modify previously entered characters, to transmit a respective instant message (for example, using a Short Message Service (SMS) or Multimedia Message Service (MMS) protocol for telephony-based instant messages or using XMPP, SIMPLE, or IMPS for Internet-based instant messages), to receive instant messages and to view received instant messages. In some embodiments, transmitted and/or received instant messages may include graphics, photos, audio files, video files and/or other attachments as are supported in a MMS and/or an Enhanced Messaging Service (EMS). As used herein, “instant messaging” refers to both telephony-based messages (e.g., messages sent using SMS or MMS) and Internet-based messages (e.g., mes-

US 7,479,949 B2

17

sages sent using XMPP, SIMPLE, or IMPS). Embodiments of user interfaces and associated processes using instant messaging module **141** are described further below.

In conjunction with RF circuitry **108**, touch screen **112**, display controller **156**, contact module **130**, graphics module **132**, text input module **134**, image management module **144**, and browsing module **147**, the blogging module **142** may be used to send text, still images, video, and/or other graphics to a blog (e.g., the user's blog). Embodiments of user interfaces and associated processes using blogging module **142** are described further below.

In conjunction with touch screen **112**, display controller **156**, optical sensor(s) **164**, optical sensor controller **158**, contact module **130**, graphics module **132**, and image management module **144**, the camera module **143** may be used to capture still images or video (including a video stream) and store them into memory **102**, modify characteristics of a still image or video, or delete a still image or video from memory **102**. Embodiments of user interfaces and associated processes using camera module **143** are described further below.

In conjunction with touch screen **112**, display controller **156**, contact module **130**, graphics module **132**, text input module **134**, and camera module **143**, the image management module **144** may be used to arrange, modify or otherwise manipulate, label, delete, present (e.g., in a digital slide show or album), and store still and/or video images. Embodiments of user interfaces and associated processes using image management module **144** are described further below.

In conjunction with touch screen **112**, display controller **156**, contact module **130**, graphics module **132**, audio circuitry **110**, and speaker **111**, the video player module **145** may be used to display, present or otherwise play back videos (e.g., on the touch screen or on an external, connected display via external port **124**). Embodiments of user interfaces and associated processes using video player module **145** are described further below.

In conjunction with touch screen **112**, display system controller **156**, contact module **130**, graphics module **132**, audio circuitry **110**, speaker **111**, RF circuitry **108**, and browser module **147**, the music player module **146** allows the user to download and play back recorded music and other sound files stored in one or more file formats, such as MP3 or AAC files. In some embodiments, the device **100** may include the functionality of an MP3 player, such as an iPod (trademark of Apple Computer, Inc.). Embodiments of user interfaces and associated processes using music player module **146** are described further below.

In conjunction with RF circuitry **108**, touch screen **112**, display system controller **156**, contact module **130**, graphics module **132**, and text input module **134**, the browser module **147** may be used to browse the Internet, including searching, linking to, receiving, and displaying web pages or portions thereof, as well as attachments and other files linked to web pages. Embodiments of user interfaces and associated processes using browser module **147** are described further below.

In conjunction with RF circuitry **108**, touch screen **112**, display system controller **156**, contact module **130**, graphics module **132**, text input module **134**, e-mail module **140**, and browser module **147**, the calendar module **148** may be used to create, display, modify, and store calendars and data associated with calendars (e.g., calendar entries, to do lists, etc.). Embodiments of user interfaces and associated processes using calendar module **148** are described further below.

In conjunction with RF circuitry **108**, touch screen **112**, display system controller **156**, contact module **130**, graphics module **132**, text input module **134**, and browser module **147**, the widget modules **149** are mini-applications that may be

18

downloaded and used by a user (e.g., weather widget **149-1**, stocks widget **149-2**, calculator widget **149-3**, alarm clock widget **149-4**, and dictionary widget **149-5**) or created by the user (e.g., user-created widget **149-6**). In some embodiments, a widget includes an HTML (Hypertext Markup Language) file, a CSS (Cascading Style Sheets) file, and a JavaScript file. In some embodiments, a widget includes an XML (Extensible Markup Language) file and a JavaScript file (e.g., Yahoo! Widgets). Embodiments of user interfaces and associated processes using widget modules **149** are described further below.

In conjunction with RF circuitry **108**, touch screen **112**, display system controller **156**, contact module **130**, graphics module **132**, text input module **134**, and browser module **147**, the widget creator module **150** may be used by a user to create widgets (e.g., turning a user-specified portion of a web page into a widget). Embodiments of user interfaces and associated processes using widget creator module **150** are described further below.

In conjunction with touch screen **112**, display system controller **156**, contact module **130**, graphics module **132**, and text input module **134**, the search module **151** may be used to search for text, music, sound, image, video, and/or other files in memory **102** that match one or more search criteria (e.g., one or more user-specified search terms). Embodiments of user interfaces and associated processes using search module **151** are described further below.

In conjunction with touch screen **112**, display controller **156**, contact module **130**, graphics module **132**, and text input module **134**, the notes module **153** may be used to create and manage notes, to do lists, and the like. Embodiments of user interfaces and associated processes using notes module **153** are described further below.

In conjunction with RF circuitry **108**, touch screen **112**, display system controller **156**, contact module **130**, graphics module **132**, text input module **134**, GPS module **135**, and browser module **147**, the map module **154** may be used to receive, display, modify, and store maps and data associated with maps (e.g., driving directions; data on stores and other points of interest at or near a particular location; and other location-based data). Embodiments of user interfaces and associated processes using map module **154** are described further below.

In conjunction with touch screen **112**, display system controller **156**, contact module **130**, graphics module **132**, audio circuitry **110**, speaker **111**, RF circuitry **108**, text input module **134**, e-mail client module **140**, and browser module **147**, the online video module **155** allows the user to access, browse, receive (e.g., by streaming and/or download), play back (e.g., on the touch screen or on an external, connected display via external port **124**), send an e-mail with a link to a particular online video, and otherwise manage online videos in one or more file formats, such as H.264. In some embodiments, instant messaging module **141**, rather than e-mail client module **140**, is used to send a link to a particular online video. Additional description of the online video application can be found in U.S. Provisional Patent Application No. 60/936,562, "Portable Multifunction Device, Method, and Graphical User Interface for Playing Online Videos," filed Jun. 20, 2007, and U.S. patent application Ser. No. 11/968,067, "Portable Multifunction Device, Method, and Graphical User Interface for Playing Online Videos," filed Dec. 31, 2007, the content of which is hereby incorporated by reference in its entirety.

Each of the above identified modules and applications correspond to a set of instructions for performing one or more functions described above. These modules (i.e., sets of

US 7,479,949 B2

19

instructions) need not be implemented as separate software programs, procedures or modules, and thus various subsets of these modules may be combined or otherwise re-arranged in various embodiments. For example, video player module **145** may be combined with music player module **146** into a single module (e.g., video and music player module **152**, FIG. 1B). In some embodiments, memory **102** may store a subset of the modules and data structures identified above. Furthermore, memory **102** may store additional modules and data structures not described above.

In some embodiments, the device **100** is a device where operation of a predefined set of functions on the device is performed exclusively through a touch screen **112** and/or a touchpad. By using a touch screen and/or a touchpad as the primary input/control device for operation of the device **100**, the number of physical input/control devices (such as push buttons, dials, and the like) on the device **100** may be reduced.

The predefined set of functions that may be performed exclusively through a touch screen and/or a touchpad include navigation between user interfaces. In some embodiments, the touchpad, when touched by the user, navigates the device **100** to a main, home, or root menu from any user interface that may be displayed on the device **100**. In such embodiments, the touchpad may be referred to as a "menu button." In some other embodiments, the menu button may be a physical push button or other physical input/control device instead of a touchpad.

FIG. 2 illustrates a portable multifunction device **100** having a touch screen **112** in accordance with some embodiments. The touch screen may display one or more graphics within user interface (UI) **200**. In this embodiment, as well as others described below, a user may select one or more of the graphics by making contact or touching the graphics, for example, with one or more fingers **202** (not drawn to scale in the figure). In some embodiments, selection of one or more graphics occurs when the user breaks contact with the one or more graphics. In some embodiments, the contact may include a gesture, such as one or more taps, one or more swipes (from left to right, right to left, upward and/or downward) and/or a rolling of a finger (from right to left, left to right, upward and/or downward) that has made contact with the device **100**. In some embodiments, inadvertent contact with a graphic may not select the graphic. For example, a swipe gesture that sweeps over an application icon may not select the corresponding application when the gesture corresponding to selection is a tap.

The device **100** may also include one or more physical buttons, such as "home" or menu button **204**. As described previously, the menu button **204** may be used to navigate to any application **136** in a set of applications that may be executed on the device **100**. Alternatively, in some embodiments, the menu button is implemented as a soft key in a GUI in touch screen **112**.

In one embodiment, the device **100** includes a touch screen **112**, a menu button **204**, a push button **206** for powering the device on/off and locking the device, volume adjustment button(s) **208**, a Subscriber Identity Module (SIM) card slot **210**, a head set jack **212**, and a docking/charging external port **124**. The push button **206** may be used to turn the power on/off on the device by depressing the button and holding the button in the depressed state for a predefined time interval; to lock the device by depressing the button and releasing the button before the predefined time interval has elapsed; and/or to unlock the device or initiate an unlock process. In an alternative embodiment, the device **100** also may accept verbal input for activation or deactivation of some functions through the microphone **113**.

20

Attention is now directed towards embodiments of user interfaces ("UI") and associated processes that may be implemented on a portable multifunction device **100**.

FIGS. 3A-3C illustrate exemplary user interfaces for unlocking a portable electronic device in accordance with some embodiments. In some embodiments, user interface **300A** includes the following elements, or a subset or superset thereof:

Unlock image **302** that is moved with a finger gesture to unlock the device;

Arrow **304** that provides a visual cue to the unlock gesture; Channel **306** that provides additional cues to the unlock gesture;

Time **308**;

Day **310**;

Date **312**; and

Wallpaper image **314**.

In some embodiments, in addition to or in place of wallpaper image **314**, an unlock user interface may include a device charging status icon **316** and a headset charging status icon **318** (e.g., UI **300B**, FIG. 3B). The device charging status icon **316** indicates the battery status while the device **100** is being recharged (e.g., in a dock). Similarly, headset charging status icon **318** indicates the battery status of a headset associated with device **100** (e.g., a Bluetooth headset) while the headset is being recharged (e.g., in another portion of the dock).

In some embodiments, the device detects contact with the touch-sensitive display (e.g., a user's finger making contact on or near the unlock image **302**) while the device is in a user-interface lock state. The device moves the unlock image **302** in accordance with the contact. The device transitions to a user-interface unlock state if the detected contact corresponds to a predefined gesture, such as moving the unlock image across channel **306**. Conversely, the device maintains the user-interface lock state if the detected contact does not correspond to the predefined gesture. This process saves battery power by ensuring that the device is not accidentally awakened. This process is easy for users to perform, in part because of the visual cue(s) provided on the touch screen.

In some embodiments, after detecting an unlock gesture, the device displays a passcode (or password) interface (e.g., UI **300C**, FIG. 3C) for entering a passcode to complete the unlock process. The addition of a passcode protects against unauthorized use of the device. In some embodiments, the passcode interface includes an emergency call icon that permits an emergency call (e.g., to 911) without entering the passcode. In some embodiments, the use of a passcode is a user-selectable option (e.g., part of settings **412**).

As noted above, processes that use gestures on the touch screen to unlock the device are described in U.S. patent application Ser. Nos. 11/322,549, "Unlocking A Device By Performing Gestures On An Unlock Image," filed Dec. 23, 2005, and 11/322,550, "Indication Of Progress Towards Satisfaction Of A User Input Condition," filed Dec. 23, 2005, which are hereby incorporated by reference in their entirety.

FIGS. 4A and 4B illustrate exemplary user interfaces for a menu of applications on a portable multifunction device in accordance with some embodiments. In some embodiments, user interface **400A** includes the following elements, or a subset or superset thereof:

Signal strength indicator(s) **402** for wireless communication(s), such as cellular and Wi-Fi signals;

Time **404**;

Bluetooth indicator **405**;

Battery status indicator **406**;

US 7,479,949 B2

21

Tray **408** with icons for frequently used applications, such as:

Phone **138**, which may include an indicator **414** of the number of missed calls or voicemail messages;

E-mail client **140**, which may include an indicator **410** of the number of unread e-mails;

Browser **147**; and

Music player **146**; and

Icons for other applications, such as:

IM **141**;

Image management **144**;

Camera **143**;

Video player **145**;

Weather **149-1**;

Stocks **149-2**;

Blog **142**;

Calendar **148**;

Calculator **149-3**;

Alarm clock **149-4**;

Dictionary **149-5**; and

User-created widget **149-6**.

In some embodiments, user interface **400B** includes the following elements, or a subset or superset thereof:

402, **404**, **405**, **406**, **141**, **148**, **144**, **143**, **149-3**, **149-2**, **149-1**, **149-4**, **410**, **414**, **138**, **140**, and **147**, as described above;

Map **154**;

Notes **153**;

Settings **412**, which provides access to settings for the device **100** and its various applications **136**, as described further below;

Video and music player module **152**, also referred to as iPod (trademark of Apple Computer, Inc.) module **152**; and

Online video module **155**, also referred to as YouTube (trademark of Google, Inc.) module **155**.

In some embodiments, UI **400A** or **400B** displays all of the available applications **136** on one screen so that there is no need to scroll through a list of applications (e.g., via a scroll bar). In some embodiments, as the number of applications increase, the icons corresponding to the applications may decrease in size so that all applications may be displayed on a single screen without scrolling. In some embodiments, having all applications on one screen and a menu button enables a user to access any desired application with at most two inputs, such as activating the menu button **204** and then activating the desired application (e.g., by a tap or other finger gesture on the icon corresponding to the application). In some embodiments, a predefined gesture on the menu button **204** (e.g., a double tap or a double click) acts as a short cut that initiates display of a particular user interface in a particular application. In some embodiments, the short cut is a user-selectable option (e.g., part of settings **412**). For example, if the user makes frequent calls to persons listed in a Favorites UI (e.g., UI **2700A**, FIG. **27A**) in the phone **138**, the user may choose to have the Favorites UI be displayed in response to a double click on the menu button. As another example, the user may choose to have a UI with information about the currently playing music (e.g., UI **4300S**, FIG. **43S**) be displayed in response to a double click on the menu button.

In some embodiments, UI **400A** or **400B** provides integrated access to both widget-based applications and non-widget-based applications. In some embodiments, all of the widgets, whether user-created or not, are displayed in UI **400A** or **400B**. In other embodiments, activating the icon for

22

user-created widget **149-6** may lead to another UI that contains the user-created widgets or icons corresponding to the user-created widgets.

In some embodiments, a user may rearrange the icons in UI **400A** or **400B**, e.g., using processes described in U.S. patent application Ser. No. 11/459,602, "Portable Electronic Device With Interface Reconfiguration Mode," filed Jul. 24, 2006, which is hereby incorporated by reference in its entirety. For example, a user may move application icons in and out of tray **408** using finger gestures.

In some embodiments, UI **400A** or **400B** includes a gauge (not shown) that displays an updated account usage metric for an account associated with usage of the device (e.g., a cellular phone account), as described in U.S. patent application Ser. No. 11/322,552, "Account Information Display For Portable Communication Device," filed Dec. 23, 2005, which is hereby incorporated by reference in its entirety.

In some embodiments, a signal strength indicator **402** (FIG. **4B**) for a WiFi network is replaced by a symbol for a cellular network (e.g., the letter "E" for an EDGE network, FIG. **4A**) when the device switches from using the WiFi network to using the cellular network for data transmission (e.g., because the WiFi signal is weak or unavailable).

Instant Messaging

FIG. **5** illustrates an exemplary user interface for listing instant message conversations on a portable multifunction device in accordance with some embodiments. In some embodiments, user interface **500** includes the following elements, or a subset or superset thereof:

402, **404**, and **406**, as described above;

"Instant Messages" or other similar label **502**;

Names **504** of the people a user is having instant message conversations with (e.g., Jane Doe **504-1**) or the phone number if the person's name is not available (e.g., 408-123-4567 **504-3**);

Text **506** of the last message in the conversation;

Date **508** and/or time of the last message in the conversation;

Selection icon **510** that when activated (e.g., by a finger tap on the icon) initiates transition to a UI for the corresponding conversation (e.g., FIG. **6A** for Jane Doe **504-1**);

Edit icon **512** that when activated (e.g., by a finger tap on the icon) initiates transition to a UI for deleting conversations (e.g., FIG. **7**);

Create message icon **514** that when activated (e.g., by a finger tap on the icon) initiates transition to the users contact list (e.g., FIG. **8A**); and

Vertical bar **516** that helps a user understand what portion of the list of instant message conversations is being displayed.

In some embodiments, the name **504** used for an instant message conversation is determined by finding an entry in the user's contact list **137** that contains the phone number used for the instant message conversation. If no such entry is found, then just the phone number is displayed (e.g., **504-3**). In some embodiments, if the other party sends messages from two or more different phone numbers, the messages may appear as a single conversation under a single name if all of the phone numbers used are found in the same entry (i.e., the entry for the other party) in the user's contact list **137**.

Automatically grouping the instant messages into "conversations" (instant message exchanges with the same user or the same phone number) makes it easier for the user to carry on and keep track of instant message exchanges with multiple parties.

In some embodiments, vertical bar **516** is displayed temporarily after an object is detected on or near the touch screen display (e.g., a finger touch is detected anywhere on the list of instant message conversations). In some embodiments, the vertical bar **516** has a vertical position on top of the displayed portion of the list that corresponds to the vertical position in the list of the displayed portion of the list. In some embodiments, the vertical bar **516** has a vertical length that corresponds to the portion of the list being displayed. In some embodiments, if the entire list of IM conversations can be displayed simultaneously on the touch screen **112**, the vertical bar **516** is not displayed. In some embodiments, if the entire list of IM conversations can be displayed simultaneously on the touch screen **112**, the vertical bar **516** is displayed with a length that corresponds to the length of the list display area (e.g., as shown in FIG. 5).

FIGS. 6A-6K illustrate an exemplary user interface for inputting text for an instant message in accordance with some embodiments.

In some embodiments, user interface **600A** includes the following elements, or a subset or superset thereof:

402, 404, and 406, as described above;

Name **504** corresponding to the phone number used in the instant message conversation (or the phone number itself if the name is not available);

Instant messages icon **602** that when activated (e.g., by a finger tap on the icon) initiates transition to a UI listing instant message conversations (e.g., UI **500**);

Instant messages **604** from the other party, typically listed in order along one side of UI **600A**;

Instant messages **606** to the other party, typically listed in order along the opposite side of UI **600A** to show the back and forth interplay of messages in the conversation; Timestamps **608** for at least some of the instant messages; Text entry box **612**;

Send icon **614** that when activated (e.g., by a finger tap on the icon) initiates sending of the message in text box **612** to the other party (e.g., Jane Doe **504-1**);

Letter keyboard **616** for entering text in box **612**;

Alternate keyboard selector icon **618** that when activated (e.g., by a finger tap on the icon) initiates the display of a different keyboard (e.g., **624**, FIG. 6C);

Return icon **620** that when activated (e.g., by a finger tap on the icon) initiates sending of the message in text box **612** to the other party (e.g., Jane Doe **504-1**);

Shift key **628** that when activated (e.g., by a finger tap on the icon) capitalizes the next letter chosen on letter keyboard **616**; and

Vertical bar **630** that helps a user understand what portion of the list of instant messages in an IM conversation is being displayed.

In some embodiments, a user can scroll through the message conversation (comprised of messages **604** and **606**) by applying a vertical swipe gesture **610** to the area displaying the conversation. In some embodiments, a vertically downward gesture scrolls the conversation downward, thereby showing older messages in the conversation. In some embodiments, a vertically upward gesture scrolls the conversation upward, thereby showing newer, more recent messages in the conversation. In some embodiments, as noted above, the last message in the conversation (e.g., **606-2**) is displayed in the list of instant messages **500** (e.g., **506-1**).

In some embodiments, keys in keyboards **616** (FIGS. 6A, 6B, 6E-6K), **624** (FIG. 6C), and/or **639** (FIG. 6D) briefly change shade and/or color when touched/activated by a user to help the user learn to activate the desired keys.

In some embodiments, vertical bar **630** is displayed temporarily after an object is detected on or near the touch screen display (e.g., a finger touch is detected anywhere on the list of instant messages). In some embodiments, the vertical bar **630** has a vertical position on top of the displayed portion of the list that corresponds to the vertical position in the list of the displayed portion of the list. In some embodiments, the vertical bar **630** has a vertical length that corresponds to the portion of the list being displayed. For example, in FIG. 6A, the vertical position of the vertical bar **630** indicates that the bottom of the list of messages is being displayed (which correspond to the most recent messages) and the vertical length of the vertical bar **630** indicates that roughly half of the messages in the conversation are being displayed.

In some embodiments, user interface **600B** includes the following elements, or a subset or superset thereof:

402, 404, 406, 504, 602, 604, 606, 608, 612, 614, 616, 618, 620, and 630 as described above; and

word suggestion area **622** that provides a list of possible words to complete the word fragment being typed by the user in box **612**.

In some embodiments, the word suggestion area does not appear in UI **600B** until after a predefined time delay (e.g., 2-3 seconds) in text being entered by the user. In some embodiments, the word suggestion area is not used or can be turned off by the user.

In some embodiments, user interface **600C** includes the following elements, or a subset or superset thereof:

402, 404, 406, 504, 602, 604, 606, 608, 612, 614, 620, and 622 as described above;

Alternate keyboard **624**, which may be made up primarily of digits and punctuation, with frequently used punctuation keys (e.g., period key **631**, comma key **633**, question mark key **635**, and exclamation point key **637**) made larger than the other keys;

Letter keyboard selector icon **626** that when activated (e.g., by a finger tap on the icon) initiates the display of a letter keyboard (e.g., **616**, FIG. 6A); and

Shift key **628** that when activated (e.g., by a finger tap on the icon) initiates display of yet another keyboard (e.g., **639**, FIG. 6D).

In some embodiments, keeping the period key **631** near keyboard selector icon **626** reduces the distance that a user's finger needs to travel to enter the oft-used period.

In some embodiments, user interface **600D** includes the following elements, or a subset or superset thereof:

402, 404, 406, 504, 602, 604, 606, 608, 612, 614, 620, 622, 626, 628 as described above; and

Another alternate keyboard **639**, which may be made up primarily of symbols and punctuation, with frequently used punctuation keys (e.g., period key **631**, comma key **633**, question mark key **635**, and exclamation point key **637**) made larger than the other keys.

In some embodiments, user interface **600E** includes the following elements, or a subset or superset thereof:

402, 404, 406, 504, 602, 604, 606, 608, 612, 614, 616, 618, and 620, as described above; and

New instant message **606-3** sent to the other party.

In some embodiments, when the user activates a send key (e.g., either **614** or **620**), the text in text box **612** "pops" or otherwise comes out of the box and becomes part of the string of user messages **606** to the other party. The black arrows in FIG. 6E illustrate an animated formation of a quote bubble **606-3**. In some embodiments, the size of the quote bubble scales with the size of the message. In some embodiments, a sound is also made when the message is sent, such as a droplet sound, to notify the user.

US 7,479,949 B2

25

In some embodiments, user interface **600F** includes the following elements, or a subset or superset thereof:

402, 404, 406, 612, 614, 616, 618, 620, and 628, as described above;

Recipient input field **632** that when activated (e.g., by a finger tap on the field) receives and displays the phone number of the recipient of the instant message (or the recipient's name if the recipient is already in the user's contact list);

Add recipient icon **634** that when activated (e.g., by a finger tap on the icon) initiates the display of a scrollable list of contacts (e.g., **638**, FIG. 6G); and

Cancel icon **636** that when activated (e.g., by a finger tap on the icon) cancels the new instant message.

In some embodiments, user interface **600G** includes the following elements, or a subset or superset thereof:

402, 404, 406, 616, 618, 620, 628, 632, 634, and 636, as described above;

Scrollable list **638** of contacts that match the input in recipient input field **632**; and

Vertical bar **640** that helps a user understand how many items in the contact list that match the input in recipient input field **632** are being displayed.

In some embodiments, list **638** contains contacts that match the input in recipient input field **632**. For example, if the letter "v" is input, then contacts with either a first name or last name beginning with "v" are shown. If the letters "va" are input in field **632**, then the list of contacts is narrowed to contacts with either a first name or last name beginning with "va", and so on until one of the displayed contacts is selected (e.g., by a tap on a contact in the list **638**).

In some embodiments, a user can scroll through the list **638** by applying a vertical swipe gesture **642** to the area displaying the list **638**. In some embodiments, a vertically downward gesture scrolls the list downward and a vertically upward gesture scrolls the list upward,

In some embodiments, vertical bar **640** is displayed temporarily after an object is detected on or near the touch screen display (e.g., a finger touch is detected anywhere on the list **638**). In some embodiments, the vertical bar **640** has a vertical position on top of the displayed portion of the list that corresponds to the vertical position in the list of the displayed portion of the list. In some embodiments, the vertical bar **640** has a vertical length that corresponds to the portion of the list being displayed.

In some embodiments, user interfaces **600H** and **600I** include the following elements, or a subset or superset thereof:

402, 404, 406, 612, 614, 616, 618, 620, 628, 632, 634, and 636, as described above;

Suggested word **644** adjacent to the word being input;

Suggested word **646** in the space bar in keyboard **616**; and/or

Insertion marker **656** (e.g., a cursor, insertion bar, insertion point, or pointer).

In some embodiments, activating suggested word **644** (e.g., by a finger tap on the suggested word) replaces the word being typed with the suggested word **644**. In some embodiments, activating suggested word **646** (e.g., by a finger tap on the space bar) replaces the word being typed with the suggested word **646**. In some embodiments, a user can set whether suggested words **644** and/or **646** are shown (e.g., by setting a user preference).

In some embodiments, a letter is enlarged briefly after it is selected (e.g., "N" is enlarged briefly after typing "din" in FIG. 6H) to provide feedback to the user.

26

In some embodiments, user interfaces **600J** and **600K** include the following elements, or a subset or superset thereof:

402, 404, 406, 612, 614, 616, 618, 620, 628, 632, 634, 636, 646, and 656 as described above; and

Expanded portion **650** of graphics that helps a user adjust the position of an expanded insertion marker **657** (sometimes called an "insertion point magnifier"); and
Expanded insertion marker **657**.

In some embodiments, a finger contact **648-1** on or near the insertion marker **656** initiates display of insertion point magnifier **650** and expanded insertion marker **657-1**. In some embodiments, as the finger contact is moved on the touch screen (e.g., to position **648-2**), there is corresponding motion of the expanded insertion marker (e.g., to **657-2**) and the insertion point magnifier **650**. Thus, the insertion point magnifier **650** provides an efficient way to position a cursor or other insertion marker using finger input on the touch screen. In some embodiments, the magnifier **650** remains visible and can be repositioned as long as continuous contact is maintained with the touch screen (e.g., from **648-1** to **648-2** to even **648-3**).

In some embodiments, a portable electronic device displays graphics and an insertion marker (e.g., marker **656**, FIG. 6I) at a first location in the graphics on a touch screen display (e.g., FIG. 6I). In some embodiments, the insertion marker **656** is a cursor, insertion bar, insertion point, or pointer. In some embodiments, the graphics comprise text (e.g., text in box **612**, FIG. 6I).

A finger contact is detected with the touch screen display (e.g., contact **648-1**, FIG. 6I). In some embodiments, the location of the finger contact is proximate to the location of the insertion marker. In some embodiments, the location of the finger contact is anywhere within a text entry area (e.g., box **612**, FIG. 6I).

In response to the detected finger contact, the insertion marker is expanded from a first size (e.g., marker **656**, FIG. 6I) to a second size (e.g., marker **657-1**, FIG. 6J) on the touch screen display, and a portion (e.g., portion **650-1**, FIG. 6J) of the graphics on the touch screen display is expanded from an original size to an expanded size.

In some embodiments, the portion of the graphics that is expanded includes the insertion marker and adjacent graphics. In some embodiments, after the insertion point and the portion of the graphics are expanded, graphics are displayed that include the insertion marker and adjacent graphics at the original size and at the expanded size.

Movement of the finger contact is detected on the touch screen display (e.g., from **648-1** to **648-2**, FIG. 6J).

The expanded insertion marker is moved in accordance with the detected movement of the finger contact from the first location (e.g., **657-1**, FIG. 6J) to a second location in the graphics (e.g., **657-2**, FIG. 6J).

In some embodiments, the portion of the graphics that is expanded changes as the insertion marker moves from the first location to the second location (e.g., from **650-1** to **650-2**, FIG. 6J). In some embodiments, the portion of the graphics that is expanded is displayed in a predefined shape. In some embodiments the portion (e.g., **650**, FIG. 6J) of the graphics that is expanded is displayed in a circle. In some embodiments, the expanded insertion marker **657** is within the circle.

In some embodiments, the detected movement of the finger contact has a horizontal component on the touch screen display and a vertical component on the touch screen display. In some embodiments, moving the expanded insertion marker **657** in accordance with the detected movement of the finger contact includes moving the expanded insertion marker and

the expanded portion of the graphics in accordance with the horizontal component of motion of the finger contact if the finger contact moves outside a text entry area without breaking contact. For example, in FIG. 6J, if the finger contact moves from **648-2** (inside the text entry area **612**) to **648-3** (in the keyboard area), the expanded insertion point **657** and the expanded portion **650** of the graphics may move horizontally along the lower portion of the text entry area in accordance with the horizontal component of the movement from **648-2** to **648-3** (not shown).

In some embodiments, moving the expanded insertion marker in accordance with the detected movement of the finger contact includes moving the expanded insertion marker in a first area of the touch screen that includes characters entered using a soft keyboard (e.g., text box **612**, FIG. 6J), wherein the soft keyboard is located in a second area of the touch screen that is separate from the first area (e.g., keyboard **616**, FIG. 6J).

In some embodiments, the expanded insertion marker is contracted from the second size to the first size if finger contact with the touch screen display is broken (e.g., insertion marker **656**, FIG. 6K). In some embodiments, the contracting includes an animation of the expanded insertion marker **657** shrinking into the insertion marker **656** at the second location. As used herein, an animation is a display of a sequence of images that gives the appearance of movement, and informs the user of an action that has been performed (such as moving an insertion point). A respective animation that confirms an action by the user of the device typically takes a predefined, finite amount of time, such as an amount of time between 0.2 and 0.5 seconds, between 0.2 and 1.0 seconds, or between 0.5 and 2.0 seconds, depending on the context.

In some embodiments, the expanded portion **650** of the graphics is contracted if finger contact with the touch screen display is no longer detected for a predetermined time.

A graphical user interface on a portable electronic device with a touch screen display comprises an insertion marker and graphics. In response to detecting a finger contact **648** with the touch screen display, the insertion marker is expanded from a first size **656** to a second size **657**, and a portion **650** of the graphics is expanded. In response to detecting movement of the finger contact on the touch screen display, the expanded insertion marker is moved in accordance with the detected movement of the finger contact from a first location **657-1** in the graphics to a second location **657-2** in the graphics.

Additional description of insertion marker positioning can be found in U.S. patent application Ser. No. 11/553,436, "Method, System, And Graphical User Interface For Positioning An Insertion Marker In A Touch Screen Display," filed Oct. 26, 2006, and U.S. Provisional Patent Application No. 60/947,382, "Portable Multifunction Device, Method, and Graphical User Interface for Adjusting an Insertion Point Marker," filed Jun. 29, 2007, and U.S. patent application Ser. No. 11/923,453, "Portable Multifunction Device, Method, and Graphical User Interface for Adjusting an Insertion Point Marker," filed Oct. 24, 2007, the contents of which are hereby incorporated by reference herein in their entirety.

Additional description of instant messaging on portable electronic devices can be found in U.S. Provisional Patent Application Nos. 60/883,819, "Portable Electronic Device For Instant Messaging," filed Jan. 7, 2007, and 60/946,969, "Portable Electronic Device For Instant Messaging," filed Jun. 28, 2007, and U.S. patent application Ser. No. 11/848,208, "Portable Electronic Device for Instant Messaging," filed Aug. 30, 2007, the contents of which are hereby incorporated by reference in their entirety.

FIG. 7 illustrates an exemplary user interface for deleting an instant message conversation in accordance with some embodiments. In some embodiments, user interface **700** includes the following elements, or a subset or superset thereof:

- 402, 404, 406, 502, 504, 506, 508**, as described above;
- Delete icons **702**;
- Confirm delete icon **704**; and
- Done icon **706**.

In some embodiments, if the user activates edit icon **512** (FIG. 5), the delete icons **702** appear next to each instant message conversation. If a user activates a delete icon (e.g., by tapping it with a finger), the icon may rotate 90 degrees (e.g., **702-4**) or otherwise change its appearance and/or a second icon may appear (e.g., confirm delete icon **704**). If the user activates the second icon, the corresponding instant message conversation is deleted.

This deletion process, which requires multiple gestures by the user on different parts of the touch screen (e.g., delete icon **702-4** and confirm delete icon **704** are on opposite sides of the touch screen) greatly reduces the chance that a user will accidentally delete a conversation or other similar item.

The user activates the done icon **706** (e.g., by tapping on it with a finger) when the user has finished deleting IM conversations and the device returns to UI **500**.

If there is a long list of conversations (not shown) that fill more than the screen area, the user may scroll through the list using vertically upward and/or vertically downward gestures **708** on the touch screen.

Additional description of deletion gestures on portable electronic devices can be found in U.S. Provisional Patent Application Nos. 60/883,814, "Deletion Gestures On A Portable Multifunction Device," filed Jan. 7, 2007 and 60/936,755, "Deletion Gestures On A Portable Multifunction Device," filed Jun. 22, 2007, and U.S. patent application Ser. No. 11/850,642, "Deletion Gestures on a Portable Multifunction Device," filed Sep. 5, 2007, the contents of which are hereby incorporated by reference in their entirety.

FIGS. **8A** and **8B** illustrate an exemplary user interface for a contact list in accordance with some embodiments.

In some embodiments, user interfaces **800A** and **800B** include the following elements, or a subset or superset thereof:

- 402, 404, 406**, as described above;
- Groups icon **802** that when activated (e.g., by a finger tap on the icon) initiates display of groups of contacts;
- First name icon **804** that when activated (e.g., by a finger tap on the icon) initiates an alphabetical display of the user's contacts by their first names (FIG. **8B**);
- Last name icon **806** that when activated (e.g., by a finger tap on the icon) initiates an alphabetical display of the user's contacts by their last names (FIG. **8A**);
- Alphabet list icons **808** that the user can touch to quickly arrive at a particular first letter in the displayed contact list;
- Cancel icon **810** that when activated (e.g., by a finger tap on the icon) initiates transfer back to the previous UI (e.g., UI **500**); and
- Other number icon **812** that when activated (e.g., by a finger tap on the icon) initiates transfer to a UI for entering a phone number for instant messaging, such as a phone number that is not in the user's contact list (e.g., UI **900**, FIG. **9**).

In some embodiments, the functions of first name icon **804** and last name icon **806** are incorporated into settings **412** (FIG. **4B**, e.g., as a user preference setting) rather than being displayed in a contacts list UI (e.g., **800A** and **800B**).

US 7,479,949 B2

29

As described in U.S. patent application Ser. Nos. 11/322, 547, "Scrolling List With Floating Adjacent Index Symbols," filed Dec. 23, 2005; 11/322,551, "Continuous Scrolling List With Acceleration," filed Dec. 23, 2005; and 11/322,553, "List Scrolling In Response To Moving Contact Over List Of Index Symbols," filed Dec. 23, 2005, which are hereby incorporated by reference in their entirety, the user may scroll through the contact list using vertically upward and/or vertically downward gestures **814** on the touch screen.

FIG. 9 illustrates an exemplary user interface for entering a phone number for instant messaging in accordance with some embodiments. In some embodiments, user interface **900** includes the following elements, or a subset or superset thereof:

402, 404, 406, 504, 602, and 624, as described above;

Cancel icon **902** that when activated (e.g., by a finger tap on the icon) initiates transfer back to the previous UI (e.g., UI **800A** or UI **800B**);

Save icon **904** that when activated (e.g., by a finger tap on the icon) initiates saving the entered phone number in the instant messages conversation list (e.g., UI **500**) and displaying a UI to compose an instant message to be sent to the entered phone number (e.g., UI **600A**); and

Number entry box **906** for entering the phone number using keyboard **624**.

Note that the keyboard displayed may depend on the application context. For example, the UI displays a soft keyboard with numbers (e.g., **624**) when numeric input is needed or expected. The UI displays a soft keyboard with letters (e.g., **616**) when letter input is needed or expected.

In some embodiments, instead of using UI **900**, a phone number for instant messaging may be entered in UI **600F** (FIG. 6F) by inputting numbers in To: field **632** using numeric keypad **624**.

Camera

FIG. 10 illustrates an exemplary user interface for a camera in accordance with some embodiments. In some embodiments, user interface **1000** includes the following elements, or a subset or superset thereof:

Viewfinder **1002**;

Camera roll **1004** that manages images and/or videos taken with the camera;

Shutter **1006** for taking still images;

Record button **1008** for starting and stopping video recording;

Timer **1010** for taking an image after a predefined time delay; and

Image **1012** that appears (e.g., via the animation illustrated schematically in FIG. 10) to be added to camera roll **1004** when it is obtained.

In some embodiments, the orientation of the camera in the shutter icon **1006** rotates as the device **100** is rotated between portrait and landscape orientations.

FIG. 11 illustrates an exemplary user interface for a camera roll in accordance with some embodiments. In some embodiments, user interface **1100** includes the following elements, or a subset or superset thereof:

402, 404, and 406, as described above;

Thumbnail images **1102** of images and/or videos obtained by camera **143**;

Camera icon **1104** or done icon **1110** that when activated (e.g., by a finger tap on the icon) initiates transfer to the camera UI (e.g., UI **1000**); and

Vertical bar **1112** that helps a user understand what portion of the camera roll is being displayed.

30

In some embodiments, the user may scroll through the thumbnails **1102** using vertically upward and/or vertically downward gestures **1106** on the touch screen. In some embodiments, a stationary gesture on a particular thumbnail (e.g., a tap gesture **1108** on thumbnail **1102-11**) initiates transfer to an enlarged display of the corresponding image (e.g., UI **1200A**).

In some embodiments, vertical bar **1112** is displayed temporarily after an object is detected on or near the touch screen display (e.g., a finger touch is detected anywhere on the thumbnails **1102**). In some embodiments, the vertical bar **1112** has a vertical position on top of the displayed portion of the camera roll that corresponds to the vertical position in the camera roll of the displayed portion of the camera roll. In some embodiments, the vertical bar **1112** has a vertical length that corresponds to the portion of the camera roll being displayed. For example, in FIG. 11, the vertical position of the vertical bar **1112** indicates that the middle of the camera roll is being displayed and the vertical length of the vertical bar **1112** indicates that roughly half of the images in the camera roll are being displayed.

FIGS. 12A-12C illustrate an exemplary user interface for viewing and manipulating acquired images in accordance with some embodiments.

In some embodiments, user interface **1200A** includes the following elements, or a subset or superset thereof:

402, 404, 406, 1104, and 1110, as described above;

Camera roll icon **1202** that when activated (e.g., by a finger tap on the icon) initiates transfer to the camera roll UI (e.g., UI **1100**);

Image **1204**;

Additional options icon **1206** that when activated (e.g., by a finger tap on the icon) initiates transfer to a UI with additional options for use of image **1204** (e.g., UI **1700**, FIG. 17));

Previous image icon **1208** that when activated (e.g., by a finger tap on the icon) initiates display of the previous image in the camera roll (e.g., **1102-10**);

Play icon **1210** that when activated (e.g., by a finger tap on the icon) initiates a slide show of the images in the camera roll;

Next image icon **1212** that when activated (e.g., by a finger tap on the icon) initiates display of the next image in the camera roll (e.g., **1102-12**);

Delete symbol icon **1214** that when activated (e.g., by a finger tap on the icon) initiates display of a UI to confirm that the user wants to delete image **1204** (e.g. UI **1200B**, FIG. 12B);

Vertical bar **1222** that helps a user understand what portion of the image **1204** is being displayed; and

Horizontal bar **1224** that helps a user understand what portion of the image **1204** is being displayed.

In some embodiments, the user can also initiate viewing of the previous image by making a tap gesture **1216** on the left side of the image. In some embodiments, the user can also initiate viewing of the previous image by making a swipe gesture **1220** from left to right on the image.

In some embodiments, the user can also initiate viewing of the next image by making a tap gesture **1218** on the right side of the image. In some embodiments, the user can also initiate viewing of the next image by making a swipe gesture **1220** from right to left on the image.

By offering multiple ways to perform the same task (e.g., to view the next image by tapping icon **1212**, tap **1218**, or right to left swipe **1220**), the user can choose whichever way the user prefers, thereby making the UI simpler and more intuitive for the user.

US 7,479,949 B2

31

In some embodiments, image **1204** moves off screen to the left as the next image moves on screen from the right. In some embodiments, image **1204** moves off screen to the right as the previous image moves on screen from the left.

In some embodiments, a tap gesture such as **1216** or **1218** magnifies the image **1204** by a predetermined amount, rather than initiating viewing of another image, so that just a portion of image **1204** is displayed. In some embodiments, when the image is already magnified, repeating the tap gesture demagnifies the image (e.g., so that the entire image is displayed).

In some embodiments, if just a portion of image **1204** is displayed, vertical bar **1222** is displayed temporarily after an object is detected on or near the touch screen display (e.g., a finger touch is detected anywhere on the image **1204**). In some embodiments, the vertical bar **1222** has a vertical position on top of the displayed portion of the image that corresponds to the vertical position in the image of the displayed portion of the image. In some embodiments, the vertical bar **1222** has a vertical length that corresponds to the portion of the image being displayed. For example, in FIG. **12A**, the vertical position of the vertical bar **1222** indicates that the top of the image is being displayed and the vertical length of the vertical bar **1222** indicates that a portion from the top half of the image is being displayed.

In some embodiments, if just a portion of image **1204** is displayed, horizontal bar **1224** is displayed temporarily after an object is detected on or near the touch screen display (e.g., a finger touch is detected anywhere on the image **1204**). In some embodiments, the horizontal bar **1224** has a horizontal position on top of the displayed portion of the image that corresponds to the horizontal position in the image of the displayed portion of the image. In some embodiments, the horizontal bar **1224** has a horizontal length that corresponds to the portion of the image being displayed. For example, in FIG. **12A**, the horizontal position of the horizontal bar **1224** indicates that a portion of the right side of the image is being displayed and the horizontal length of the horizontal bar **1224** indicates that a portion from the right half of the image is being displayed. Together, vertical bar **1222** and horizontal bar **1224** indicate that the northeast quadrant of the image **1204** is being displayed.

In some embodiments, user interface **1200B** includes the following elements, or a subset or superset thereof:

402, 404, 406, 1104, 1110, 1202, and 1204, as described above;

Delete icon **1216** that when activated (e.g., by a finger tap on the icon) deletes the image **1204**; and

Cancel icon **1218** that when activated (e.g., by a finger tap on the icon) returns the device to the previous user interface (e.g., UI **1200A**)

In some embodiments, as illustrated in FIG. **12C**, the image may go through a deletion animation to show the user that the image is being deleted.

This deletion process, which requires gestures by the user on two different user interfaces (e.g., **1200A** and **1200B**) greatly reduces the chance that a user will accidentally delete an image or other similar item.

Image Management

FIGS. **13A** and **13B** illustrate exemplary user interfaces for viewing albums in accordance with some embodiments. In some embodiments, user interface **1300A** includes the following elements, or a subset or superset thereof:

402, 404, and 406, as described above;

Graphics **1304**, e.g., thumbnail images of the first picture or a user-selected picture in the corresponding albums;

Album names **1306**;

32

Selection icons **1308** that when activated (e.g., by a finger tap on the icon) initiates display of the corresponding album (e.g., UI **1500**, FIG. **15**);

Settings icon **1310**, that brings up a settings menu (e.g., FIG. **14**) when activated by a user gesture (e.g., a tap gesture); and

Vertical bar **1314** that helps a user understand what portion of the list of albums is being displayed.

In some embodiments, as shown in FIG. **13B**, one of the photo albums (e.g., **1306-7**) may correspond to the user's photo library; another album (e.g., **1306-8**) may correspond to the camera roll (FIG. **11**); another album (e.g., **1306-9**) may correspond to images added to the photo library in the last 12 months; and other albums (e.g., **1306-10-1306-13**) may correspond to albums created and organized by the user.

The albums may be downloaded on to the device from a wide range of sources, such as the user's desktop or laptop computer, the Internet, etc.

If there is a long list of albums that fill more than the screen area, the user may scroll through the list using vertically upward and/or vertically downward gestures **1312** on the touch screen.

In some embodiments, a user may tap anywhere in the row for a particular album (e.g., a tap on the graphic **1304**, album name **1306**, or selection icon **1308**) to initiate display of the corresponding album (e.g., UI **1500**, FIG. **15**).

In some embodiments, vertical bar **1314** is displayed temporarily after an object is detected on or near the touch screen display (e.g., a finger touch is detected anywhere on the list of albums). In some embodiments, the vertical bar **1314** has a vertical position on top of the displayed portion of the list that corresponds to the vertical position in the list of the displayed portion of the list. In some embodiments, the vertical bar **1314** has a vertical length that corresponds to the portion of the list being displayed. For example, in FIG. **13B**, the vertical position of the vertical bar **1314** indicates that the top of the list of albums is being displayed and the vertical length of the vertical bar **1314** indicates that roughly half of the albums in the list are being displayed.

FIG. **14** illustrates an exemplary user interface for setting user preferences in accordance with some embodiments. In some embodiments, user interface **1400** includes the following elements, or a subset or superset thereof:

402, 404, and 406, as described above;

Music setting **1402** for selecting the music during a slide show (e.g., Now Playing, 90s Music, Recently Added, or Off);

Repeat setting **1404** for selecting whether the slide show repeats (e.g., On or Off);

Shuffle setting **1406** for selecting whether the images in the slide show are put in a random order (e.g., On or Off);

Time per slide setting **1408** (e.g., 2, 3, 5, 10, 20 seconds or manual);

Transition setting **1410** (e.g., random, wipe across, wipe down, or off);

TV out setting **1412** for external display (e.g., on, off, or ask);

TV signal setting **1414** (e.g., NTSC or PAL);

Auto Rotate setting **1416** (e.g. on or off);

Done icon **1418** that when activated (e.g., by a finger tap on the icon) returns the device to the previous UI (e.g., UI **1300**); and

Selection icons **1420** that when activated (e.g., by a finger tap on the icon) show choices for the corresponding settings.

In some embodiments, a user may tap anywhere in the row for a particular setting to initiate display of the corresponding setting choices.

In some embodiments, the settings in FIG. 14 are incorporated into settings **412** (FIG. 4B) and settings icon **1310** need not be displayed in the image management application **144** (e.g., FIG. 13B).

FIG. 15 illustrates an exemplary user interface for viewing an album in accordance with some embodiments. In some embodiments, user interface **1500** includes the following elements, or a subset or superset thereof:

402, **404**, and **406**, as described above;

Photo albums icon **1502** that when activated (e.g., by a finger tap on the icon) initiates transfer to the photo albums UI (e.g., UI **1300B**);

Thumbnail images **1506** of images in the corresponding album;

Play icon **1508** that when activated (e.g., by a finger tap on the icon) initiates a slide show of the images in the album; and

Vertical bar **1514** that helps a user understand what portion of the list of thumbnail images **1506** in an album is being displayed.

In some embodiments, the user may scroll through the thumbnails **1506** using vertically upward and/or vertically downward gestures **1510** on the touch screen. In some embodiments, a stationary gesture on a particular thumbnail (e.g., a tap gesture **1512** on thumbnail **1506-11**) initiates transfer to an enlarged display of the corresponding image (e.g., UI **1600**).

In some embodiments, vertical bar **1514** is displayed temporarily after an object is detected on or near the touch screen display (e.g., a finger touch is detected anywhere on the list of thumbnails). In some embodiments, the vertical bar **1514** has a vertical position on top of the displayed portion of the list that corresponds to the vertical position in the list of the displayed portion of the list. In some embodiments, the vertical bar **1514** has a vertical length that corresponds to the portion of the list being displayed. For example, in FIG. 15, the vertical position of the vertical bar **1514** indicates that the middle of the list of thumbnails is being displayed and the vertical length of the vertical bar **1514** indicates that roughly half of the thumbnails in the album are being displayed.

FIGS. 16A and 16B illustrate exemplary user interfaces for viewing images in an album in accordance with some embodiments. In some embodiments, user interfaces **1600A** and **1600B** include the following elements, or a subset or superset thereof:

402, **404**, and **406**, as described above;

Album name icon **1602** that when activated (e.g., by a finger tap on the icon) initiates transfer to the corresponding album UI (e.g., UI **1500**);

Image **1606**;

Additional options icon **1608** that when activated (e.g., by a finger tap on the icon) initiates transfer to a UI with additional options for use of image **1606** (e.g., UI **1700**, FIG. 17));

Previous image icon **1610** that when activated (e.g., by a finger tap on the icon) initiates display of the previous image in the album (e.g., **1506-10**);

Play icon **1612** that when activated (e.g., by a finger tap on the icon) initiates a slide show of the images in the album; and

Next image icon **1614** that when activated (e.g., by a finger tap on the icon) initiates display of the next image in the album (e.g., **1506-12**).

In some embodiments, icons **1608**, **1610**, **1612**, and **1614** are displayed in response to detecting a gesture on the touch screen (e.g., a single finger tap on the image **1606**) and then cease to be displayed if no interaction with the touch screen is detected after a predetermined time (e.g., 3-5 seconds), thereby providing a “heads up display” effect for these icons.

In some embodiments, the user can also initiate viewing of the previous image by making a tap gesture **1618** on the left side of the image. In some embodiments, the user can also initiate viewing of the previous image by making a swipe gesture **1616** from left to right on the image.

In some embodiments, the user can also initiate viewing of the next image by making a tap gesture **1620** on the right side of the image. In some embodiments, the user can also initiate viewing of the next image by making a swipe gesture **1616** from right to left on the image.

By offering multiple ways to perform the same task (e.g., to view the next image by tapping icon **1614**, tap **1620**, or right to left swipe **1616**), the user can choose whichever way the user prefers, thereby making the UI simpler and more intuitive for the user.

In some embodiments, image **1606** moves off screen to the left as the next image moves on screen from the right. In some embodiments, image **1606** moves off screen to the right as the previous image moves on screen from the left.

In some embodiments, a double tap gesture such as **1618** or **1620** magnifies the image **1606** by a predetermined amount, rather than initiating viewing of another image, so that just a portion of image **1606** is displayed. In some embodiments, when the image is already magnified, repeating the double tap gesture demagnifies the image (e.g., so that the entire image is displayed, or so that the prior view of the image is restored).

In some embodiments, a multi-finger de-pinching gesture magnifies the image **1606** by a variable amount in accordance with the position of the multi-finger de-pinching gesture and the amount of finger movement in the multi-finger de-pinching gesture. In some embodiments, a multi-finger pinching gesture demagnifies the image **1606** by a variable amount in accordance with the position of the multi-finger pinching gesture and the amount of finger movement in the multi-finger pinching gesture.

In some embodiments, if just a portion of image **1606** is displayed, vertical bar **1622** is displayed temporarily after an object is detected on or near the touch screen display (e.g., a finger touch is detected anywhere on the image **1606**). In some embodiments, the vertical bar **1622** has a vertical position on top of the displayed portion of the image that corresponds to the vertical position in the image of the displayed portion of the image. In some embodiments, the vertical bar **1622** has a vertical length that corresponds to the portion of the image being displayed. For example, in FIG. 16A, the vertical position of the vertical bar **1622** indicates that the bottom of the image is being displayed and the vertical length of the vertical bar **1622** indicates that a portion from the bottom half of the image is being displayed.

In some embodiments, if just a portion of image **1606** is displayed, horizontal bar **1624** is displayed temporarily after an object is detected on or near the touch screen display (e.g., a finger touch is detected anywhere on the image **1606**). In some embodiments, the horizontal bar **1624** has a horizontal position on top of the displayed portion of the image that corresponds to the horizontal position in the image of the displayed portion of the image. In some embodiments, the horizontal bar **1624** has a horizontal length that corresponds to the portion of the image being displayed. For example, in FIG. 16A, the horizontal position of the horizontal bar **1224** indicates that a portion of the left side of the image is being

displayed and the horizontal length of the horizontal bar **1624** indicates that a portion from the left half of the image is being displayed. Together, vertical bar **1622** and horizontal bar **1624** indicate that the southwest quadrant of the image **1606** is being displayed.

In some embodiments, in response to detecting a change in orientation of the device **100** from a portrait orientation to a landscape orientation (e.g., using accelerometer **168**), UI **1600A** (including image **1606**) is rotated by 90° to UI **1600B** (FIG. **16B**). In some embodiments, if just a portion of image **1606** is displayed in landscape orientation (UI **1600B**, FIG. **16B**), vertical bar **1628** and horizontal bar **1630** are displayed and act in an analogous manner to vertical bar **1622** and horizontal bar **1624** (UI **1600A**, FIG. **16A**), described above. In some embodiments, in response to detecting a change in orientation of the device **100** from a landscape orientation to a portrait orientation (e.g., using accelerometer **168**), the UI **1600B** is rotated by 90° to UI **1600A** (FIG. **16A**).

In some embodiments, if just a portion of image **1606** is displayed, in response to detecting a finger drag or swipe gesture (e.g., **1626**), the displayed portion of the image is translated in accordance with the direction of the drag or swipe gesture (e.g., vertical, horizontal, or diagonal translation).

FIG. **17** illustrates an exemplary user interface for selecting a use for an image in an album in accordance with some embodiments. In some embodiments, user interface **1700** includes the following elements, or a subset or superset thereof:

402, **404**, **406**, **1602**, and **1606** as described above;

Email photo icon **1708** that when activated (e.g., by a finger tap on the icon) initiates a process for incorporating the image **1606** in an email (e.g., as illustrated in FIGS. **18A-18J**);

Assign to contact icon **1710** that when activated (e.g., by a finger tap on the icon) initiates a process for associating the image **1606** with a contact in the user's contact list (e.g., as illustrated in FIGS. **19A-19B**);

Use as wallpaper icon **1712** that when activated (e.g., by a finger tap on the icon) initiates a process for incorporating the image **1606** in the user's wallpaper (e.g., as illustrated in FIG. **20**); and

Cancel icon **1714** that when activated (e.g., by a finger tap on the icon) initiates transfer back to the previous UI (e.g., UI **1600A**).

FIGS. **18A-18J** illustrate an exemplary user interface for incorporating an image **1606** in an email in accordance with some embodiments.

In response to the user activating Email photo icon **1708**, the device displays an animation to show that the image has been placed into an email message, ready for text input, addressing, and sending. In some embodiments, the animation includes initially shrinking the image (FIG. **18A**); sliding or otherwise forming an email message template behind the image **1606** (FIG. **18B**); and expanding the image (FIG. **18C**).

In some embodiments, if the user makes a tap or other predefined gesture on the subject line **1804** or in the body of the email **1806** (FIG. **18D**), a letter keyboard **616** appears and the user may input the subject and/or body text (FIG. **18E**).

In some embodiments, to enter the email address, the user makes a tap or other predefined gesture on the To: line **1802** of the email (FIG. **18E**); the user's contact list appears (FIG. **18J**); the user makes a tap or other predefined gesture on the desired recipient/contact (e.g., tapping **1816** on Bob Adams in FIG. **18J**); and the device places the corresponding email address in the email message (FIG. **18G**). If others need to be copied on the email, the user makes a tap or other predefined

gesture on the CC: line **1818** of the email; the user's contact list appears (FIG. **18J**); the user makes a tap or other predefined gesture on the desired recipient/contact (e.g., tapping **1820** on Darin Adler in FIG. **18J**); and the device places the corresponding email address in the email message (FIG. **18G**).

In some embodiments, to enter the email address, the user makes a tap or other predefined gesture on the To: line **1802** of the email (FIG. **18E**). Add recipient icon **1822** appears, which when activated (e.g., by a finger tap on the icon **1822**) initiates the display of a scrollable list of contacts (e.g., **1826**, FIG. **18F**) that match the input, if any, in the To: field. For example, if the letter "B" is input, then contacts with either a first name or last name beginning with "B" are shown. If the letters "Bo" are input in the To: field, then the list of contacts is narrowed to contacts with either a first name or last name beginning with "Bo", and so on until one of the displayed contacts is selected (e.g., by a tap on a contact in the list **1826**, FIG. **18F**). If others need to be copied on the email, the user makes a tap or other predefined gesture on the CC: line **1818** of the email and follows an analogous procedure to that used for inputting addresses in the To: field.

In some embodiments, a user can scroll through the list **1826** by applying a vertical swipe gesture **1828** to the area displaying the list **1826** (FIG. **18F**). In some embodiments, a vertically downward gesture scrolls the list downward and a vertically upward gesture scrolls the list upward.

In some embodiments, a vertical bar **1830** (FIG. **18F**) is displayed temporarily after an object is detected on or near the touch screen display (e.g., a finger touch is detected anywhere on the list **1826**). In some embodiments, the vertical bar **1830** has a vertical position on top of the displayed portion of the list that corresponds to the vertical position in the list of the displayed portion of the list. In some embodiments, the vertical bar **1830** has a vertical length that corresponds to the portion of the list being displayed.

In some embodiments, the user may also enter the email address using one or more keyboards (e.g., **616** and **624**, not shown).

In some embodiments, as the user types the email message, a suggested word **1832** appears adjacent to the word being typed and/or in the space bar **1834** (FIG. **18G**). Activating suggested word **1832** (e.g., by a finger tap on the suggested word) replaces the word being typed with the suggested word **1832** (FIG. **18H**). Activating suggested word **1834** (e.g., by a finger tap on the space bar) replaces the word being typed with the suggested word **1834** (FIG. **18H**). In some embodiments, a user can set whether suggested words **1832** and/or **1834** are shown (e.g., by setting a user preference). Additional descriptions of word suggestion can be found in U.S. patent application Ser. No. 11/620,641, "Method, System, And Graphical User Interface For Providing Word Recommendations for Text Input," filed Jan. 5, 2007) and U.S. patent application Ser. No. 11/620,642, "Method, System, And Graphical User Interface For Providing Word Recommendations," filed Jan. 5, 2007, the contents of which are hereby incorporated by reference in their entirety.

In some embodiments, a vertical bar **1836** (FIG. **18H**), analogous to the vertical bars described above, is displayed on top of the body of the email that helps a user understand what portion of the email is being displayed.

The device sends the email message in response to the user activating the send icon **1814** (FIG. **18I**) (e.g., by a finger tap on the icon). Alternatively, if the user activates the cancel icon **1808**, the device may display the save draft icon **1810**, the don't save (or delete message) icon **1812**, and the edit message icon **1890**. The device saves the draft if the user activates

the save draft icon **1810**, e.g., in a drafts folder in email client **140** (FIG. **33**). The device deletes the draft if the user activates the don't save icon **1812**. The device returns to editing the draft if the user activates the edit message icon **1890**.

FIGS. **19A** and **19B** illustrate an exemplary user interface for assigning an image **1606** to a contact in the user's contact list in accordance with some embodiments.

In some embodiments, in response to the user activating assign to contact icon **1710** (FIG. **17**), the device displays the user's contact list (FIG. **19A**). In response to the user selecting a contact in the contact list (e.g., selecting Bob Adams with a tap **1901** in UI **1900A**, FIG. **19A**), the device displays a user interface (e.g., UI **1900B**, FIG. **19B**) that lets the user crop, scale, and otherwise adjust the image for the selected contact. In some embodiments, the user may move the image with a one-finger gesture **1908**; enlarge the image with a de-pinch gesture using multiple contacts **1910** and **1912**; reduce the image with a pinching gesture using multiple contacts **1910** and **1912**; and/or rotate the image with a twisting gesture using multiple contacts **1910** and **1912**. In some embodiments, in response to the user activating a set photo icon **1906**, the device assigns the adjusted image to the selected contact. Alternatively, in response to the user activating a cancel icon **1904**, the device stops the assignment process. In some embodiments, the interface **1900B** may include information **1902** to help guide the user.

FIG. **20** illustrates an exemplary user interface for incorporating an image **1606** in the user's wallpaper in accordance with some embodiments.

In some embodiments, in response to the user activating use as wallpaper icon **1712** (FIG. **17**), the device displays a user interface (e.g., UI **2000**, FIG. **20**) that lets the user crop, scale, and otherwise adjust the image. In some embodiments, the user may move the image with a one-finger gesture **2008**; enlarge the image with a de-pinch gesture using multiple contacts **2010** and **2012**; reduce the image with a pinching gesture using multiple contacts **2010** and **2012**; and/or rotate the image with a twisting gesture using multiple contacts **2010** and **2012**. In some embodiments, in response to the user activating a set wallpaper icon **2006**, the device assigns the adjusted image as wallpaper. Alternatively, in response to the user activating a cancel icon **2004**, the device stops the assignment process. In some embodiments, the interface **2000** may include information **2002** to help guide the user.

Additional description of image management can be found in U.S. Provisional Patent Application Nos. 60/883,785, "Portable Electronic Device For Photo Management," filed Jan. 6, 2007, and 60/947,118, "Portable Electronic Device For Photo Management," filed Jun. 29, 2007, and U.S. patent application Ser. No. 11/848,210, "Portable Electronic Device For Photo Management," filed Aug. 30, 2007, the contents of which are hereby incorporated by reference in their entirety.

Video Player

FIGS. **21A-21C** illustrate an exemplary user interface for organizing and managing videos in accordance with some embodiments.

In some embodiments, in response to a series of gestures (e.g., finger taps) by the user, the device displays a series of video categories and sub-categories. For example, if the user activates selection icon **2101** (e.g., by a finger tap on the icon) or, in some embodiments, taps anywhere in the Playlists row **2108**, the UI changes from a display of video categories (UI **2100A**, FIG. **21A**) to a display of Playlist sub-categories (UI **2100B**, FIG. **21B**). In turn, if the user activates the selection icon for My Movies (e.g., by a finger tap on the icon) or, in some embodiments, taps anywhere in the My Movies row

2110, the UI changes from a display of Playlist sub-categories (UI **2100B**, FIG. **21B**) to a display of My Movies sub-categories (UI **2100C**, FIG. **21C**), and so forth.

In some embodiments, in response to a series of gestures (e.g., finger taps) by the user, the device navigates back up through the hierarchy of video categories and sub-categories. For example, if the user activates Playlists icon **2106** (e.g., by a finger tap on the icon), the UI changes from a display of My Movies sub-categories (UI **2100C**, FIG. **21C**) to a display of Playlist sub-categories (UI **2100B**, FIG. **21B**). In turn, if the user activates the Videos icon **2104** (e.g., by a finger tap on the icon), the UI changes from a display of Playlist sub-categories (UI **2100B**, FIG. **21B**) to a display of video categories (UI **2100A**, FIG. **21A**). As another example, if the device detects a horizontal swipe gesture (e.g., a left to right swipe gesture), the device may navigate up one level in the hierarchy of video categories and sub-categories. More generally, in response to detecting a horizontal swipe gesture (e.g., a left to right swipe gesture), the device may navigate up one level in a hierarchy of content categories, sub-categories, and content (e.g., from UI **4300 S** (FIG. **43S**) for an individual song to a UI **4300R** (FIG. **43R**) for an album; from UI **4300R** (FIG. **43R**) for an album to UI **4300Q** for a list of albums; and so on).

In some embodiments, in response to user selection of a particular video (e.g., by a tap or other predefined gesture on the graphic, title, or anywhere **2112** (FIG. **21C**) in the row for a particular video), the device displays the selected video (e.g., King Kong) in a video player UI (e.g., UI **2300A**, FIG. **23A**).

In some embodiments, in response to user selection of settings icon **2102** (e.g., by a finger tap on the icon), the device displays a settings UI (UI **2200A**, FIG. **22A**) for a video player.

FIGS. **22A** and **22B** illustrate an exemplary user interface for setting user preferences for a video player in accordance with some embodiments.

In some embodiments, a user may make a tap or other predefined gesture anywhere in a row for a particular setting to initiate display of the corresponding setting choices. For example, in response to a tap **2202** on the Scale to fit setting (UI **2200A**, FIG. **22A**), the device displays the setting choices for scale to fit (UI **2200B**, FIG. **22B**).

In some embodiments, user interface **2200B** includes the following elements, or a subset or superset thereof:

402, **404**, and **406**, as described above;

Settings icon **2204** that when activated (e.g., by a finger tap on the icon) returns the device to the settings UI (e.g., UI **2200A**);

Scale to fit icon **2206** that when activated (e.g., by a finger tap on the icon) sets the video player to scale the video to fit into the touch screen **112** ("wide screen mode"), which may result in two horizontal black bands at the top and bottom of the display for wide-screen movies;

Scale to full icon **2208** that when activated (e.g., by a finger tap on the icon) sets the video player to fill the touch screen **112** with the video ("full screen mode");

Cancel icon **2210** that when activated (e.g., by a finger tap on the icon) returns the device to the previous UI (e.g., UI **2200A**) without saving any changes selected by the user; and

Done icon **2212** that when activated (e.g., by a finger tap on the icon) saves the setting selected by the user and returns the device to the previous UI (e.g., UI **2200A**);

In some embodiments, the settings in FIG. **22A** are incorporated into settings **412** (FIG. **4B**) and settings icon **2102** need not be displayed in the video application **145** (e.g., FIG. **21A-21C**). In some embodiments, the settings in FIG. **22A**

are incorporated into the video player UI (e.g., as wide screen selector icon **2326** in FIG. **23C** and full screen selector icon **2328** in FIG. **23D**).

In some embodiments, a vertical bar analogous to the vertical bars described above, is displayed on top of a list of video categories (e.g., FIG. **21A**), a list of subcategories (e.g., FIG. **21B**), and/or a list of videos (e.g., FIG. **21C**) that helps a user understand what portion of the respective list is being displayed. In some embodiments, if an entire list can be displayed simultaneously on the touch screen **112**, the vertical bar is not displayed.

FIGS. **23A-23D** illustrate exemplary user interfaces for a video player in accordance with some embodiments. In some embodiments, user interfaces **2300A-2300D** include the following elements, or a subset or superset thereof:

402, **404**, and **406**, as described above;

Video **2302**

Play icon **2304** that when activated (e.g., by a finger tap on the icon) initiates playing the video **2302**, either from the beginning or from where the video was paused;

Pause icon **2306** that when activated (e.g., by a finger tap on the icon) initiates pausing the video **2302**;

Lapsed time **2308** that shows how much of the video has been played, in units of time;

Progress bar **2310** that indicates what fraction of the video has been played and that may be used to help scroll through the video in response to a user gesture;

Remaining time **2312** that shows how much of the video remains to be played, in units of time;

Exit (Done) icon **2314** that when activated (e.g., by a finger tap on the icon) initiates exiting the video player UI (e.g., UI **2300A**) and returning to another UI (e.g., UI **2100C**, FIG. **2100C**);

Enlarged lapsed time **2318** that may appear in response to a user gesture **2316** involving progress bar **2310**;

Fast Reverse/Skip Backwards icon **2320** that when activated (e.g., by a finger tap on the icon) initiates reversing or skipping backwards through the video **2302**;

Fast Forward/Skip Forward icon **2322** that when activated (e.g., by a finger tap on the icon) initiates forwarding or skipping forwards through the video **2302**;

Volume adjustment slider icon **2324** that that when activated (e.g., by a finger tap on the icon) initiates adjustment of the volume of the video **2302**;

Wide screen selector icon **2326** that when activated (e.g., by a finger tap on the icon) initiates display of the video in wide screen mode and toggles to icon **2328**; and

Full screen selector icon **2328** that when activated (e.g., by a finger tap on the icon) initiates display of the video in full screen mode and toggles to icon **2326**.

In some embodiments, in response to user selection of a particular video (e.g., by a tap or other predefined gesture on the graphic, title, or anywhere **2112** in the row for a particular video in UI **2100C**), the device displays the selected video (e.g., King Kong) in a video player UI (e.g., UI **2300A**). In some embodiments, the device automatically displays the video in landscape mode on the touch screen, rather than in portrait mode, to increase the size of the image on the touch screen.

In some embodiments, graphics other than the video **2302** (e.g., graphics **2304**, **2306**, **2308**, **2310**, **2312**, **2314**, **2320**, **2322**, **2326** and/or **2328**) may fade out if there is no contact with the touch screen **112** for a predefined time. In some embodiments, these graphics may reappear if contact is made with the touch screen, thereby producing a "heads up display" effect for these graphics. In some embodiments, for wide screen movies displayed in fit-to-screen mode, graphics may

be displayed in the black horizontal bands above and below the video **2302**, to avoid obscuring the video.

In some embodiments, in response to a user gesture, the lapsed time in the video can be modified. For example, in response to the user's finger touching **2316** at or near the end of the progress bar and then sliding along the progress bar, the lapsed time may be altered to correspond to the position of the user's finger along the progress bar. In some embodiments, enlarged lapsed time **2318** is displayed during this user gesture to indicate where the video will resume playing when the gesture is ended (FIG. **23B**). In some embodiments, one or more still images from the video **2302** that correspond to where the video will resume playing are displayed as the user's finger is moved along the progress bar. This user gesture on the progress bar makes it easy for a user to select a particular scene in a video for viewing.

Additional description of a video player and manager can be found in U.S. Provisional Patent Application Nos. 60/883,784, "Video Manager For Portable Multifunction Device," filed Jan. 6, 2007, and 60/946,973, "Video Manager For Portable Multifunction Device," filed Jun. 28, 2007, and U.S. patent application Ser. No. 11/850,008, "Video Manager For Portable Multifunction Device," filed Sep. 4, 2007, the contents of which are hereby incorporated by reference in their entirety.

Weather

FIGS. **24A-24E** illustrate an exemplary user interface for displaying and managing weather widgets in accordance with some embodiments.

In some embodiments, weather widgets **149-1** (FIG. **4A**) display the weather for particular locations (e.g., Santa Cruz, Calif. in UI **2400A**, FIG. **24A** or Cupertino, Calif. in UI **2400E**, FIG. **24E**). In response to the user activating settings icon **2402** (e.g., by a finger tap on the icon), the settings UI for the weather widgets is displayed (e.g., UI **2400B**, FIG. **24B**). In some embodiments, the user can select the particular location for display with a gesture (e.g., by touching the particular location in a list **2412** of locations, which may highlight the selected location). In some embodiments, the settings in FIG. **24B** are incorporated into settings **412** (FIG. **4B**) and settings icon **2402** need not be displayed in the weather widget (e.g., FIG. **24A**).

In some embodiments, in response to the user's finger contacting **2404** (FIG. **24B**) a text entry box, a keyboard (e.g., **616**) is displayed (UI **2400C**, FIG. **24C**). In some embodiments, a word suggestion area **622** is also displayed. In response to the user entering the new location and activating the add location icon **2406**, the new location is added to the list of locations.

In some embodiments, the highlighted location in the list of locations is removed if the user activates the remove icon **2408** (e.g., by a finger tap on the icon). In some embodiments, in response to the user activating the done icon **2410**, the device displays the weather for the selected location (e.g., UI **2400A**, FIG. **24A**).

In some embodiments, for each location in the list of locations, a corresponding icon **2414** is added to the UI that displays the weather for a particular location (e.g., UI **2400A**). For example, because there are four locations in the settings UI **2400B**, four icons **2414** are displayed in UI **2400A**, FIG. **24A**. In some embodiments, the icon **2414** that corresponds to the location whose weather is being displayed may be highlighted to distinguish it from the other icons. For example, Santa Cruz, the third of four locations set by the user, is highlighted in UI **2400B** and the weather for Santa Cruz is displayed in UI **2400A**. Thus, the third of four icons

US 7,479,949 B2

41

2414 (i.e., **2414-3**) is highlighted in UI **2400A**. The icons **2414** let a user know at a glance how many locations are listed in the settings menu **2400B** and which location in the list is displayed.

In some embodiments, the user can initiate viewing of the previous location in the list (e.g., Cupertino, Calif.) by making a swipe gesture **2416** from left to right on the touch screen. In some embodiments, the user can initiate viewing of the next location in the list (e.g., New York, N.Y.) by making a swipe gesture **2416** from right to left on the touch screen. For this example, if the weather for Cupertino, Calif. is displayed, then icon **2414-2** is highlighted (FIG. **24E**). Similarly, if the weather for New York, N.Y. is displayed, then icon **2414-4** is highlighted.

The weather widgets **149-1** are an example of widgets with a single, shared settings/configuration page that provides settings for multiple widgets for display.

In some embodiments, a portable multifunction device displays a widget (e.g., Santa Cruz weather widget, FIG. **24A**) on a touch screen display. The displayed widget is one of a set of widgets that share a common configuration interface (e.g., FIG. **24B**). In some embodiments, widgets in the set of widgets are displayed one at a time (e.g., FIG. **24A** and FIG. **24E**).

One or more widget set indicia icons (e.g., icons **2414**, FIG. **24A**) are displayed. The widget set indicia icons provide information about the number of widgets in the set of widgets and a position of the displayed widget in the set of widgets. In some embodiments, the one or more widget set indicia icons are displayed concurrently with the displayed widget (e.g., FIG. **24A**).

A finger gesture is detected on the touch screen display. In some embodiments, the finger gesture is a swipe gesture (e.g., swipe **2416**, FIG. **24A**).

In response to the finger gesture, the displayed widget (e.g., Santa Cruz weather widget, FIG. **24A**) is replaced with another widget (e.g., Cupertino weather widget, FIG. **24E**) in the set of widgets, and information provided by the widget set indicia icons is updated to reflect the replacement of the displayed widget by another widget in the set of widgets. In some embodiments, the set of widget form a sequence and the displayed widget is replaced by an adjacent widget in the sequence of widgets.

A graphical user interface on a portable communications device with a touch screen display comprises a set of widgets that share a common configuration interface, and one or more widget set indicia icons (e.g., **2414**). At most one widget in the set of widgets is shown on the touch screen at any one time (e.g., Santa Cruz weather widget, FIG. **24A**). The widget set indicia icons provide information about the number of widgets in the set of widgets and a position of the displayed widget in the set of widgets. In response to detecting a finger gesture (e.g., **2416**) on the touch screen display, a displayed widget is replaced with another widget in the set of widgets, and the information provided by the widget set indicia icons is updated to reflect the replacement of the displayed widget by another widget in the set of widgets.

In some embodiments, a portable multifunction device (e.g., device **100**) displays a first widget on a touch screen display (e.g., Santa Cruz weather widget, FIG. **24A**).

A first gesture is detected on the touch screen on a settings icon (e.g., **2402**, FIG. **24A**) on the first widget. In some embodiments, the first gesture is a tap gesture by a finger of the user.

In response to the first gesture, settings are displayed that are adjustable by a user for a plurality of widgets, including settings for the first widget (e.g., FIG. **24B**). In some embodi-

42

ments, in response to the first gesture, an animated transition from the first widget to the settings for the plurality of widgets is displayed. In some embodiments, the plurality of widgets provide weather information for a corresponding plurality of locations.

One or more additional gestures to change one or more settings for one or more widgets in the plurality of widgets are detected.

In response to the one or more additional gestures, one or more settings for one or more widgets in the plurality of widgets are changed, including changing one or more settings for a respective widget in the plurality of widgets other than the first widget.

A widget selection gesture and a finishing gesture are detected on the touch screen display. In some embodiments, the finishing gesture is a tap gesture on a finish icon (e.g., icon **2410**, FIG. **24B**). In some embodiments, the finish icon is a “done” icon, an “okay” icon, or a “save” icon. In some embodiments, the widget selection gesture and the finishing gesture are a single combined gesture. In some embodiments, the single combined gesture is a double tap gesture.

In response to the widget selection gesture and the finishing gesture, a second widget in the plurality of widgets other than the first widget is displayed (e.g., Cupertino weather widget, FIG. **24E**).

A graphical user interface on a portable multifunction device with a touch screen display comprises a plurality of widgets, wherein at most one widget is shown on the touch screen at any one time, and settings for the plurality of widgets. In response to a first gesture on a settings icon on a first widget in the plurality of widgets, settings that are adjustable by a user for the plurality of widgets are displayed, including settings for the first widget. In response to one or more additional gestures, one or more settings for one or more widgets in the plurality of widgets, including one or more settings for a respective widget in the plurality of widgets other than the first widget, are changed. In response to a widget selection gesture and a finishing gesture, the changed settings are saved and a second widget in the plurality of widgets other than the first widget is displayed.

In some embodiments, for weather and other applications with a location-based component, the device may automatically provide current location information (e.g., determined by GPS module **135**) to the application. Thus, in some embodiments, the weather widget may provide the weather information for the current location of the device, without the user having to explicitly input the name or zip code of the current location. Similarly, current location information may be automatically provided to widgets and other applications for finding and/or interacting with stores, restaurants, maps, and the like near the current location of the device.

Additional description of configuring and displaying widgets can be found in U.S. Provisional Patent Application No. 60/946,975, “Portable Multifunction Device, Method, and Graphical User Interface for Configuring and Displaying Widgets,” filed Jun. 28, 2007, and U.S. patent application Ser. No. 11/850,010, “Portable Multifunction Device, Method, and Graphical User Interface for Configuring and Displaying Widgets,” filed Sep. 4, 2007, the content of which is hereby incorporated by reference in its entirety.

Stocks

FIGS. **25A-25E** illustrate an exemplary user interface for displaying and managing a stocks widget in accordance with some embodiments.

In some embodiments, stocks widget **149-2** displays information for a number of user-selected stocks (e.g., UI **2500A**,

FIG. 25A). In some embodiments, in response to a user gesture, the information displayed is changed. For example, in response to the user touching **2504** the column with absolute gains and losses (UI **2500A**, FIG. 25A), the percentage gains and losses may be displayed instead (UI **2500B**, FIG. 25B). For example, in response to the user touching “1 w”, the one-week chart for the highlighted stock (INDU) may be displayed (not shown) instead of the six-month chart (“6 m”).

In some embodiments, in response to the user activating settings icon **2502** (e.g., by a finger tap on the icon), the settings UI for the stocks widget is displayed (e.g., UI **2500C**, FIG. 25C).

In some embodiments, in response to the user’s finger contacting **2506** a text entry box, a keyboard (e.g., **616**) is displayed (UI **2500D**, FIG. 25D). In some embodiments, a word suggestion area **622** is also displayed. In response to the user entering the symbol or name of the new stock and activating the add stock icon **2508**, the new stock is added to the list of stocks.

In some embodiments, the highlighted stock in the list of stocks **2510** is removed if the user activates the remove icon **2512** (e.g., by a finger tap on the icon). In some embodiments, in response to the user activating the done icon **2514**, the device displays the stock information for the selected stocks (e.g., UI **2500A**, FIG. 25A).

Telephone

FIGS. 26A-26P illustrate an exemplary user interface for displaying and managing contacts in accordance with some embodiments.

In some embodiments, in response to the user activating phone icon **138** in UI **400** (FIG. 4) (e.g., by a finger tap on the icon), the user’s contact list is displayed (e.g., UI **2600A**, FIG. 26A).

As described in U.S. patent application Ser. No. 11/322, 547, “Scrolling List With Floating Adjacent Index Symbols,” filed Dec. 23, 2005, which is hereby incorporated by reference in its entirety, the user may scroll through the contact list using vertically upward and/or vertically downward gestures **2602** on the touch screen.

In some embodiments, in response to the user activating add new contact icon **2604** (e.g., by a finger tap on the icon), the touch screen displays a user interface for editing the name of the contact (e.g., UI **2600B**, FIG. 26B).

In some embodiments, in response to the user entering the contact name (e.g., entering “Ron Smith” via keyboard **616** in UI **2600C**, FIG. 26C) and activating the save icon **2606** (e.g., by a finger tap on the icon), the contacts module creates and displays a new entry for the contact (e.g., UI **2600D**, FIG. 26D).

In some embodiments, in response to the user activating add photo icon **2607** (e.g., by a finger tap on the icon), the touch screen displays a user interface for adding a photograph or other image to the contact (e.g., UI **2600E**, FIG. 26E). In response to the user activating take photo icon **2670** (e.g., by a finger tap on the icon), the camera **143** is activated, and a photograph is taken and associated with the contact (e.g., using a process like that described with respect to FIG. 19B above). In response to the user activating the choose existing photo icon **2672** (e.g., by a finger tap on the icon), the photo management application **144** is activated, and a photograph is selected, adjusted, and associated with the contact. In response to the user activating the cancel icon **2674** (e.g., by a finger tap on the icon), the process of associating a photograph or other image with the contact is stopped.

In some embodiments, in response to the user activating add new phone icon **2608** (e.g., by a finger tap on the icon or

on the row containing the icon), the touch screen displays a user interface for editing the phone number(s) of the contact (e.g., UI **2600F**, FIG. 26F). In some embodiments, a keypad selection key (e.g., the “+*#” key in FIG. 26F) is used to toggle the UI to UI **2600P** (FIG. 26P) so that the user may enter other symbols or a pause in the phone number. In some embodiments, a second keypad selection key (e.g., the “123” key in FIG. 26P) is used to toggle UI **2600P** back to the numeric keypad in the previous UI (e.g., UI **2600F**, FIG. 26F).

In some embodiments, in response to the user entering the phone number (e.g., via keyboard **2676** in UI **2600F**, FIG. 26F); specifying the type of phone number (e.g., by a tap or other predefined gesture on home icon **2620** or selection icon **2624**); and activating the save icon **2626** (FIG. 26P) (e.g., by a finger tap on the icon), the contacts module creates a phone number for the corresponding contact.

In some embodiments, the user can select additional phone number types. For example, in response to the user activating selection icon **2624** (e.g., by a finger tap on the icon), the touch screen displays a phone label UI (e.g., UI **2600G**, FIG. 26G). In some embodiments, in response to the user activating a label in UI **2600G**, the chosen label is displayed in place of home icon **2620** in UI **2600F**. In some embodiments, the chosen label is also highlighted in UI **2600F** to indicate to the user that the phone number being entered will be given the chosen label.

In some embodiments, the user can add custom phone labels to UI **2600F** by activating the add labels icon **2628** (FIG. 26G) and entering the via label via a soft keyboard (e.g., **616**, not shown).

In some embodiments, the user can delete one or more of the labels in UI **2600G**. In some embodiments, only the user’s custom labels may be deleted. For example, in response to the user activating the edit icon **2630** (e.g., by a finger tap on the icon), the touch screen displays a delete icon **2632** next to the labels that may be deleted (e.g., UI **2600H**, FIG. 26H). If a user activates a delete icon (e.g., by tapping it with a finger), the icon may rotate 90 degrees (e.g., **2634**, FIG. 26I) or otherwise change its appearance and/or a second icon may appear (e.g., remove/confirm delete icon **2636**, FIG. 26I). If the user activates the second icon, the contact module deletes the corresponding label. This deletion process is analogous to the process described above with respect to FIG. 7. As noted above, a deletion process that requires multiple gestures by the user on different parts of the touch screen (e.g., delete icon **2634** and remove/confirm delete icon **2636** are on opposite sides of the touch screen in UI **2600I**) greatly reduces the chance that a user will accidentally delete a label or other similar item. The user activates the done icon **2638** (e.g., by tapping on it with a finger) when the user has finished deleting labels and the device returns to UI **2600G**.

In some embodiments, in response to the user activating add new email icon **2610** in UI **2600D**, FIG. 26D (e.g., by a finger tap on the icon or on the row containing the icon), the touch screen displays a user interface for editing the email address(es) of the contact (e.g., UI **2600J**, FIG. 26J). In some embodiments, the keyboard **2601** (FIG. 26J) for entering an email address has no space bar (because email addresses do not contain spaces). Instead, the area in the keyboard that would typically contain a space bar contains an “@” key **2603**, a period key **2605**, and a “.com” key **2609**. Because all email addresses contain “@” and “.”, and many email addresses include “.com”, including these keys in keyboard **2601** makes entering email addresses faster and easier.

In some embodiments, in response to the user entering the email address (e.g., via keyboard **2601** in UI **2600J**, FIG. 26J); specifying the type of email address (e.g., by a tap or other

predefined gesture on home icon or selection icon **2646**); and activating the save icon **2648** (e.g., by a finger tap on the icon), the contacts module creates an email address for the corresponding contact.

In some embodiments, the user can select additional email address types by activating selection icon **2646**; add custom email address types, and/or delete email address types using processes and UIs analogous to those described for phone number types (FIGS. **26G-26I**).

In some embodiments, in response to the user activating add new URL icon **2611** in UI **2600D**, FIG. **26D** (e.g., by a finger tap on the icon or on the row containing the icon), the touch screen displays a user interface for editing the URLs of the contact (e.g., UI **2600K**, FIG. **26K**).

In some embodiments, in response to the user entering the URL (e.g., via keyboard **616** in UI **2600K**, FIG. **26K**); specifying the type of URL (e.g., by a tap or other predefined gesture on home page icon **2678** or selection icon **2680**); and activating the save icon **2648** (e.g., by a finger tap on the icon), the contacts module creates a URL for the corresponding contact.

In some embodiments, the user can select additional URL types by activating selection icon **2680**; add custom URL types, and/or delete URL types using processes and UIs analogous to those described for phone number types (FIGS. **26G-26I**).

In some embodiments, in response to the user activating add new address icon **2612** in UI **2600D**, FIG. **26D** (e.g., by a finger tap on the icon or on the row containing the icon), the touch screen displays a user interface for editing the physical address(es) of the contact (e.g., UI **2600L**, FIG. **26L**).

In some embodiments, in response to the user entering the address (e.g., via keyboard **616** in UI **2600L**, FIG. **26L**); specifying the type of address (e.g., by a tap or other predefined gesture on work icon **2652** or selection icon **2656**); and activating the save icon **2658** (e.g., by a finger tap on the icon), the contacts module creates an address for the corresponding contact. In some embodiments, in response to detecting a gesture on the zip code field **2654**, display of keyboard **616** is ceased and a numerical keyboard **624** (FIG. **6C**) is displayed, to allow the user to provide numerical input to the zip code field **2654**.

In some embodiments, the user can select additional address types by activating selection icon **2656**; add custom address types, and/or delete address types using processes and UIs analogous to those described for phone number types (FIGS. **26G-26I**).

FIG. **26M**, UI **2600M**, illustrates an exemplary user interface for an existing contact list entry in accordance with some embodiments. In response to the user selecting edit icon **2664** (e.g., by a finger tap on the icon), the touch screen displays a user interface for editing the contact (e.g., UI **2600O**, FIG. **26O**). In response to user selections, the contact list module may delete one or more items of existing contact information, add new phone numbers, add new email addresses, add new physical addresses, and/or add new URLs using the processes and UIs described above (e.g., FIGS. **26E-26L**).

In response to the user selecting text message icon **2682** in FIG. **26M** (e.g., by a finger tap on the icon), the touch screen displays a user interface (e.g., UI **2600N**, FIG. **26N**) for choosing a phone number associated with the contact for a text message or other instant message, such as the contact's work number **2686** or home number **2688**. In response to the user selecting one of the contact's phone numbers, the touch screen displays a UI for creating and sending a message to the selected phone number (e.g., UI **600A** in FIG. **6A**).

In response to the user selecting add to favorites icon **2684** in FIG. **26M** (e.g., by a finger tap on the icon), the contact is added to the list of favorites (e.g., UI **2700A**, FIG. **27A**).

FIGS. **27A-27F** illustrate an exemplary user interface for displaying and managing favorite contacts in accordance with some embodiments. UI **2700A** displays an exemplary list of favorites. In some embodiments, each row in the list that corresponds to a favorite includes the name **2702** of the favorite, the type of phone number **2704** for the favorite that will be called, and an additional information icon **2706**. In some embodiments, in response to the user activating icon **2706** for a particular favorite (e.g., by a finger tap on the icon), the touch screen displays the corresponding contact list entry for that favorite (e.g., UI **2600M**, FIG. **26M**). In some embodiments, in response to a user tap or other predefined gesture elsewhere (i.e., a tap or gesture other than on icon **2702**) in the row corresponding to a particular favorite, the phone module dials the corresponding phone number **2704** for that particular favorite.

In some embodiments, in response to the user activating add favorite icon **2708** (e.g., by a finger tap on the icon), the device displays the user's contact list, from which the user selects the contact list entry for a new favorite and a phone number in the entry for the new favorite.

In some embodiments, in response to the user activating the edit icon **2710** (e.g., by a finger tap on the icon), the touch screen displays a delete icon **2712** and/or a moving-affordance icon **2720** next to the favorites (e.g., UI **2700B**, FIG. **27B**).

If a user activates a delete icon (e.g., by tapping it with a finger), the icon may rotate 90 degrees (e.g., **2714**, FIG. **27C**) or otherwise change its appearance and/or a second icon may appear (e.g., remove/confirm delete icon **2716**, FIG. **27C**). If the user activates the second icon, the corresponding favorite is deleted. This deletion process is analogous to the process described above with respect to FIGS. **7** and **26H** and **26I**. As noted above, a deletion process that requires multiple gestures by the user on different parts of the touch screen (e.g., delete icon **2714** and remove/confirm delete icon **2716** are on opposite sides of the touch screen in UI **2700C**) greatly reduces the chance that a user will accidentally delete a favorite or other similar item. The user activates the done icon **2718** (e.g., by tapping on it with a finger) when the user has finished deleting favorites and the device returns to UI **2700A**.

If a user activates a moving-affordance icon **2720** (e.g., by contacting it with a finger **2722**), the corresponding favorite may be repositioned in the list of favorites, as illustrated in FIGS. **27D-27F**. The user activates the done icon **2718** (e.g., by tapping on it with a finger) when the user has finished reordering the favorites and the device returns to UI **2700A**.

Additional description of the reordering of user-configurable lists can be found in U.S. Provisional Patent Application No. 60/883,808, "System And Method For Managing Lists," filed Jan. 7, 2007, and U.S. patent application Ser. No. 11/770,725, "System and Method for Managing Lists," filed Jun. 28, 2007, the contents of which are hereby incorporated by reference in their entirety.

FIGS. **28A-28D** illustrate an exemplary user interface for displaying and managing recent calls in accordance with some embodiments.

In some embodiments, in response to the user activating All icon **2810**, the touch screen displays a list of all recent calls (e.g., UI **2800A**, FIG. **28A**). In some embodiments, in response to the user activating Missed icon **2812**, the touch screen displays a list of recent missed calls (e.g., UI **2800B**, FIG. **28B**).

US 7,479,949 B2

47

In some embodiments, each row in a list corresponds to a call or a consecutive sequence of calls involving the same person or the same number (without an intervening call involving another person or another phone number). In some embodiments, each row includes: the name **2802** of the other party (if available via the contact module) or the phone number (if the name of the other party is not available); the number **2804** of consecutive calls; the date and/or time **2806** of the last call; and an additional information icon **2808**. In some embodiments, in response to the user activating icon **2808** for a particular row (e.g., by a finger tap on the icon), the touch screen displays the corresponding contact list entry for the other party (e.g., UI **2800C**, FIG. **28C**) or UI **2800D** (FIG. **28D**) if the phone number cannot be associated with an entry in the user's contact list. In some embodiments, in response to a user tap or other predefined gesture elsewhere (i.e., a tap or gesture other than on icon **2808**) in a given row, the phone module dials the corresponding phone number for that row.

In some embodiments, some rows may include icons indicating whether the last call associated with the row was missed or answered.

If the list of recent calls fills more than the screen area, the user may scroll through the list using vertically upward and/or vertically downward gestures **2814** on the touch screen.

In some embodiments, UI **2800C** highlights (e.g., with color, shading, and/or bolding) the phone number associated with the recent call (e.g., the two recent incoming calls from Bruce Walker in UI **2800A** came from Bruce Walker's work number **2816**). In some embodiments, in response to a user tap or other predefined gesture on the highlighted number **2816**, the phone module dials the highlighted number (e.g., **2816**). In some embodiments, in response to a user tap or other predefined gesture on another number in the contact list entry (e.g., home number **2818**), the phone module dials the corresponding number. In some embodiments, in response to a user tap or other predefined gesture on an email address in the contact list entry (e.g., either work email **2820** or home email **2822**), the email module prepares an email message with the selected email address, ready for text input by the user. Thus, by selecting icon **2808** (FIG. **28A**), the user may then easily respond to a caller using the same number involved in the previous call (e.g., **2816**), another number associated with the same caller (e.g., **2818**), or another mode of communication besides the phone (e.g., an email to the caller's work **2820** or home **2822** email address).

In some embodiments, UI **2800D** provides one or more options for a user to make use of a phone number in a recent call that is not associated with an entry in the user's contact list. In some embodiments, in response to a tap or other predefined user gesture, the device may: call the phone number (e.g., if the gesture is applied to icon **2824**); initiate creation of a text message or other instant message to the phone number (e.g., if the gesture is applied to icon **2825**); create a new contact with the phone number (e.g., if the gesture is applied to icon **2826**); or add the phone number to an existing contact (e.g., if the gesture is applied to icon **2828**).

In some embodiments, in response to detecting a gesture on the clear icon **2832** (e.g., a single finger tap on the icon **2832**), one or more recent calls selected by the user are deleted from the list of recent calls.

Additional description of missed call management can be found in U.S. Provisional Patent Application No. 60/883,782, "Telephone Call Management For A Portable Multifunction Device," filed Jan. 6, 2007, and U.S. patent application Ser. No. 11/769,694, "Missed Telephone Call Management for a

48

Portable Multifunction Device," filed Jun. 27, 2007, the contents of which are hereby incorporated by reference in their entirety.

FIG. **29** illustrates an exemplary dial pad interface for calling in accordance with some embodiments. In response to the user activating the number keys in dial pad **2902** (e.g., by finger taps on the number icons), the touch pad displays the selected digits **2904**. In some embodiments, the phone module automatically adds the parentheses and dashes to the selected digits to make the number easier to read. In response to the user activating the call icon **2906**, the phone module dials or transmits the selected digits. In response to the user activating the create contact icon **2908**, numbers entered with the touchpad may be used in a new contact or added to an existing contact.

In some embodiments, the device performs location-based dialing, which simplifies dialing when the user is located outside his/her home country and/or is trying to dial a destination number outside his/her home country.

Additional description of location-based dialing can be found in U.S. Provisional Patent Application No. 60/883,800, "Method, Device, And Graphical User Interface For Location-Based Dialing," filed Jan. 7, 2007, and U.S. patent application Ser. No. 11/769,692, "Method, Device, and Graphical User Interface for Location-Based Dialing," filed Jun. 27, 2007, the contents of which are hereby incorporated by reference in their entirety.

FIGS. **30A-30R** illustrate exemplary user interfaces displayed during a call in accordance with some embodiments. In some embodiments, a UI indicates that a call is being attempted **3002** (UI **3000A**, FIG. **30A**) and then indicates the connection time **3004** after the connection is made (UI **3000B**, FIG. **30B**).

In some embodiments, in response to a tap or other predefined user gesture, the device may: mute the call (e.g., if the gesture is applied to icon **3006**); place the call on hold (e.g., if the gesture is applied to icon **3008**); swap between two calls, placing one call on hold to continue another call (e.g., if the gesture is applied to icon **3009** in FIG. **30E**); place the call on a speaker (e.g., if the gesture is applied to icon **3010**); add a call (e.g., if the gesture is applied to icon **3018**); display a numeric keypad for number entry (e.g., if the gesture is applied to icon **3016**, UI **3000N** in FIG. **30N** is displayed); display the user's contact list (e.g., if the gesture is applied to icon **3020**); or end the call (e.g., if the gesture is applied to icon **3014**).

In some embodiments, if the device receives an incoming call while the user is on another call (e.g., with someone at (650) 132-2234 in FIG. **30B**), then an incoming call UI is displayed, such as UI **3000C** (FIG. **30C**) for a known caller (e.g., Arlene Brown **3024**, an entry in the user's contact list) or UI **3000K** (FIG. **30K**) for an unknown caller. In some embodiments, the incoming call UI includes icons which, when activated by a user tap or other gesture, cause the device to: (1) terminate the incoming call or send the caller to voice mail (e.g., ignore icon **3026**); (2) place the current call on hold and answer the incoming call (e.g., hold+answer icon **3028**); and/or (3) end the current call and answer the incoming call (e.g., end+answer icon **3030**).

In this example, in response to activation of the end+answer icon **3030** (e.g., by a finger tap on the icon), the call with (650) 132-2234 is ended, the call from Arlene Bascom is answered, and phone call UI **3000D** (FIG. **30D**) is displayed, which includes information **3031** identifying the caller (Arlene Bascom).

In this example, in response to activation of the hold+answer icon **3028** (e.g., by a finger tap on the icon), the call

with (650) 132-2234 is put on hold, the call from Arlene Bascom is answered, and phone call UI **3000E** (FIG. **30E**) is displayed, which includes information **3034** identifying the caller (Arlene Bascom) and information **3032** indicating that the other call is suspended. In some embodiments, in response to a user gesture on the information **3032** indicating that the other call is on hold (e.g., a finger tap **3036**) or in response to a user gesture on the swap icon **3009**, the active call is suspended, the suspended call is made active, and phone call UI **3000F** is displayed, which includes information **3033** and **3035** indicating the status of the two calls.

In some embodiments, if the merge icon **3038** (FIG. **30E** or **30F**) is activated (e.g., by a finger tap **3040** on the icon), the active call and the call on hold are merged into a conference call and a conference call UI is displayed (e.g., UI **3000G**, FIG. **30G**). The conference call UI includes information **3042** about the conference call and a conference call management icon **3044**.

In some embodiments, in response to activation of the conference call management icon **3044** (e.g., by a finger tap **3046** on the icon), a conference call management UI is displayed (e.g., UI **3000H**, FIG. **30H**), which includes an end call icon **3050** and a private call icon **3056** for each entry in the management UI. In some embodiments, in response to activation of the end call icon **3050** (e.g., by a finger tap **3052** on the icon), a confirmation icon is displayed (e.g., end call icon **3062**, FIG. **30I**) to prevent accidental deletion of a party to the conference call.

In some embodiments, in response to activation of the private call icon **3056** (e.g., by a finger tap **3058** on the icon), the conference call is suspended and a phone call UI is displayed (e.g., UI **3000J**, FIG. **30J**), which includes information **3033** about the private call and information **3035** about the suspended conference call. In this example, because only one other party in the conference call is on hold (Arlene Bascom in this example), the information **3035** about the suspended conference call is just information about the one party on hold. In some embodiments, if more than one party in the conference call is put on hold, then the information **3035** about the suspended conference call may be less specific, such as "conference on hold" or the like (e.g., information **3068** in UI **3000M**, FIG. **30M**).

If an incoming call is not from a caller known to the user (e.g. the phone number is not in the user's contact list), then an incoming call UI such as UI **3000K** (FIG. **30K**) is displayed, rather than an incoming call UI such as UI **3000C** (FIG. **30C**) with the caller's name **3024** and/or associated image **3022**.

In some embodiments, in response to activation of the add call icon **3018** (e.g., by a finger tap on the icon in FIG. **30B**, **30D**, or **30G**), the user's contact list is displayed (UI **3000O**, FIG. **30O**), which typically includes a plurality of entries that correspond to a plurality of third parties. In some embodiments, in response to activation of an entry of a third party in the contact list (e.g., by a finger tap on the entry), an outgoing phone call is initiated to the third party if there is only one phone number associated with the entry. If there is more than one phone number associated with the entry, these numbers are displayed (e.g., UI **3000P**, FIG. **30P** displays two phone numbers associated with one entry for Bruce Walker). In response to user selection of one of these numbers (e.g., by a finger tap on the desired number for the third party), an outgoing phone call is initiated. In some embodiments, in response to activation of an entry of a third party in the contact list (e.g., by a finger tap on the entry), the information for the corresponding entry is displayed independent of the number of phone numbers associated with the entry and, in response

to user selection of a phone number in the entry, an outgoing phone call is initiated to the third party.

In some embodiments, in response to activation of the keypad icon **3016** (e.g., by a finger tap on the icon), a keypad UI for entering digits during a call is displayed (e.g., UI **3000N**, FIG. **30N**), which includes a dial pad **2902**, a hide keypad icon **3074**, and an end call icon **3071**. In some embodiments, in response to activation of icon **3074** (e.g., by a finger tap or other gesture on the icon), the UI that was being displayed immediately prior to the display of the keypad UI is displayed again.

Creating a Conference Call from Two Existing Calls

In some embodiments, the device **100** displays a phone call user interface (e.g., UI **3000E**, FIG. **30E**) on the touch screen display. The phone call user interface includes a first informational item associated with an active phone call between a user of the device and a first party (e.g., **3034**), a second informational item associated with a suspended phone call between the user and a second party (e.g., **3032**), and a merge call icon (e.g., **3038**).

Upon detecting a user selection of the merge call icon, (1) the active phone call and the suspended phone call are merged into a conference call between the user, the first party, and the second party; and (2) the phone call user interface is replaced with a conference call user interface (e.g., UI **3000G**, FIG. **30G**). The conference call user interface includes: a third informational item associated with the conference call (e.g., **3042**) in replacement of the first and second informational items, and a conference call management icon (e.g., **3044**).

Managing a Conference Call

In some embodiments, upon detecting a user selection (e.g., gesture **3046**) of the conference call management icon **3044**, the conference call user interface (e.g., UI **3000G**) is replaced with a conference call management user interface (e.g., UI **3000H**, FIG. **30H**). The conference call management user interface includes a first management entry corresponding to the first party (e.g., **3060**) and a second management entry corresponding to the second party (e.g., **3054**), each management entry including an end call icon (e.g., **3050**) and a private call icon (e.g., **3056**), and a back (or previous screen) icon (e.g., **3048**). If additional parties were also participating in the conference call (e.g., by a user adding caller(s) and then merging the added caller(s)), then management entries for these additional parties would also appear in the conference call management user interface (e.g., UI **3000H**, FIG. **30H**).

In some embodiments, upon detecting a user selection (e.g., gesture **3052**) of the end call icon in the first management entry, a confirmation icon (e.g., **3062**, FIG. **3000I**) is displayed on the touch screen display. Upon detecting a user selection of the confirmation icon, the first party is excluded from the conference call; and the first management entry is removed from the touch screen display.

In some embodiments, upon detecting a user selection (e.g., gesture **3058**) of the private call icon in the second management entry, the conference call is suspended and the conference call management user interface is replaced with the phone call user interface (e.g., UI **3000J**, FIG. **30J**). The phone call user interface includes a fourth informational item associated with a suspended phone call between the user and the first party (e.g., **3035**), a fifth informational item associated with an active phone call between the user and the second party (e.g., **3033**), and the merge call icon (e.g., **3038**).

In some embodiments, the conference call is resumed upon detecting a second user selection of the merge call icon; and the phone call user interface (e.g., UI **3000J**, FIG. **30J**),

US 7,479,949 B2

51

including the fourth and fifth informational items, is replaced with the conference call user interface (e.g., UI 3000G, FIG. 30G).

Receive an Incoming Call During a Conference Call

In some embodiments, upon detecting an incoming phone call from a third party, the conference call user interface or the conference call management user interface (i.e., whichever interface is being displayed when the incoming call is detected) is replaced with an incoming phone call user interface (e.g., UI 3000C, FIG. 30C for a known caller or UI 3000K, FIG. 30K for an unknown caller). The incoming phone call user interface includes an ignore incoming phone call icon (e.g., 3026), a suspend current phone call and answer incoming phone call icon (e.g., 3028), and an end current phone call and answer incoming phone call icon (e.g., 3030).

In some embodiments, upon detecting a user selection of the ignore incoming phone call icon (e.g., 3026), the incoming phone call from the third party is terminated or sent to voice mail; the conference call with the first and second parties is continued; and the incoming phone call user interface is replaced with the conference call user interface or the conference call management user interface (i.e., whichever interface was being displayed when the incoming call was detected).

In some embodiments, upon detecting a user selection of the end current phone call and answer incoming phone call icon (e.g., 3030), the conference call with the first and second parties is terminated; a phone call between the user and the third party is activated; and the incoming phone call user interface is replaced with a phone call user interface (e.g., UI 3000L, FIG. 30L). The phone call user interface includes a sixth informational item associated with the phone call between the user and the third party (e.g., 3066).

In some embodiments, upon detecting a user selection of the suspend current phone call and answer incoming phone call icon (e.g., 3028), the conference call with the first and second parties is suspended; a phone call between the user and the third party is activated; and the incoming phone call user interface is replaced with a phone call user interface (e.g., UI 3000M, FIG. 30M). The phone call user interface includes a sixth informational item associated with the phone call between the user and the third party (e.g., 3066), a seventh informational item associated with the suspended conference call between the user and the first and second parties (e.g., 3068), and a merge call icon (e.g., 3038).

In some embodiments, upon detecting a user selection of the suspend current phone call and answer incoming phone call icon, a phone call between the user and the third party is activated and the incoming phone call user interface is replaced with a phone call user interface (e.g., UI 3000M, FIG. 30M). The phone call user interface includes a sixth informational item associated with the phone call between the user and the third party (e.g., 3066), a seventh informational item associated with the suspended conference call between the user and the first and second parties (e.g., 3068), and a merge call icon (e.g., 3038).

Adding a Caller During a Conference Call

In some embodiments, the conference call user interface includes an add caller icon (e.g., 3018, FIG. 30G). Upon detecting a user selection of the add caller icon, the conference call with the first and second parties is suspended and a contact list is displayed (e.g., UI 3000O, FIG. 30O).

An outgoing phone call is initiated to a third party using a phone number from an entry in the contact list or a phone number input by a user (e.g., using dial pad 2902, FIG. 29).

52

Upon detecting an acceptance of the outgoing phone call, a phone call user interface is displayed (e.g., UI 3000M, FIG. 30M, where (987) 654-3210 now corresponds to an outbound call rather than an inbound call) that includes an eighth informational item associated with the suspended conference call (e.g., 3068), a ninth informational item associated with the outgoing phone call between the user and the third party (e.g., 3066), and a merge call icon (e.g., 3038).

Upon detecting a user selection of the merge call icon, (1) the outgoing phone call between the user and the third party and the suspended conference call are merged into a conference call between the user, the first party, the second party, and the third party; and (2) the phone call user interface is replaced with a conference call user interface (e.g., UI 3000G, FIG. 30G).

Additional description of conference calling can be found in U.S. Provisional Patent Application No. 60/947,133, "Portable Multifunction Device, Method, and Graphical User Interface for Conference Calling," filed Jun. 29, 2007, and U.S. patent application Ser. No. 11/960,673, "Portable Multifunction Device, Method, and Graphical User Interface for Conference Calling," filed Dec. 19, 2007, the content of which is hereby incorporated by reference in its entirety.

In some embodiments, the multifunction device 100 permits a user to conduct a phone call while simultaneously using other functions of the device in an intuitive manner. In some embodiments, in response to activation of a menu icon or button (e.g., home 204, FIG. 4A) while a user is on a phone call, a menu of application icons is displayed on the touch screen. In some embodiments, an icon for the phone application (e.g., 3076, FIG. 30Q) is highlighted (or otherwise changed in appearance as compared to when the phone application is not in use) to indicate that the phone application is in use. In response to activation of an application icon in the menu other than the phone application icon (e.g., by a finger tap or other gesture on the application icon), the corresponding application is displayed along with a switch application icon (e.g., the "press here to return to call" icon 3078, FIG. 30R). The user may operate the other non-phone application in essentially the same manner as when the phone application is not simultaneously being used. However, in response to activation of the switch application icon (e.g., by a finger tap on icon 3078 in FIG. 30R), the device displays the phone application.

Additional description of application switching can be found in U.S. Provisional Patent Application No. 60/883,809, "Portable Electronic Device Supporting Application Switching," filed Jan. 7, 2007, and U.S. patent application Ser. No. 11/969,908, "Portable Electronic Device Supporting Application Switching," filed Jan. 6, 2008, the content of which is hereby incorporated by reference in its entirety.

FIGS. 31A and 31B illustrate an exemplary user interface displayed during an incoming call in accordance with some embodiments.

In some embodiments, if the incoming call is from a phone number that is associated with a person or other entry in the user's contact list, then the touch screen may display: the name 3102 of the person or entry; a graphic 3104 associated with the person or entry; a Decline icon 3106 that when activated (e.g., by a finger tap on the icon) causes the phone module to decline the call and/or initiate voicemail for the call; and an answer icon 3108 that when activated (e.g., by a finger tap on the icon) causes the phone module to answer the call (e.g., UI 3100A, FIG. 31A).

In some embodiments, if the incoming call is from a phone number that is not associated with a person or other entry in the user's contact list, then the touch screen may display: the

phone number of the other party **3110**; a Decline icon **3106** that when activated (e.g., by a finger tap on the icon) causes the phone module to decline the call and/or initiate voicemail for the call; and an answer icon **3108** that when activated (e.g., by a finger tap on the icon) causes the phone module to answer the call (e.g., UI **310B**, FIG. **31B**).

In some embodiments, the device pauses some other applications (e.g., the music player **146**, video player, and/or slide show) when there is an incoming call; displays UI **3100A** or UI **3100B** prior to the call being answered; displays user interfaces like UI **3000B** (FIG. **30B**) during the call; and terminates the pause on the other applications if the incoming call is declined or the call ends. In some embodiments, there is a smooth transition into and out of a pause (e.g., a smooth lowering and raising of the sound volume for the music player).

Additional description of user interfaces for handling incoming calls can be found in U.S. Provisional Patent Application No. 60/883,783, "Incoming Telephone Call Management For A Portable Multifunction Device," filed Jan. 6, 2007, and U.S. patent application Ser. No. 11/769,695, "Incoming Telephone Call Management For A Portable Multifunction Device," filed Jun. 27, 2007, the contents of which are hereby incorporated by reference in their entirety.

FIGS. **32A-32H** illustrate exemplary user interfaces for voicemail in accordance with some embodiments. In some embodiments, user interfaces **3200A-3200D** include the following elements, or a subset or superset thereof:

- 402**, **404**, and **406**, as described above;
- backup icon **3202** that when activated (e.g., by a finger tap on the icon) initiates a process that backs up and replays the preceding few seconds of the voicemail message;
- Progress bar **3204** that indicates what fraction of a voicemail message has been played and that may be used to help scroll through the message in response to a user gesture **3206**;
- Speed up icon **3208** that when activated (e.g., by a finger tap on the icon) initiates a process that speeds up playback of the voicemail message, which may also adjust the sound frequency or pitch of the fast playback so that the words, although spoken quickly, are still easy to understand;
- Names **3210** of the people (associated with incoming phone numbers via the user's contact list) who have left voicemail messages (e.g., Aaron Jones **3210-1**) or the phone number if the person's name is not available (e.g., 408-246-8101 **3210-2**);
- Date **3212** and/or time of the voicemail;
- Additional information icon **3214** that when activated (e.g., by a finger tap on the icon) initiates transition to the corresponding contact list entry (e.g., UI **2800C**, FIG. **28C**) or to a UI for unknown phone numbers (e.g., UI **2800D**, FIG. **28D**);
- Speaker icon **3216** that when activated (e.g., by a finger tap on the icon) initiates playback of the voicemail through a speaker;
- Options icon **3218** that when activated (e.g., by a finger tap on the icon) initiates display of a menu of additional voicemail options;
- Pause icon **3220** that when activated (e.g., by a finger tap on the icon) initiates pausing of the voicemail, which may be displayed apart from individual messages (FIG. **32A**) or adjacent to a selected message (FIG. **32C**);
- Delete symbol icon **3222** that when activated (e.g., by a finger tap on the icon) initiates display of a UI to confirm that the user wants to delete the corresponding voicemail (e.g. UI **3200B**, FIG. **32B** or UI **3200D**, FIG. **32D**).

Cancel icon **3226** that when activated (e.g., by a finger tap on the icon) changes the display from UI **3200B** to UI **3200A** (or from UI **3200D** to UI **3200C**) without deleting the corresponding voicemail;

Confirm delete icon **3228** that when activated (e.g., by a finger tap on the icon) deletes the corresponding voicemail and changes the display from UI **3200B** to UI **3200A** (or from UI **3200D** to UI **3200C**);

Play icon **3230** that when activated (e.g., by a finger tap on the icon) initiates or continues playback of the voicemail, which may be displayed apart from individual messages (FIG. **32B**) or adjacent to a selected message (FIG. **32C**);

Not heard icon **3232** that indicates that the corresponding voicemail has not been heard;

Downloading icon **3234** that indicates that the corresponding voicemail is being downloaded to the device **100**; and

Call icon **3240** that when activated (e.g., by a finger tap on the icon) initiates a call to the phone number associated with the selected voicemail.

If the list of voicemail messages fills more than the screen area, the user may scroll through the list using vertically upward and/or vertically downward gestures **3224** on the touch screen.

In some embodiments, a vertical bar **3260** (FIG. **32C**), analogous to the vertical bars described above, is displayed on top of the list of voicemails that helps a user understand what portion of the list is being displayed.

In some embodiments, in response to a user tap or other predefined gesture in the row corresponding to a particular voicemail (but other than a tap or gesture on icon **3214**), the phone module initiates playback of the corresponding voicemail. Thus, there is random access to the voicemails and the voicemails may be heard in any order.

In some embodiments, in response to a user gesture, the playback position in the voicemail can be modified. For example, in response to the user's finger touching **3206** at or near the end of the progress bar and then sliding along the progress bar, the playback position may be altered to correspond to the position of the user's finger along the progress bar. This user gesture on the progress bar (which is analogous to the gesture **2316** in UI **2300B** for the video player, which also creates an interactive progress bar) makes it easy for a user to skip to and/or replay portions of interest in the voicemail message.

In some embodiments, user interfaces **3200E-3200H** for setting up voicemail include the following elements, or a subset or superset thereof:

- 402**, **404**, **406**, and **2902** as described above;
- instructions **3242** that assist the user in the setup process;
- initiation icon **3244** that when activated (e.g., by a finger tap on the icon) initiates the set up process;
- password set up icon **3246** that when activated (e.g., by a finger tap on the icon) displays a key pad **2902** for entering a voicemail password in input field **3249**;
- greeting set up icon **3248** that when activated (e.g., by a finger tap on the icon) displays icons (e.g., **3250**, **3252**, **3254**, and **3256**) for creating a voice mail greeting;
- record icon **3250** that when activated (e.g., by a finger tap on the icon) initiates recording of the voicemail greeting;
- play icon **3252** that when activated (e.g., by a finger tap on the icon) initiates playback of the voicemail greeting;
- speaker icon **3254** that when activated (e.g., by a finger tap on the icon) initiates playback of the voicemail greeting through a speaker;

reset icon **3256** that when activated (e.g., by a finger tap on the icon) initiates resetting of the voicemail greeting (e.g., to a default system greeting, rather than a user-created greeting); and

stop icon **3258** that when activated (e.g., by a finger tap on the icon) initiates stopping the playback of the voicemail greeting.

User interfaces **3200E-3200H** provide visual cues that make it easy for a user to setup voicemail.

In some embodiments, a portable multifunction device (e.g., device **100**) displays a voicemail setup user interface on a touch screen display (e.g., display **112**). The user interface includes a password setup icon (e.g., icon **3246**, FIG. **32F**) and a greeting setup icon (e.g., icon **3248**, FIG. **32F**).

A user selection of the password setup icon is detected. Upon detecting user selection of the password setup icon **3246**, an input field (e.g., **3249**) and a key pad (e.g., **2902**) are displayed. In some embodiments, one or more copies of a predefined character are added in the input field in response to a finger contact with the key pad.

A user selection of the greeting setup icon is detected. Upon detecting user selection of the greeting setup icon, a record icon (e.g., icon **3250**, FIG. **32G**), a play icon (e.g., icon **3252**), and a reset icon (e.g., icon **3256**) are displayed.

In some embodiments, in response to detection of a selection of the record icon, recording of an audio stream is started and the play icon is replaced with a stop icon (e.g., icon **3258**, FIG. **32H**). In response to detection of a selection of the stop icon, recording of the audio stream is stopped and the stop icon is replaced with the play icon. In some embodiments, in response to detection of a selection of the play icon, the recorded audio stream is played and the play icon is replaced with the stop icon. In response to detection of a selection of the stop icon, playing of the recorded audio stream is stopped and the stop icon is replaced with the play icon.

In some embodiments, in response to detection of a selection of the reset icon, a default message is assigned. In response to detection of a selection of the play icon, the default message is played and the play icon is replaced with the stop icon. In response to detection of a selection of the stop icon, playing of the default message is stopped and the stop icon is replaced with the play icon. In some embodiments, the default message includes a telephone number associated with the portable multifunction device. In some embodiments, the default message comprises a synthesized audio stream.

Additional description of the voicemail system can be found in U.S. Provisional Patent Application No. 60/883,799, "Voicemail Manager For Portable Multifunction Device," filed Jan. 7, 2007; U.S. patent application Ser. No. 11/770,720, "Voicemail Manager for Portable Multifunction Device," filed Jun. 28, 2007; and 60/947,348, "Voicemail Set-Up on a Portable Multifunction Device," filed Jun. 29, 2007; and U.S. patent application Ser. No. 11/961,716, "Voicemail Set-Up on a Portable Multifunction Device," filed Dec. 20, 2007, the contents of which are hereby incorporated by reference in their entirety.

Email

FIG. **33** illustrates an exemplary user interface for organizing and managing email in accordance with some embodiments. In some embodiments, user interface **3300** includes the following elements, or a subset or superset thereof:

402, **404**, and **406**, as described above;

a set of mailboxes, such as inbox **3302**, which may be organized in rows with a selection icon **3306** for each row;

an unread messages icon **3304** that indicates the number of unread messages;

a settings icon **3308** that when activated (e.g., by a finger tap on the icon) initiates display of a UI to input mailbox settings (e.g. UI **3600**, FIG. **36**); and

a create email icon **3310** that when activated (e.g., by a finger tap on the icon) initiates display of a UI for creating a new email message (e.g. UI **3400**, FIG. **34**).

If the set of mailboxes fills more than the screen area, the user may scroll through the mailboxes using vertically upward and/or vertically downward gestures **3312** on the touch screen.

In some embodiments, a vertical bar, analogous to the vertical bars described above, is displayed on top of the list of mailboxes that helps a user understand what portion of the list is being displayed.

FIGS. **34A-34C** illustrate an exemplary user interface for creating emails in accordance with some embodiments.

In response to the user activating create email icon **3310** (FIG. **33**), the device displays UI **3400A**.

In some embodiments, if the user makes a tap or other predefined gesture on the subject line **3408** or in the body of the email **3412** (FIG. **34A**), a letter keyboard **616** appears and the user may input the subject and/or body text (FIG. **34C**). In some embodiments, to enter the email address, the user makes a tap or other predefined gesture on the To: line **3406** of the email; the user's contact list appears (e.g., FIG. **18J**); the user makes a tap or other predefined gesture on the desired recipient/contact; and the device places the corresponding email address in the email message (FIG. **34C**). If others need to be copied on the email, the user makes a tap or other predefined gesture on the CC: line **3407** of the email; the user's contact list appears (FIG. **18J**); the user makes a tap or other predefined gesture on the desired recipient/contact (e.g., tapping on Janet Walker in the contact list); and the device places the corresponding email address in the email message (FIG. **34C**).

In some embodiments, to enter the email address, the user makes a tap or other predefined gesture on the To: line **3406** of the email (FIG. **34A**). Addrecipient icon **3422** appears, which when activated (e.g., by a finger tap on the icon **3422**) initiates the display of a scrollable list of contacts (e.g., **3426**, FIG. **34B**) that match the input, if any, in the To: field. For example, if the letter "B" is input, then contacts with either a first name or last name beginning with "B" are shown. If the letters "Br" are input in the To: field, then the list of contacts is narrowed to contacts with either a first name or last name beginning with "Br", and so on until one of the displayed contacts is selected (e.g., by a tap on a contact in the list **3426**). If others need to be copied on the email, the user makes a tap or other predefined gesture on the CC: line **3407** of the email and follows an analogous procedure to that used for inputting addresses in the To: field. In some embodiments, the scrollable list **3426** also includes names and/or email addresses that are in emails previously sent or received by the user, even if those names and/or email addresses are not in the user's contact list. In some embodiments, the order in which email addresses are displayed in the scrollable list **3426** is based on the amount of prior email messaging with each email address. In other words, for the names and/or email addresses that match the letters input by the user, the names and/or email addresses that have had more recent and/or more frequent email exchanges with the user are placed ahead of the names and/or email addresses that have had less recent and/or less frequent email exchanges with the user. In some embodiments, the order in which email addresses are displayed in the scrollable list **3426** is based on the amount of prior commu-

US 7,479,949 B2

57

nications with a potential addressee for a plurality of communications modalities. For example, a potential addressee that is frequently in phone and/or instant message conversations with the user (in addition to email exchanges with the user) may be placed ahead of other potential addressees.

In some embodiments, a user can scroll through the list **3426** by applying a vertical swipe gesture **3428** to the area displaying the list **3426**. In some embodiments, a vertically downward gesture scrolls the list downward and a vertically upward gesture scrolls the list upward,

In some embodiments, a vertical bar **3430** is displayed temporarily after an object is detected on or near the touch screen display (e.g., a finger touch is detected anywhere on the list **3426**). In some embodiments, the vertical bar **3430** has a vertical position on top of the displayed portion of the list that corresponds to the vertical position in the list of the displayed portion of the list. In some embodiments, the vertical bar **3430** has a vertical length that corresponds to the portion of the list being displayed.

In some embodiments, the user may also enter the email address using one or more keyboards (e.g., **616** and **624**, not shown).

The device sends the email message in response to the user activating the send icon **3404** (FIG. **34C**) (e.g., by a finger tap on the icon). Alternatively, if the user activates the cancel icon **3402**, the device may display a save draft icon (e.g., **1810**, FIG. **18I**) and a don't save (or delete message) icon (e.g., **1812**, FIG. **18I**). The device saves the draft if the user activates the save draft icon **1810**, e.g., in a drafts folder in email client **140** (FIG. **33**). The device deletes the draft if the user activates the don't save icon **1812**.

In some embodiments, in response to the user activating the attach icon **3410** (e.g., by a finger tap on the icon), the touch screen displays a UI for adding attachments (not shown).

FIGS. **35A-35O** illustrate exemplary user interfaces for displaying and managing an inbox in accordance with some embodiments. Analogous user interfaces may be used to display and manage the other mailboxes (e.g., drafts, sent, trash, personal, and/or work in UI **3300**). In some embodiments, user interfaces **3500A-3500I** include the following elements, or a subset or superset thereof:

402, 404, 406, and 3310, as described above;

mailboxes icon **3502** that when activated (e.g., by a finger tap on the icon) initiates the display of mailbox UI **3300** (FIG. **33**);

unread messages icon **3504** that displays the number of unread messages in the inbox;

names **3506** of the senders of the email messages;

subject lines **3508** for the email messages;

dates **3510** of the email messages;

unread message icons **3512** that indicate messages that have not been opened;

preview pane separator **3518** that separates the list of messages from a preview of a selected message in the list;

settings icon **3520** that when activated (e.g., by a finger tap on the icon) initiates the display of settings UI **3600** (FIG. **36**);

move message icon **3522** that when activated (e.g., by a finger tap on the icon) initiates the display of move message UI **3800A** (FIG. **38A**);

Delete symbol icon **3524** that when activated (e.g., by a finger tap on the icon) initiates display of a UI to confirm that the user wants to delete the selected email (e.g. UI **3500E**, FIG. **35E**);

Reply/Forward icon **3526** that when activated (e.g., by a finger tap on the icon) initiates display of a UI to select

58

how to reply or forward the selected email (e.g. UI **3500F**, FIG. **35F** or UI **3500I**, FIG. **35I**);

Preview pane **3528** that displays a portion of the selected email message;

Details icon **3530** that when activated (e.g., by a finger tap on the icon) initiates display of email addressing details (e.g., **3534-1**, FIG. **35C** or **3534-2** FIG. **35L**);

Hide details icon **3531** (FIG. **35L**) that when activated (e.g., by a finger tap on the icon) ceases display of email addressing details (e.g., **3534-2** FIG. **35K**);

Cancel icon **3540** (FIG. **35E**) that when activated (e.g., by a finger tap on the icon) returns the device to the previous user interface (e.g. UI **3500D**);

Confirm delete icon **3542** (FIG. **35E**) that when activated (e.g., by a finger tap on the icon) deletes the selected email;

Reply icon **3544** (FIG. **35F**) that when activated (e.g., by a finger tap on the icon) initiates creation of an email replying to the sender;

Reply All icon **3546** (FIG. **35F**) that when activated (e.g., by a finger tap on the icon) initiates creation of an email replying to the sender and the other parties included in the selected email (e.g., by cc:);

Forward icon **3548** (FIG. **35F**) that when activated (e.g., by a finger tap on the icon) initiates creation of an email to be forwarded;

Show preview pane icon **3550** (FIG. **35G**) that when activated (e.g., by a finger tap on the icon) initiates display of preview pane **3528**;

Don't show preview pane icon **3552** (FIG. **35G**) that when activated (e.g., by a finger tap on the icon) stops display of preview pane **3528**;

Vertical bar **3554** (FIG. **35H**) for the list of email messages that helps a user understand what portion of the list of email messages is being displayed;

Vertical bar **3556** (FIG. **35H**) for the email message in the preview pane that helps a user understand what portion of the message is being displayed;

Horizontal bar **3558** (FIG. **35H**) for the email message in the preview pane that helps a user understand what portion of the message is being displayed;

Refresh mailbox icon **3560** (FIG. **35H**) that when activated (e.g., by a finger tap on the icon) initiates downloading of new email messages, if any, from a remote server;

Edit icon **3562** (FIG. **35J**) that when activated (e.g., by a finger tap on the icon) initiates display of a user interface for deleting emails (e.g., as described in U.S. Provisional Patent Application Nos. 60/883,814, "Deletion Gestures On A Portable Multifunction Device," filed Jan. 7, 2007, and 60/936,755, "Deletion Gestures On A Portable Multifunction Device," filed Jun. 22, 2007, and U.S. patent application Ser. No. 11/850,642, "Deletion Gestures On A Portable Multifunction Device," filed Sep. 5, 2007, the contents of which are hereby incorporated by reference in their entirety);

text body lines **3564** (FIG. **35J**) for the email messages;

Previous email message icon **3566** (FIG. **35K**) that when activated (e.g., by a finger tap on the icon) initiates display of the previous email message in the corresponding mailbox;

Next email message icon **3568** (FIG. **35K**) that when activated (e.g., by a finger tap on the icon) initiates display of the next email message in the corresponding mailbox;

Attachment icon **3570** (FIG. **35K**) that when activated (e.g., by a finger tap on the icon) initiates display of the corresponding attachment **3572**, either as part of the email message (e.g., activating **3570-1**, FIG. **35K** ini-

tiates display of **3572-1**, FIG. **35L**) or apart from the email message (e.g., activating **3570-3**, FIG. **35M** initiates display of **3572-3**, FIG. **35N**);

Attachment **3572** (FIG. **35K**) (e.g., a digital image, a PDF file, a word processing document, a presentation document, a spreadsheet, or other electronic document); and Return to email message icon **3574** (FIG. **35N**) that when activated (e.g., by a finger tap on the icon) initiates display of the email message that included the attachment.

If the set of emails fill more than the screen area (or more than the screen area above the preview pane), the user may scroll through the emails using vertically upward and/or vertically downward gestures **3514** on the touch screen.

In some embodiments, vertical bar **3554** is displayed temporarily after an object is detected on or near the touch screen display (e.g., a finger touch is detected anywhere on the list of email messages). In some embodiments, the vertical bar **3554** has a vertical position on top of the displayed portion of the email list that corresponds to the vertical position in the list of the displayed portion of the list. In some embodiments, the vertical bar **3554** has a vertical length that corresponds to the portion of the email list being displayed. For example, in FIG. **35H**, the vertical position of the vertical bar **3554** indicates that the middle of the email list is being displayed and the vertical length of the vertical bar **3554** indicates that roughly one third of the e-mail list is being displayed.

In some embodiments, the email subjects **3508** are not displayed if the preview pane **3528** is used. In some embodiments, the position of the preview pane separator can be adjusted by the user making contact **3516** at or near the preview pane separator and moving the separator to the desired location by dragging the finger contact **3538**. In some embodiments, arrows **3539** or other graphics appear during the positioning of the preview pane separator (e.g., UI **3500D**, FIG. **35D**) to help guide the user.

In some embodiments, text body lines **3564** for the email messages are displayed (e.g., UI **3500J**, FIG. **35J**). In some embodiments, a user may choose the amount of each email message (e.g., the sender name **3506**, subject **3508**, and/or number of text body lines) that is displayed in the list of email messages (e.g., as part of settings **412**). In some embodiments, a user can select the number of text body lines **3564** that are displayed for each email message in the list of email messages (e.g., as part of settings **412**). In some embodiments, the displayed text from the body of the email message is text that has been extracted by the email client **140** from the HTML version of the selected message. Thus, if the email message body has both plain text and HTML portions, the portion used for generating the text body lines to be displayed is the HTML portion.

In some embodiments, when an attachment icon **3570** is activated (e.g., by a finger tap on the icon) display of the corresponding attachment **3572** is initiated. In some embodiments, the attachment is shown as part of the email message (e.g., activating **3570-1**, FIG. **35K** initiates display of **3572-1**, FIG. **35L**). In some embodiments, the attachment is shown apart from the email message (e.g., activating **3570-3**, FIG. **35M** initiates display of **3572-3**, FIG. **35N**). In some embodiments, when Return to email message icon **3574** (FIG. **35N**) is activated (e.g., by a finger tap on the icon) display of the email message that included the attachment is initiated.

In some embodiments, in response to a tap or other predefined gesture by the user in a row containing information (e.g., **3506**, **3510**, and/or **3508**) about a particular email message, some or all of the text in the row is highlighted (e.g., by coloring, shading, or bolding) and the corresponding message is displayed in the preview pane area. In some embodiments, in response to a tap or other predefined gesture by the user in

a row containing information (e.g., **3506**, **3510**, and/or **3508**) about a particular email message, the email message is displayed on the full screen if the preview pane is not being used.

In some embodiments, if the selected email fills more than the preview pane area, the user may scroll through the email using two-dimensional gestures **3532** (FIG. **35B**) in the preview pane with vertical and/or horizontal movement of the email on the touch screen.

In some embodiments, vertical bar **3556** is displayed temporarily after an object is detected on or near the touch screen display (e.g., a finger touch is detected anywhere on the email message in the preview pane **3528**). In some embodiments, the vertical bar **3556** has a vertical position on top of the displayed portion of the email message that corresponds to the vertical position in the email of the displayed portion of the email. In some embodiments, the vertical bar **3556** has a vertical length that corresponds to the portion of the email being displayed. For example, in FIG. **35H**, the vertical position of the vertical bar **3556** indicates that the top of the email is being displayed and the vertical length of the vertical bar **3556** indicates that a portion from the top quarter of the email is being displayed.

In some embodiments, horizontal bar **3558** is displayed temporarily after an object is detected on or near the touch screen display (e.g., a finger touch is detected anywhere on the email message in the preview pane **3528**). In some embodiments, the horizontal bar **3558** has a horizontal position on top of the displayed portion of the email that corresponds to the horizontal position in the email of the displayed portion of the email. In some embodiments, the horizontal bar **3558** has a horizontal length that corresponds to the portion of the email being displayed. For example, in FIG. **35H**, the horizontal position of the horizontal bar **3558** indicates that a portion of the left side of the email is being displayed and the horizontal length of the horizontal bar **3558** indicates that a portion from the left half of the email is being displayed. Together, vertical bar **3556** and horizontal bar **3558** indicate that the northwest corner of the email message in the preview pane is being displayed.

In some embodiments, an email message is displayed such that only vertical scrolling is needed, in which case horizontal bar **3558** is not used.

In some embodiments, in response to user activation of an additional information icon (e.g., ">") on the detail information **3534** in FIG. **35C** (e.g., by a finger tap **3536** on the icon), the touch screen may display contact list information for the corresponding party, if available (e.g., UI **2800C**, FIG. **28C**) or a UI analogous to UI **2800D**, FIG. **28D**.

In some embodiments, in response to detecting a horizontal swipe gesture (e.g., **3576**, FIG. **35O**) on a particular email message in a the list of emails messages, a process for deleting the particular email message is initiated (e.g., as described in U.S. Provisional Patent Application Nos. 60/883,814, "Deletion Gestures On A Portable Multifunction Device," filed Jan. 7, 2007, and 60/936,755, "Deletion Gestures On A Portable Multifunction Device," filed Jun. 22, 2007, and U.S. patent application Ser. No. 11/850,642, "Deletion Gestures On A Portable Multifunction Device," filed Sep. 5, 2007, the contents of which are hereby incorporated by reference in their entirety).

FIG. **36** illustrates an exemplary user interface for setting email user preferences in accordance with some embodiments. In some embodiments, user interface **3600** includes the following elements, or a subset or superset thereof:

402, **404**, and **406**, as described above;

Done icon **3602** that when activated (e.g., by a finger tap on the icon) returns the device to the previous UI;

US 7,479,949 B2

61

Accounts **3604** for entering email account information; Message list displays **3606** for selecting whether sender **3506** and/or subject **3508** information is displayed in the emails lists; Display newest messages **3608** for selecting whether the newest messages are displayed at the top or bottom of the screen; Message display locations **3610** for selecting whether the messages are displayed in the preview pane or full screen; Preferred message format **3612** for selecting how the messages are formatted (e.g., HTML or plain text); Rules **3614** for creating rules for managing email messages (e.g., using UI **3700A**, FIG. **37A**, and UI **3700B**, FIG. **37B**); Selection icons **3616** that when activated (e.g., by a finger tap on the icon) show choices for the corresponding settings.

In some embodiments, a user may tap anywhere in the row for a particular setting to initiate display of the corresponding setting choices.

In some embodiments, the settings in FIG. **36** are incorporated into settings **412** (FIG. **4B**) and settings icon **3520** need not be displayed in the email application **140** (e.g., FIG. **35G**).

FIGS. **37A** and **37B** illustrate an exemplary user interface for creating and managing email rules in accordance with some embodiments. In some embodiments, user interface **3700A** includes the following elements, or a subset or superset thereof:

402, **404**, and **406**, as described above;

Settings icon **3702** that when activated (e.g., by a finger tap on the icon) returns the device to the settings UI **3600** (FIG. **3600**);

Rules **3704**;

Selection icons **3706** that when activated (e.g., by a finger tap on the icon) show choices for the corresponding rules.

Add icon **3708** that when activated (e.g., by a finger tap on the icon) displays a UI for creating a new rule (e.g., UI **3700B**, FIG. **37B**);

Done icon **3710** that when activated (e.g., by a finger tap on the icon) returns the device to the settings UI **3600** (FIG. **3600**);

In some embodiments, a user may tap anywhere in the row for a particular rule to initiate display of the corresponding rule (e.g., UI **3700B**, FIG. **37B**).

FIGS. **38A** and **38B** illustrate an exemplary user interface for moving email messages in accordance with some embodiments.

In response to the user activating create move message icon **3522**, the device displays UI **3800A**, with some information **3804** for the selected message displayed.

In some embodiments, if the user makes a tap **3802** or other predefined gesture on a row corresponding to a particular mailbox or other folder, the message is moved to the corresponding mailbox or folder (e.g., Work in FIG. **38A**). In some embodiments, the selected row is highlighted and an animation appears to move the message information **3804** into the selected row (as illustrated schematically in FIG. **38B**).

Additional description of an email client can be found in U.S. Provisional Patent Application No. 60/883,807, "Email Client For A Portable Multifunction Device," filed Jan. 7, 2007, and U.S. patent application Ser. No. 11/850,630, "Email Client For A Portable Multifunction Device," filed Sep. 5, 2007, the content of which is hereby incorporated by reference in its entirety.

62

Methods for efficiently fetching email messages can be found in U.S. Provisional Patent Application No. 60/947,395, "Email Fetching System and Method in a Portable Electronic Device," filed Jun. 29, 2007, and U.S. patent application Ser. No. 11/968,070, "Email Fetching System and Method in a Portable Electronic Device," filed Dec. 31, 2007, the content of which is hereby incorporated by reference in its entirety.

Methods for automatically selecting email ports and email security can be found in U.S. Provisional Patent Application No. 60/947,396, "Port Discovery and Message Delivery in a Portable Electronic Device," filed Jun. 29, 2007, and U.S. patent application Ser. No. 11/968,076, "Port Discovery and Message Delivery in a Portable Electronic Device," filed Dec. 31, 2007, the content of which is hereby incorporated by reference in its entirety.

Browser

FIGS. **39A-39M** illustrate exemplary user interfaces for a browser in accordance with some embodiments.

In some embodiments, user interfaces **3900A-3900M** include the following elements, or a subset or superset thereof:

402, **404**, and **406**, as described above;

Previous page icon **3902** that when activated (e.g., by a finger tap on the icon) initiates display of the previous web page;

Web page name **3904**;

Next page icon **3906** that when activated (e.g., by a finger tap on the icon) initiates display of the next web page;

URL (Uniform Resource Locator) entry box **3908** for inputting URLs of web pages;

Refresh icon **3910** that when activated (e.g., by a finger tap on the icon) initiates a refresh of the web page;

Web page **3912** or other structured document, which is made of blocks **3914** of text content and other graphics (e.g., images and inline multimedia);

Settings icon **3916** that when activated (e.g., by a finger tap on the icon) initiates display of a settings menu for the browser;

Bookmarks icon **3918** that when activated (e.g., by a finger tap on the icon) initiates display of a bookmarks list or menu for the browser;

Add bookmark icon **3920** that when activated (e.g., by a finger tap on the icon) initiates display of a UI for adding bookmarks (e.g., UI **3900F**, FIG. **39F**, which like other UIs and pages, can be displayed in either portrait or landscape view);

New window icon **3922** that when activated (e.g., by a finger tap on the icon) initiates display of a UI for adding new windows (e.g., web pages) to the browser (e.g., UI **3900G**, FIG. **39G**), and which may also indicate the number of windows (e.g., "4" in icon **3922**, FIG. **39A**);

Vertical bar **3962** (FIG. **39H**), analogous to the vertical bars described above, for the web page **3912** or other structured document that helps a user understand what portion of the web page **3912** or other structured document is being displayed;

Horizontal bar **3964** (FIG. **39H**), analogous to the horizontal bars described above, for the web page **3912** or other structured document that helps a user understand what portion of the web page **3912** or other structured document is being displayed;

Share icon **3966** (FIG. **39I**) that when activated (e.g., by a finger tap on the icon) initiates display of a UI for sharing information with other users (e.g., UI **3900K**, FIG. **39K**);

URL clear icon **3970** (FIG. **39H**) that when activated (e.g., by a finger tap on the icon) clears any input in URL entry box **3908**;

Search term entry box **3972** (FIG. **39H**) for inputting search terms for web searches;

URL suggestion list **3974** (FIG. **39H**) that displays URLs that match the input in URL entry box **3908** (FIG. **39I**), wherein activation of a suggested URL (e.g., by a finger tap on the suggested URL) initiates retrieval of the corresponding web page;

URL input keyboard **3976** (FIGS. **39I** and **39M**) with period key **3978**, backslash key **3980**, and “.com” key **3982** that make it easier to enter common characters in URLs;

Search term clear icon **3984** that when activated (e.g., by a finger tap on the icon) clears any input in search term entry box **3972**;

Email link icon **3986** (FIG. **39K**) that when activated (e.g., by a finger tap or other gesture on the icon) prepares an email that contains a link to be shared with one or more other users;

Email content icon **3988** (FIG. **39K**) that when activated (e.g., by a finger tap or other gesture on the icon) prepares an email that contains content to be shared with one or more other users;

IM link icon **3990** (FIG. **39K**) that when activated (e.g., by a finger tap or other gesture on the icon) prepares an IM that contains a link to be shared with one or more other users; and

Cancel icon **3992** (FIG. **39K**) that when activated (e.g., by a finger tap or other gesture on the icon) cancels the sharing UI and displays the previous UI.

In some embodiments, in response to a predefined gesture by the user on a block **3914** (e.g., a single tap gesture or a double tap gesture), the block is enlarged and centered (or substantially centered) in the web page display. For example, in response to a single tap gesture **3923** on block **3914-5**, block **3914-5** may be enlarged and centered in the display, as shown in UI **3900C**, FIG. **39C**. In some embodiments, the width of the block is scaled to fill the touch screen display. In some embodiments, the width of the block is scaled to fill the touch screen display with a predefined amount of padding along the sides of the display. In some embodiments, a zooming animation of the block is displayed during enlargement of the block. Similarly, in response to a single tap gesture **3925** on block **3914-2**, block **3914-2** may be enlarged with a zooming animation and two-dimensionally scrolled to the center of the display (not shown).

In some embodiments, the device analyzes the render tree of the web page **3912** to determine the blocks **3914** in the web page. In some embodiments, a block **3914** corresponds to a render node that is: replaced; a block; an inline block; or an inline table.

In some embodiments, in response to the same predefined gesture by the user on a block **3914** (e.g., a single tap gesture or a double tap gesture) that is already enlarged and centered, the enlargement and/or centering is substantially or completely reversed. For example, in response to a single tap gesture **3929** (FIG. **39C**) on block **3914-5**, the web page image may zoom out and return to UI **3900A**, FIG. **39A**.

In some embodiments, in response to a predefined gesture (e.g., a single tap gesture or a double tap gesture) by the user on a block **3914** that is already enlarged but not centered, the block is centered (or substantially centered) in the web page display. For example, in response to a single tap gesture **3927** (FIG. **39C**) on block **3914-4**, block **3914-4** may be centered (or substantially centered) in the web page display. Similarly,

in response to a single tap gesture **3935** (FIG. **39C**) on block **3914-6**, block **3914-6** may be centered (or substantially centered) in the web page display. Thus, for a web page display that is already enlarged, in response to a predefined gesture, the device may display in an intuitive manner a series of blocks that the user wants to view. This same gesture may initiate different actions in different contexts (e.g., (1) zooming and/or enlarging in combination with scrolling when the web page is reduced in size, UI **3900A** and (2) reversing the enlargement and/or centering if the block is already centered and enlarged).

In some embodiments, in response to a multi-touch **3931** and **3933** de-pinching gesture by the user (FIG. **39C**), the web page may be enlarged. Conversely, in response to a multi-touch pinching gesture by the user, the web page may be reduced.

In some embodiments, in response to a substantially vertical upward (or downward) swipe gesture by the user, the web page (or, more generally, other electronic documents) may scroll one-dimensionally upward (or downward) in the vertical direction. For example, in response to an upward swipe gesture **3937** by the user that is within a predetermined angle (e.g., 27°) of being perfectly vertical, the web page may scroll one-dimensionally upward in the vertical direction.

Conversely, in some embodiments, in response to a swipe gesture that is not within a predetermined angle (e.g., 27°) of being perfectly vertical, the web page may scroll two-dimensionally (i.e., with simultaneous movement in both the vertical and horizontal directions). For example, in response to an upward swipe gesture **3939** (FIG. **39C**) by the user that is not within a predetermined angle (e.g., 27°) of being perfectly vertical, the web page may scroll two-dimensionally along the direction of the swipe **3939**.

In some embodiments, in response to a multi-touch **3941** and **3943** rotation gesture by the user (FIG. **39C**), the web page may be rotated exactly 90° (UI **3900D**, FIG. **39D**) for landscape viewing, even if the amount of rotation in the multi-touch **3941** and **3943** rotation gesture is substantially different from 90°. Similarly, in response to a multi-touch **3945** and **3947** rotation gesture by the user (UI **3900D**, FIG. **39D**), the web page may be rotated exactly 90° for portrait viewing, even if the amount of rotation in the multi-touch **3945** and **3947** rotation gesture is substantially different from 90°.

Thus, in response to imprecise gestures by the user, precise movements of graphics occur. The device behaves in the manner desired by the user despite inaccurate input by the user. Also, note that the gestures described for UI **3900C**, which has a portrait view, are also applicable to UIs with a landscape view (e.g., UI **3900D**, FIG. **3900D**) so that the user can choose whichever view the user prefers for web browsing.

In some embodiments, a portable electronic device with a touch screen display (e.g., device **100**) displays at least a portion of a structured electronic document on the touch screen display. The structured electronic document comprises a plurality of boxes of content (e.g., blocks **3914**, FIG. **39A**).

In some embodiments, the plurality of boxes are defined by a style sheet language. In some embodiments, the style sheet language is a cascading style sheet language. In some embodiments, the structured electronic document is a web page (e.g., web page **3912**, FIG. **39A**). In some embodiments, the structured electronic document is an HTML or XML document.

In some embodiments, displaying at least a portion of the structured electronic document comprises scaling the document width to fit within the touch screen display width independent of the document length.

US 7,479,949 B2

65

In some embodiments, the touch screen display is rectangular with a short axis and a long axis; the display width corresponds to the short axis when the structured electronic document is seen in portrait view (e.g., FIG. 39C); and the display width corresponds to the long axis when the structured electronic document is seen in landscape view (e.g., FIG. 39D).

In some embodiments, prior to displaying at least a portion of a structured electronic document, borders, margins, and/or paddings are determined for the plurality of boxes and adjusted for display on the touch screen display. In some embodiments, all boxes in the plurality of boxes are adjusted. In some embodiments, just the first box is adjusted. In some embodiments, just the first box and boxes adjacent to the first box are adjusted.

A first gesture is detected at a location on the displayed portion of the structured electronic document (e.g., gesture 3923, FIG. 39A). In some embodiments, the first gesture is a finger gesture. In some embodiments, the first gesture is a stylus gesture.

In some embodiments, the first gesture is a tap gesture. In some embodiments, the first gesture is a double tap with a single finger, a double tap with two fingers, a single tap with a single finger, or a single tap with two fingers.

A first box (e.g., Block 5 3914-5, FIG. 39A) in the plurality of boxes is determined at the location of the first gesture. In some embodiments, the structured electronic document has an associated render tree with a plurality of nodes and determining the first box at the location of the first gesture comprises: traversing down the render tree to determine a first node in the plurality of nodes that corresponds to the detected location of the first gesture; traversing up the render tree from the first node to a closest parent node that contains a logical grouping of content; and identifying content corresponding to the closest parent node as the first box. In some embodiments, the logical grouping of content comprises a paragraph, an image, a plugin object, or a table. In some embodiments, the closest parent node is a replaced inline, a block, an inline block, or an inline table.

The first box is enlarged and substantially centered on the touch screen display (e.g., Block 5 3914-5, FIG. 39C). In some embodiments, enlarging and substantially centering comprises simultaneously zooming and translating the first box on the touch screen display. In some embodiments, enlarging comprises expanding the first box so that the width of the first box is substantially the same as the width of the touch screen display.

In some embodiments, text in the enlarged first box is resized to meet or exceed a predetermined minimum text size on the touch screen display. In some embodiments, the text resizing comprises: determining a scale factor by which the first box will be enlarged; dividing the predetermined minimum text size on the touch screen display by the scaling factor to determine a minimum text size for text in the first box; and if a text size for text in the first box is less than the determined minimum text size, increasing the text size for text in the first box to at least the determined minimum text size. In some embodiments, the first box has a width; the display has a display width; and the scale factor is the display width divided by the width of the first box prior to enlarging. In some embodiments, the resizing occurs during the enlarging. In some embodiments, the resizing occurs after the enlarging.

In some embodiments, text in the structured electronic document is resized to meet or exceed a predetermined minimum text size on the touch screen display. In some embodiments, the text resizing comprises: determining a scale factor

66

by which the first box will be enlarged; dividing the predetermined minimum text size on the touch screen display by the scaling factor to determine a minimum text size for text in the structured electronic document; and if a text size for text in the structured electronic document is less than the determined minimum text size, increasing the text size for text in the structured electronic document to at least the determined minimum text size. In some embodiments, the text resizing comprises: identifying boxes containing text in the plurality of boxes; determining a scale factor by which the first box will be enlarged; dividing the predetermined minimum text size on the touch screen display by the scaling factor to determine a minimum text size for text in the structured electronic document; and for each identified box containing text, if a text size for text in the identified box is less than the determined minimum text size, increasing the text size for text in the identified box to at least the determined minimum text size and adjusting the size of the identified box.

In some embodiments, a second gesture (e.g., gesture 3929, FIG. 39C) is detected on the enlarged first box. In response to detecting the second gesture, the displayed portion of the structured electronic document is reduced in size. In some embodiments, the first box returns to its size prior to being enlarged.

In some embodiments, the second gesture and the first gesture are the same type of gesture. In some embodiments, the second gesture is a finger gesture. In some embodiments, the second gesture is a stylus gesture.

In some embodiments, the second gesture is a tap gesture. In some embodiments, the second gesture is a double tap with a single finger, a double tap with two fingers, a single tap with a single finger, or a single tap with two fingers.

In some embodiments, while the first box is enlarged, a third gesture (e.g., gesture 3927 or gesture 3935, FIG. 39C) is detected on a second box other than the first box. In response to detecting the third gesture, the second box is substantially centered on the touch screen display. In some embodiments, the third gesture and the first gesture are the same type of gesture. In some embodiments, the third gesture is a finger gesture. In some embodiments, the third gesture is a stylus gesture.

In some embodiments, the third gesture is a tap gesture. In some embodiments, the third gesture is a double tap with a single finger, a double tap with two fingers, a single tap with a single finger, or a single tap with two fingers.

In some embodiments, a swipe gesture (e.g., gesture 3937 or gesture 3939, FIG. 39C) is detected on the touch screen display. In response to detecting the swipe gesture, the displayed portion of the structured electronic document is translated on the touch screen display. In some embodiments, the translating comprises vertical, horizontal, or diagonal movement of the structured electronic document on the touch screen display. In some embodiments, the swipe gesture is a finger gesture. In some embodiments, the swipe gesture is a stylus gesture.

In some embodiments, a fifth gesture (e.g., multi-touch gesture 3941/3943, FIG. 39C) is detected on the touch screen display. In response to detecting the fifth gesture, the displayed portion of the structured electronic document is rotated on the touch screen display by 90°. In some embodiments, the fifth gesture is a finger gesture. In some embodiments, the fifth gesture is a multifinger gesture. In some embodiments, the fifth gesture is a twisting multifinger gesture.

In some embodiments, a change in orientation of the device is detected. In response to detecting the change in orientation

US 7,479,949 B2

67

of the device, the displayed portion of the structured electronic document is rotated on the touch screen display by 90°.

In some embodiments, a multi-finger de-pinch gesture (e.g., multi-touch gesture **3931/3933**, FIG. **39C**) is detected on the touch screen display. In response to detecting the multi-finger de-pinch gesture, a portion of the displayed portion of the structured electronic document is enlarged on the touch screen display in accordance with a position of the multi-finger de-pinch gesture and an amount of finger movement in the multi-finger de-pinch gesture.

A graphical user interface (e.g., UI **3900A**, FIG. **39A**) on a portable electronic device with a touch screen display comprises at least a portion of a structured electronic document (e.g., web page **3912**, FIG. **39A**). The structured electronic document comprises a plurality of boxes of content (e.g., blocks **3914**, FIG. **39A**). In response to detecting a first gesture (e.g., gesture **3923**, FIG. **39A**) at a location on the portion of the structured electronic document, a first box (e.g., Block **5 3914-5**, FIG. **39A**) in the plurality of boxes at the location of the first gesture is determined and the first box is enlarged and substantially centered on the touch screen display (e.g., Block **5 3914-5**, FIG. **39C**).

Additional description of displaying structured electronic documents (e.g., web pages) can be found in U.S. Provisional Patent Application No. 60/946,715, "Portable Electronic Device, Method, and Graphical User Interface for Displaying Structured Electronic Documents," filed Jun. 27, 2007, and U.S. patent application Ser. No. 11/850,013, "Portable Electronic Device, Method, and Graphical User Interface for Displaying Structured Electronic Documents," filed Sep. 4, 2007, the content of which is hereby incorporated by reference in its entirety.

In some embodiments, if a link in a web page in the browser **147** is activated that corresponds to an online video (e.g., a YouTube video), the corresponding online video is shown in the online video application **155**, rather than in the browser **147**. Similarly, in some embodiment, if a URL is input in the browser **147** that corresponds to an online video (e.g., a YouTube video), the corresponding online video is shown in the online video application **155**, rather than in the browser **147**. Redirecting the online video URL to the online video application **155** provides an improved viewing experience because the user does not need to navigate on a web page that includes the requested online video.

In some embodiments, if a link in a web page in the browser **147** is activated that corresponds to an online map request (e.g., a Google map request), the corresponding map is shown in the map application **154**, rather than in the browser **147**. Similarly, in some embodiment, if a URL is input in the browser **147** that corresponds to an online map request (e.g., a Google map request), the corresponding map is shown in the map application **154**, rather than in the browser **147**. Redirecting the map request URL to the map application **154** provides an improved viewing experience because the user does not need to navigate on a web page that includes the requested map.

In some embodiments, in response to a tap or other predefined user gesture on URL entry box **3908**, the touch screen displays an enlarged entry box **3926** and a keyboard **616** (e.g., UI **3900B**, FIG. **3900B** in portrait viewing and UI **3900E**, FIG. **39E** in landscape viewing). In some embodiments, the touch screen also displays:

Contextual clear icon **3928** that when activated (e.g., by a finger tap on the icon) initiates deletion of all text in entry box **3926**;

68

a search icon **3930** that when activated (e.g., by a finger tap on the icon) initiates an Internet search using the search terms input in box **3926**;

Go to URL icon **3932** that when activated (e.g., by a finger tap on the icon) initiates acquisition of the web page with the URL input in box **3926**; and

Cancel icon **3924** that when activated (e.g., by a finger tap on the icon) replaces display of the enlarged entry box **3926** and keyboard **616** with URL entry box **3908** and no keyboard (e.g., FIG. **39D**).

Thus, the same entry box **3926** may be used for inputting both search terms and URLs. In some embodiments, whether or not clear icon **3928** is displayed depends on the context.

UI **3900G** (FIG. **39G**) is a UI for adding new windows to an application, such as the browser **147**. UI **3900G** displays an application (e.g., the browser **147**), which includes a displayed window (e.g., web page **3912-2**) and at least one hidden window (e.g., web pages **3912-1** and **3912-3** and possibly other web pages that are completely hidden off-screen). UI **3900G** also displays an icon for adding windows to the application (e.g., new window or new page icon **3936**). In response to detecting activation of the icon **3936** for adding windows, the browser adds a window to the application (e.g., a new window for a new web page **3912**).

In response to detecting a gesture on the touch screen display, a displayed window in the application is moved off the display and a hidden window is moved onto the display. For example, in response to detecting a tap gesture **3949** on the left side of the screen, the window with web page **3912-2** is moved partially or fully off-screen to the right, the window with web page **3912-3** is moved completely off-screen, partially hidden window with web page **3912-1** is moved to the center of the display, and another completely hidden window with a web page (e.g., **3912-0**) may be moved partially onto the display. Alternatively, detection of a left-to-right swipe gesture **3951** may achieve the same effect.

Conversely, in response to detecting a tap gesture **3953** on the right side of the screen, the window with web page **3912-2** is moved partially or fully off-screen to the left, the window with web page **3912-1** is moved completely off-screen, partially hidden window with web page **3912-3** is moved to the center of the display, and another completely hidden window with a web page (e.g., **3912-4**) may be moved partially onto the display. Alternatively, detection of a right-to-left swipe gesture **3951** may achieve the same effect.

In some embodiments, in response to a tap or other predefined gesture on a delete icon **3934**, the corresponding window **3912** is deleted. In some embodiments, in response to a tap or other predefined gesture on Done icon **3938**, the window in the center of the display (e.g., **3912-2**) is enlarged to fill the screen.

Additional description of adding windows to an application can be found in U.S. patent application Ser. No. 11/620,647, "Method, System, And Graphical User Interface For Viewing Multiple Application Windows," filed Jan. 5, 2007, the content of which is hereby incorporated by reference in its entirety.

FIGS. **40A-40F** illustrate exemplary user interfaces for playing an item of inline multimedia content in accordance with some embodiments.

In some embodiments, user interfaces **4000A-4000F** include the following elements, or a subset or superset thereof:

402, 404, 406, 3902, 3906, 3910, 3912, 3918, 3920, 3922, as described above;

inline multimedia content **4002**, such as QuickTime content (**4002-1**), Windows Media content (**4002-2**), or Flash content (**4002-3**);

other types of content **4004** in the structured document, such as text;

Exit icon **4006** that when activated (e.g., by a finger tap on the icon) initiates exiting the inline multimedia content player UI (e.g., UI **4000B** or **4000F**) and returning to another UI (e.g., UI **4000A**, FIG. **40A**);

Lapsed time **4008** that shows how much of the inline multimedia content **4002** has been played, in units of time;

Progress bar **4010** that indicates what fraction of the inline multimedia content **4002** has been played and that may be used to help scroll through the inline multimedia content in response to a user gesture;

Remaining time **4012** that shows how much of the inline multimedia content **4002** remains to be played, in units of time;

Downloading icon **4014** that indicates when inline multimedia content **4002** is being downloaded or streamed to the device;

Fast Reverse/Skip Backwards icon **4016** that when activated (e.g., by a finger tap on the icon) initiates reversing or skipping backwards through the inline multimedia content **4002**;

Play icon **4018** that when activated (e.g., by a finger tap **4026** (FIG. **40C**) on the icon) initiates playing the inline multimedia content **4002**, either from the beginning or from where the inline multimedia content was paused;

Fast Forward/Skip Forward icon **4020** that initiates forwarding or skipping forwards through the inline multimedia content **4002**;

Volume adjustment slider icon **4022** that that when activated (e.g., by a finger tap on the icon) initiates adjustment of the volume of the inline multimedia content **4002**; and

Pause icon **4024** that when activated (e.g., by a finger tap on the icon) initiates pausing the inline multimedia content **4002**.

In some embodiments, a portable electronic device (e.g., **100**) displays at least a portion of a structured electronic document on a touch screen display. The structured electronic document comprises content (e.g., **4002** and **4004**). In some embodiments, the structured electronic document is a web page (e.g. **3912**). In some embodiments, the structured electronic document is an HTML or XML document.

A first gesture (e.g., **4028**, FIG. **40A**) is detected on an item of inline multimedia content (e.g., **4002-1**, FIG. **40A**) in the displayed portion of the structured electronic document. In some embodiments, the inline multimedia content comprises video and/or audio content. In some embodiments, the content can be played with a QuickTime, Windows Media, or Flash plug in.

In response to detecting the first gesture, the item of inline multimedia content is enlarged on the touch screen display and other content (e.g., **4004** and other **4002** besides **4002-1**, FIG. **4000A**) in the structured electronic document besides the enlarged item of inline multimedia content ceases to be displayed (e.g., UI **4000B**, FIG. **40B** or UI **4000F**, FIG. **40F**).

In some embodiments, enlarging the item of inline multimedia content comprises animated zooming in on the item. In some embodiments, enlarging the item of inline multimedia content comprises simultaneously zooming and translating the item of inline multimedia content on the touch screen display. In some embodiments, enlarging the item of inline

multimedia content comprises rotating the item of inline multimedia content by 90° (e.g., from UI **4000A**, FIG. **40A** to UI **4000B**, FIG. **40B**).

In some embodiments, the item of inline multimedia content has a full size; the touch screen display has a size; and enlarging the item of inline multimedia content comprises enlarging the item of inline multimedia content to the smaller of the full size of the item and the size of the touch screen display.

In some embodiments, enlarging the item of inline multimedia content comprises expanding the item of inline multimedia content so that the width of the item of inline multimedia content is substantially the same as the width of the touch screen display (e.g., UI **4000B**, FIG. **40B** or UI **4000F**, FIG. **40F**).

In some embodiments, ceasing to display other content in the structured electronic document besides the item of inline multimedia content comprises fading out the other content in the structured electronic document besides the item of inline multimedia content.

While the enlarged item of inline multimedia content is displayed, a second gesture is detected on the touch screen display (e.g., **4030**, FIG. **40B**).

In response to detecting the second gesture, one or more playback controls for playing the enlarged item of inline multimedia content are displayed. In some embodiments, the one or more playback controls comprise a play icon (e.g., **4018**), a pause icon (e.g., **4024**), a sound volume icon (e.g., **4022**), and/or a playback progress bar icon (e.g., **4010**).

In some embodiments, displaying one or more playback controls comprises displaying one or more playback controls on top of the enlarged item of inline multimedia content (e.g., playback controls **4016**, **4018**, **4020**, and **4022** are on top of enlarged inline multimedia content **4002-1** in FIG. **40C**). In some embodiments, the one or more playback controls are superimposed on top of the enlarged item of inline multimedia content. In some embodiments, the one or more playback controls are semitransparent.

In some embodiments, an instruction in the structured electronic document to automatically start playing the item of inline multimedia content is overridden, which gives the device time to download more of the selected inline multimedia content prior to starting playback.

A third gesture is detected on one of the playback controls (e.g., gesture **4026** on play icon **4018**, FIG. **40C**).

In response to detecting the third gesture, the enlarged item of inline multimedia content is played. In some embodiments, playing the enlarged item of inline multimedia content comprises playing the enlarged item of inline multimedia content with a plugin for a content type associated with the item of inline multimedia content.

In some embodiments, while the enlarged item of inline multimedia content is played, the one or more playback controls cease to be displayed (e.g., FIG. **40D**, which no longer displays playback controls **4016**, **4018**, **4020**, and **4022**, but still shows **4006**, **4008**, **4010**, and **4012**). In some embodiments, all of the playback controls cease to be displayed. In some embodiments, ceasing to display the one or more playback controls comprises fading out the one or more playback controls. In some embodiments, the display of the one or more playback controls is ceased after a predetermined time. In some embodiments, the display of the one or more playback controls is ceased after no contact is detected with the touch screen display for a predetermined time.

In some embodiments, a fourth gesture is detected on the touch screen display. In response to detecting the fourth gesture, at least the portion of the structured electronic document

US 7,479,949 B2

71

is displayed again (e.g., FIG. 40A). In some embodiments, the fourth gesture comprises a tap gesture on a playback completion icon, such as a done icon (e.g., gesture 4032 on done icon 4006, FIG. 40D). In some embodiments, the item of inline multimedia content returns to its size prior to being enlarged.

In some embodiments, the first, second, and third gestures are finger gestures. In some embodiments, the first, second, and third gestures are stylus gestures.

In some embodiments, the first, second, and third gestures are tap gestures. In some embodiments, the tap gesture is a double tap with a single finger, a double tap with two fingers, a single tap with a single finger, or a single tap with two fingers.

A graphical user interface on a portable electronic device with a touch screen display, comprises: at least a portion of a structured electronic document, wherein the structured electronic document comprises content; an item of inline multimedia content in the portion of the structured electronic document; and one or more playback controls. In response to detecting a first gesture on the item of inline multimedia content, the item of inline multimedia content on the touch screen display is enlarged, and display of other content in the structured electronic document besides the enlarged item of inline multimedia content is ceased. In response to detecting a second gesture on the touch screen display while the enlarged item of inline multimedia content is displayed, the one or more playback controls for playing the enlarged item of inline multimedia content are displayed. In response to detecting a third gesture on one of the playback controls, the enlarged item of inline multimedia content is played.

Additional description of displaying inline multimedia content can be found in U.S. Provisional Patent Application No. 60/947,155, "Portable Electronic Device, Method, and Graphical User Interface for Displaying Inline Multimedia Content," filed Jun. 29, 2007, and U.S. patent application Ser. No. 11/961,773, "Portable Electronic Device, Method, and Graphical User Interface for Displaying Inline Multimedia Content," filed Dec. 20, 2007, the content of which is hereby incorporated by reference in its entirety.

FIGS. 41A-41E illustrate exemplary user interfaces for interacting with user input elements in displayed content in accordance with some embodiments.

In some embodiments, user interfaces 4100A-4100E include the following elements, or a subset or superset thereof:

402, 404, 406, 616, 618, 620, 3902, 3906, 3910, 3912, 3918, 3920, and 3922, as described above;

content 4112, such as a web page; word processing, spreadsheet, email or presentation document; electronic form; or online form;

user input elements 4102 in the content 4112, such as radio buttons, text input fields, check boxes, pull down lists, and/or form fields;

information 4108 about a chosen user input element 4102; area 4114 that includes a chosen user input element 4102; cancel icon 4116 (FIG. 41B) that when activated (e.g., by a finger tap on the icon) cancels user input into the chosen element 4102;

input choices 4118 that when activated (e.g., by a finger tap on the icon) are used as input for the chosen element 4102;

done icon 4124 (FIG. 41E) that when activated (e.g., by a finger tap on the icon) returns the device to the previous UI (e.g., UI 4100D, FIG. 41D); and

72

submit icon 4126 (FIG. 41E) that when activated (e.g., by a finger tap on the icon) sends the input to a remote server.

In some embodiments, a portable multifunction device (e.g., device 100) displays content 4112 on a touch screen display. The content includes a plurality of user input elements 4102.

In some embodiments, the content is a web page (e.g., page 3912, FIG. 41A). In some embodiments, the content is a word processing, spreadsheet, email or presentation document. In some embodiments, the content is an electronic form. In some embodiments, the content is an online form.

In some embodiments, the user input elements 4102 include one or more radio buttons, text input fields, check boxes, pull down lists (e.g., 4102-1, FIG. 41A), and/or form fields (e.g., user name 4102-3, FIG. 41A).

A contact by a finger (e.g., 4104, FIG. 41A) is detected with the touch screen display. The contact includes an area of contact.

A point (e.g., 4106, FIG. 41A) is determined within the area of contact. In some embodiments, the point within the area of contact is the centroid of the area of contact. In some embodiments, the point within the area of contact is offset from the centroid of the area of contact.

A user input element in the plurality of user input elements is chosen based on proximity of the user input element to the determined point (e.g., 4102-1, FIG. 41A). In some embodiments, the content on the touch screen display has an associated scale factor, and the choosing is limited to user input elements located within a distance from the determined point that is determined in accordance with the scale factor. In some embodiments, choosing is limited to user input elements located within the area of contact. In some embodiments, choosing is limited to user input elements that at least partially overlap with the area of contact. In some embodiments, choosing is limited to user input elements located within a predetermined distance from the determined point.

Information associated with the chosen user input element is displayed over the displayed content (e.g., Accounts Menu 4108-1, FIG. 41A). In some embodiments, the displayed information associated with the chosen user input element comprises a description of the chosen user input element.

In some embodiments, the information associated with the chosen user input element is displayed outside the area of contact. In some embodiments, the location of the information associated with the chosen user input element over the displayed content depends on the location of the contact. In some embodiments, the location of the information associated with the chosen user input element is displayed over the top half of the displayed content if the location of the contact is in the bottom half of the displayed content and the location of the information associated with the chosen user input element is displayed over the bottom half of the displayed content if the location of the contact is in the top half of the displayed content.

In some embodiments, the information associated with the chosen user input element is displayed after the contact is maintained for at least a predetermined time. In some embodiments, the displayed information associated with the chosen user input element is removed if the contact with the touch screen is maintained for greater than a predetermined time.

A break is detected in the contact by the finger with the touch screen display. In some embodiments, detecting the break in the contact comprises detecting the break in the contact while the information associated with the chosen user input element is displayed.

US 7,479,949 B2

73

In some embodiments, in response to detecting the break in the contact by the finger with the touch screen display, an area is enlarged that includes the chosen user input element on the touch screen display (e.g., for element **4102-1**, area **4114-1** in FIG. **41A** is enlarged in FIG. **41B**; similarly, for elements **4102-3** and **4102-4**, area **4114-2** in FIG. **41D** is enlarged in FIG. **41E**).

In some embodiments, in response to detecting the break in the contact by the finger with the touch screen display prior to expiration of a predetermined time, the chosen user input element is enlarged on the touch screen display (e.g., element **4102-1** in FIG. **41A** is enlarged in FIG. **41B**; similarly, elements **4102-3** and **4102-4** in FIG. **41D** are enlarged in FIG. **41E**).

Input is received for the chosen user input element. In some embodiments, receiving input comprises: receiving text input via a soft keyboard on the touch screen display (e.g., keyboard **616**, FIG. **41E**), detecting a finger contact with a radio button on the touch screen display, detecting a finger contact with a check box on the touch screen display, or detecting a finger contact with an item in a pull down list on the touch screen display (e.g., contact **4120** on input choice **4118-3**, FIG. **41B**).

In some embodiments, the received input is sent to a remote computer, such as a web server.

In some embodiments, movement of the contact is detected on the touch screen display (e.g., movement **4110-1**, FIG. **41C**); a second user input element (e.g., element **4102-2**, FIG. **41C**) in the plurality of user input elements is chosen based on proximity of the second user input element to the contact (e.g., contact **4104**, FIG. **41C**); the display of information associated with the first chosen user input element over the displayed content is ended; and information associated with the second chosen user input element is displayed over the displayed content (e.g., sign in button **4108-2**, FIG. **41C**).

In some embodiments, movement of the contact on the touch screen display is detected (e.g., movement **4110-1** in FIG. **41C**, and movement **4110-2** in FIG. **41D**); a series of user input elements in the plurality of user input elements are chosen based on the proximity of the user input elements to the contact (e.g., element **4102-2** in FIG. **41C**, and elements **4102-3** and **4102-4** in FIG. **41D**); and information associated with each user input element in the series of user input elements are successively displayed over the displayed content (e.g., information **4108-3** in FIG. **41C**, and information **4108-4** in FIG. **41D**).

A graphical user interface (e.g., UI **4100A**, FIG. **41A**) on a portable multifunction device with a touch screen display comprises (1) content **4112** that includes a plurality of user input elements **4102** and (2) information **4108-1** associated with a first user input element **4102-1** in the plurality of user input elements. In response to the detection of an area of contact **4104** of a finger with the touch screen display: a point **4106** is determined within the area of contact, the first user input element **4102-1** is chosen based on proximity of the first user input element to the determined point, and the information **4108-1** associated with the first user input element is displayed over the content.

Using interfaces such as **4100A-4100E**, a user may more easily view information associated with input elements and provide input on a portable device using finger contacts on a touch screen. The user is relieved of having to worry about the precision of his finger contact with respect to selection of input elements. Furthermore, the user can view information and provide input even if the input elements are initially displayed at such a small size that the elements are illegible or barely legible.

74

Additional description of interacting with user input elements can be found in U.S. Provisional Patent Application No. 60/947,127, "Portable Multifunction Device, Method, and Graphical User Interface for Interacting with User Input Elements in Displayed Content," filed Jun. 29, 2007, and U.S. patent application Ser. No. 11/960,394, "Portable Multifunction Device, Method, and Graphical User Interface for Interacting with User Input Elements in Displayed Content," filed Dec. 19, 2007, the content of which is hereby incorporated by reference in its entirety.

FIG. **41F** illustrates an exemplary user interface for interacting with hyperlinks in displayed content in accordance with some embodiments.

In some embodiments, user interface UI **4100F** include the following elements, or a subset or superset thereof:

402, 404, 406, 3902, 3906, 3910, 3912, 3918, 3920, 3922, 4112, and 4102, as described above;

link **4122** that provides a link to other content; and information **4130** associated with link **4122**.

Additional description of displaying and activating hyperlinks using interfaces such as UI **4100F** can be found in U.S. patent application Ser. No. 11/620,644, "Method, System, And Graphical User Interface For Displaying Hyperlink Information," filed Jan. 5, 2007, and in U.S. patent application Ser. No. 11/620,646, "Method, System, And Graphical User Interface For Activating Hyperlinks," filed Jan. 5, 2007, the contents of which are hereby incorporated by reference in their entirety.

FIGS. **42A-42C** illustrate exemplary user interfaces for translating page content or translating just frame content within the page content in accordance with some embodiments.

In some embodiments, user interfaces **4200A-4200C** include the following elements, or a subset or superset thereof:

402, 404, 406, 3902, 3906, 3910, 3918, 3920, and 3922, as described above;

Portion **4202** of page content, such as web page content;

Frame **4204** that displays a portion **4206** of frame content;

Portion **4206** of frame content, such as a portion of a map or a scrollable list of items, that is displayed within frame **4204**;

Other content **4208**, besides the portion **4206** of frame content, in portion **4202**;

New portion **4212** of page content that is displayed in response to an N-finger translation gesture **4210**; and

New portion **4216** of frame content that is displayed in response to an M-finger translation gesture **4214**, where M is a different number from N (e.g., N=1 and M=2).

In some embodiments, a portable multifunction device (e.g., device **100**) displays a portion (e.g., **4202**, FIG. **42A**) of page content on a touch screen display. The portion **4202** of page content includes a frame **4204** displaying a portion **4206** of frame content and other content **4208** of the page.

In some embodiments, the page content is web page content. In some embodiments, the page content is a word processing, spreadsheet, email or presentation document.

An N-finger translation gesture (e.g., **4210**) is detected on or near the touch screen display.

In response to detecting the N-finger translation gesture **4210**, the page content is translated to display a new portion (e.g., **4212**, FIG. **42B**) of page content on the touch screen display. Translating the page content includes translating the displayed portion **4206** of the frame content and the other content **4208** of the page.

In some embodiments, translating the page content comprises translating the page content in a vertical, horizontal, or

US 7,479,949 B2

75

diagonal direction. In some embodiments, translating the page content has an associated direction of translation that corresponds to a direction of movement of the N-finger translation gesture **4210**. In some embodiments, the direction of translation corresponds directly to the direction of finger movement; in some embodiments, however, the direction of translation is mapped from the direction of finger movement in accordance with a rule. For example, the rule may state that if the direction of finger movement is within X degrees of a standard axis, the direction of translation is along the standard axis, and otherwise the direction of translation is substantially the same as the direction of finger movement.

In some embodiments, translating the page content has an associated speed of translation that corresponds to a speed of movement of the N-finger translation gesture. In some embodiments, translating the page content is in accordance with a simulation of an equation of motion having friction.

An M-finger translation gesture (e.g., **4214**, FIG. **42A**) is detected on or near the touch screen display, where M is a different number than N. In some embodiments, N is equal to 1 and M is equal to 2.

In response to detecting the M-finger translation gesture **4214**, the frame content is translated to display a new portion (e.g., **4216**, FIG. **42C**) of frame content on the touch screen display, without translating the other content **4208** of the page.

In some embodiments, translating the frame content comprises translating the frame content in a vertical, horizontal, or diagonal direction. In some embodiments, translating the frame content comprises translating the frame content in a diagonal direction.

In some embodiments, translating the frame content has an associated direction of translation that corresponds to a direction of movement of the M-finger translation gesture **4214**. In some embodiments, the direction of translation corresponds directly to the direction of finger movement; in some embodiments, however, the direction of translation is mapped from the direction of finger movement in accordance with a rule. For example, the rule may state that if the direction of finger movement is within Y degrees of a standard axis, the direction of translation is along the standard axis, and otherwise the direction of translation is substantially the same as the direction of finger movement.

In some embodiments, translating the frame content has an associated speed of translation that corresponds to a speed of movement of the M-finger translation gesture. In some embodiments, translating the frame content is in accordance with a simulation of an equation of motion having friction.

In some embodiments, the frame content comprises a map. In some embodiments, the frame content comprises a scrollable list of items.

In some embodiments, the other content **4208** of the page includes text.

A graphical user interface (e.g., UI **4200A**, FIG. **42A**) on a portable multifunction device with a touch screen display comprises a portion **4202** of page content on the touch screen display, which includes: (1) a frame **4204** displaying a portion **4206** of frame content and (2) other content **4208** of the page. In response to detecting an N-finger translation gesture **4210** on or near the touch screen display, the page content is translated to display a new portion **4212** (FIG. **42B**) of page content on the touch screen display, wherein translating the page content includes translating the other content **4208** of the page. In response to detecting an M-finger translation gesture **4214** on or near the touch screen display, where M is a different number than N, the frame content is translated to

76

display a new portion **4216** (FIG. **42C**) of frame content on the touch screen display, without translating the other content **4208** of the page.

Thus, depending on the number of fingers used in the gesture, a user may easily translate page content or just translate frame content within the page content.

Additional description of translating displayed content can be found in U.S. Provisional Patent Application No. 60/946, 976, "Portable Multifunction Device, Method, and Graphical User Interface for Translating Displayed Content," filed Jun. 28, 2007, and U.S. patent application Ser. No. 11/960,675, "Portable Multifunction Device, Method, and Graphical User Interface for Translating Displayed Content," filed Dec. 19, 2007, the content of which is hereby incorporated by reference in its entirety.

Music and Video Player

FIGS. **43A-43DD** illustrate exemplary user interfaces for a music and video player **152** in accordance with some embodiments.

In some embodiments, icons for major content categories (e.g., playlists **4308**, artists **4310**, songs **4312**, and video **4314**) are displayed in a first area of the display (e.g., **4340**, FIG. **43A**). In some embodiments, the first area also includes an icon (e.g., more icon **4316**) that when activated (e.g., by a finger tap on the icon) leads to additional content categories (e.g., albums, audiobooks, compilations, composers, genres, and podcasts in FIG. **43J**).

In some embodiments, the player **152** includes a now playing icon **4302** that when activated (e.g., by a finger tap on the icon) takes the user directly to a UI displaying information about the currently playing music (e.g., FIG. **43S**).

In some embodiments, in response to a series of gestures (e.g., finger taps) by the user, the device displays a series of content categories and sub-categories. For example, if the user activates selection icon **4306** (e.g., by a finger tap on the icon) or, in some embodiments, taps anywhere (e.g., tap **4304**) in the Top 25 row **4318**, the UI changes from a display of playlist categories (UI **4300A**, FIG. **43A**) to a display of the Top 25 sub-category (UI **4300B**, FIG. **43B**).

If just a portion of a category or sub-category is displayed, a vertical bar, analogous to the vertical bars described above, is displayed on top of the category/sub-category that helps a user understand what portion of the category/sub-category is being displayed (e.g., vertical bar **4320**, FIG. **43B**). In some embodiments, a user can scroll through the list of items in the category/sub-category by applying a vertical or substantially vertical swipe gesture **4322** to the area displaying the list. In some embodiments, a vertically downward gesture scrolls the list downward and a vertically upward gesture scrolls the list upward,

In some embodiments, if the user scrolls to the top of the list and then continues to apply a scrolling gesture (e.g., **4324**, FIG. **43C**), background **4326-1** appears and the vertical bar **4320-1** may start to reduce in length to indicate to the user that the top of the list has been reached. When the user's finger breaks contact with the touch screen display, the list may move back to the top of the display and the background **4326-1** shrinks to nothing. Similarly, if the user scrolls to the bottom of the list and then continues to apply a scrolling gesture (e.g., **4328**, FIG. **43D**), background **4326-2** appears and the vertical bar **4320-2** may start to reduce in length to indicate to the user that the bottom of the list has been reached. When the user's finger breaks contact with the touch screen display, the list may move back to the bottom of the display and the background **4326-2** shrinks to nothing. This "rubber band-like" behavior at the terminus of lists may be

applied to many other types of lists and documents that have vertical scrolling. Similar behavior may be applied to all of the edges of documents that can be translated in two dimensions (e.g., web pages, word processing documents, and photographs and other images). Additional description of this “rubber band-like” scrolling and translation behavior can be found in U.S. Provisional Patent Application Nos. 60/883, 801, “List Scrolling And Document Translation On A Touch-Screen Display,” filed Jan. 7, 2007; 60/945,858, “List Scrolling and Document Translation on a Touch-Screen Display,” filed Jun. 22, 2007, and 60/946,971, “List Scrolling and Document Translation on a Touch-Screen Display,” filed Jun. 28, 2007, and U.S. patent application Ser. No. 11/956,969, “List Scrolling and Document Translation, Scaling, and Rotation on a Touch-Screen Display,” filed Dec. 14, 2007, the contents of which are hereby incorporated by reference in their entirety.

In some embodiments, if the user activates artists icon **4310** (e.g., by a finger tap on the icon), the artists category will be displayed (FIG. **43E**). In some embodiments, such as when the artists list is arranged alphabetically, an index item/symbol (e.g., the letter A **4330-1**) may remain adjacent to a respective information item subset (e.g., artists **4332** whose name begins with the letter A). When scrolling up through the list of information items (e.g., in response to an upward swipe on the touch sensitive display by the user), the index item/symbol may move to the upper edge of a window (e.g., window **4336**, FIG. **43F**). As the scrolling continues (e.g., in response to gesture **4334**, FIG. **43F**), the index item/symbol may remain there until the end of the respective information item subset is reached, at which time the index item/symbol may be replaced with a subsequent index item/symbol (e.g., the letter B **4330-2**). An analogous scrolling effect is shown for the Movies **4330-3** and Music Videos **4330-4** index items in UI **4300H** and UI **4300I** (FIGS. **43H** and **43I**). Additional description of such scrolling is described in U.S. patent application Ser. Nos. 11/322,547, “Scrolling List With Floating Adjacent Index Symbols,” filed Dec. 23, 2005; 11/322,551, “Continuous Scrolling List With Acceleration,” filed Dec. 23, 2005; and 11/322,553, “List Scrolling In Response To Moving Contact Over List Of Index Symbols,” filed Dec. 23, 2005, which are hereby incorporated by reference in their entirety.

In some embodiments, if the user activates songs icon **4312** (e.g., by a finger tap on the icon), the songs category will be displayed (FIG. **43G**).

In some embodiments, if the user activates videos icon **4314** (e.g., by a finger tap on the icon), the video category will be displayed (FIG. **43H**).

In some embodiments, the major content categories that are displayed in the first area **4340** of the display can be rearranged by a user to correspond to the user’s preferred (favorite) categories (e.g., as illustrated in FIGS. **43J-43M** and FIGS. **43N-43P**). In some embodiments, activation of add category icon **4344** (e.g., by a finger tap on the icon) initiates display of a UI with a soft keyboard for adding user specified categories (not shown). In some embodiments, activation of edit icon **4342** in FIG. **43J** (e.g., by a finger tap on the icon) initiates display of UI **4300K** (FIG. **43K**) with delete icons **4348** (which operate like delete icons **702**, FIG. **7**, as described above) and moving affordance icons **4360**. As described below, moving affordance icons **4360** may be used as control icons that assist in rearranging categories or other UI objects.

In some embodiments, a portable multifunction device with a touch screen display with a plurality of user interface objects displays a first user interface object (e.g., genres icon

4350, FIG. **43K**) and a second user interface object (e.g., artists icon **4310**, FIG. **43K**) on the touch screen display. In some embodiments, the first user interface object is one of a group of candidate icons (e.g., icons in the more list **4362**, FIG. **43K**, which are candidates for rearrangement) and the second user interface object is one of a group of user favorite icons (e.g., icons in area **4340**).

A finger-down event is detected at the first user interface object (e.g., contact **4346-1**, FIG. **43K**). In some embodiments, the first user interface object includes a control icon (e.g., the horizontal bars comprising a moving affordance icon **4360** in genres icon **4350**) and the finger-down event occurs at or near the control icon.

One or more finger-dragging events are detected on the touch screen display (e.g., the finger drag from **4346-1** (FIG. **43K**) to **4346-2** (FIG. **43L**) to **4346-3** via **4365** (FIG. **43L**)).

The first user interface object is moved on the touch screen display along a path determined by the finger-dragging events until the first user interface object at least in part overlaps the second user interface object.

In some embodiments, while moving the first user interface object on the touch screen display, the first user interface object is displayed in a manner visually distinguishable from other user interface objects on the touch screen display (e.g., the shading around genres icon **4350** in FIG. **43L**).

A finger-up event is detected at the second user interface object (e.g., ending contact at **4346-3**, FIG. **43L**).

The second user interface object (e.g., artists icon **4310**, FIG. **43L**) is visually replaced with the first user interface object (e.g., genres icon **4350**, FIG. **43M**).

In some embodiments, upon detecting the finger-up event, the first user interface object is displayed at a location formerly occupied by the second user interface object, and a movement of the second user interface object to a location formerly occupied by the first user interface object is animated (e.g., in FIG. **43M**, artists **4310** is now part of the list that used to include genres **4350**).

In some embodiments, the first user interface object is displayed in a first form before the finger-up event and in a second form after the finger-up event, and the second form is visually different from the first form. In some embodiments, the first form is a row including characters and at least one control icon (e.g., **4350**, FIG. **43K**) and the second form is an image or other graphic (e.g., **4350**, FIG. **43M**).

In some embodiments, the second user interface object is displayed in a first form before the finger-up event and in a second form after the finger-up event, and the second form is visually different from the first form. In some embodiments, the first form is an image or other graphic (e.g., **4310**, FIG. **43K**) and the second form is a row (e.g., **4310**, FIG. **43M**) including characters associated with at least one control icon (e.g., **4360-2**, FIG. **43M**). In some embodiments, the second form is a row including characters near, or within a predefined distance, corresponding to a hit region for the control icon.

In some embodiments, the first user interface object is one of a group of candidate icons and the second user interface object is one of a group of user favorite icons. In some embodiments, the remaining group of candidate icons is rearranged after moving the first user interface object away from its original location. The remaining group of candidate icons is the group of candidate icons excluding the first user interface object. Upon detecting the finger-up event, the first user interface object is displayed at a location formerly occupied by the second user interface object and a movement of the second user interface object to a location formerly occupied by one of the remaining group of candidate icons is animated.

FIGS. 43N-43P illustrate another way the major content categories that are displayed in the first area 4340 of the display can be rearranged by a user to correspond to the user's preferred (favorite) categories. The categories that are included in area 4340 may also be listed in a first list area 4364 5 in the more list 4362 (e.g., above separator 4352 in the more list 4362), with the candidate categories listed in a second list area 4366 in the more list 4362 (e.g., below separator 4352 in the more list 4362). In response to detection of a finger down event (e.g., 4346-5, FIG. 43N); one or more finger dragging events (e.g., from 4346-5 to 4346-6 (FIG. 43O) to 4346-7 10 (FIG. 43P)); and a finger up event (e.g., at 4346-7), a first user interface object (e.g., genres icon 4350) may replace a second user interface object (e.g., artists icon 4310) in both the first list area 4364 and in area 4340 (e.g., 4350-1 and 4350-2, FIG. 43P), with the second user interface object moving to the second list area 4366 (e.g., 4310, FIG. 43P).

In some embodiments, a portable multifunction device displays a first group of user interface objects on the touch screen display (e.g., icons in the more list 4362, FIG. 43K, which are candidates for rearrangement). A second group of user interface objects is displayed on the touch screen display (e.g., icons in area 4340). A finger-down event is detected on the touch screen display (e.g., contact 4346-1, FIG. 43K). A first user interface object (e.g., genres icon 4350, FIG. 43K) in the first group at which the finger-down event occurs is identified. One or more finger-dragging events are detected on the touch screen display (e.g., the finger drag from 4346-1 (FIG. 43K) to 4346-2 (FIG. 43L) to 4346-3 via 4365 (FIG. 43L)). The first user interface object on the touch screen display is 30 moved in accordance with the finger-dragging events. A finger-up event is detected on the touch screen display (e.g., ending contact at 4346-3, FIG. 43L). A second user interface object (e.g., artists icon 4310, FIG. 43K) in the second group at which the finger-up event occurs is identified. The second user interface object is visually replaced with the first user interface object (e.g., artists icon 4310 in FIG. 43L is visually replaced with genres icon 4350 in FIG. 43M).

Additional description of user interface object reconfiguration can be found in U.S. Provisional Patent Application No. 60/937,990, "Portable Multifunction Device, Method, and Graphical User Interface Supporting User Navigations of Graphical Objects on a Touch Screen Display," filed Jun. 29, 2007, and U.S. patent application Ser. No. 11/969,809, "Portable Multifunction Device, Method, and Graphical User Interface Supporting User Navigations of Graphical Objects on a Touch Screen Display," filed Jan. 4, 2008, the content of which is hereby incorporated by reference in its entirety.

U.S. Provisional Patent Application No. 60/936,562, "Portable Multifunction Device, Method, and Graphical User Interface for Playing Online Videos," filed Jun. 20, 2007, and U.S. patent application Ser. No. 11/968,067, "Portable Multifunction Device, Method, and Graphical User Interface for Playing Online Videos," filed Dec. 31, 2007, the content of which is hereby incorporated by reference in its entirety, 55 describes a way that major online video content categories can be rearranged by a user to correspond to the user's preferred (favorite) categories. The teachings in that application are also applicable here to rearranging major music and/or video categories.

Referring again to the user interface 4300J in FIG. 43J, a list of content categories (e.g., Albums) is displayed on the touch screen display. FIGS. 43Q-43T and 43W-43AA are exemplary user interfaces illustrating these content categories in detail in accordance with some embodiments.

FIG. 43Q is an exemplary user interface for Albums category 4371, which is displayed in response to a user selection

of the corresponding album category icon in FIG. 43J. In some embodiments, user interface 4300Q includes the following elements, or a subset or superset thereof:

- More icon 4373, which, if selected (e.g., by a finger tap on the icon), brings back display of user interface 4300J;

- Now Playing icon 4302 that when activated (e.g., by a finger tap on the icon) takes the user directly to a UI displaying information about the currently playing content (e.g., FIG. 43S);

- One or more alphabetic icons 4375-1, 4375-2;

- One or more individual album icons 4377-1 to 4377-5, which are grouped under different alphabetic icons; and
- Alphabetic list 4379 that helps a user to navigate quickly through the list of albums to albums beginning with a particular letter.

FIG. 43R is an exemplary user interface for presenting tracks (e.g., songs) within an album, which is displayed in response to a user selection 4370 of an individual album (e.g., "Abbey Road" 4377-1 in FIG. 43Q). In some embodiments, user interface 4300R includes the following elements, or a subset or superset thereof:

- Albums icon 4374, which, if selected (e.g., by a finger tap on the icon), brings back display of user interface 4300Q;

- Now Playing icon 4302, described above;

- Shuffle song playing order icon 4376;

- One or more individual song icons 4372-1 to 4372-7; and
- Vertical bar 4398, analogous to the vertical bars described above, which is displayed on top of the list of tracks in the album and which helps a user understand what portion of the list of tracks is being displayed.

FIG. 43S is an exemplary user interface for playing a track, which is displayed in response to a user selection (e.g., by gesture 4378 in FIG. 43R) of an individual track (e.g., "Come together" 4372-1 in FIG. 43R) or now playing icon 4302. In some embodiments, user interface 4300S includes the following elements, or a subset or superset thereof:

- Back icon 4380-1, which, if selected (e.g., by a finger tap on the icon), brings back display of the previous user interface (e.g., 4300R);

- Cover flip icon 4380-2, which, if selected (e.g., by a finger tap on the icon), flips the album cover 4380-4 over and displays a list of tracks in the album;

- Repeat track play icon 4380-7, which, if selected (e.g., by a finger tap on the icon), repeats the currently playing track;

- Shuffle track play icon 4380-8 which, if selected (e.g., by a finger tap on the icon), plays the tracks on the album in a random order;

- Progress bar 4380-3 that indicates what fraction of the track has been played and that may be used to help scroll through the track in response to a user gesture;

- Album Cover 4380-4 that corresponds to the track, which may be automatically generated by the device or imported into the device from a different source; and

- Music play control icons 4380-5, which may include a Fast Reverse/Skip Backwards icon, a Fast Forward/Skip Forward icon, a Volume adjustment slider icon, a Pause icon, and/or a Play icon (not shown, which toggles with the Pause icon) that behave in an analogous manner to icons 2320, 2322, 2324, 2306, and 2304 described above with respect to the video player (FIGS. 23A-23D).

In some embodiments, the repeat track play icon 4380-7, the progress bar 4380-3, and the shuffle track play icon 4380-8 appear on the touch screen display in response to a finger gesture on the display.

In some embodiments, the music play control icons **4380-5** appear on the touch screen display whenever a finger contact with the display is detected. The icons **4380-5** may stay on the display for a predefined time period (e.g., a few seconds) and then disappear until the next finger contact with the touch screen display is detected.

FIG. **43T** is an exemplary user interface of an enlarged album cover, which may be displayed in response to a user selection **4381** of the album cover **4380-4** in FIG. **43S**. In some embodiments, user interface **4300T** includes the same elements shown in FIG. **43S**, except, user interface **4300T** includes an enlarged version **4380-6** of the album cover **4380-4**.

In light of the description above of the Album category, the operation of other content categories in the More list (FIG. **43J**) will be apparent to one skilled in the art.

For example, FIG. **43W** is an exemplary user interface for a Genres category, which is displayed in response to a user selection of the corresponding category icon in FIG. **43J**. Each music genre occupies one row on the touch screen. A user can scroll through the list by vertical finger swipes.

FIG. **43X** is an exemplary user interface for a particular genre, which is displayed in response to a user selection (e.g., by gesture **4383** in FIG. **43W**) of one individual album (e.g., “Rock” in FIG. **43W**). Exemplary information presented in UI **4300X** may include songs and albums, music bands and artists associated with the particular genre.

FIG. **43Y** is an exemplary user interface for a Composers category, which is displayed in response to a user selection of the corresponding category icon in FIG. **43J**.

FIG. **43Z** is an exemplary user interface for a Compilations category, which is displayed in response to a user selection of the corresponding category icon in FIG. **43J**.

FIG. **43AA** is an exemplary user interface for a particular compilation, which is displayed in response to a user selection (e.g., by gesture **4385** in FIG. **43Z**) of an individual compilation (e.g., “Gold” in FIG. **43Z**). Exemplary information presented in UI **4300AA** may include the songs associated with the particular compilation.

FIG. **43BB** is an exemplary user interface for a song currently being played in response to a user selection (e.g., by gesture **4387** in FIG. **43AA**) of the Now Playing icon **4302** in FIG. **43AA**. In this particular example, the song currently being played is still “Come Together” from the album “Abbey Road”. Therefore, user interface **4300BB** is virtually the same as user interface **4300S** except that the played timestamp and remaining timestamp have been altered.

As illustrated in FIG. **43U** and FIG. **43V**, a user rating may be applied to an item of content with a finger gesture.

In some embodiments, a portable multifunction device displays a series of ratings indicia (e.g., **4382**, FIGS. **43U** and **43V**) on a touch screen display. The ratings indicia comprise a lowest rating indicia and one or more progressively higher rating indicia. In some embodiments, the ratings indicia comprise stars (e.g., **4382-2**, FIG. **43V**). In some embodiments, the series of ratings indicia consists of five stars.

A finger gesture (e.g., **4384**, FIG. **43V**) by a user is detected on one or more of the ratings indicia, wherein the finger gesture contacts a last rating indicia immediately prior to breaking contact with the touch screen display (e.g., the third rating indicia in FIG. **43V**). In some embodiments, the finger gesture contacts the lowest rating indicia prior to contacting one or more of the progressively higher rating indicia. In some embodiments, the finger gesture is a swipe gesture.

A rating corresponding to the last rating indicia contacted by the finger gesture is used as input to a function or application in the device. For example, the three-star rating for the

song “Come Together” in FIG. **43V** may be used to sort this content versus other content in the device and/or to determine how often this content is heard when content is played in a random order (e.g., shuffle mode **4376**, FIG. **43R**).

In some embodiments, the rating corresponding to the last rating indicia contacted by the finger gesture is used to give a rating for an item of content that is playable with a content player application on the device. In some embodiments, the item of content is an item of music and the content player application is a music player application. In some embodiments, the item of content is a video and the content player application is a video player application.

In some embodiments, the rating corresponding to the last rating indicia contacted by the finger gesture is used to give a rating for content on a web page that is viewable with a browser application on the device.

A graphical user interface on a portable multifunction device with a touch screen display comprises a series of ratings indicia **4382** on the touch screen display. The ratings indicia comprise a lowest rating indicia and one or more progressively higher rating indicia. In response to detecting a finger gesture by a user on one or more of the ratings indicia, wherein the finger gesture contacts a last rating indicia immediately prior to breaking contact with the touch screen display, a rating corresponding to the last rating indicia contacted by the finger gesture is used as input to a function or an application in the device.

As illustrated in FIGS. **43BB-43DD**, an application may change modes in response to a change in orientation of the device, with the two modes differing by more than a mere change in display orientation.

In some embodiments, a portable multifunction device with a rectangular touch screen display, which includes a portrait view and a landscape view, detects the device in a first orientation.

While the device is in the first orientation, an application is displayed in a first mode on the touch screen display in a first view (e.g., a hierarchical list mode for selecting music as illustrated in FIG. **43A**, FIG. **43J**, FIG. **43Q**, FIG. **43R**, and FIG. **43BB**).

The device is detected in a second orientation. In some embodiments, the first orientation and the second orientation are detected based on an analysis of data from one or more accelerometers (e.g., **168**). In some embodiments, the first orientation is rotated substantially 90° from the second orientation (e.g., by rotation **4392**, FIG. **43BB** to FIG. **43CC**).

In response to detecting the device in the second orientation, the application is displayed in a second mode on the touch screen display in a second view (e.g., FIG. **43CC**).

The first mode of the application differs from the second mode of the application by more than a change in display orientation. The application displays distinct or additional information in one of the first and second modes relative to the other of the first and second modes.

In some embodiments, the first view is the portrait view (e.g., FIG. **43A**, FIG. **43J**, FIG. **43Q**, FIG. **43R**, or FIG. **43BB**) and the second view is the landscape view (e.g., FIG. **43CC**). In some embodiments, substantially vertical finger gestures on or near the touch screen display are used to navigate in the first mode and substantially horizontal finger gestures (e.g., swipe gesture **4399**, FIG. **43CC**) on or near the touch screen display are used to navigate in the second mode.

In some embodiments, the first view is the landscape view and the second view is the portrait view.

In some embodiments, the rectangular touch screen display has a long axis and a short axis; the first orientation comprises a substantially vertical orientation of the long axis;

the second orientation comprises a substantially vertical orientation of the short axis; the first view is the portrait view (e.g., UI 4300BB, FIG. 43BB); and the second view is the landscape view (e.g. UI 4300CC, FIG. 43CC).

In some embodiments, the application is a music player, the first mode is a hierarchical list mode for selecting music (e.g., FIG. 43A to more list, FIG. 43J, to albums list, FIG. 43Q, to album content list FIG. 43R, to content, FIG. 43S/43BB), the first view is the portrait view, the second mode is a cover flow mode for selecting albums (e.g., FIG. 43CC), and the second view is the landscape view. The cover flow mode and other image modes are described in U.S. Provisional Patent Application No. 60/843,832, "Techniques And Systems For Browsing Media Content," filed Sep. 11, 2006; U.S. patent application Ser. No. 11/519,460, "Media Manager With Integrated Browsers," filed Sep. 11, 2006; and U.S. Provisional Patent Application No. 60/878,746 "Electronic Device With Image Based Browsing," filed Jan. 5, 2007, which are hereby incorporated by reference in their entirety. In some embodiments, in response to detecting a finger gesture on an album cover (e.g., gesture 4388, FIG. 43CC) or on an information icon (e.g., 4389, FIG. 43CC), the album cover is flipped over and information about tracks on the album is displayed (FIG. 43DD).

In some embodiments, the application is an address book, the first mode is a list mode for displaying entries in the address book, the first view is the portrait view, the second mode is an image mode for displaying images associated with corresponding entries in the address book, and the second view is the landscape view.

In some embodiments, the application is a world clock, the first mode is a list mode for displaying a list of time zones, the first view is the portrait view, the second mode is a map mode for displaying one or more time zones in the list of time zones on a map, and the second view is the landscape view.

In some embodiments, the application is a calendar. In some embodiments, the application is a photo management application. In some embodiments, the application is a data entry application.

A graphical user interface on a portable multifunction device with a rectangular touch screen display with a portrait view and a landscape view comprises a first mode of an application that is displayed in the portrait view and a second mode of the application that is displayed in the landscape view. In response to detecting the device in a first orientation, the first mode of the application is displayed in the portrait view. In response to detecting the device in a second orientation, the second mode of the application is displayed in the landscape view. The first mode of the application differs from the second mode of the application by more than a change in display orientation.

Such mode changes based on device orientation make the device easier to use because the user does not have to navigate through one or more display screens to get to a desired second mode or remember how to perform such navigation. Rather, the user merely needs to change the orientation of the device.

Additional description of mode changes based on device orientation can be found in U.S. Provisional Patent Application No. 60/947,300, "Modal Change Based on Orientation of a Portable Multifunction Device," filed Jun. 29, 2007, and U.S. patent application Ser. No. 11/969,800, "Modal Change Based on Orientation of a Portable Multifunction Device," filed Jan. 4, 2008, the content of which is hereby incorporated by reference in its entirety.

FIGS. 44A-44J illustrate portrait-landscape rotation heuristics in accordance with some embodiments.

In some embodiments, information in some applications is automatically displayed in portrait view or landscape view in device 100 based on an analysis of data from the one or more accelerometers 168. A user gesture (e.g. 4402, FIG. 44B), however, can override the view that is automatically chosen based on the accelerometer data. In some embodiments, the override ends when a second gesture (e.g., 4404, FIG. 44H) is detected (as described in Example 1 and Example 2 below, as illustrated by FIGS. 44A-44E and 44G-44J). In some embodiments, the override ends when the device is placed in an orientation where the displayed view matches the view recommended automatically based on the accelerometer data (as described in Example 3 and Example 4 below, as illustrated by FIGS. 44A-44F). In some embodiments, the override ends after a predetermined time. In some embodiments, the override ends when the user changes applications or goes back to the menu screen (FIG. 4A or 4B). These override termination heuristics make the device easier to use because either a simple gesture is used to end the override or the override ends automatically based on predefined criteria.

Example 1

In some embodiments, a portable multifunction device with a rectangular touch screen display and one or more accelerometers displays information on the rectangular touch screen display in a portrait view (e.g., FIG. 44A) or a landscape view (e.g., FIG. 44B) based on an analysis of data received from the one or more accelerometers.

A first predetermined finger gesture (e.g., gesture 4402, FIG. 44B) is detected on or near the touch screen display while the information is displayed in a first view.

In response to detecting the first predetermined finger gesture, the information is displayed in a second view (e.g., FIG. 44C) and the display of information is locked in the second view, independent of the orientation of the device (e.g., the display is locked in portrait view in FIGS. 44C, 44D, 44E, and 44G). In some embodiments, the first view is the landscape view (e.g., FIG. 44B) and the second view is the portrait view (e.g., FIG. 44A). In some embodiments, the first view is the portrait view and the second view is the landscape view.

A second predetermined finger gesture is detected on or near the touch screen display while the display of information is locked in the second view (e.g., gesture 4404, FIG. 44H).

In response to detecting the second predetermined finger gesture, the display of information in the second view is unlocked. For example, the display is unlocked in FIGS. 44I and 44J, so a portrait view is displayed when the long axis of the device is substantially vertical (FIG. 44I) and a landscape view is displayed when the short axis of the device is substantially vertical (FIG. 44I).

In some embodiments, the first and second predetermined finger gestures are multifinger gestures. In some embodiments, the first and second predetermined finger gestures are multifinger twisting gestures (e.g., gesture 4402, FIG. 44B and gesture 4404, FIG. 44H). In some embodiments, the first and second predetermined finger gestures occur on the touch screen display.

Example 2

In some embodiments, a portable multifunction device with a rectangular touch screen display, wherein the rectangular touch screen display includes a portrait view and a landscape view, detects the device in a first orientation (e.g., FIG. 44A).

US 7,479,949 B2

85

Information is displayed on the touch screen display in a first view while the device is in the first orientation.

The device is detected in a second orientation (e.g., FIG. 44B).

In response to detecting the device in the second orientation, the information is displayed in a second view.

A first predetermined finger gesture (e.g., gesture 4402, FIG. 44B) is detected on or near the touch screen display while the information is displayed in the second view.

In response to detecting the first predetermined finger gesture, the information is displayed in the first view (e.g., FIG. 44C) and the display of information is locked in the first view (e.g., the display is locked in portrait view in FIGS. 44C, 44D, 44E, and 44G).

A second predetermined finger gesture is detected on or near the touch screen display while the display of information is locked in the first view (e.g., gesture 4404, FIG. 44H).

In response to detecting the second predetermined finger gesture, the display of information in the first view is unlocked. For example, the display is unlocked in FIGS. 44I and 44J, so a portrait view is displayed when the long axis of the device is substantially vertical (FIG. 44J) and a landscape view is displayed when the short axis of the device is substantially vertical (FIG. 44I).

In some embodiments, the first view is the landscape view and the second view is the portrait view. In some embodiments, the first view is the portrait view (e.g., FIG. 44A) and the second view is the landscape view (e.g., FIG. 44B).

In some embodiments, the first and second predetermined finger gestures are multifinger gestures. In some embodiments, the first and second predetermined finger gestures are multifinger twisting gestures (e.g., gesture 4402, FIG. 44B and gesture 4404, FIG. 44H). In some embodiments, the first and second predetermined finger gestures occur on the touch screen display.

Example 3

In some embodiments, a portable multifunction device with a rectangular touch screen display and one or more accelerometers displays information on the rectangular touch screen display in a portrait view (e.g., FIG. 44A) or a landscape view (e.g., FIG. 44B) based on an analysis of data received from the one or more accelerometers.

A predetermined finger gesture (e.g., gesture 4402, FIG. 44B) is detected on or near the touch screen display while the information is displayed in a first view. In some embodiments, the predetermined finger gesture is a multifinger twisting gesture. In some embodiments, the predetermined finger gesture occurs on the touch screen display.

In response to detecting the predetermined finger gesture, the information is displayed in a second view (e.g., FIG. 44C) and the display of information is locked in the second view.

The display of information in the second view is unlocked when the device is placed in an orientation where the second view is displayed based on an analysis of data received from the one or more accelerometers (e.g., FIG. 44E). For example, the display is unlocked in FIGS. 44E and 44F, so a portrait view is displayed when the long axis of the device is substantially vertical (FIG. 44E) and a landscape view is displayed when the short axis of the device is substantially vertical (FIG. 44F).

In some embodiments, the first view is the landscape view (e.g., FIG. 44B) and the second view is the portrait view (e.g., FIG. 44A). In some embodiments, the first view is the portrait view and the second view is the landscape view.

86

Example 4

In some embodiments, a portable multifunction device with a rectangular touch screen display, wherein the rectangular touch screen display includes a portrait view and a landscape view, detects the device in a first orientation.

Information is displayed on the touch screen display in a first view while the device is in the first orientation (e.g., FIG. 44A).

The device is detected in a second orientation.

In response to detecting the device in the second orientation, the information is displayed in a second view (e.g., FIG. 44B).

A predetermined finger gesture (e.g., gesture 4402, FIG. 44B) is detected on or near the touch screen display while the information is displayed in the second view. In some embodiments, the predetermined finger gesture is a multifinger gesture. In some embodiments, the predetermined finger gesture occurs on the touch screen display.

In response to detecting the predetermined finger gesture, the information is displayed in the first view (e.g., FIG. 44C) and the display of information is locked in the first view.

The display of information in the first view is unlocked when the device is returned to substantially the first orientation (e.g., FIG. 44E). For example, the display is unlocked in FIGS. 44E and 44F, so a portrait view is displayed when the long axis of the device is substantially vertical (FIG. 44E) and a landscape view is displayed when the short axis of the device is substantially vertical (FIG. 44F).

In some embodiments, the first view is the landscape view and the second view is the portrait view. In some embodiments, the first view is the portrait view (e.g., FIG. 44A) and the second view is the landscape view (e.g., FIG. 44B).

In some embodiments, the first orientation and the second orientation are detected based on an analysis of data from one or more accelerometers. In some embodiments, the first orientation is rotated 90° from the second orientation.

Additional description of portrait-landscape rotation heuristics can be found in U.S. Provisional Patent Application No. 60/947,132, "Portrait-Landscape Rotation Heuristics for a Portable Multifunction Device," filed Jun. 29, 2007, and U.S. patent application Ser. No. 11/960,671, "Portrait-Landscape Rotation Heuristics for a Portable Multifunction Device," filed Dec. 19, 2007, the content of which is hereby incorporated by reference in its entirety.

Given the limited area on a touch screen display, one challenge is how to present various amount of information in a highly intuitive manner. FIGS. 45A-45G are graphical user interfaces illustrating an adaptive approach for presenting information on the touch screen display in accordance with some embodiments. For illustrative purpose, the video folder in the music and video player module is shown. But it will be apparent to one skilled in the art that this approach is readily applicable to many other occasions with little or no modification (e.g., for displaying notification information for missed communications as described with respect to FIGS. 53A-53D below).

For a given total number of user interface objects, the device may display information about at least two individual user interface objects if the total number meets a first predefined condition. In some embodiments, the device may display information about all the user interface objects on the touch screen display.

In some embodiments, the first predefined condition is that the total number of user interface objects is equal to or less than a predetermined threshold. In some other embodiments, the first predefined condition is that the total number of user

interface objects is equal to or less than a maximum number of user interface objects that can be simultaneously displayed.

As shown in FIG. 45A, the video folder has only four objects including two movies and two music videos. Since information about the four objects can fit into the touch screen display, a hierarchical approach of grouping the movies into one sub-folder and the music videos into another sub-folder is probably less preferred. Rather, the four objects are shown in a flat view with two labels 4510 and 4515 indicating the two media types.

In some embodiments, the device may present the information in a flat view if the total number of user interface objects is slightly more than what can fit into the display. A user can easily scroll the flat view up or down to see the hidden portion using a substantially vertical finger swipe gesture.

If the total number of user interface objects meets a second predefined condition, the device then divides the user interface objects into at least a first group of user interface objects and a second group of user interface objects. A first group icon is displayed for the first group of user interface objects. For the second group of user interface objects, at least one group member is shown on the touch screen display.

In some embodiments, the second predefined condition is that the total number of the first group of user interface objects is equal to or less than a predetermined threshold and the total number of the second group of user interface objects is greater than the predetermined threshold.

FIG. 45B depicts that there are 30 music videos in the music video folder in total by four different artists or groups, 10 by the Beatles, 18 by U2, one by Bryan Adams, and one by Santana. Given the size of the touch screen display, a flat view of all the 30 music videos is probably less convenient because this may require multiple finger swipe gestures to scan through all the objects. Moreover, it is less intuitive to tell the artist for each individual music video. On the other hand, it is also inconvenient if the music videos by Santana and Bryan Adams each have their own sub-folder because a user has to open the sub-folder to see the music video's title while there is still blank space on the touch screen display.

Rather, FIG. 45B is a hybrid view of information about the 30 music videos. A group icon 4520 is used for representing the Beatles' works and a group icon 4525 for U2's works. The group icon indicates the number of music videos in that sub-folder. A user can simply finger tap a group icon, e.g., 4525, to learn more information about the 18 U2 music videos (FIG. 45C). The other two music videos are displayed as two separate items, each including information about the artist and the music video's title.

If the total number of user interface objects meets a third predefined condition, the device divides the user interface objects into at least a third group of user interface objects and a fourth group of user interface objects. A third group icon is displayed for the third group of user interface objects. A fourth group icon is displayed for the fourth group of user interface objects.

In some embodiments, the third predefined condition is that the total number of the third group of user interface objects is greater than a predetermined threshold and the total number of the fourth group of user interface objects is greater than the predetermined threshold. In some embodiments, as shown in FIG. 45D, a group icon (e.g., 4530 and 4535) is displayed on the touch screen display even if the corresponding group is empty.

In some other embodiments, as shown in FIG. 45E, only a group icon (e.g., 4540 and 4545) whose associated group is not empty is displayed on the touch screen display. Each of

the two groups has a sufficient number of objects that cannot fit into the touch screen display.

In some embodiments, the aforementioned information classification and presentation approach is an automatic and recursive process. Upon detecting a user selection of a respective group icon corresponding to the first, third or fourth groups of user interface objects, the device checks whether the user-selected group of user interface objects meet one of the first, second or third predefined conditions and then operates accordingly.

For example, in response to a user selection of the movies icon 4540, a hybrid view of the movie information is displayed in FIG. 45F. Like the hybrid view shown in FIG. 45B, three movies are shown as individual items with detailed information and the other 17 movies are broken into two sub-groups, each having its own group icon Cartoon (6) 4550 and Foreign (11) 4555.

In some embodiments, the user interface objects may be grouped by information type. For example, the objects in FIG. 45A are broken into movie and music video. In some other embodiments, the user interface objects may be grouped by information source. For example, the objects in FIG. 45D are broken into TV show and Podcast.

In some embodiments, a unique group identifier is assigned to each group of user interface objects in a flat view. For example, in FIG. 45G the group labels 4510 and 4515 are exemplary group identifiers. When the user scrolls upward the list of user interface objects, the group identifier at the top of the list (e.g., movies 4510) does not move until the last item in the movie group, i.e., The Shawshank Redemption, moves out of the screen (analogous to the scrolling described above with respect to FIGS. 43E, 43F, 43H, and 43I). At this time, the movies label 4510 is then replaced by the music videos label 4515.

Additional description of adaptive user interface displays can be found in U.S. Provisional Patent Application No. 60/937,992, "Portable Multifunction Device, Method, and Graphical User Interface for Displaying User Interface Objects Adaptively," filed Jun. 29, 2007, and U.S. patent application Ser. No. 11/961,760, "Portable Multifunction Device, Method, and Graphical User Interface for Displaying User Interface Objects Adaptively," filed Dec. 20, 2007, the content of which is hereby incorporated by reference in its entirety.

FIGS. 46A-46C illustrate digital artwork created for a content file based on metadata associated with the content file in accordance with some embodiments.

Additional description of such artwork can be found in U.S. Provisional Patent Application No. 60/883,818, "Creating Digital Artwork Based On Content File Metadata," filed Jan. 7, 2007, and U.S. patent application Ser. No. 11/960,674, "Creating Digital Artwork Based On Content File Metadata," filed Dec. 19, 2007, the content of which is hereby incorporated by reference in its entirety.

FIGS. 47A-47E illustrate exemplary methods for moving a slider icon in accordance with some embodiments. Such slider icons have many uses, such as content progress bars (e.g., FIGS. 47A and 47B, and 2310 FIG. 23B), volume and other level controls (e.g. 2324 FIG. 23D), and switches (e.g., FIGS. 47C-47E).

In some embodiments, a portable multifunction device (e.g., device 100) with a touch screen display (e.g., display 112) detects a finger contact (e.g., finger contact 4706, FIG. 47A, or 4734, FIG. 47C) with a predefined area (e.g., area 4702, FIG. 47A, or 4730, FIG. 47C) on the touch screen display. The predefined area includes an icon (e.g., icon 4732, FIG. 47C) that is configured to slide in a first direction in the

predefined area on the touch screen display. In some embodiments, the predefined area comprises a slider bar (e.g., slider bar **4704**, FIG. **47A**). In some embodiments, the first direction is a horizontal direction on the touch screen display. In some embodiments, the first direction is a vertical direction on the touch screen display.

In some embodiments, the icon is moved to the finger contact upon detecting the finger contact with the predefined area. For example, slider bar **4704** moves to the finger contact **4706** upon detecting the finger contact **4706**, as shown in FIG. **47A**.

Movement of the finger contact is detected on the touch screen display from the predefined area to a location outside the predefined area. The movement of the finger contact on the touch screen display has a component parallel to the first direction and a component perpendicular to the first direction.

For example, in FIG. **47B**, movements **4710**, **4712**, and **4714** of the finger contact from finger contact location **4706** to finger contact location **4708** all have a component Adx **4716** parallel to the direction of motion of the slider bar **4704**. Similarly, movements **4710**, **4712**, and **4714** all have a component perpendicular to the direction of motion of the slider bar **4704** (not shown).

In another example, in FIG. **47D**, movements **4738**, **4740**, and **4742** of the finger contact from finger contact location **4734** to finger contact location **4736** all have a component Adx **4744** parallel to the direction of motion of the slider icon **4732**. Similarly, movements **4738**, **4740**, and **4742** all have a component perpendicular to the direction of motion of the slider icon **4732** (not shown). Additional movement of the finger contact from location **4736** to location **4738** has an additional component Adx **4746** (FIG. **47E**) parallel to the direction of motion of the slider icon **4732**.

The icon is slid in the predefined area in accordance with the component of the movement of the finger contact that is parallel to the first direction. In some embodiments, sliding of the icon is ceased if a break in the finger contact with the touch screen display is detected.

For example, in FIG. **47B**, the slider bar **4704** moves by a distance Δd_x equal to the parallel component Δd_x **4716** of movements **4710**, **4712**, and **4714**. In another example, in FIG. **47D** the slider icon **4732** moves by a distance Adx equal to the parallel component Δd_x **4744** of movements **4738**, **4740**, and **4742**. In FIG. **47E**, the slider icon **4732** moves by an additional distance Δd_x **4746** corresponding to additional movement of the finger contact from location **4736** to **4738**.

These methods for moving a slider icon permit a user to precisely position the slider icon without having the user's view of the slider icon obstructed by the user's finger.

Additional description of positioning a slider icon can be found in U.S. Provisional Patent Application No. 60/947,304, "Positioning a Slider Icon on a Portable Multifunction Device," filed Jun. 29, 2007, and U.S. patent application Ser. No. 11/968,064, "Positioning a Slider Icon on a Portable Multifunction Device," filed Dec. 31, 2007, the content of which is hereby incorporated by reference in its entirety.

Notes Application

FIGS. **48A-48C** illustrate an exemplary user interface for managing, displaying, and creating notes in accordance with some embodiments. In some embodiments, user interface **4800A** (FIG. **48A**) includes the following elements, or a subset or superset thereof:

- 402**, **404**, and **406**, as described above;
- The number **4802** of existing notes;
- Titles **4810** of existing notes;
- Date **4812** and/or time of the note; and

Additional information icon **4814** that when activated (e.g., by a finger tap on the icon) initiates transition to the corresponding note (e.g., UI **4800B**, FIG. **48B**).

In some embodiments, detection of a user gesture **4816** anywhere in a row corresponding to a note initiates transition to the corresponding note (e.g., UI **4800B**, FIG. **48B**).

In some embodiments, user interface **4800B** (FIG. **48B**) includes the following elements, or a subset or superset thereof:

402, **404**, and **406**, as described above;

Notes icon **4820** that when activated (e.g., by a finger tap on the icon) initiates display of UI **4800A**;

title **4810-3** of the note;

a notepad **4824** for displaying text;

Previous note icon **4832** that when activated (e.g., by a finger tap on the icon) initiates display of the previous note;

Create email icon **4834** that when activated (e.g., by a finger tap on the icon) initiates transfer to the email application **140** and display of a UI for creating an email message (e.g., UI **3400A**, FIG. **34A**);

Trash icon **4836** that when activated (e.g., by a finger tap on the icon) initiates display of a UI for deleting the note; and

Next note icon **4838** that when activated (e.g., by a finger tap on the icon) initiates display of the next note.

In some embodiments, detection of a user gesture **4826** anywhere on the notepad **4824** initiates display of a contextual keyboard (e.g., UI **4800C**, FIG. **48C**) for entering text in the notepad **4824**.

In some embodiments, when a contextual keyboard is displayed, detection of a user gesture on text in the notepad **4824** initiates display of an insertion point magnifier **4830**, as described above with respect to FIGS. **6I-6K**.

In some embodiments, word suggestion techniques and user interfaces are used to make text entry easier. In some embodiments, a recommended word is put in the space bar (e.g., the recommended word "dinner" is in the space bar in FIG. **6J**) and detecting user contact with the space bar initiates acceptance of the recommended word. Additional description of word suggestion can be found in U.S. patent application Ser. No. 11/620,641, "Method And System For Providing Word Recommendations For Text Input," filed Jan. 5, 2007, and U.S. patent application Ser. No. 11/620,642, "Method, System, And Graphical User Interface For Providing Word Recommendations," filed Jan. 5, 2007, the contents of which are hereby incorporated by reference in their entirety.

Calendar

FIGS. **49A-49N** illustrate exemplary user interfaces for a calendar in accordance with some embodiments. Additional description of calendars can be found in U.S. Provisional Patent Application No. 60/883,820, "System And Method For Viewing And Managing Calendar Entries," filed Jan. 7, 2007, and U.S. patent application Ser. No. 11/969,786, "System and Method for Viewing And Managing Calendar Entries," filed Jan. 4, 2008, the content of which is hereby incorporated by reference in its entirety.

In some embodiments, the use of date and time wheels simplifies the input of date and time information using finger gestures on a touch screen display (e.g. FIGS. **49F**, **49G**, **49J**, and **50B**).

In some embodiments, a portable multifunction device (e.g., device **100**) with a touch screen display (e.g., display **112**) displays: a month column (e.g., column **4990**, FIG. **49J**) comprising a sequence of month identifiers; a date column (e.g., column **4960**) comprising a sequence of date numbers; and a selection row (e.g., row **4968**) that intersects the month

US 7,479,949 B2

91

column and the date column and contains a single month identifier (e.g., “December” **4972**) and a single date number (e.g., “1” **4874**). In some embodiments, the month column, date column and selection row are simultaneously displayed.

A gesture (e.g., gesture **4992**) is detected on the month column. In some embodiments, the gesture on the month column is a finger gesture. In some embodiments, the gesture on the month column is a substantially vertical swipe. In some embodiments, the gesture on the month column is a substantially vertical gesture on or near the month column.

In response to detecting the gesture on the month column, the month identifiers in the month column are scrolled without scrolling the date numbers in the date column. In some embodiments, the month identifiers form a continuous loop in the month column.

A gesture (e.g., gesture **4982**) is detected on the date column. In some embodiments, the gesture on the date column is a finger gesture. In some embodiments, the gesture on the date column is a substantially vertical swipe. In some embodiments, the gesture on the date column is a substantially vertical gesture on or near the date column.

In response to detecting the gesture on the date column, the date numbers in the date column are scrolled without scrolling the month identifiers in the month column. In some embodiments, the date numbers form a continuous loop in the date column.

The single month identifier and the single date number in the selection row after scrolling the month identifiers and the date numbers, respectively, are used as date input for a function or application (e.g., calendar **148**) on the multifunction device.

A graphical user interface on a portable multifunction device with a touch screen display comprises: a month column comprising a sequence of month identifiers; a date column comprising a sequence of date numbers; and a selection row that intersects the month column and the date column and contains a single month identifier and a single date number. In response to detecting a gesture on the month column, the month identifiers in the month column are scrolled without scrolling the date numbers in the date column. In response to detecting a gesture on the date column, the date numbers in the date column are scrolled without scrolling the month identifiers in the month column. The single month identifier and the single date number in the selection row after scrolling the month identifiers and the date numbers, respectively, are used as date input for a function or application on the multifunction device.

Additional description of inputting date and time information can be found in U.S. Provisional Patent Application No. 60/947,146, “System, Method, and Graphical User Interface for Inputting Date and Time Information on a Portable Multifunction Device,” filed Jun. 29, 2007, and U.S. patent application Ser. No. 11/968,051, “System, Method, and Graphical User Interface for Inputting Date and Time Information on a Portable Multifunction Device,” filed Dec. 31, 2007, the content of which is hereby incorporated by reference in its entirety.

Clock

FIGS. **50A-50I** illustrate exemplary user interfaces for a clock in accordance with some embodiments. In some embodiments, user interface **5000A** includes the following elements, or a subset or superset thereof:

402, **404**, and **406**, as described above;

Names of locations **5010**;

Clock icons **5012** and time and day information **5014** for each location **5010**;

92

World clock icon **5020** that when activated in a UI other than UI **5000A** (e.g., by a finger tap on the icon) initiates display of a world clock (e.g., UI **5000A**);

Alarm icon **5022** that when activated (e.g., by a finger tap on the icon) initiates display of an alarm clock (e.g., UI **5000B**, FIG. **50B** or UI **500C**, FIG. **5C**);

Stopwatch icon **5024** that when activated (e.g., by a finger tap on the icon) initiates display of a stopwatch (e.g., UI **5000E**, FIG. **50E**); and

Timer icon **5026** that when activated (e.g., by a finger tap on the icon) initiates display of a timer (e.g., UI **5000H**, FIG. **50H**).

FIG. **50B** illustrates an exemplary user interface for setting an alarm clock in accordance with some embodiments. In some embodiments, user interface **5000B** includes the following elements, or a subset or superset thereof:

402, **404**, and **406**, as described above;

alarm frequency setting icons **5036**, **5038**, **5040**, and **5042** for setting the frequency of the alarm;

sound icon **5044** and beep icon **5046** for setting the sound associated with the alarm;

additional setting options icon **5048** that when activated (e.g., by a finger tap on the icon) initiates display of a user interface for specifying additional alarm settings; wheels of time **5052** for displaying and setting the alarm time;

enter icon **5060** for entering the alarm time displayed on the wheel of time **5052**;

cancel icon **5032** that when activated (e.g., by a finger tap on the icon) returns the device to the previous user interface; and

done icon **5034** that when activated (e.g., by a finger tap on the icon) saves the alarm settings specified by the user and returns the device to the previous user interface.

In some embodiments, the wheels of time **5052** are displayed in response to detection of a finger contact **5050**. The alarm time displayed on the wheels of time **5052** may be modified in response to detection of a substantially vertical swipe **5054** to change the hour setting, a substantially vertical swipe **5056** to change the minutes setting, and/or a substantially vertical swipe (e.g., **4988**, FIG. **49F** or **5058**, FIG. **50B**) to change the AM/PM setting. In some embodiments, in response to detection of a finger contact on the enter icon **5060**, the alarm time displayed on the wheels of time **5052** is saved and display of the wheels of time **5052** is ceased.

In some embodiments, the use of time wheels simplifies the input of time information using finger gestures on a touch screen display.

In some embodiments, a portable multifunction device (e.g., device **100**) with a touch screen display (e.g., display **112**) displays: an hour column (e.g., column **5062**, FIG. **50B**) comprising a sequence of hour numbers; a minute column (e.g., column **5064**, FIG. **50B**) comprising a sequence of minute numbers; and a selection row (e.g., row **5068**, FIG. **50B**) that intersects the hour column and the minute column and contains a single hour number (e.g., “6” **5076**) and a single minute number (e.g., “25” **5078**).

A gesture (e.g., gesture **5054**) is detected on the hour column. In some embodiments, the gesture on the hour column is a finger gesture. In some embodiments, the gesture on the hour column is a substantially vertical swipe.

In response to detecting the gesture on the hour column, the hour numbers in the hour column are scrolled without scrolling the minute numbers in the minute column. In some embodiments, the hour numbers form a continuous loop in the hour column.

A gesture (e.g., gesture **5056**) is detected on the minute column. In some embodiments, the gesture on the minute column is a finger gesture. In some embodiments, the gesture on the minute column is a substantially vertical swipe.

In response to detecting the gesture on the minute column, the minute numbers in the minute column are scrolled without scrolling the hour numbers in the hour column. In some embodiments, the minute numbers form a continuous loop in the minute column.

The single hour number and the single minute number in the selection row after scrolling the hour numbers and the date numbers, respectively, are used as time input for a function or application on the multifunction device.

A graphical user interface on a portable multifunction device with a touch screen display comprises: a hour column comprising a sequence of hour numbers; a minute column comprising a sequence of minute numbers; and a selection row that intersects the hour column and the minute column and contains a single hour number and a single minute number. In response to detecting a gesture on the hour column, the hour numbers in the hour column are scrolled without scrolling the minute numbers in the minute column. In response to detecting a gesture on the minute column, the minute numbers in the minute column are scrolled without scrolling the hour numbers in the hour column. The single hour number and the single minute number in the selection row after scrolling the hour numbers and the minute numbers, respectively, are used as time input for a function or application on the multifunction device.

In some embodiments, the date and time wheels are combined to make it easy to set a date and time with finger gestures. For example, FIG. **49F** shows date and time wheels with a single month and date column, an hour column, a minutes column, and an AM/PM column for inputting date and time information for calendar events.

In some embodiments, a portable multifunction device (e.g., device **100**) with a touch screen display (e.g., display **112**) displays a date column (e.g., column **4960**, FIG. **49F**) comprising a sequence of dates, an hour column (e.g., column **4962**) comprising a sequence of hour numbers; and a minute column (e.g., column **4964**) comprising a sequence of minute numbers. A respective date in the sequence of dates comprises a name of a month (e.g., "Dec." **4972**) and a date number (e.g., "18" **4974**) of a day within the month. In some embodiments, the respective date in the sequence of dates further comprises a day of the week (e.g., "Mon." **4970**) corresponding to the name of the month and the date number of the day within the month.

The device also displays a selection row (e.g., row **4968**) that intersects the date column, the hour column, and the minute column and contains a single date (e.g., **4970**, **4972**, and **4974**), a single hour number (e.g., "12" **4976**), and a single minute number (e.g., "35" **4978**).

A gesture (e.g., gesture **4982**) on the date column is detected. In response to detecting the gesture on the date column, the dates in the date column are scrolled without scrolling the hour numbers in the hour column or the minute numbers in the minute column. In some embodiments, the gesture on the date column is a finger gesture. In some embodiments, the gesture on the date column is a substantially vertical swipe.

A gesture (e.g., gesture **4984**) on the hour column is detected. In response to detecting the gesture on the hour column, the hour numbers in the hour column are scrolled without scrolling the dates in the date column or the minute numbers in the minute column. In some embodiments, the gesture on the hour column is a finger gesture. In some

embodiments, the gesture on the hour column is a substantially vertical swipe. In some embodiments, the hour numbers form a continuous loop in the hour column.

A gesture (e.g., gesture **4986**) on the minute column is detected. In response to detecting the gesture on the minute column, the minute numbers in the minute column are scrolled without scrolling the dates in the date column or the hour numbers in the hour column. In some embodiments, the gesture on the minute column is a finger gesture. In some embodiments, the gesture on the minute column is a substantially vertical swipe. In some embodiments, the minute numbers form a continuous loop in the minute column.

The single date, the single hour number, and the single minute number in the selection row after scrolling the dates, the hour numbers and the minute numbers, respectively, are used as time input for a function or application (e.g., calendar **148**) on the multifunction device.

FIG. **50D** illustrates another exemplary user interface for setting an alarm in accordance with some embodiments

For the stopwatch (FIGS. **50E-50G**), in response to activation of a start icon **5001** (FIG. **50E**), an elapsed time **5003** (FIG. **50F**) is displayed. In response to each activation of a lap icon **5005** (FIG. **50F**), corresponding lap times **5007** (FIG. **50G**) are displayed.

For the timer (FIGS. **50H-50I**), in response to activation of a start icon **5009** (FIG. **50H**), a remaining time **5011** (FIG. **50I**) is displayed.

Widget Creation Application

FIGS. **51A-51B** illustrate exemplary user interfaces for creating a widget in accordance with some embodiments.

Additional description of user created widgets can be found in U.S. Provisional Patent Application Nos. 60/883, 805, "Web Clip Widgets On A Portable Multifunction Device," filed Jan. 7, 2007, and 60/946,712, "Web Clip Widgets on a Portable Multifunction Device," filed Jun. 27, 2007, and U.S. patent application Ser. No. 11/850,011, "Web Clip Widgets On a Portable Multifunction Device," filed Sep. 4, 2007, the contents of which are hereby incorporated by reference in their entirety.

Map Application

FIGS. **52A-52H** illustrate exemplary user interfaces for a map application in accordance with some embodiments.

Upon detecting a user selection of the map icon **154** in FIG. **4B**, the device renders the user interface **5200A** on its touch screen display. The user interface **5200A** includes a text box **5202** for a user to enter search term(s) and a bookmark icon **5204**. A default map is displayed on the touch screen display.

In some embodiments, the default map is a large map (e.g., the continental portion of the United States in FIG. **52A**). In some other embodiments, the default map is the last map displayed when the map module was previously used. In some other embodiments, the default map is a map of the geographical area that the device is currently located. To generate this map, data about the current location of the device is retrieved from a remote data center or the GPS module built into the device. This data is then submitted to a remote map server to generate a map of the local area.

In some embodiments, the device, periodically or not, generates a new version of the local map to replace the old version. When the user activates the map module, the latest version of the local map is displayed as the default map.

The user interface **5200A** also includes several application icons. For example, a user selection of the direction icon **5212** replaces the user interface **5200A** with a new interface through which the user can enter a begin address and an end address. For a given pair of addresses, the device can display

information about the driving direction from the begin address to the end address and also the return driving directions.

A map search result may be displayed in one of three different views: (i) map view **5206**, (ii) satellite view **5208**, and (iii) list view **5210**. As shown in FIG. **52C**, the map view **5206** displays a geographical map covering the map search result with one or more clickable icons corresponding to the entities matching a user-provided search query within the geographical area. The satellite view **5210** replaces the geographical map with a satellite image of the same geographical area. The list view **5210** arranges the matching entities in the map search result into a list and displays the list in a primarily text format.

As shown in FIG. **52B**, a user selection of the text box **5202** replaces the bookmark icon **5204** with a delete icon **5214**. A soft keyboard **5216** appears in the lower portion of the touch screen display. The user can enter a search query by finger taps on the key icons. For example, the user enters the term "Sunnyvale, Calif." into the text field and then hits the search icon at the lower right corner of the keyboard.

FIG. **52C** depicts a graphical user interface **5200C** illustrating the map search result associated with the search query "Sunnyvale, Calif.". Note that the map search result is displayed in a map view. There is an arrow in the central region of map pointing to the City of Sunnyvale.

In some embodiments, a user can move the map on the touch screen display by a single stationary finger contact with the map followed by finger movements on the touch screen display. Through this operation, the user can view the neighboring areas not shown initially on the touch screen display. Various finger gestures discussed above in connection with FIG. **39C** can be used here to manipulate the map. For example, a finger de-pinching gesture zooms into the map to display more details of the local geographical information. A finger pinching gesture zooms out of the map to provide a map of a broader area including the area covered by the map.

FIG. **52D** depicts a graphical user interface **5200D** illustrating the map search result associated with the query "Starbucks". The map search result includes the locations of Starbucks Coffee stores in the Sunnyvale area, each clickable balloon on the map representing one store in the area. One of the stores at approximately the center of the map is highlighted by a larger label icon **5217**. The label icon **5217** includes an arrow icon **5218**.

FIG. **52E** depicts a graphical user interface **5200E** illustrating the details of one Starbucks store, which are displayed in response to a user selection of the arrow icon **5218** in FIG. **52D**. A local map **5220** provides more details about this Starbucks store. There is a phone call icon **5222** including the store's phone number. User selection of the phone call icon (e.g., by a finger tap on the icon) initiates a phone call to the store and the user interface **5200E** is replaced with a phone call user interface (e.g., **3000A** in FIG. **30A**).

FIG. **52F** depicts a graphical user interface **5200F** that is displayed in response to a user selection of the local map **5220**. An enlarged version of the map **5224** occupies most of the touch screen display. In addition to the phone call icon **5222**, there may also be a URL link icon **5250** to the store's homepage. User selection of the URL link icon **5250** (e.g., by a finger tap on the icon) may initiate display of the corresponding web page in the browser application **147**.

FIG. **52G** depicts a graphical user interface **5200G** that is displayed in response to a user selection of the list view icon in FIG. **52D**. A user selection **5226** of a store address in the list brings the user back to interface **5200D** shown in FIG. **52D**. The label icon **5217** is next to the user-selected store in the

list. A user selection **5228** of the more detail icon brings back the user interface **5200E** shown in FIG. **52E** for the corresponding store.

FIG. **52H** depicts a graphical user interface **5200H** with a list of user-specified address bookmarks, which is displayed in response to a user selection of the bookmark icon **5204** in FIG. **52A**. A finger tap on one bookmark item (e.g., Moscone West) causes the current user interface to be replaced by a map covering the bookmark item. For example, a user selection of Colosseum causes the device to display a map or satellite image of the area in Rome that includes the Colosseum.

Additional description of providing maps and directions can be found in U.S. Provisional Patent Application No. 60/936,725, "Portable Multifunction Device, Method, and Graphical User Interface for Providing Maps and Directions," filed Jun. 22, 2007, and U.S. patent application Ser. No. 11/969,211, "Portable Multifunction Device, Method, and Graphical User Interface for Providing Maps and Directions," filed Jan. 3, 2008, the content of which is hereby incorporated by reference in its entirety.

General Touch Screen/System UI Features

Start Up/Shut Down/Wake Up

FIGS. **53A-53D** illustrate exemplary user interfaces for displaying notification information for missed communications in accordance with some embodiments.

Additional description of displaying notification information for missed communications can be found in U.S. Provisional Patent Application No. 60/883,804, "System And Method For Displaying Communication Notifications," filed Jan. 7, 2007 and U.S. patent application Ser. No. 11/770,718, "Portable Multifunction Device, Method, and Graphical User Interface for Managing Communications Received While in a Locked State," filed Jun. 28, 2007, the contents of which are hereby incorporated by reference in their entirety.

FIG. **54** illustrates a method for silencing a portable device in accordance with some embodiments.

Additional description of methods for silencing a portable device can be found in U.S. Provisional Patent Application No. 60/883,802, "Portable Electronic Device With Alert Silencing," filed Jan. 7, 2007 and U.S. patent application Ser. No. 11/770,727, "Portable Electronic Device with Alert Silencing," filed Jun. 28, 2007, the contents of which are hereby incorporated by reference in their entirety.

FIGS. **55A-55D** illustrate a method for turning off a portable device in accordance with some embodiments.

Additional description of methods for turning off a portable device can be found in U.S. Provisional Patent Application No. 60/883,786, "Power-Off Methods For Portable Electronic Devices," filed Jan. 6, 2007, and U.S. patent application Ser. No. 11/770,722, "Power-Off Methods For Portable Electronic Devices," filed Jun. 28, 2007, the contents of which are hereby incorporated by reference in their entirety.

Cursor

FIGS. **56A-56L** illustrate exemplary methods for determining a cursor position in accordance with some embodiments.

In some embodiments, as shown in FIG. **56A**, the touch screen display displays multiple user interface objects **5602-5608**. Exemplary user interface objects include an open icon, a close icon, a delete icon, an exit icon, or soft keyboard key icons. Some of these icons may be deployed within a small region on the touch screen display such that one icon is adjacent to another icon.

When there is a finger contact with the touch screen display, unlike the conventional mouse click, the finger has a certain contact area (e.g., **5610** in FIG. **56A**) on the touch screen display. In some embodiments, a cursor position corresponding to the finger's contact area **5610** with the touch screen display needs to be determined. A user interface object at or near the cursor position may then be activated to perform a predefined operation.

As shown in FIGS. **59A-59D**, a finger contact with the touch screen display (e.g., a finger tap) is a process involving multiple actions including the finger approaching the display, the finger being in contact with the display, and the finger leaving the display. During this process, the finger's contact area increases from zero to a maximum contact area and then reduces to zero. In some embodiments, for a stationary finger contact with the display, the detected contact area **5610** corresponds to the maximum contact area of the finger with the display during a time period corresponding to the stationary contact.

A first position associated with the contact area **5610** is determined. As will be explained below, the first position may or may not be the cursor position corresponding to the finger contact. But the first position will be used to determine the cursor position.

In some embodiments, as shown in FIG. **56B**, the first position P_1 is the centroid of the contact area **5610**.

In some other embodiments, when a finger is in physical contact with the touch screen display, the finger's pressure on the display is detected, which varies from one position to another position. Sometimes, the position at which a user applies the maximum pressure may not be the centroid P_1 of the contact area. But the maximum pressure position P_2 is probably closer to the user's target. There is often a fixed distance between the centroid of the contact area and the corresponding maximum pressure's position. As shown in FIG. **56H**, the contact area **5610** is elliptical with a major axis, a minor axis perpendicular to the major axis, and a centroid P_1 . Given that there is a substantially constant offset $\Delta d'$ from the centroid P_1 to the maximum pressure position P_2 along the major axis, the first position or the maximum pressure position P_2 can be determined from P_1 and $\Delta d'$.

A cursor position P associated with the finger contact is determined based on one or more parameters, including the location of the first position, i.e., P_1 in FIG. **56B** or P_2 in FIG. **56H**, one or more distances between the first position and one or more of the user interface objects near the first position, and, in some embodiments, one or more activation susceptibility numbers associated with the user interface objects (e.g., W_1 - W_4 in FIG. **56C** or FIG. **56I**).

In some embodiments, as shown in FIGS. **56C** and **56I**, the distance between the first position (P_1 in FIG. **56C** or P_2 in FIG. **56I**) and a respective user interface object (**5602**, **5604**, **5606**, or **5608**) is the distance between the first position and a point on the user interface object that is closest to the first position.

In some other embodiments, as shown in FIGS. **56D** and **56J**, the distance between the first position (P_1 in FIG. **56D** or P_2 in FIG. **56L**) and a user interface object (**5602**, **5604**, **5606**, or **5608**) is the distance between the first position and the center of the user interface object.

In some embodiments, the offset between the cursor position and the first position (e.g., Δd in FIGS. **56E** and **56F**) is given by the formula as follows:

$$\Delta \vec{d} = \sum_i \Delta \vec{d}_i = \sum_i \frac{W_i}{d_i^n} \vec{u}_i,$$

where:

$\Delta \vec{d}$ is the offset between the cursor position P and the first position P_1 ,

$\Delta \vec{d}_i$ is an offset component associated with a user interface object I along the direction between the first position and the user interface object i ,

W_i is an activation susceptibility number associated with the user interface object i ,

d_i is a distance between the first position and the user interface object i ,

n is a real number (e.g., 1), and

\vec{u}_i is a unit vector along the direction of $\Delta \vec{d}_i$.

If the determined cursor position P is on a particular user interface object (e.g., **5602** in FIG. **56E**), the user interface object is activated to perform a predefined operation such as playing a song, deleting an email message, or entering a character to an input field.

In some embodiments, the activation susceptibility numbers assigned to different user interface objects have different values and signs depending on the operation associated with each object.

For example, as shown in FIG. **56E**, if the operation associated with the user interface object **5602** is reversible or otherwise non-destructive (e.g., the user interface object **5602** is the play icon **2304** of the music and video player module in FIG. **23C**), an activation susceptibility number W_1 having a first sign (e.g., "+") is assigned to the object **5602** such that the determined cursor position P is drawn closer to the object **5602** than the first position P_1 , rendering the object **5602** easier to be activated. In this context, "non-destructive" is defined to mean an action that will not cause a permanent loss of information.

In contrast, as shown in FIG. **56F**, if the operation associated with the user interface object **5602** is irreversible or destructive of user information (e.g., the user interface object **5602** is the delete icon **3542** of the email module in FIG. **35E**), an activation susceptibility number W_1 having a second sign (e.g., "-") opposite to the first sign is assigned to the object **5602** such that the determined cursor position P may be further away from the object **5602** than the first position P_1 , rendering the object **5602** harder to activate. Thus, when an object's associated activation susceptibility number has the second sign, the contact must be relatively precisely positioned over the object in order to activate it, with larger values of the activation susceptibility number corresponding to higher degrees of precision.

In some embodiments, the cursor position P is determined based on the first position, the activation susceptibility number associated with a user interface object that is closest to the first position, and the distance between the first position and the user interface object that is closest to the first position. In these embodiments, the cursor position P is not affected by the parameters associated with other neighboring user interface objects. For example, as shown in FIG. **56K**, the first position P_1 is closest to the user interface object **5602** that has an associated activation susceptibility number W_1 . The distance between the first position P_1 and the object **5602** is d_1 .

The cursor position P to be determined is only affected by these parameters, not by other neighboring user interface objects **5604**, **5606** or **5608**.

In some embodiments, as shown in FIG. **56L**, the cursor position is the same as the first position, which may be P₁ in FIG. **56B** or P₂ in FIG. **56H**, if the first position is within a particular user interface object (e.g., **5604**) on the display. In this case, there is no need to further offset the cursor position from the first position.

In some embodiments, as shown in FIG. **56E**, a finger contact does not have to occur exactly at an object to activate the object. Rather, the user interface object is activated as long as the determined cursor position falls within the user interface object. In some embodiments, a user interface object is activated if the determined cursor position falls within a user interface object's hidden hit region. For more information about an object's hidden hit region, please refer to the description below in connection with FIGS. **58A-58D**.

In some embodiments, at least some of the user interface objects involved in determining the cursor position in the formula above are visible on the touch screen display.

In some embodiments, the activation susceptibility numbers associated with the user interface objects (e.g., W₁-W₄) are context-dependent in a specific application module and change from one context to another context within the specific application module. For example, an object may have a first activation susceptibility number that is attractive to a cursor position at a first moment (in a first context of a specific application module), but a second activation susceptibility number that is less attractive or even repulsive (e.g., if the second activation susceptibility number has an opposite sign) to the cursor position at a second moment (in a second context of the specific application module).

FIGS. **56M-56O** illustrate an exemplary method for dynamically adjusting activation susceptibility numbers associated with soft keyboard keys as a word is typed with the soft keyboard keys in accordance with some embodiments. The user interface includes an input field **5620** and a soft keyboard **5640**. A user selection of any key icon of the soft keyboard **5640** enters a corresponding user-selected character in the input field **5620**. For illustrative purposes, as shown in FIG. **56M**, all the key icons initially have the same activation susceptibility number, 5.

FIG. **56N** depicts the activation susceptibility numbers associated with different key icons after two characters "Go" are entered into the input field **5620**. The activation susceptibility numbers associated with the key icons have been adjusted in accordance with the previously entered characters. For example, the activation susceptibility number of key icon "D" changes from 5 to 10 because "God" is a common English word. Thus, the key icon "D" may be activated even if the next finger contact is closer to the key icon "F" than to the key icon "D" itself. Similarly, the activation susceptibility numbers associated with key icons "A" and "O" are also increased because each of the strings "Goa" and "Goo" leads to one or more legitimate English words such as "Goal", "Good", or "Goad." In contrast, the activation susceptibility number of key icon "K" drops to 3 because the string "Gok" is not found at the beginning of any common English words.

FIG. **56O** depicts the updated activation susceptibility numbers associated with different key icons after another character "a" is entered into the input field **5620**. Given the string "Goa" that has been entered, the user may be typing the word "Goal." Accordingly, the activation susceptibility number associated with the key icon "L" increases to 9 whereas the activation susceptibility number associated with the key

icon "O" drops to 2 because the string "Goao" is not found at the beginning of any common English words.

Additional description of determining a cursor position from a finger contact can be found in U.S. Provisional Patent Application No. 60/946,716, "Methods for Determining a Cursor Position from a Finger Contact with a Touch Screen Display," filed Jun. 27, 2007, and U.S. patent application Ser. No. 11/850,015, "Methods for Determining a Cursor Position from a Finger Contact with a Touch Screen Display," filed Sep. 4, 2007, the content of which is hereby incorporated by reference in its entirety.

Vertical and Horizontal Bars

As noted above, vertical and horizontal bars help a user understand what portion of a list or document is being displayed.

Vertical Bar for a List of Items

In some embodiments, a portable multifunction device displays a portion of a list of items on a touch screen display. The displayed portion of the list has a vertical position in the list.

In some embodiments, the list of items is a list of contacts (e.g. FIG. **8A**), a list of instant message conversations (e.g. FIG. **5**), a list of instant messages (e.g. FIG. **6A**), a list of photo albums (e.g. FIG. **13B**), a list of audio and/or video content (e.g. FIG. **21C**), a list of calendar entries (e.g. FIG. **49A**), a list of recent calls (e.g. FIG. **28B**), a list of mailboxes (e.g. FIG. **33**), a list of emails (e.g. FIG. **35A**), a list of settings (e.g. FIG. **36**), or a list of voicemail messages (e.g. FIG. **32A**).

An object is detected on or near the displayed portion of the list. In some embodiments, the object is a finger.

In response to detecting the object on or near the displayed portion of the list, a vertical bar is displayed on top of the displayed portion of the list. See, for example, vertical bar **640** in FIG. **6G**, and vertical bar **1314** in FIG. **13A**. The vertical bar has a vertical position on top of the displayed portion of the list that corresponds to the vertical position in the list of the displayed portion of the list. In some embodiments, the vertical bar has a vertical length that corresponds to the portion of the list being displayed. In some embodiments, the vertical bar is located on the right hand side of the displayed portion of the list. In some embodiments, the vertical bar is translucent or transparent. The vertical bar has a major axis and a portion of the list along the major axis of the vertical bar is not covered by the vertical bar.

In some embodiments, a movement of the object is detected on or near the displayed portion of the list. In some embodiments, the movement of the object is on the touch screen display. In some embodiments, the movement is a substantially vertical movement.

In response to detecting the movement, the list of items displayed on the touch screen display is scrolled so that a new portion of the list is displayed and the vertical position of the vertical bar is moved to a new position such that the new position corresponds to the vertical position in the list of the displayed new portion of the list. In some embodiments, scrolling the list has an associated speed of translation that corresponds to a speed of movement of the object. In some embodiments, scrolling the list is in accordance with a simulation of an equation of motion having friction.

After a predetermined condition is met, the display of the vertical bar is ceased. In some embodiments, the predetermined condition comprises ceasing to detect the object on or near the touch screen display. In some embodiments, the predetermined condition comprises ceasing to detect the object on or near the touch screen display for a predetermined

US 7,479,949 B2

101

time period. In some embodiments, the predetermined condition comprises ceasing to detect the object on or near the displayed portion of the list.

A graphical user interface on a portable multifunction device with a touch screen display comprises a portion of a list of items displayed on the touch screen display, wherein the displayed portion of the list has a vertical position in the list, and a vertical bar displayed on top of the portion of the list of items. In response to detecting an object on or near the displayed portion of the list, the vertical bar is displayed on top of the portion of the list of items. The vertical bar has a vertical position on top of the displayed portion of the list that corresponds to the vertical position in the list of the displayed portion of the list. After a predetermined condition is met, the display of the vertical bar is ceased.

Vertical Bar for an Electronic Document

In some embodiments, a portable multifunction device displays a portion of an electronic document on a touch screen display. The displayed portion of the electronic document has a vertical position in the electronic document. In some embodiments, the electronic document is a web page. In some embodiments, the electronic document is a word processing, spreadsheet, email or presentation document.

An object is detected on or near the displayed portion of the electronic document. In some embodiments, the object is a finger.

In response to detecting the object on or near the displayed portion of the electronic document, a vertical bar is displayed on top of the displayed portion of the electronic document. See for example vertical bar **1222** in FIG. **12A** and vertical bar **3962** in FIG. **39H**. The vertical bar has a vertical position on top of the displayed portion of the electronic document that corresponds to the vertical position in the electronic document of the displayed portion of the electronic document. In some embodiments, the vertical bar has a vertical length that corresponds to the portion of the electronic document being displayed. In some embodiments, the vertical bar is located on the right hand side of the displayed portion of the electronic document. In some embodiments, the vertical bar is translucent or transparent. The vertical bar has a major axis and a portion of the electronic document along the major axis of the vertical bar is not covered by the vertical bar (see, for example, vertical bar **1222** in FIG. **12**, and vertical bar **3962** in FIG. **39H**).

In some embodiments, a movement of the object is detected on or near the displayed portion of the electronic document. In some embodiments, the movement of the object is on the touch screen display. In some embodiments, the movement is a substantially vertical movement.

In response to detecting the movement, the electronic document displayed on the touch screen display is scrolled so that a new portion of the electronic document is displayed, and the vertical position of the vertical bar is moved to a new position such that the new position corresponds to the vertical position in the electronic document of the displayed new portion of the electronic document. In some embodiments, scrolling the electronic document has an associated speed of translation that corresponds to a speed of movement of the object. In some embodiments, scrolling the electronic document is in accordance with a simulation of an equation of motion having friction.

After a predetermined condition is met, the display of the vertical bar is ceased. In some embodiments, the predetermined condition comprises ceasing to detect the object on or near the touch screen display. In some embodiments, the predetermined condition comprises ceasing to detect the

102

object on or near the touch screen display for a predetermined time period. In some embodiments, the predetermined condition comprises ceasing to detect the object on or near the displayed portion of the electronic document.

A graphical user interface on a portable multifunction device with a touch screen display comprises a portion of an electronic document displayed on the touch screen display, wherein the displayed portion of the electronic document has a vertical position in the electronic document, and a vertical bar displayed on top of the portion of the electronic document. In response to detecting an object on or near the displayed portion of the electronic document, the vertical bar is displayed on top of the portion of the electronic document. The vertical bar has a vertical position on top of the displayed portion of the electronic document that corresponds to the vertical position in the electronic document of the displayed portion of the electronic document. After a predetermined condition is met, the display of the vertical bar is ceased.

Vertical Bar and Horizontal Bar for an Electronic Document

In some embodiments, a portable multifunction device displays a portion of an electronic document on a touch screen display. The displayed portion of the electronic document has a vertical position in the electronic document and a horizontal position in the electronic document. In some embodiments, the electronic document is a web page. See for example FIG. **39A**. In some embodiments, the electronic document is a word processing, spreadsheet, email or presentation document.

An object is detected on or near the displayed portion of the electronic document. In some embodiments, the object is a finger.

In response to detecting the object on or near the displayed portion of the electronic document, a vertical bar and a horizontal bar are displayed on top of the displayed portion of the electronic document. See for example vertical bar **3962** and horizontal bar **3964** in FIG. **39H**. In some embodiments, the vertical bar is located on the right hand side of the displayed portion of the electronic document and the horizontal bar is located on the bottom side of the displayed portion of the electronic document. In some embodiments, the vertical bar and the horizontal bar are translucent or transparent.

The vertical bar has a vertical position on top of the displayed portion of the electronic document that corresponds to the vertical position in the electronic document of the displayed portion of the electronic document. In some embodiments, the vertical bar has a vertical length that corresponds to the vertical portion of the electronic document being displayed. The vertical bar has a major axis and a portion of the electronic document along the major axis of the vertical bar is not covered by the vertical bar.

The horizontal bar has a horizontal position on top of the displayed portion of the electronic document that corresponds to the horizontal position in the electronic document of the displayed portion of the electronic document. In some embodiments, the horizontal bar has a horizontal length that corresponds to the horizontal portion of the electronic document being displayed. The horizontal bar has a major axis, substantially perpendicular to the major axis of the vertical bar, and a portion of the electronic document along the major axis of the horizontal bar is not covered by the horizontal bar.

In some embodiments, a movement of the object is detected on or near the displayed portion of the electronic document. In some embodiments, the movement of the object is on the touch screen display.

In response to detecting the movement, the electronic document displayed on the touch screen display is translated

103

so that a new portion of the electronic document is displayed. In some embodiments, the electronic document is translated in a vertical direction, a horizontal direction, or a diagonal direction. In some embodiments, the electronic document is translated in accordance with the movement of the object. In some embodiments, translating the electronic document has an associated speed of translation that corresponds to a speed of movement of the object. In some embodiments, translating the electronic document is in accordance with a simulation of an equation of motion having friction.

In response to detecting the movement, the vertical position of the vertical bar is moved to a new vertical position such that the new vertical position corresponds to the vertical position in the electronic document of the displayed new portion of the electronic document.

In response to detecting the movement, the horizontal position of the horizontal bar is moved to a new horizontal position such that the new horizontal position corresponds to the horizontal position in the electronic document of the displayed new portion of the electronic document.

After a predetermined condition is met, the display of the vertical bar and the horizontal bar is ceased. In some embodiments, the predetermined condition comprises ceasing to detect the object on or near the touch screen display. In some embodiments, the predetermined condition comprises ceasing to detect the object on or near the touch screen display for a predetermined time period. In some embodiments, the predetermined condition comprises ceasing to detect the object on or near the displayed portion of the electronic document.

A graphical user interface on a portable multifunction device with a touch screen display comprises a portion of an electronic document displayed on the touch screen display. The displayed portion of the electronic document has a vertical position in the electronic document and a horizontal position in the electronic document. The GUI also comprises a vertical bar displayed on top of the portion of the electronic document, and a horizontal bar displayed on top of the portion of the electronic document. In response to detecting an object on or near the displayed portion of the electronic document, the vertical bar and the horizontal bar are displayed on top of the portion of the electronic document. The vertical bar has a vertical position on top of the displayed portion of the electronic document that corresponds to the vertical position in the electronic document of the displayed portion of the electronic document. The horizontal bar has a horizontal position on top of the displayed portion of the electronic document that corresponds to the horizontal position in the electronic document of the displayed portion of the electronic document. After a predetermined condition is met, the display of the vertical bar and the horizontal bar is ceased.

Vertical and horizontal bars may have, without limitation, a rectangular cross section, a rectangular cross section with rounded corners, or a racetrack oval cross section with two opposing flat sides and two opposing rounded sides.

Additional description of the horizontal and vertical bars can be found in U.S. Provisional Patent Application No. 60/947,386, "Portable Electronic Device, Method, and Graphical User Interface for Displaying Electronic Documents and Lists," filed Jun. 29, 2007, and U.S. patent application Ser. No. 11/968,059, "Portable Electronic Device, Method, and Graphical User Interface for Displaying Electronic Documents and Lists," filed Dec. 31, 2007, the content of which is hereby incorporated by reference in its entirety.

Gestures

FIGS. 57A-57C illustrate an exemplary screen rotation gesture in accordance with some embodiments.

104

In some embodiments, a portable multifunction device (e.g., device 100) displays a first application 5702 on a touch screen display (e.g., 112) in a portrait orientation (e.g., FIG. 57A). In some embodiments, the first application is a browser, a photo manager, a music player, or a video player. In some implementations, but not necessarily all, the display is rectangular, or substantially rectangular (e.g., the display may have rounded corners, but otherwise have a rectangular shape).

Simultaneous rotation of two thumbs (e.g., 5704-L and 5704-R) in a first sense of rotation is detected on the touch screen display 112. In some embodiments, the first sense of rotation is a clockwise rotation (e.g., FIG. 57C).

In some embodiments, the sense of rotation for each thumb is detected by monitoring the change in orientation of the contact area of the thumb with the touch screen display. For example, if the contact area of the thumb is elliptical, the change in the orientation of an axis of the ellipse may be detected (e.g., from contact ellipse 5706-L in FIG. 57A to contact ellipse 5708-L in FIG. 57B, as shown on an enlarged portion of touch screen 112 in FIG. 57C). In some embodiments, at least some of a user's other fingers (i.e., fingers other than thumbs 5704-L and 5704-R) support the device 100 by contacting the backside of the device.

In some embodiments, the first sense of rotation is a counterclockwise rotation. For example, if thumb 5704-L is initially on the lower left side of touch screen 112 (rather than the upper left side in FIG. 57A), thumb 5704-R is initially on the upper right side of touch screen 112 (rather than the lower right side in FIG. 57A), and the thumbs are moved apart from each other, then the sense of rotation detected by the touch screen 112 will be counterclockwise for both thumbs.

In response to detecting the simultaneous rotation of the two thumbs in the first sense of rotation, the first application 5702 is displayed in a landscape orientation.

In some embodiments, the simultaneous two-thumb rotation gesture is used to override automatic changes in portrait/landscape orientation based on analysis of data from accelerometers 168 until a predetermined condition is met. In some embodiments, any changes in orientation of the device that are detected after the simultaneous rotation of the two thumbs is detected are disregarded until the device displays a second application different from the first application. In some embodiments, any changes in orientation of the device that are detected after the simultaneous rotation of the two thumbs is detected are disregarded until the device is put in a locked state or turned off. In some embodiments, any changes in orientation of the device that are detected after the simultaneous rotation of the two thumbs is detected are disregarded for a predetermined time period.

In some embodiments, simultaneous rotation of the two thumbs is detected in a second sense of rotation that is opposite the first sense of rotation on the touch screen display. In response to detecting the simultaneous rotation of the two thumbs in the second sense of rotation, the first application is displayed in a portrait orientation.

In some embodiments, any changes in orientation of the device that are detected after the simultaneous rotation of the two thumbs in the first sense is detected are disregarded until the simultaneous rotation of the two thumbs in the second sense is detected.

A graphical user interface on a portable multifunction device with a touch screen display comprises an application that is displayed in either a first orientation or a second orientation, the second orientation being 90° from the first orientation. In response to detecting simultaneous rotation of two thumbs in a first sense of rotation on the touch screen

display, the display of the application changes from the first orientation to the second orientation. In some embodiments, the first orientation is a portrait orientation (e.g., FIG. 57A) and the second orientation is a landscape orientation (e.g., FIG. 57B). In some embodiments, the first orientation is a landscape orientation and the second orientation is a portrait orientation.

Additional description of gestures can be found in U.S. Provisional Patent Application Nos. 60/883,817, "Portable Electronic Device Performing Similar Operations For Different Gestures," filed Jan. 7, 2007, and 60/946,970, "Screen Rotation Gestures on a Portable Multifunction Device," filed Jun. 28, 2007, and U.S. patent application Ser. Nos. 11/850,638, "Portable Electronic Device Performing Similar Operations For Different Gestures," filed Sep. 5, 2007, and 11/960,667, "Screen Rotation Gestures on a Portable Multifunction Device," filed Dec. 19, 2007, the contents of which are hereby incorporated by reference in their entirety.

As noted above in connection with FIGS. 56A-56L, a cursor position for a finger contact with the touch screen display is adjusted in part based on the activation susceptibility numbers (or weights) assigned to user interface objects. Such cursor position adjustment helps to reduce the chance of selecting a user interface object by mistake. Another approach to improving the chance of hitting a user-desired object icon is to associate the object icon with a hidden hit region. The hidden hit region overlaps the object icon but is larger than the object icon.

An issue with the hidden hit region approach is how to choose one user interface object over another when the hit regions of the two objects partially overlap and a finger contact (as represented by its cursor position) happens to fall into the overlapping hit regions.

FIGS. 58A-58D illustrate a method of identifying a user-desired user interface object when a finger contact's corresponding cursor position falls into overlapping hit regions in accordance with some embodiments.

Two user interface objects, e.g., a button control user interface object 5802 and a slide control user interface object 5806, are deployed close to each other on the touch screen display. For example, the button control object 5802 may be the backup control icon 2320, the play icon 2304, or the forward icon 2322, and the slide control user interface object 5806 may be the volume control icon 2324 in the music and video player module (see, e.g., FIG. 23C).

The button control user interface object 5802 has a hidden hit region 5804 and the slide control user interface object 5806 has a hidden hit region 5816. The two hidden hit regions overlap at region 5810.

Initially, a finger-down event at a first position on the touch screen display is detected. As will be explained below in connection with FIGS. 59A-59G, a finger-down event may be a finger-in-range event or a finger-in-contact event at or near the touch screen display.

In some embodiments, as shown in FIG. 58A, the finger-down event occurs at a position 5805 in the overlapping hit region 5810. From the single finger-down event, it is impossible to determine whether the user intends to activate the button control user interface object 5802 or the slide control user interface object 5806.

In some embodiments, given the finger-down event position 5805, which is also the current cursor position, all the user interface objects that are associated with the position are identified. A user interface object is associated with a position if the position is within the user interface object or its hidden hit region. For illustrative purposes, the button control user interface object 5802 and the slide control user interface

object 5806 are identified as being associated with the first position 5805. Note that the slide control user interface object 5806 includes a slide bar 5803 and a slide object 5801.

Next, a finger-up event is detected at a second position on the touch screen display. As will be explained below in connection with FIGS. 59A-59G, a finger-up event may be a finger-out-of-contact event or a finger-out-of-range event at or near the touch screen display.

In some embodiments, or in some contexts of a specific application, the finger-out-of-contact event is used as the finger-up event instead of the finger-out-of-range event if the button control user interface object is activated, because a user receives a more prompt response. This is because, as shown in FIG. 59E, the finger-out-of-contact event occurs at an earlier time $t=t_4$ than the finger-out-of-range event, which occurs at time $t=t_5$.

In some embodiments, or in some contexts of a specific application, the finger-out-of-range event is used as the finger-up event instead of the finger-out-of-contact event if the slide control user interface object is activated because the pair of finger-in-range and finger-out-of-range events are often used to move the slide object along the slide bar.

Given the first and second positions corresponding to the finger-down and finger-up events, a distance between the two positions is determined. If the distance is equal to or less than a first predefined threshold, the device performs a first action with respect to a first user interface object. If the distance is greater than a second predefined threshold, the device performs a second action with respect to a second user interface object. The first user interface object is different from the second user interface object. In some embodiments, the first and second predefined thresholds are the same. In some other embodiments, the second predefined threshold is higher than the first predefined threshold. In the latter embodiments, if the distance is between the two positions is between the first and second thresholds, neither the first nor the second user interface object is activated (or more generally, no action is performed with respect to either object. As a result, the user will need to more clearly indicate his or her intent by performing another gesture.

In some contexts in which the user gesture activates the slide control user interface object 5806, the second position is within the hit region 5816 of the slide control user interface object 5806 (5808 in FIG. 58A). In some other contexts in which the user gesture activates the slide control user interface object 5806, the second position is outside hit region 5816 (5809 in FIG. 58B), but has a projection onto the slide bar. In either case, the device moves the slide object 5801 along the slide bar 5803 in accordance with the distance between the first position and the second position. In some embodiments, the distance between the two positions is projected onto the slide bar. As shown in FIGS. 58A-58B, the projected distance Δd_x corresponds to the amount by which the slide object 5801 is moved along the slide bar 5803.

In some contexts in which the user gesture activates the button control user interface object 5802, the second position is also within the overlapping hit region (5803 in FIG. 58C). In some other contexts in which the user gesture activates the button control user interface object 5802, the second position is within the hit region 5804 of the object 5802, but not within the slide control user interface object 5806's hit region. In either case, the device activates the button control user interface object 5802 to perform a predefined operation.

In some embodiments, after the finger-down event and before the finger-up event, a series of finger-dragging events are detected at positions on the touch screen display, but outside the slide control user interface object 5806's hit

region 5816. In this case, the device moves the slide object 5801 along the slide bar 5803 from its current position to a different position determined at least in part by each finger-dragging event's associated position on the touch screen display. The slide object 5801 stops at the second position when the finger-up event is detected. Exemplary graphical user interfaces of this embodiment are in FIGS. 47A-47E.

Additional description of interpreting a finger gesture can be found in U.S. Provisional Patent Application No. 60/946,977, "Portable Multifunction Device, Method, and Graphical User Interface for Interpreting a Finger Gesture on a Touch Screen Display," filed Jun. 28, 2007, and U.S. patent application Ser. No. 11/969,796, "Portable Multifunction Device, Method, and Graphical User Interface for Interpreting a Finger Gesture on a Touch Screen Display," filed Jan. 4, 2008, the content of which is hereby incorporated by reference in its entirety.

Two types of finger gestures that a user may apply to a touch screen display are: (i) a finger tap or (ii) a finger swipe. A finger tap often occurs at a button-style user interface object (e.g., a key icon of the soft keyboard) and a finger swipe is often (but not always) associated with a slide control user interface object (e.g., the volume control icon of the music and video player).

In some embodiments, a parameter is used to describe the process of a finger approaching a touch screen display, contacting the touch screen display, and leaving the touch screen display. The parameter can be a distance between the finger and the touch screen display, a pressure the finger has on the touch screen display, a contact area between the finger and the touch screen, a voltage between the finger and the touch screen, a capacitance between the finger and the touch screen display or a function of one or more of the physical parameters.

In some embodiments, depending on the magnitude of the parameter (e.g., capacitance) between the finger and the touch screen display, the finger is described as (i) out of range from the touch screen display if the parameter is below an in-range threshold, (ii) in-range but out of contact with the touch screen display if the parameter is above the in-range threshold but lower than an in-contact threshold, or (iii) in contact with the touch screen display if the parameter is above the in-contact threshold.

FIGS. 59A-59E illustrate how a finger tap gesture activates a soft key icon on a touch screen display in accordance with some embodiments.

At $t=t_1$ (FIG. 59A), a user's finger moves down to a distance d_1 away from the touch screen display 112 of the device 100. As shown in FIG. 59E, this distance d_1 is beyond the in-range distance threshold. Therefore, no key icon on the touch screen display gets highlighted.

At $t=t_2$ (FIG. 59B), the finger moves further down to a distance d_2 away from the touch screen display. As shown in FIG. 59E, this distance d_2 is at or slightly below (i.e., within) the in-range distance threshold. At this distance the user's finger is in-range of the touch screen display. As a result, the key icon "H" that is close to the finger on the touch screen display is highlighted. In some embodiments, an icon is highlighted by altering its color or altering its shape (e.g., magnifying the icon) or both to give an indication to the user of its status change.

At $t=t_3$ (FIG. 59C), the finger is distance d_3 away from the touch screen display. As shown in FIG. 59E, this distance d_3 is at or slightly below the in-contact distance threshold. At this distance, the user's finger is in-contact with the touch screen display. As a result, the key icon "H" is further highlighted. In some embodiments, an icon is further highlighted by display-

ing a magnified instance of the icon next to the icon. As shown in FIG. 59C, the magnified instance (which may have an appearance like a balloon) has a visual link with the key icon "H" on the soft keyboard.

At $t=t_4$ (FIG. 59D), the finger is lifted up to a distance d_4 away from the touch screen display. As shown in FIG. 59E, this distance d_4 is at or slightly above the in-contact distance threshold. In other words, the finger is just out of contact with the touch screen. In some embodiments, the sequence of finger movements from t_1 to t_4 corresponds to a finger tap gesture on the key icon "H". As a result, the key icon "H" is selected and entered into an input field at another location on the touch screen display.

At $t=t_5$ (FIG. 59E), the finger is further lifted up to a distance d_5 away from the touch screen display, indicating that the finger is just out of range from the touch screen. In some embodiments, the key icon is selected and entered into the input field at this moment.

In some embodiments, the in-contact threshold corresponds to a parameter such as capacitance between the finger and the touch screen display. It may or may not correlate with the event that the finger is in physical contact with the touch screen. For example, the finger may be deemed in contact with the screen if the capacitance between the two reaches the in-contact threshold while the finger has not physically touched the screen. Alternatively, the finger may be deemed out of contact with (but still in range from) the screen if the capacitance between the two is below the in-contact threshold while the finger has a slight physical contact the screen.

Note that the distances shown in FIG. 59A-59E or for that matter in other figures described in the application are exaggerated for illustrative purposes.

Additional description of interpreting a finger swipe gesture can be found in U.S. Provisional Patent Application No. 60/947,140, "Portable Multifunction Device, Method, and Graphical User Interface for Interpreting a Finger Swipe Gesture," filed Jun. 29, 2007, and U.S. patent application Ser. No. 11/961,700, "Portable Multifunction Device, Method, and Graphical User Interface for Interpreting a Finger Swipe Gesture," filed Dec. 20, 2007, the content of which is hereby incorporated by reference in its entirety.

FIGS. 59F-59H illustrate how a finger swipe gesture controls a slide control icon on a touch screen display in accordance with some embodiments.

At $t=t_6$ (FIG. 59F), the finger is close enough to the touch screen display such that a finger-in-contact event (see the cross at position A in FIG. 59H) is detected at a first position A on the touch screen display. A user interface object such as a slide control icon is identified at the position A. The slide control icon may include a slide bar and a slide object that can move along the slide bar. In some embodiments, the slide object is at position A and the finger-in-contact event causes the slide object at position A to be activated.

In some embodiments, the slide object is activated by a finger-in-range event (see the cross at position A in FIG. 59G), not by a finger-in-contact event (see the cross at position E_1 in FIG. 59G).

At $t=t_8$ (FIG. 59F), the finger moves across the touch screen display until a finger-out-of-range event is detected at a second position C on the touch screen display (see, e.g., the crosses at position C in FIGS. 59G and 59H respectively).

Following the movement of the finger, the slide object on the touch screen display moves along the slide bar from the first position A to the second position C on the touch screen display. A distance between the first position A and the second position C on the touch screen display is determined.

In some embodiments, after the initial finger-in-contact or finger-in-range event at position A, the finger moves away from the slide control icon such that the finger is no longer in contact with the slide object when the finger-out-of-range event occurs. Please refer to the description in connection with FIGS. 47A-47E for detail. In this case, the distance by which the slide object is moved along the slide bar is determined by projecting the distance between the first position A and the second position C onto the slide bar.

In some embodiments, as shown in FIG. 59F, after the initial finger-in-contact event or finger-in-range event is detected, a finger-dragging event on or near the touch screen display is detected at $t=t_7$, which has an associated position on the touch screen display. Accordingly, the slide object is moved along the slide bar of the slider control icon from its first position A to position B, which is determined at least in part by the finger-dragging event's associated position on the touch screen display.

In some embodiments, the finger-dragging event is generated and detected repeatedly. Accordingly, the slide object is moved along the slide bar from one position to another position until the finger-out-of-range event is detected.

In some embodiments, as shown in FIGS. 59G and 59H, after the initial finger-in-contact or finger-in-range event is detected, the finger may be in contact with the touch screen display at one moment (see the cross at E_1 in FIGS. 59G and 59H), thereby generating a finger-in-contact event, and then out of contact with the display at another moment (see the cross at E_2 in FIGS. 59G and 59H), thereby generating a finger-out-contact event. But these pairs of finger-in-contact event and finger-out-of-contact event on the touch screen display have no effect on the movement of the slide object along the slide bar. In other words, during a particular finger swipe gesture on the display, the finger may be within a certain range from the touch screen display, but only in contact with the screen for a portion of the gesture (as shown in FIG. 59G), or it may even be the case that it is never in contact with the screen.

In some embodiments, a time period t from the moment t_6 of the finger-in-contact event or finger-in-range event to the moment t_8 of the finger-out-of-range event is determined. This time period t , in combination with the distance from the first position A to the second position C, determines whether a finger swipe gesture occurs on the touch screen display and if true, the distance by which (and the speed at which) the slide object needs to be moved along the slide bar until the finger-out-of-range event is detected.

Heuristics

In some embodiments, heuristics are used to translate imprecise finger gestures into actions desired by the user.

FIG. 64A is a flow diagram illustrating a method 6400 of applying one or more heuristics in accordance with some embodiments. A computing device with a touch screen display detects (6402) one or more finger contacts with the touch screen display. In some embodiments, the computing device is a portable multifunction device. In some embodiments, the computing device is a tablet computer. In some embodiments, the computing device is a desktop computer.

The device applies one or more heuristics to the one or more finger contacts to determine (6404) a command for the device. The device processes (6412) the command.

The one or more heuristics comprise: a heuristic for determining that the one or more finger contacts (e.g., 3937, FIG. 39C) correspond to a one-dimensional vertical screen scrolling command (6406); a heuristic for determining that the one or more finger contacts (e.g., 1626, FIG. 16A; 3532, FIG.

35B; or 3939, FIG. 39C) correspond to a two-dimensional screen translation command (6408); and a heuristic for determining that the one or more finger contacts (e.g., 1616 or 1620, FIG. 16A; 2416, FIG. 24A) correspond to a command to transition from displaying a respective item in a set of items to displaying a next item in the set of items (6410).

In some embodiments, the one or more heuristics include a heuristic for determining that the one or more finger contacts (e.g., 1616 or 1618, FIG. 16A; 2416, FIG. 24A) correspond to a command to transition from displaying a respective item in a set of items to displaying a previous item in the set of items.

In some embodiments, the one or more heuristics include a heuristic for determining that the one or more finger contacts correspond to a command to display a keyboard primarily comprising letters. For example, in some embodiments, gestures 1802 and 1818 (FIGS. 18D & 18E) correspond to a command to display a letter keyboard 616 (FIG. 18E). Similarly, in response to gestures 1804 and 1806 (FIGS. 18D & 18E), the letter keyboard 616 is displayed (FIG. 18E). In another example, a gesture 2506 (FIG. 25C) on a text entry box results in display of a letter keyboard 616 (FIG. 25D).

In some embodiments, the one or more heuristics include a heuristic for determining that the one or more finger contacts correspond to a command to display a keyboard primarily comprising numbers. For example, a gesture activating other number icon 812 (FIG. 8B) results in display of a numerical keyboard 624 (FIG. 9). In another example, a gesture on the zip code field 2654 in FIG. 26L results in display of a keyboard primarily comprising numbers (e.g., keyboard 624, FIG. 6C).

In some embodiments, the one or more heuristics include a heuristic for determining that the one or more finger contacts (e.g., gesture 3951, FIG. 39G) correspond to a one-dimensional horizontal screen scrolling command.

In some embodiments, the one or more heuristics include a heuristic for determining that the one or more finger contacts (e.g., contacts 3941 and 3943, FIG. 39C; contacts 3945 and 3947, FIG. 39D; contact by thumbs 5704-L and 5704-R, FIGS. 57A-57C) correspond to a 90° screen rotation command.

In some embodiments, the one or more heuristics include a heuristic for determining that the one or more finger contacts (e.g., gesture 1216 or 1218, FIG. 12A; gesture 1618 or 1620, FIG. 16A; gesture 3923, FIG. 39A) correspond to a command to zoom in by a predetermined amount.

In some embodiments, the one or more heuristics include a heuristic for determining that the one or more finger contacts (e.g., contacts 1910 and 1912, FIG. 19B; contacts 2010 and 2012, FIG. 20; contacts 3931 and 3933, FIG. 39C) correspond to a command to zoom in by a user-specified amount.

In some embodiments, the one or more heuristics include a heuristic for determining that the one or more finger contacts correspond to a command to show a heads up display. For example, contact with the touch screen 112 detected while a video 2302 (FIG. 23A) is playing results in showing the heads up display of FIG. 23C. In another example, detection of gesture 4030 (FIG. 40B) results in the display of one or more playback controls, as shown in FIG. 40C. The heads up display or playback controls may be displayed or superimposed over other content displayed on the touch screen 112.

In some embodiments, the one or more heuristics include a heuristic for determining that the one or more finger contacts (e.g., contact 2722, FIG. 27B) correspond to a command to reorder an item in a list.

In some embodiments, the one or more heuristics include a heuristic for determining that the one or more finger contacts

US 7,479,949 B2

111

(e.g., contact **4346**, FIG. **43L**) correspond to a command to replace a first user interface object with a second user interface object.

In some embodiments, the one or more heuristics include a heuristic for determining that the one or more finger contacts (e.g., contacts **4214**, FIGS. **42A** & **42C**) correspond to a command to translate content within a frame (e.g., frame **4204**) rather than translating an entire page that includes the frame.

In some embodiments, the one or more heuristics include a heuristic for determining that the one or more finger contacts correspond to a command to operate a slider icon (e.g., slider bar **4704**, FIGS. **47A-47B**; icon **4732**, FIGS. **47C-47E**) with one or more finger contacts (e.g., movements **4710**, **4712**, and **4714**, FIG. **47B**; movements **4738**, **4740**, and **4742**, FIG. **47D**) outside an area that includes the slider icon.

In some embodiments, the one or more heuristics include a heuristic for determining that the one or more finger contacts (e.g., a gesture moving the unlock image **302** across the channel **306**, FIGS. **3** & **53B**) correspond to a user interface unlock command.

In some embodiments, the one or more heuristics include a heuristic for determining which user interface object is selected when two user interface objects (e.g., button control user interface object **5802** and slide control user interface object **5806**, FIGS. **58A-D**) have overlapping hit regions (e.g., hit regions **5804** and **5816**).

In some embodiments, in one heuristic of the one or more heuristics, a contact (e.g., contact **3937**, FIG. **39C**) comprising a finger swipe gesture that initially moves within a predetermined angle of being perfectly vertical with respect to the touch screen display corresponds to a one-dimensional vertical screen scrolling command.

In some embodiments, in one heuristic of the one or more heuristics, a contact (e.g., contact **3939**, FIG. **39C**) comprising a moving finger gesture that initially moves within a predefined range of angles corresponds to a two-dimensional screen translation command.

In some embodiments, in one heuristic of the one or more heuristics, a contact comprising a finger swipe gesture that initially moves within a predetermined angle of being perfectly horizontal with respect to the touch screen display corresponds to a one-dimensional horizontal screen scrolling command. For example, a finger swipe gesture that initially moves within 27° of being perfectly horizontal corresponds to a horizontal scrolling command, in a manner analogous to vertical swipe gesture **3937** (FIG. **39C**).

In some embodiments, in one heuristic of the one or more heuristics, a contact (e.g., gestures **1802** and **1818**, FIGS. **18D** & **18E**; gesture **2506**, FIG. **25C**) comprising a finger tap gesture on a text box corresponds to a command to display a keyboard (e.g., keyboard **616**) primarily comprising letters.

In some embodiments, in one heuristic of the one or more heuristics, a contact (e.g., contacting other number icon **812**, FIG. **8B**; contacting the zip code field **2654** in FIG. **26L**) comprising a finger tap gesture on a number field corresponds to a command to display a keyboard primarily comprising numbers (e.g., keyboard **624**, FIG. **6C**).

In some embodiments, in one heuristic of the one or more heuristics, a contact (e.g., gesture **3941** and **3943**, FIG. **39C**; gesture **3945** and **3947**, FIG. **39D**) comprising a multifinger twisting gesture corresponds to a 90° screen rotation command.

In some embodiments, in one heuristic of the one or more heuristics, a contact (e.g., by thumbs **5704-L** and **5704-R**,

112

FIGS. **57A-57C**) comprising a simultaneous two-thumb twisting gesture corresponds to a 90° screen rotation command.

In some embodiments, in one heuristic of the one or more heuristics, a contact comprising a double tap gesture on a box of content in a structured electronic document (e.g., a double tap gesture on block **3914-5**, FIG. **39A**) corresponds to a command to enlarge and substantially center the box of content. In some embodiments, repeating the double tap gesture reverses the prior zoom-in operation, causing the prior view of the document to be restored.

In some embodiments, in one heuristic of the one or more heuristics, a multi-finger de-pinch gesture (e.g., gesture **3931** and **3933**, FIG. **39C**) corresponds to a command to enlarge information in a portion of the touch screen display in accordance with a position of the multi-finger de-pinch gesture and an amount of finger movement in the multi-finger de-pinch gesture.

In some embodiments, in one heuristic of the one or more heuristics, an N-finger translation gesture (e.g., **4210**, FIGS. **42A-42B**) corresponds to a command to translate an entire page of content and an M-finger translation gesture (e.g., **4214**, FIGS. **42A** & **42C**) corresponds to a command to translate content within a frame (e.g., frame **4204**, FIGS. **42A-42C**) rather than translating the entire page of content that includes the frame.

In some embodiments, in one heuristic of the one or more heuristics, a swipe gesture on an unlock icon (e.g., a gesture moving the unlock image **302** across the channel **306**, FIGS. **3** & **53B**) corresponds to a user interface unlock command.

These heuristics help the device to behave in the manner desired by the user despite inaccurate input by the user.

FIG. **64B** is a flow diagram illustrating a method **6430** of applying one or more heuristics in accordance with some embodiments. While the method **6430** described below includes a number of operations that appear to occur in a specific order, it should be apparent that the method **6430** can include more or fewer operations, that an order of two or more operations may be changed and/or that two or more operations may be combined into a single operation. For example, operations **6446-6456** may be performed prior to operations **6432-6444**.

A computing device with a touch screen display displays (**6432**) a web browser application (e.g., UI **3900A**, FIG. **39A**). In some embodiments, the computing device is a portable multifunction device. In some embodiments, the computing device is a tablet computer. In some embodiments, the computing device is a desktop computer.

While the computing device displays the web browser application, one or more first finger contacts with the touch screen display are detected (**6434**).

A first set of heuristics for the web browser application is applied (**6436**) to the one or more first finger contacts to determine a first command for the device. The first set of heuristics includes: a heuristic for determining that the one or more first finger contacts (e.g., **3937**, FIG. **39C**) correspond to a one-dimensional vertical screen scrolling command (**6438**); a heuristic for determining that the one or more first finger contacts (e.g., **1626**, FIG. **16A**; **3532**, FIG. **35B**; or **3939**, FIG. **39C**) correspond to a two-dimensional screen translation command (**6440**); and a heuristic for determining that the one or more first finger contacts (e.g., gesture **3951**, FIG. **39G**) correspond to a one-dimensional horizontal screen scrolling command (**6442**).

The first command is processed (**6444**). For example, the device executes the first command.

In some embodiments, the first set of heuristics includes a heuristic for determining that the one or more first finger contacts (e.g., contacts **3941** and **3943**, FIG. **39C**; contacts **3945** and **3947**, FIG. **39D**; contact by thumbs **5704-L** and **5704-R**, FIGS. **57A-57C**) correspond to a 90° screen rotation command.

In some embodiments, the first set of heuristics includes a heuristic for determining that the one or more first finger contacts (e.g., gesture **1216** or **1218**, FIG. **12A**; gesture **1618** or **1620**, FIG. **16A**; gesture **3923**, FIG. **39A**) correspond to a command to zoom in by a predetermined amount.

In some embodiments, the first set of heuristics includes a heuristic for determining that the one or more first finger contacts (e.g., contacts **1910** and **1912**, FIG. **19B**; contacts **2010** and **2012**, FIG. **20**; contacts **3931** and **3933**, FIG. **39C**) correspond to a command to zoom in by a user-specified amount.

In some embodiments, the first set of heuristics includes a heuristic for determining that the one or more first finger contacts (e.g., contact **3923** on block **3914-5**, FIG. **39A**) correspond to a command to enlarge and substantially center a box of content.

In some embodiments, the first set of heuristics includes a heuristic for determining that the one or more first finger contacts (e.g., contacts **4214**, FIGS. **42A & 42C**) correspond to a command to translate content within a frame (e.g., frame **4204**) rather than translating an entire page that includes the frame.

In some embodiments, the first set of heuristics includes: a heuristic for determining that the one or more first finger contacts correspond to a command to zoom in by a predetermined amount; a heuristic for determining that the one or more first finger contacts correspond to a command to zoom in by a user-specified amount; and a heuristic for determining that the one or more first finger contacts correspond to a command to enlarge and substantially center a box of content. In some embodiments, the first set of heuristics (or another set of heuristics) include one or more heuristics for reversing the prior zoom in operation, causing the prior view of a document or image to be restored in response to a repeat of the gesture (e.g., a double tap gesture).

While the device displays (**6446**) a photo album application (e.g., UI **1200A**, FIG. **12A**; UI **1600A**, FIG. **16A**; or UI **4300CC**, FIG. **43CC**), one or more second finger contacts with the touch screen display are detected (**6448**).

A second set of heuristics for the web browser application is applied (**6450**) to the one or more second finger contacts to determine a second command for the device. The second set of heuristics includes: a heuristic for determining that the one or more second finger contacts (e.g., **1218** or **1220**, FIG. **12A**; **1616** or **1620**, FIG. **16A**; **4399**, FIG. **43CC**) correspond to a command to transition from displaying a first image in a set of images to displaying a next image in the set of images (**6452**) and a heuristic for determining that the one or more second finger contacts (e.g., **1216** or **1220**, FIG. **12A**; **1616** or **1618**, FIG. **16A**; **4399**, FIG. **43CC**) correspond to a command to transition from displaying the first image in the set of images to displaying a previous image in the set of images (**6454**).

The second command is processed (**6456**). For example, the device executes the second command.

In some embodiments, the second set of heuristics includes a heuristic for determining that the one or more second finger contacts correspond to a command to zoom in by a predetermined amount. In some embodiments, the second set of heuristics (or another set of heuristics) include one or more heuristics for reversing the prior zoom in operation, causing the

prior view of an image to be restored in response to a repeat of the gesture (e.g., a double tap gesture).

In some embodiments, the second set of heuristics includes a heuristic for determining that the one or more second finger contacts correspond to a command to zoom in by a user-specified amount.

In some embodiments, the second set of heuristics includes: a heuristic for determining that the one or more second finger contacts correspond to a one-dimensional vertical screen scrolling command; a heuristic for determining that the one or more second finger contacts correspond to a two-dimensional screen translation command; and a heuristic for determining that the one or more second finger contacts correspond to a one-dimensional horizontal screen scrolling command.

In some embodiments, while the device displays an application that receives text input via the touch screen display (e.g., UI **1800D** and UI **1800E**, FIGS. **18D & 18E**; UI **2600L**, FIG. **26L**), one or more third finger contacts with the touch screen display are detected. A third set of heuristics for the application that receives text input is applied to the one or more third finger contacts to determine a third command for the device. The third set of heuristics includes a heuristic for determining that the one or more third finger contacts (e.g., gestures **1802** and **1818**, FIGS. **18D & 18E**) correspond to a command to display a keyboard primarily comprising letters (e.g., letter keyboard **616**, FIG. **18E**) and a heuristic for determining that the one or more third finger contacts (e.g., a gesture on the zip code field **2654**, FIG. **26L**) correspond to a command to display a keyboard primarily comprising numbers (e.g., numerical keyboard **624**, FIG. **9**). The third command is processed.

In some embodiments, while the device displays a video player application (e.g., UI **2300A**, FIG. **23A**), one or more fourth finger contacts with the touch screen display are detected. A fourth set of heuristics for the video player application is applied to the one or more fourth finger contacts to determine a fourth command for the device. The fourth set of heuristics includes a heuristic for determining that the one or more fourth finger contacts correspond to a command to operate a slider icon (e.g., slider bar **4704**, FIGS. **47A-47B**; icon **4732**, FIGS. **47C-47E**) with one or more finger contacts (e.g., movements **4710**, **4712**, and **4714**, FIG. **47B**; movements **4738**, **4740**, and **4742**, FIG. **47D**) outside an area that includes the slider icon. The fourth set of heuristics also includes a heuristic for determining that the one or more fourth finger contacts correspond to a command to show a heads up display. For example, contact with the touch screen **112** detected while a video **2302** (FIG. **23A**) is playing results in showing the heads up display of FIG. **23C**. The heads up display is superimposed over the video **2302** that is also being displayed on the touch screen **112**. In another example, detection of gesture **4030** (FIG. **40B**) results in the display of one or more playback controls, as shown in FIG. **40C**. In the example shown in FIG. **40C**, the playback controls are superimposed over inline multimedia content **4002-1** that is also being displayed on the touch screen **112**. The fourth command is processed.

The heuristics of method **6430**, like the heuristics of method **6400**, help the device to behave in the manner desired by the user despite inaccurate input by the user.

Additional description of heuristics can be found in U.S. Provisional Patent Application No. 60/937,991, "Touch Screen Device, Method, and Graphical User Interface for Determining Commands by Applying Heuristics," filed Jun. 29, 2007, and U.S. patent application Ser. No. 11/850,635, "Touch Screen Device, Method, and Graphical User Interface

for Determining Commands by Applying Heuristics,” filed Sep. 5, 2007, the content of which is hereby incorporated by reference in its entirety.

Keyboards

FIGS. 60A-60M illustrate exemplary soft keyboards in accordance with some embodiments.

A brief description of finger tap and finger swipe gestures is provided above in connection with FIGS. 59A-59H. The same model is used below to illustrate how the device responds to a continuous finger movement on its touch screen display.

FIGS. 60A-60G illustrate exemplary user interfaces for displaying one or more key icons in response to a continuous finger movement on or near a soft keyboard on a touch screen display in accordance with some embodiments. The soft keyboard includes multiple key icons.

At time $t=t_1$ (FIG. 60A), a finger-in-contact event is detected at the key icon “H” and the key icon “H” is highlighted.

In some embodiments, the key icon is highlighted by displaying a balloon-type symbol near the key icon. For example, as shown in FIG. 60A, the symbol is a magnified instance of the key icon “H”. There is a visual link between the magnified instance and the key icon “H” to further highlight their relationship.

In some embodiments, the highlighted key icon is activated if a finger-out-of-contact event is detected at the key icon. If so, the character “H” is entered into a predefined location on the display (e.g., in an input field).

Subsequently, when the finger moves away from the key icon “H”, the key icon “H” is de-highlighted. As shown in FIG. 60B, although the finger moves away from the key icon “H”, it is still in contact with the touch screen display. In other words, no finger-out-of-contact event is detected yet after the initial finger-in-contact event at $t=t_1$.

In some embodiments, the key icon is de-highlighted by removing the balloon-type symbol near the key icon “H”. Sometimes, there is a predefined time delay between moving the finger away from the key icon “H” and removing the adjacent symbol.

Next, while being in consistent contact with the touch screen display, the finger is detected to be in contact with a second key icon “C” at time $t=t_2$ and this key icon is highlighted accordingly.

In some embodiments, the second key icon “C” is highlighted by displaying a balloon-type symbol near the key icon. As shown in FIG. 60A, the symbol is a magnified instance of the key icon “C” near the key icon. There is also a visual link between the magnified instance and the key icon “C”.

When the finger moves away from the second key icon “C”, the second key icon is de-highlighted. The aforementioned series of operations repeats until a finger-out-of-contact event is detected at a particular location (e.g., the location occupied by the key icon “N”) on the touch screen at time $t=t_3$.

In some embodiments, the finger-out-of-contact event is triggered when the finger is lifted off the touch screen display, and this event causes the selection or activation of a corresponding object if the finger-out-of-contact event occurs over or within a predefined range of the object. Continuing with the exemplary user gesture shown in FIG. 60C, as a result of the finger-out-of-contact event, not only is the key icon “N” de-highlighted by removing its magnified instance, but an instance of the character “N” is displayed at a predefined location on the touch screen display (e.g., in a text input field).

As noted above, the distances d_1 and d_2 shown in FIG. 60A are exaggerated for illustrative purposes. In some embodiments, the finger is always in physical contact with the touch screen from time $t=t_1$ to time $t=t_3$. The distances may be correlated with the finger’s contact area or contact pressure on the touch screen display or the voltage or capacitance between the finger and the display.

As noted above in connection with FIG. 59B, a user interface object (e.g., a key icon) may be highlighted whenever a finger is within a predefined range from the object. Therefore, in some embodiments, as shown in FIGS. 60C-60D, a key icon is highlighted by altering its original appearance (without showing the balloon-type symbol) when the finger is within a predefined distance d_4 from the key icon at time $t=t_4$.

When the finger moves outside the predefined distance from the key icon, but still within a predefined range from the display (as shown in FIG. 60D), the key icon resumes its original appearance.

In some embodiments, an icon’s appearance is altered by changing its color or shape or both. In some other embodiments, an icon’s appearance is altered by covering it with a magnified instance of the same icon.

As shown in FIG. 60C, when the finger is moved within a predefined distance from the second key icon “C” at time $t=t_5$, the second key icon’s original appearance is altered accordingly and then resumes to its original appearance when the finger subsequently moves outside the predefined distance from the second key icon.

Note that a difference between the embodiment shown in FIGS. 60A-60B and the embodiment shown in FIGS. 60C-60D is that a character “N” is selected and entered into an input field at time $t=t_3$ in FIGS. 60A-60B, whereas no key icon is selected at time $t=t_6$ in FIGS. 60C-60D because no finger-in-contact event was detected in the latter case.

As noted above, a parameter is used to characterize the relationship between the finger and the touch screen display in some embodiments. This parameter may be a function of one or more other parameters such as a distance, a pressure, a contact area, a voltage, or a capacitance between the finger and the touch screen display.

In some embodiments, as shown in FIG. 60D, a user interface object (e.g., a first key icon) is highlighted (e.g., by altering its original appearance) when the parameter associated with the finger and the touch screen display occupied by the first key icon reaches or passes a first predefined level (e.g., the in-range threshold in FIG. 60D) in a first direction (e.g., in a decreasing direction).

In some embodiments, a highlighted key icon is then de-highlighted (e.g., by resuming its original appearance) when the parameter associated with the finger and the touch screen display occupied by the highlighted key icon reaches or passes the first predefined level (e.g., the in-range threshold in FIG. 60D) in a second direction that is opposite to the first direction (e.g., in an increasing direction).

In some embodiments, the first key icon is further highlighted (e.g., by displaying a balloon-type symbol next to the key icon) when the parameter associated with the finger and the touch screen display occupied by the first key icon reaches or passes a second predefined level (e.g., the in-contact threshold in FIG. 60B) in the first direction (e.g., in the decreasing direction).

In some embodiments, the highlighted key icon is de-highlighted (e.g., by removing the balloon-type symbol next to the key icon) when the parameter associated with the finger and the touch screen display occupied by the first key icon reaches or passes the second predefined level (e.g., the in-contact threshold in FIG. 60B) in a second direction that is

opposite to the first direction (e.g., in an increasing direction). In some embodiments, the key icon's associated character is selected and entered into a predefined text input field.

In some embodiments, as shown in FIGS. 60B and 60D, the first and second predefined levels are configured such that the parameter reaches the first predefined level before reaching the second predefined level in the first direction. But the parameter does not have to reach the second predefined level before reaching the first predefined level in the second direction that is opposite to the first direction. For example, the parameter has to first reach the in-range threshold before it reaches the in-contact threshold. But the parameter may never reach the in-contact threshold before it moves out of the range from the key icon.

As noted above, only one key icon is selected in the embodiment shown in FIGS. 60A-60B when the finger-out-of-contact event is detected at the key icon "N". Alternatively, a series of key icons can be selected without any finger-out-of-contact event if the parameter associated with the finger and the display is compared against another threshold level.

As shown in FIG. 60F, a new "selection" threshold is used to compare with the parameters. In this particular embodiment, the selection threshold is set to be below the in-contact threshold.

At time $t=t_7$, a key icon "H" is highlighted when the finger meets a first predefined condition.

In some embodiments, the first predefined condition is that the parameter associated with the finger and the touch screen display occupied by the key icon reaches or passes a first predefined level (e.g., the in-contact threshold) in a first direction (e.g., in an decreasing direction).

At time $t=t_8$, the key icon "H" is selected when the finger meets a second predefined condition and the finger stays within a predefined distance from the touch screen display.

In some embodiments, the second predefined condition is that the parameter associated with the finger and the touch screen display occupied by the key icon reaches or passes a second predefined level in a second direction that is opposite to the first direction while the finger is still within a predefined distance from the first icon. In some embodiments, an instance of the selected key icon is entered at a predefined location on the touch screen display.

At time $t=t_9$, a key icon "C" is highlighted when the finger meets the first predefined condition.

At time $t=t_{10}$, the key icon "C" is selected when the finger meets the second predefined condition and the finger stays within a predefined distance from the touch screen display.

The aforementioned operations repeat until a finger-out-of-contact event is detected at time $t=t_{12}$ and an instance of the character "N" is the last one entered into the corresponding text input field.

FIG. 60G is an exemplary graphical user interface illustrating a character string "HCN" is entered into the text field 6008 when the finger moves from position 6002 to 6004 and then to 6006. The three balloon-type symbols are displayed temporarily when the finger is in contact with their corresponding key icons on the soft keyboard. Advantageously, the aforementioned character input approach is faster than the approach as shown in FIGS. 59A-59D.

In some embodiments, a plurality of icons including first and second icons are displayed on the touch screen display. When a finger is in contact with the first icon, its appearance is altered to visually distinguish the first icon from other icons on the touch screen display. When the finger subsequently moves away from the first icon while still being in contact with the touch screen display, the visual distinction associated with the first icon is removed. Subsequently, the second

icon's appearance is altered to visually distinguish the second icon from other icons on the touch screen display when the finger is in contact with the second icon.

One challenge with entering characters through the soft keyboard shown in FIG. 60G is that the size of the key icons may be too small to hit for some users. Accordingly, FIGS. 60H-60M are exemplary graphical user interfaces illustrating different types of soft keyboards in accordance with some embodiments. These soft keyboards have larger key icons and are therefore more convenient for those users having difficulty with keyboards like that shown in FIG. 60G.

In response to a user request for soft keyboard, a first keyboard is displayed on the touch screen display. The first keyboard includes at least one multi-symbol key icon.

In some embodiments (as shown in FIG. 60H), the first soft keyboard includes multiple multi-symbol key icons. For example, the key icon 6010 includes five symbols "U", "V", "W", "X", and "Y".

Upon detecting a user selection of the multi-symbol key icon, the device replaces the first keyboard with a second keyboard. The second keyboard includes a plurality of single-symbol key icons and each single-symbol key icon corresponds to a respective symbol associated with the multi-symbol key icon.

FIG. 60I depicts a second keyboard replacing the first keyboard shown in FIG. 60H. Note that the top two rows of six multi-symbol key icons are replaced by two rows of five single-symbol key icons and a back key icon. Each of the five single-symbol key icons include one symbol from the multi-symbol key icon 6010.

In response to a user selection of one of the single-symbol key icons, an instance of a symbol associated with the user-selected single-symbol key icon is displayed at a predefined location on the touch screen display.

As shown in FIG. 60I, in response to a user selection of the single-symbol key icon 6017, a letter "U" is entered into the text field 6019. A user can easily tap any of the five single-symbol key icons because they are quite large. To return to the first keyboard with multi-symbol key icons, the user can tap the back key icon at the center of the top row of the second keyboard.

To enter a non-alphabetic character, the user can tap the keyboard switch icon 6015. As shown in FIG. 60J, a third soft keyboard replaces the second keyboard shown in FIG. 60I. In particular, each of the top two rows is a multi-symbol key icon including multiple non-alphabetic characters. For example, the key icon 6020 includes five digit symbols "6", "7", "8", "9", and "0".

A user selection of the key icon 6020 replaces the third keyboard with the fourth keyboard shown in FIG. 60K. Note that the top two rows of six multi-symbol key icons are now replaced by two rows of five single-symbol key icons and a back key icon. Each of the five single-symbol key icons include one digit symbol from the multi-symbol key icon 6020. A finger tap of the keyboard switch icon 6025 brings back the alphabetic multi-symbol keyboard shown in FIG. 60H.

In some embodiments, the top row of a soft keyboard is reserved for those single-symbol key icons and the second row of the keyboard displays multiple multi-symbol key icons.

As shown in FIG. 60L, a user selection of the multi-symbol key icon 6030 causes the top row to display five single-symbol key icons, each icon including one character from the multi-symbol key icon 6030.

In some embodiments, as shown in FIG. 60L, the user-selected multi-symbol key icon 6030 is displayed in a manner

US 7,479,949 B2

119

visually distinguishable from other icons on the same soft keyboard. The manner may include changing its color, shape or the like that is known to one skilled in the art.

The keyboard shown in FIG. 60L also includes a keyboard switch icon **6035**. Upon detecting a user selection of the keyboard switch icon **6035**, the device replaces the keyboard with another one as shown in FIG. 60M. Note that the keyboard in FIG. 60M includes another set of multi-symbol key icons such as **6040** in replacement of the multi-symbol key icons shown in the previous keyboard.

Additional description of soft keyboards can be found in U.S. Provisional Patent Application No. 60/946,714, "Portable Multifunction Device with Soft Keyboards," filed Jun. 27, 2007, and U.S. patent application Ser. No. 11/961,663, "Portable Multifunction Device with Soft Keyboards," filed Dec. 20, 2007, the content of which is hereby incorporated by reference in its entirety.

FIG. 61 illustrates an exemplary finger contact with a soft keyboard in accordance with some embodiments.

In some embodiments, user interface **6100** (FIG. 61) includes the following elements, or a subset or superset thereof:

402, **404**, and **406**, as described above;

Instant messages icon **602** that when activated (e.g., by a finger tap on the icon) initiates transition to a UI listing instant message conversations (e.g., UI **500**);

Names **504** of the people a user is having instant message conversations with (e.g., Jane Doe **504-1**) or the phone number if the person's name is not available (e.g., 408-123-4567 (**504-3**, FIG. 5);

Instant messages **604** from the other party, typically listed in order along one side of UI **6100**;

Instant messages **606** to the other party, typically listed in order along the opposite side of UI **6100** to show the back and forth interplay of messages in the conversation; Timestamps **608** for at least some of the instant messages; Text entry box **612**;

Send icon **614** that when activated (e.g., by a finger tap on the icon) initiates sending of the message in text entry box **612** to the other party (e.g., Jane Doe **504-1**);

Letter keyboard **616** for entering text in box **612**;

Word suggestion boxes **6102** and/or **6104** that when activated (e.g., by a finger tap on the icon) initiate display of a suggested word in text entry box **612** in place of a partially entered word.

In some embodiments, a finger contact detected on letter keyboard **616** partially overlaps two or more key icons. For example, finger contact **6106** includes overlap with the letter "u" **6108**, with the letter "j" **6110**, with the letter "k" **6112**, and with the letter "i" **6114**. In some embodiments, the letter with the largest partial overlap with the detected finger contact (i.e., with the highest percentage of overlap) is selected. Based on this letter and on previously entered text corresponding to an incomplete word, a suggested word is displayed in word suggestion boxes **6102** and/or **6104**.

In some embodiments, in response to detecting a finger contact on letter keyboard **616**, a letter is selected based on the extent of partial overlap with key icons and on the previously entered text corresponding to an incomplete word. For example, if a finger contact overlaps with four letter key icons, but only two of the letters when added to the previously entered text produce a possible correctly spelled word, whichever of the two letters has the largest partial overlap is selected. Based on the selected letter and on the previously entered text, a suggested word is then displayed in word suggestion boxes **6102** and/or **6104**.

120

Although FIG. 61 illustrates an exemplary user interface for predicting words based on detecting contact with a keyboard and on previously entered text in the context of instant messaging, analogous user interfaces are possible for any application involving text entry.

Additional description of keyboards can be found in U.S. Provisional Patent Application No. 60/883,806, "Soft Keyboard Display For A Portable Multifunction Device," filed Jan. 7, 2007, and U.S. patent application Ser. No. 11/850,641, "Soft Keyboard Display For A Portable Multifunction Device," filed Sep. 5, 2007, the content of which is hereby incorporated by reference in its entirety.

Settings

FIGS. 62A-62G illustrate exemplary user interfaces for displaying and adjusting settings in accordance with some embodiments.

In some embodiments, a portable multifunction device (e.g., device **100**) displays an airplane mode switch icon (e.g., icon **6202**, FIG. 62A) on a touch screen display (e.g., display **112**). The airplane mode switch icon has an "on" position (e.g., **6206**, FIG. 62B) and an "off" position (e.g., **6204**, FIG. 62A).

If the airplane mode switch icon is at the "off" position, a communications signal strength icon (e.g., **402**) is displayed on the touch screen display.

Upon detecting a movement of a finger contact on or near the airplane mode switch icon from the "off" position to the "on" position, the communications signal strength icon is replaced with an airplane icon (e.g., **6208**, FIG. 62B). In some embodiments, detecting the movement of the finger contact comprises detecting a finger-down event at or near the airplane mode switch icon at the "off" position, one or more finger-dragging events, and a finger-up event at or near the airplane mode switch icon at the "on" position.

For example, in UI **6200A** (FIG. 62A), a swipe gesture from the "off" position **6204** to the "on" position **6206** may be detected. In response to detecting the swipe gesture, the communications signal strength icon **402** is replaced with the airplane icon **6208** (FIG. 62B).

In some embodiments, replacing the communications signal strength icon with the plane icon includes moving the plane icon on the touch screen display towards the communications signal strength icon and then moving the plane icon over the communications signal strength icon. For example, the plane icon **6208** may appear at the edge of UI **6200A** (FIG. 62A) and move toward the communications signal strength icon **402**. Upon reaching the communications signal strength icon **402**, the plane icon **6208** moves over the communications signal strength icon **402** until the icon **402** is no longer displayed, as shown in FIG. 62B.

In some embodiments, the portable multifunction device includes a speaker and a sound is played while replacing the communications signal strength icon with the airplane icon.

In some embodiments, if the airplane mode switch icon is at the "on" position, upon detecting a finger-down event at or near the airplane mode switch icon at the "on" position, one or more finger-dragging events, and a finger-up event at or near the airplane mode switch icon at the "off" position, the airplane mode switch icon is moved from the "on" position to the "off" position and the plane icon is replaced with the communications signal strength icon.

For example, in UI **6200B** (FIG. 62B), a swipe gesture from the "on" position **6206** to the "off" position **6204** may be detected. In response to detecting the swipe gesture, the airplane mode switch icon **6202** is displayed in the "off" position

US 7,479,949 B2

121

and the airplane icon **6208** is replaced with the communications signal strength icon **402**, as shown in FIG. **62A**.

Additional description of airplane mode indicators can be found in U.S. Provisional Patent Application No. 60/947,315, "Airplane Mode Indicator on a Portable Multifunction Device," filed Jun. 29, 2007, and U.S. patent application Ser. No. 11/961,743, "Airplane Mode Indicator on a Portable Multifunction Device," filed Dec. 20, 2007, the content of which is hereby incorporated by reference in its entirety.

FIG. **62C** illustrates exemplary user interfaces for displaying and adjusting sound settings in accordance with some embodiments. In some embodiments, if user selects to adjust sound settings, UI **6200C** (FIG. **62C**) is displayed.

In some embodiments, a portable multifunction device (e.g., device **100**) displays a vibrate mode switch icon (e.g., icon **6212**, FIG. **62C**) on a touch screen display (e.g., display **112**). The vibrate mode switch icon has an "on" position (not shown) and an "off" position (e.g., **6214**, FIG. **62C**).

For example, in UI **6200C** (FIG. **62C**), a swipe gesture from the "off" position **6214** to the "on" position is detected. In response to detecting the swipe gesture, the vibrate mode switch icon **6212** is displayed in the "on position" and the device is set to be on vibrate mode.

In some embodiments, a contact with the settings icon **6210** (FIG. **62C**) is detected. In response to detecting the contact, the list of settings is displayed (UI **6200A**, FIG. **62A**).

FIG. **62D** illustrates exemplary user interfaces for displaying and adjusting wallpaper settings in accordance with some embodiments. In some embodiments, if a user selects to adjust wallpaper settings (e.g., by a finger tap anywhere in the wallpaper row in UI **6200A** (FIG. **62A**)), UI **6200D** (FIG. **62D**) is displayed. A user may change the wallpaper displayed on the device by making the desired selections on UI **6200D**.

FIG. **62E** illustrates exemplary user interfaces for displaying and adjusting general settings in accordance with some embodiments. In some embodiments, if user selects to adjust general settings, UI **6200E** (FIG. **62E**) is displayed. Some general settings may include about, backlight, date and time, keyboard, network, touch, legal, and reset settings.

For example, FIG. **62F** illustrates exemplary user interfaces for displaying and adjusting touch settings in accordance with some embodiments. In some embodiments, if a user selects to adjust touch settings (by selecting "touch" in UI **6200E** in FIG. **62E**), UI **6200F** (FIG. **62F**) is displayed.

In some embodiments, a portable multifunction device (e.g., device **100**) displays a show touch setting switch icon (e.g., icon **6232**, FIG. **62F**) on a touch screen display (e.g., display **112**). The slow touch setting switch icon has an "on" position (not shown) and an "off" position (e.g., **6234**, FIG. **62F**).

For example, in UI **6200F** (FIG. **62F**), a swipe gesture from the "off" position **6234** to the "on" position is detected. In response to detecting the swipe gesture, the show touch setting icon switch **6232** is displayed in the "on" position and the device is set to a show touch mode in which a shaded area corresponding to a user's finger contact area is displayed on the touch screen to aid the user in interacting with the touch screen.

FIG. **62G** illustrates exemplary user interfaces for displaying and adjusting iPod (trademark of Apple Computer, Inc.) settings in accordance with some embodiments. In some embodiments, if user selects iPod (trademark of Apple Computer, Inc.) settings, UI **6200G** (FIG. **62G**) is displayed.

In some embodiments, a portable multifunction device (e.g., device **100**) displays a shuffle mode icon (e.g., icon **6242**, FIG. **62F**) on a touch screen display (e.g., display **112**).

122

The shuffle mode icon has an "on" position (not shown) and an "off" position (e.g., **6244**, FIG. **62G**).

For example, in UI **6200G** (FIG. **62G**), a swipe gesture from the "off" position **6244** to the "on" position is detected. In response to detecting the swipe gesture, the shuffle mode switch **6242** is displayed in the "on" position and the iPod (trademark of Apple Computer, Inc.) feature of the device is set to a shuffle mode.

FIG. **63** illustrates an exemplary method for adjusting dimming timers in accordance with some embodiments. Additional description of dimming techniques can be found in U.S. Provisional Patent Application No. 60/883,821, "Portable Electronic Device With Auto-Dim Timers," filed Jan. 7, 2007, and U.S. patent application Ser. No. 11/960,677, "Portable Electronic Device With Auto-Dim Timers," filed Dec. 19, 2007, the content of which is hereby incorporated by reference in its entirety.

Additional description of settings-related techniques can be found in U.S. Provisional Patent Application No. 60/883,812, "Portable Electronic Device With A Global Setting User Interface," filed Jan. 7, 2007, and U.S. patent application Ser. No. 11/960,669, "Portable Electronic Device With A Global Setting User Interface," filed Dec. 19, 2007, the content of which is hereby incorporated by reference in its entirety.

The foregoing description, for purpose of explanation, has been described with reference to specific embodiments. However, the illustrative discussions above are not intended to be exhaustive or to limit the invention to the precise forms disclosed. Many modifications and variations are possible in view of the above teachings. The embodiments were chosen and described in order to best explain the principles of the invention and its practical applications, to thereby enable others skilled in the art to best utilize the invention and various embodiments with various modifications as are suited to the particular use contemplated.

What is claimed is:

1. A computing device, comprising:

a touch screen display;
one or more processors;
memory; and

one or more programs, wherein the one or more programs are stored in the memory and configured to be executed by the one or more processors, the one or more programs including:

instructions for detecting one or more finger contacts with the touch screen display;
instructions for applying one or more heuristics to the one or more finger contacts to determine a command for the device; and
instructions for processing the command;
wherein the one or more heuristics comprise:

a vertical screen scrolling heuristic for determining that the one or more finger contacts correspond to a one-dimensional vertical screen scrolling command rather than a two-dimensional screen translation command based on an angle of initial movement of a finger contact with respect to the touch screen display;

a two-dimensional screen translation heuristic for determining that the one or more finger contacts correspond to the two-dimensional screen translation command rather than the one-dimensional vertical screen scrolling command based on the angle of initial movement of the finger contact with respect to the touch screen display; and

a next item heuristic for determining that the one or more finger contacts correspond to a command to

US 7,479,949 B2

123

transition from displaying a respective item in a set of items to displaying a next item in the set of items.

2. The computing device of claim 1, wherein the one or more heuristics include a heuristic for determining that the one or more finger contacts correspond to a command to translate content within a frame rather than translating an entire page that includes the frame.

3. The computing device of claim 1, wherein the one or more heuristics include a heuristic for determining which user interface object is selected when two user interface objects have overlapping hit regions.

4. The computing device of claim 1, wherein, in one heuristic of the one or more heuristics, a contact comprising a finger swipe gesture that initially moves within a predetermined angle of being perfectly vertical with respect to the touch screen display corresponds to the one-dimensional vertical screen scrolling command.

5. The computing device of claim 1, wherein, in one heuristic of the one or more heuristics, a contact comprising a moving finger gesture that initially moves within a predefined range of angles corresponds to the two-dimensional screen translation command.

6. The computing device of claim 1, wherein, in one heuristic of the one or more heuristics, a contact comprising a finger swipe gesture that initially moves within a predetermined angle of being perfectly horizontal with respect to the touch screen display corresponds to a one-dimensional horizontal screen scrolling command rather than the two-dimensional screen translation command.

7. The computing device of claim 1, wherein, in one heuristic of the one or more heuristics, a contact comprising a simultaneous two-thumb twisting gesture corresponds to a 90° screen rotation command.

8. The computing device of claim 1, wherein, in one heuristic of the one or more heuristics, an N-finger translation gesture corresponds to a command to translate an entire page of content and an M-finger translation gesture corresponds to a command to translate content within a frame rather than translating the entire page of content that includes the frame.

9. The computing device of claim 1, including:
instructions for detecting one or more first finger contacts with the touch screen display while a web browser application is displayed on the touch screen display;
instructions for applying a first set of heuristics for the web browser application to the one or more first finger contacts to determine a first command for the device; and
instructions for processing the first command;
wherein the first set of heuristics comprises:
the vertical screen scrolling heuristic; and
the two-dimensional screen translation heuristic; and
instructions for detecting one or more second finger contacts with the touch screen display while a photo album application is displayed on the touch screen display;
instructions for applying a second set of heuristics for the photo album application to the one or more second finger contacts to determine a second command for the device; and
instructions for processing the second command;

wherein the second set of heuristics comprises:
the next item heuristic, wherein the respective item in the set of items is a respective image in a set of images; and

a heuristic for determining that the one or more second finger contacts correspond to a command to transition from displaying the respective image in the set of images to displaying a previous image in the set of images.

124

10. The computing device of claim 9, wherein the first set of heuristics comprises a heuristic for determining that the one or more first finger contacts correspond to a one-dimensional horizontal screen scrolling command rather than the two-dimensional screen translation command based on the angle of initial movement of the finger contact with respect to the touch screen display.

11. A computer-implemented method, comprising:
at a computing device with a touch screen display,
detecting one or more finger contacts with the touch screen display;
applying one or more heuristics to the one or more finger contacts to determine a command for the device; and
processing the command;

wherein the one or more heuristics comprise:
a vertical screen scrolling heuristic for determining that the one or more finger contacts correspond to a one-dimensional vertical screen scrolling command rather than a two-dimensional screen translation command based on an angle of initial movement of a finger contact with respect to the touch screen display;

a two-dimensional screen translation heuristic for determining that the one or more finger contacts correspond to the two-dimensional screen translation command rather than the one-dimensional vertical screen scrolling command based on the angle of initial movement of the finger contact with respect to the touch screen display; and

a next item heuristic for determining that the one or more finger contacts correspond to a command to transition from displaying a respective item in a set of items to displaying a next item in the set of items.

12. The computer-implemented method of claim 11, including:

while displaying a web browser application,
detecting one or more first finger contacts with the touch screen display;
applying a first set of heuristics for the web browser application to the one or more first finger contacts to determine a first command for the device; and
processing the first command;

wherein the first set of heuristics comprises:
the vertical screen scrolling heuristic; and
the two-dimensional screen translation heuristic; and

while displaying a photo album application,
detecting one or more second finger contacts with the touch screen display;

applying a second set of heuristics for the photo album application to the one or more second finger contacts to determine a second command for the device; and
processing the second command;

wherein the second set of heuristics comprises:
the next item heuristic, wherein the respective item in the set of items is a respective image in a set of images; and

a heuristic for determining that the one or more second finger contacts correspond to a command to transition from displaying the respective image in the set of images to displaying a previous image in the set of images.

13. The computer-implemented method of claim 12, wherein the first set of heuristics comprises a heuristic for determining that the one or more first finger contacts correspond to a one-dimensional horizontal screen scrolling command rather than the two-dimensional screen translation

US 7,479,949 B2

125

command based on the angle of initial movement of the finger contact with respect to the touch screen display.

14. The computer-implemented method of claim 11, wherein, in one heuristic of the one or more heuristics, a contact comprising a finger swipe gesture that initially moves within a predetermined angle of being perfectly vertical with respect to the touch screen display corresponds to the one-dimensional vertical screen scrolling command.

15. The computer-implemented method of claim 11, wherein, in one heuristic of the one or more heuristics, a contact comprising a moving finger gesture that initially moves within a predefined range of angles corresponds to the two-dimensional screen translation command.

16. The computer-implemented method of claim 11, wherein, in one heuristic of the one or more heuristics, a contact comprising a finger swipe gesture that initially moves within a predetermined angle of being perfectly horizontal with respect to the touch screen display corresponds to a one-dimensional horizontal screen scrolling command rather than the two-dimensional screen translation command.

17. A computer readable storage medium having stored therein instructions, which when executed by a device with a touch screen display, cause the device to:

detect one or more finger contacts with the touch screen display;

apply one or more heuristics to the one or more finger contacts to determine a command for the device; and process the command;

wherein the one or more heuristics comprise:

a vertical screen scrolling heuristic for determining that the one or more finger contacts correspond to a one-dimensional vertical screen scrolling command rather than a two-dimensional screen translation command based on an angle of initial movement of a finger contact with respect to the touch screen display;

a two-dimensional screen translation heuristic for determining that the one or more finger contacts correspond to the two-dimensional screen translation command rather than the one-dimensional vertical screen scrolling command based on the angle of initial movement of the finger contact with respect to the touch screen display; and

a next item heuristic for determining that the one or more finger contacts correspond to a command to transition

126

from displaying a respective item in a set of items to displaying a next item in the set of items.

18. The computer readable storage medium of claim 17, wherein the computer readable medium has stored therein instructions, which when executed by a device with a touch screen display, cause the device to:

while displaying a web browser application, detect one or more first finger contacts with the touch screen display;

apply a first set of heuristics for the web browser application to the one or more first finger contacts to determine a first command for the device; and process the first command;

wherein the first set of heuristics comprises: the vertical screen scrolling heuristic; and the two-dimensional screen translation heuristic; and

while displaying a photo album application, detect one or more second finger contacts with the touch screen display;

apply a second set of heuristics for the photo album application to the one or more second finger contacts to determine a second command for the device; and process the second command;

wherein the second set of heuristics comprises: the next item heuristic, wherein the respective item in the set of items is a respective image in a set of images; and

a heuristic for determining that the one or more second finger contacts correspond to a command to transition from displaying the respective image in the set of images to displaying a previous image in the set of images.

19. The computer readable storage medium of claim 17, wherein, in one heuristic of the one or more heuristics, a contact comprising a finger swipe gesture that initially moves within a predetermined angle of being perfectly vertical with respect to the touch screen display corresponds to the one-dimensional vertical screen scrolling command.

20. The computer readable storage medium of claim 17, wherein, in one heuristic of the one or more heuristics, a contact comprising a moving finger gesture that initially moves within a predefined range of angles corresponds to the two-dimensional screen translation command.

* * * * *