

EXHIBIT A  
(Part 1 of 3)



US007840619B2

(12) **United States Patent  
Horn**

(10) **Patent No.: US 7,840,619 B2**  
(45) **Date of Patent: \*Nov. 23, 2010**

(54) **COMPUTER SYSTEM FOR AUTOMATIC ORGANIZATION, INDEXING AND VIEWING OF INFORMATION FROM MULTIPLE SOURCES**

6,094,649	A	7/2000	Bowen et al.	
6,401,097	B1 *	6/2002	McCotter et al. ....	707/102
6,457,017	B2 *	9/2002	Watkins et al. ....	707/103 R
6,523,022	B1	2/2003	Hobbs	
6,691,282	B1 *	2/2004	Rochford et al. ....	715/514
2003/0088593	A1 *	5/2003	Stickler .....	707/205

(76) Inventor: **Bruce L. Horn**, 436 Marin Ave. B, Mill Valley, CA (US) 94941

(\* ) Notice: Subject to any disclaimer, the term of this patent is extended or adjusted under 35 U.S.C. 154(b) by 308 days.

This patent is subject to a terminal disclaimer.

(21) Appl. No.: **11/903,304**

(22) Filed: **Sep. 21, 2007**

(65) **Prior Publication Data**

US 2008/0021921 A1 Jan. 24, 2008

**Related U.S. Application Data**

(62) Division of application No. 10/621,689, filed on Jul. 16, 2003, now Pat. No. 7,275,063.

(60) Provisional application No. 60/396,439, filed on Jul. 16, 2002.

(51) **Int. Cl.**  
**G06F 17/30** (2006.01)

(52) **U.S. Cl.** ..... **707/829; 707/830**

(58) **Field of Classification Search** ..... **707/102, 707/829, 830**

See application file for complete search history.

(56) **References Cited**

**U.S. PATENT DOCUMENTS**

5,425,139	A *	6/1995	Williams et al. ....	345/474
5,544,360	A *	8/1996	Lewak et al. ....	707/1
5,899,997	A	5/1999	Ellacott	

**OTHER PUBLICATIONS**

Dourish, Edwards, Lamarca and Salisbury, "Using Properties for Uniform Interaction in the Presto Document System," UIST 1999, Computer Science Laboratory, Xerox Palo Alto Research Center, 3333 Coyote Hill Road, Palo Alto, CA 94304.

\* cited by examiner

*Primary Examiner*—John E Breene

*Assistant Examiner*—Dennis Myint

(74) *Attorney, Agent, or Firm*—Jacques M. Dulin, Esq.; Innovation Law Group, Ltd.

(57) **ABSTRACT**

A computer data processing system including a central processing unit configured with a novel integrated computer control software system for the management of data objects including dynamic and automatic organization, linking, finding, cross-referencing, viewing and retrieval of multiple objects regardless of nature or source. The inventive system provides underlying component architecture having an object-oriented database structure and a metadata database structure which is unique in storing only one instance of each object while linking the object to multiple collections and domains by unique metadata links for the grouping into and retrieval from any of the collections. The system employs configurable, extensible attribute/properties of data objects in metadata format, and a truly user-friendly configurable interface that facilitates faster, more unified, comprehensive, useful and meaningful information management. Additional features include a sticky path object hierarchy viewing system, key phrase linking, viewing by reference, and drag-and-drop relationship link creation.

**1 Claim, 37 Drawing Sheets**

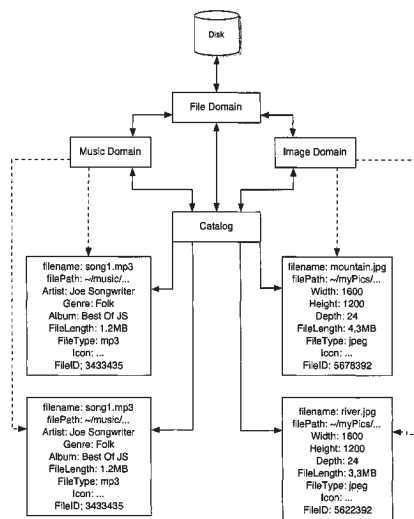

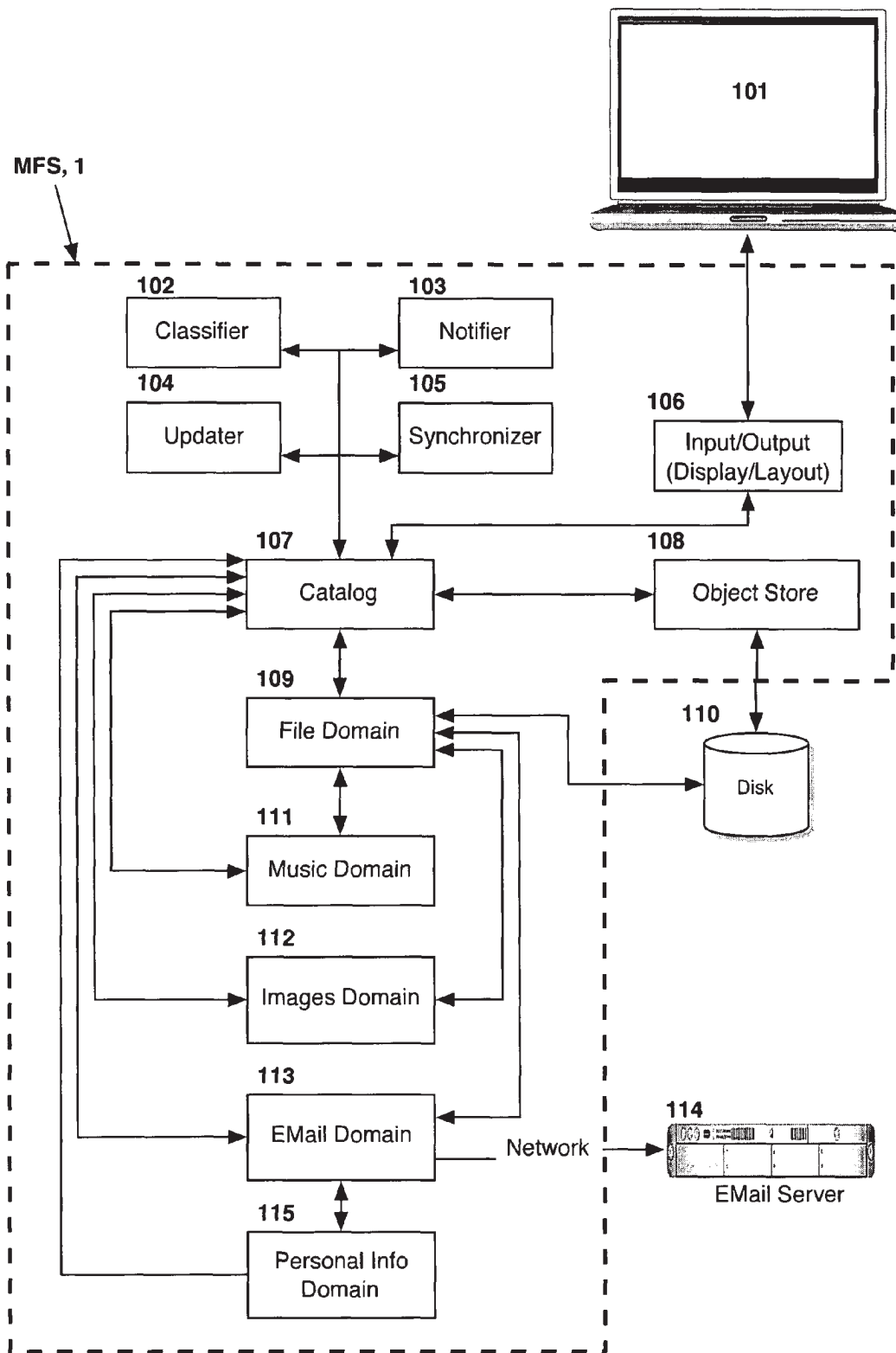

Figure 1

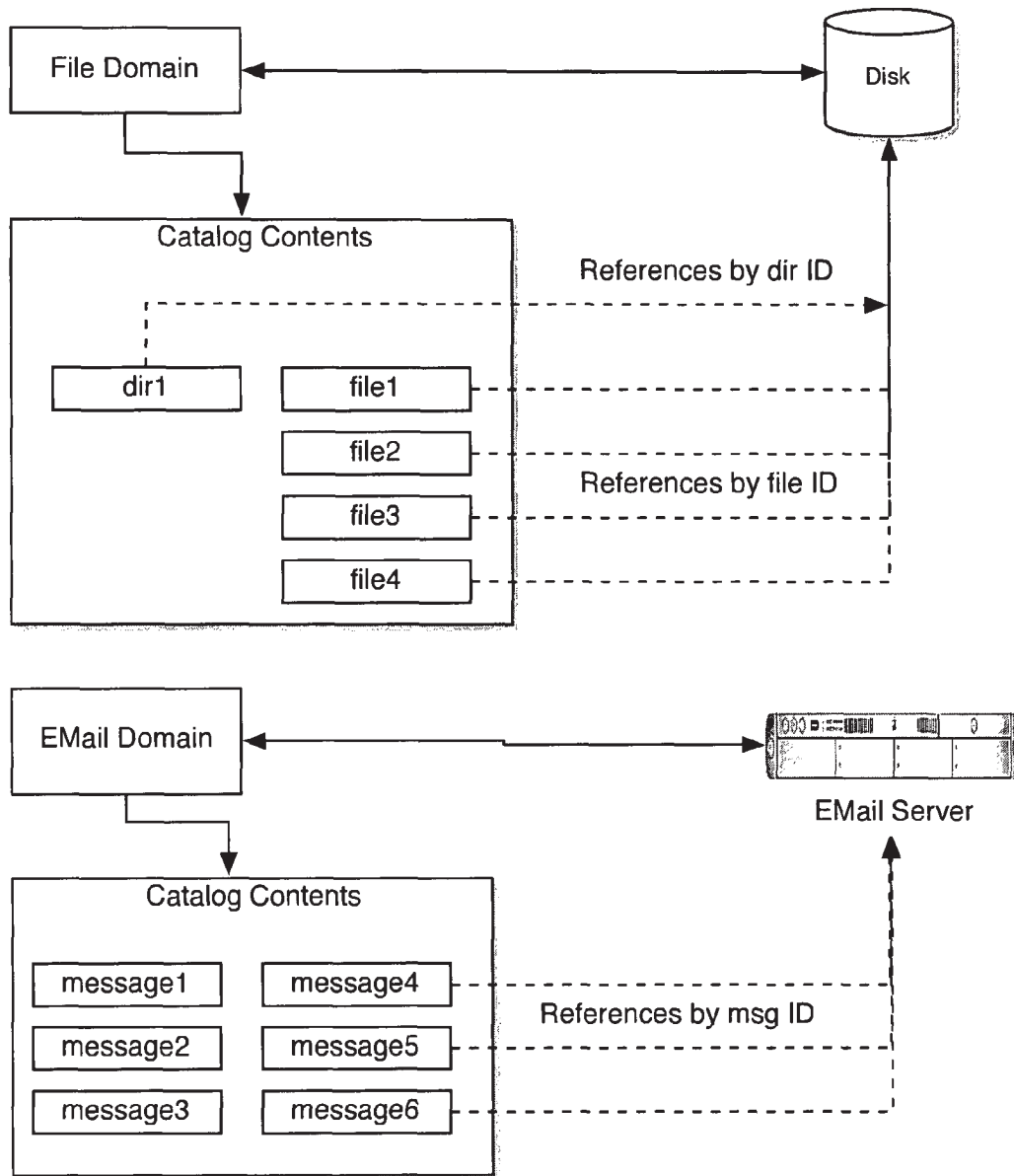

Figure 2

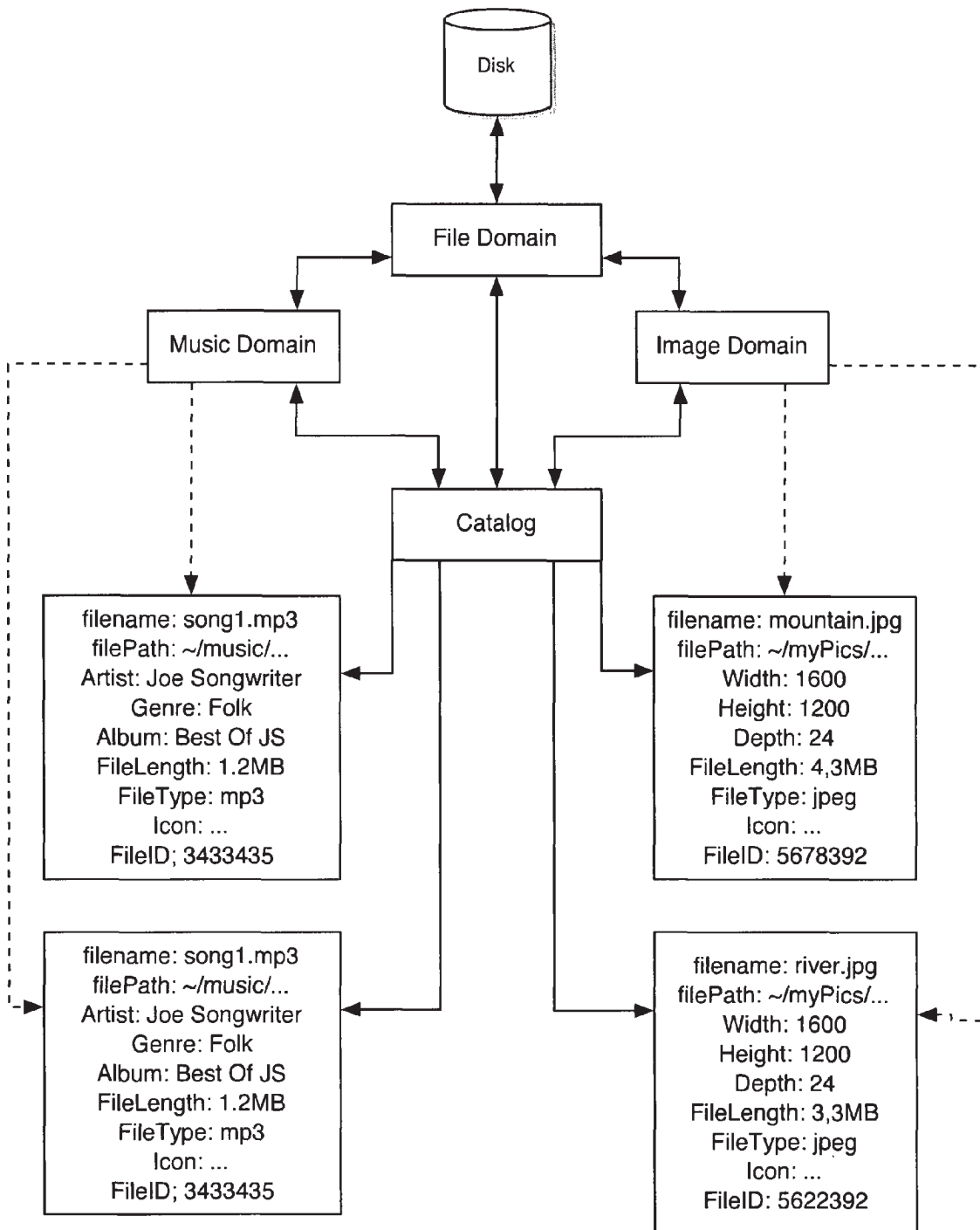

Figure 3

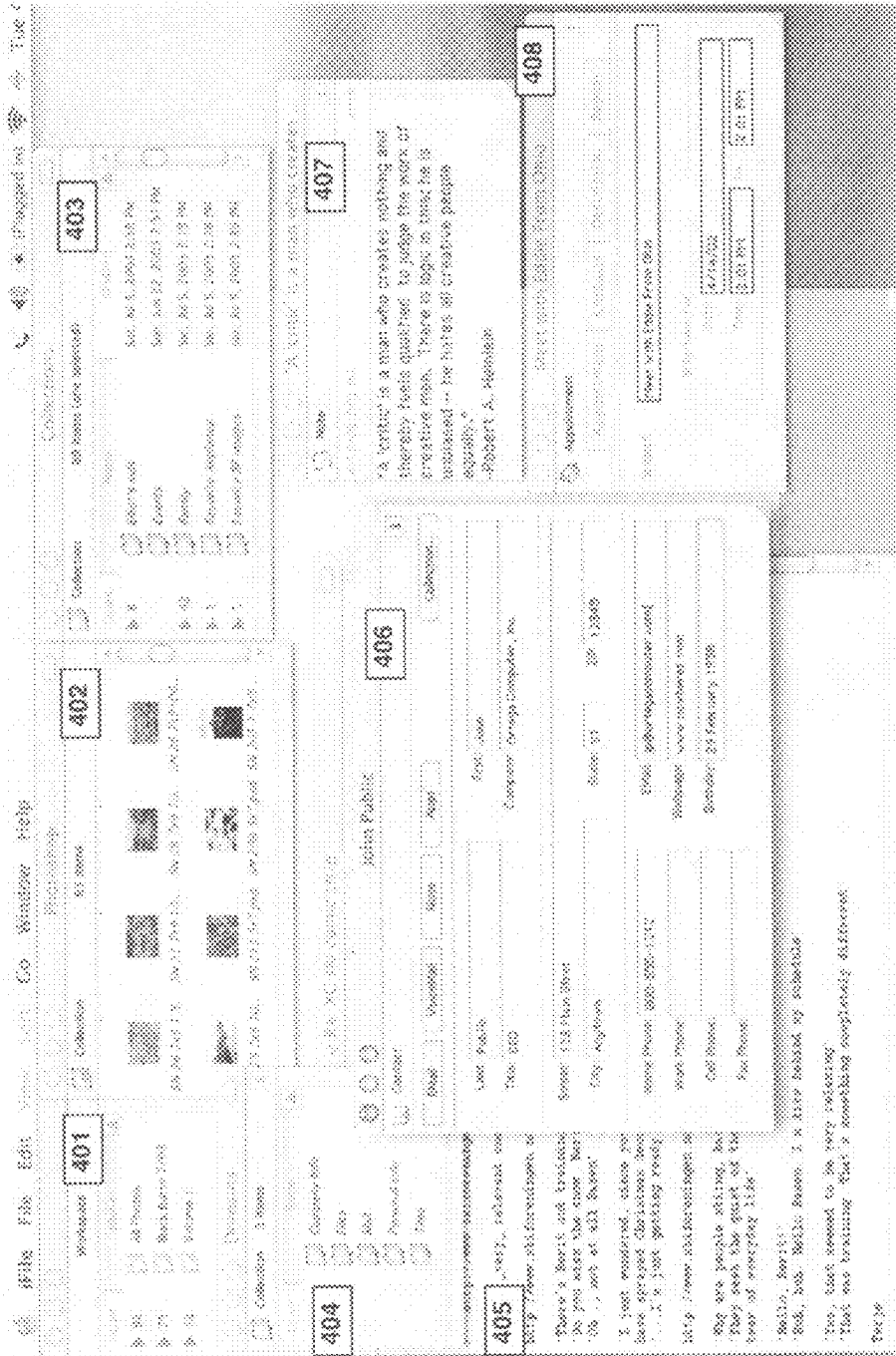

Figure 4

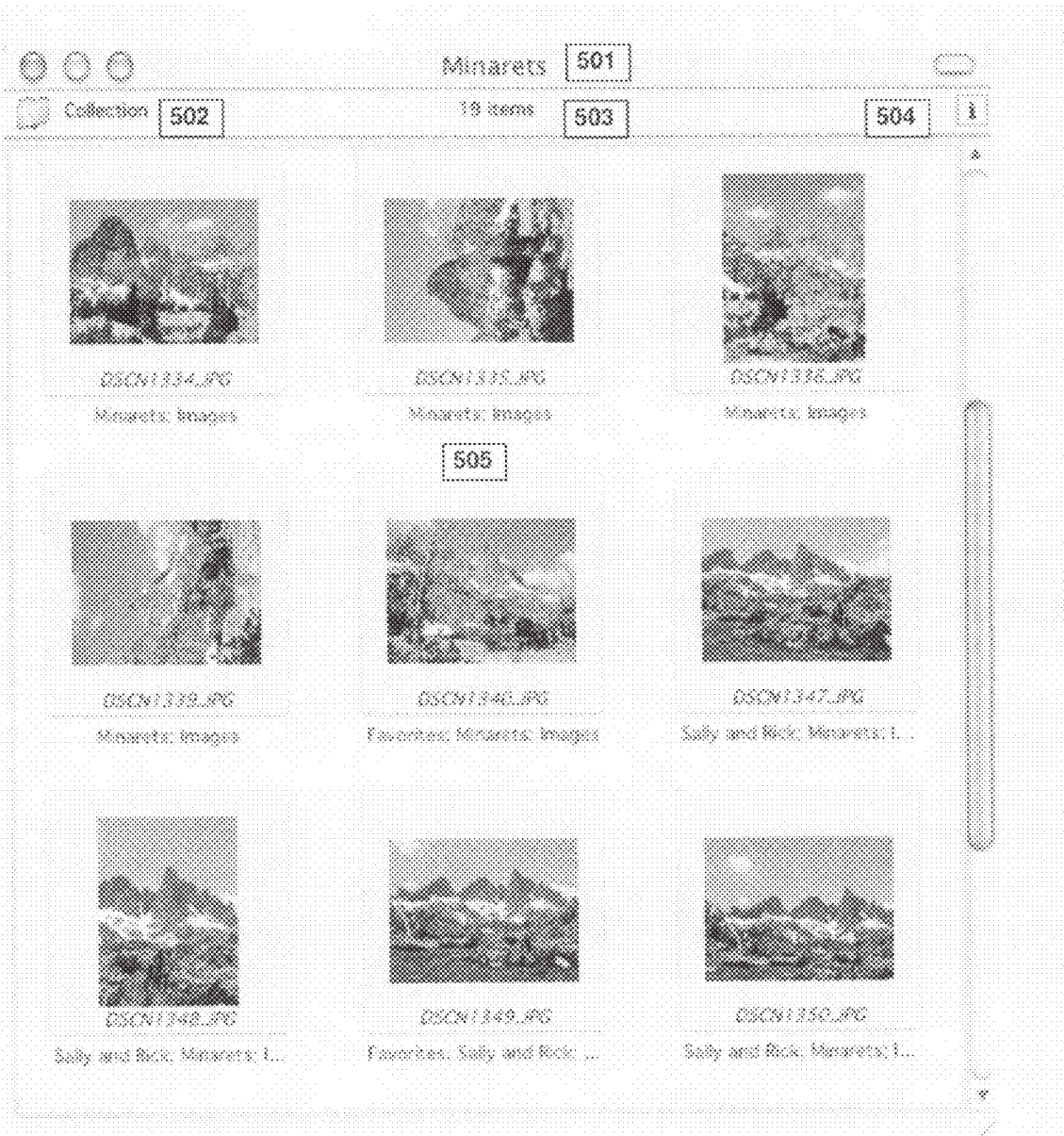

Figure 5

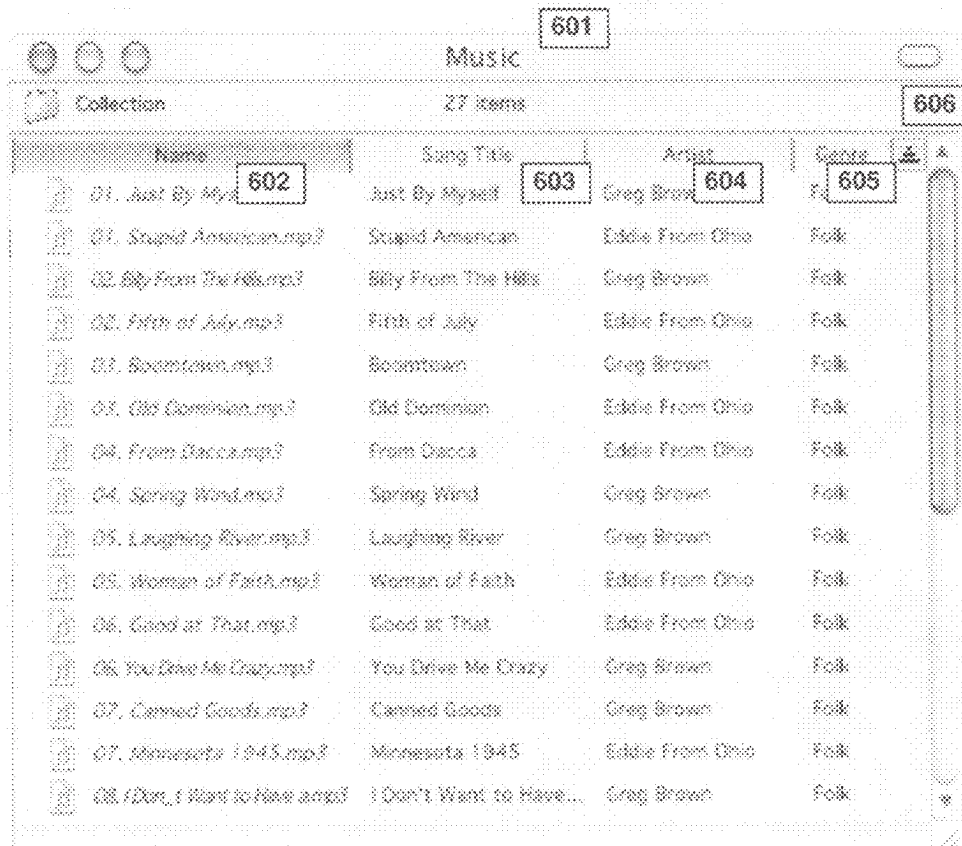

Figure 6



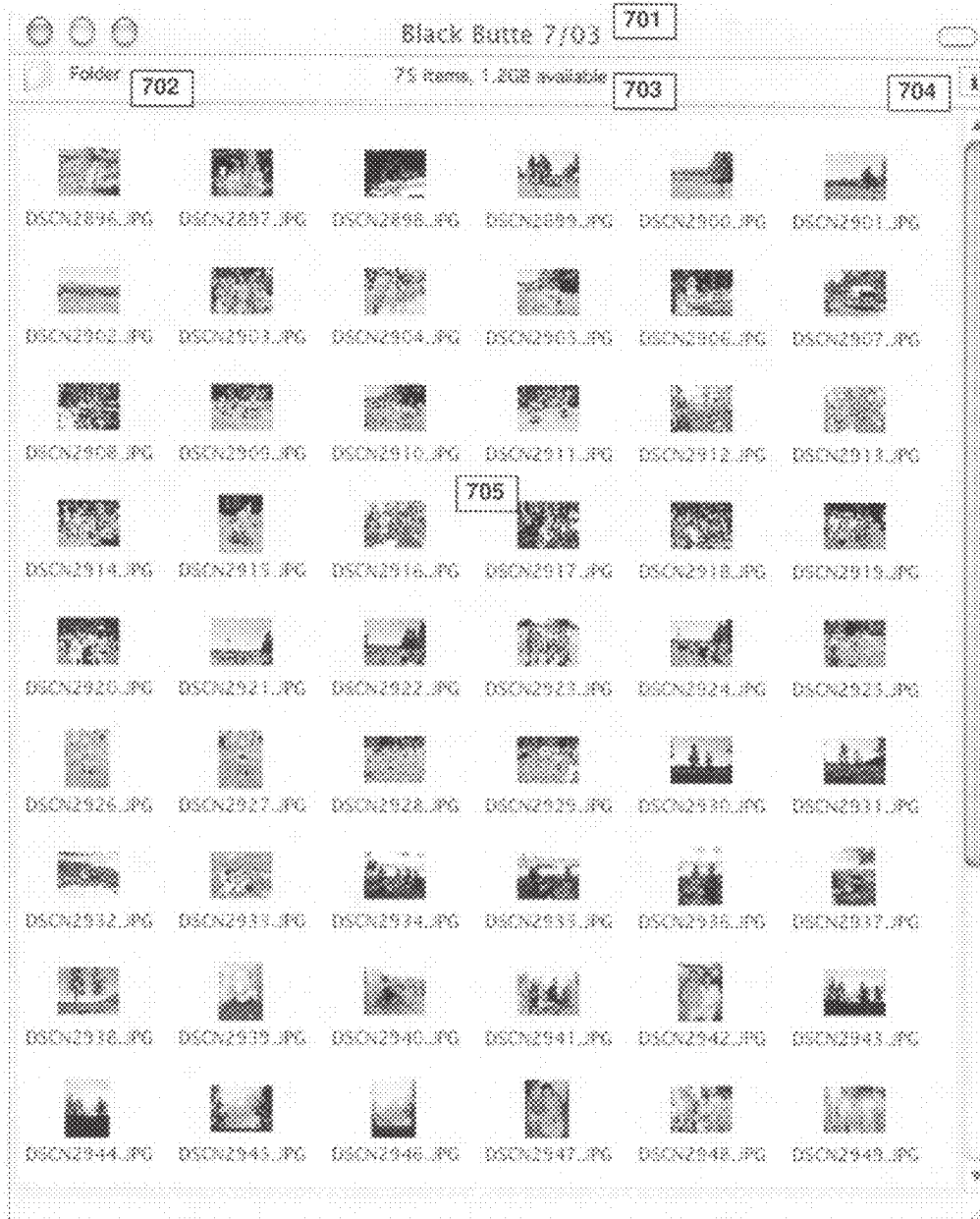

Figure 7a

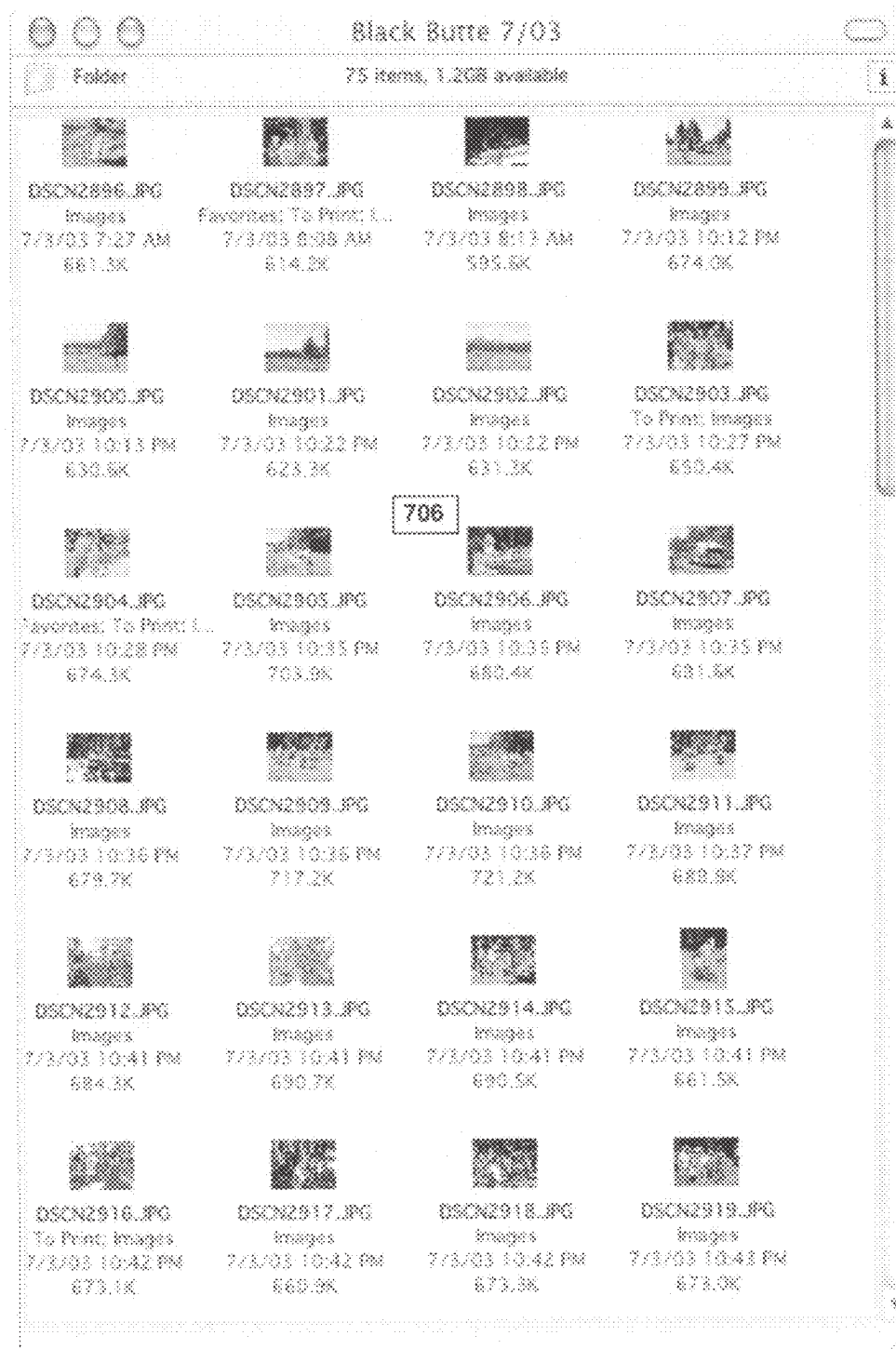

Figure 7b

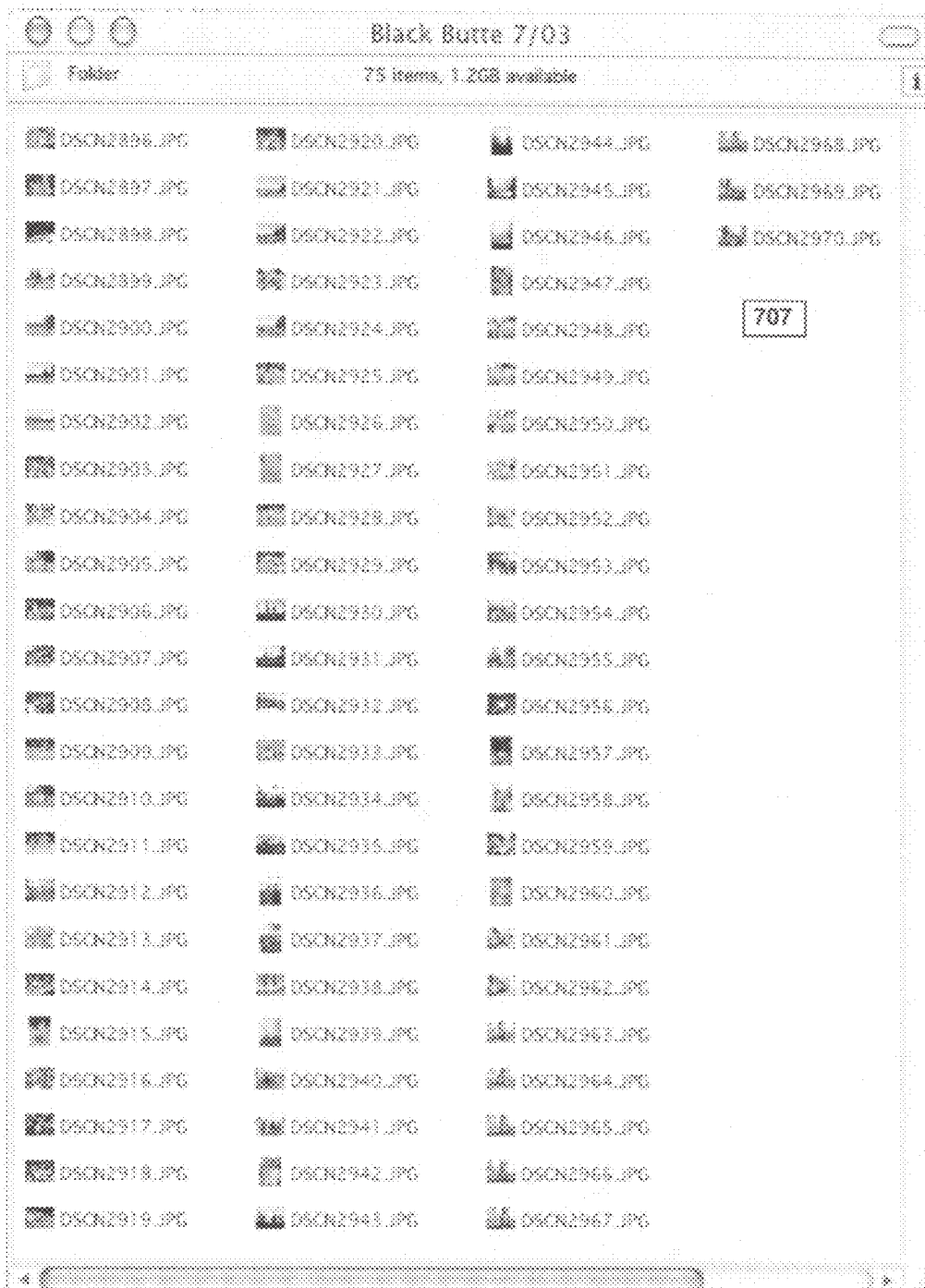

Figure 7c

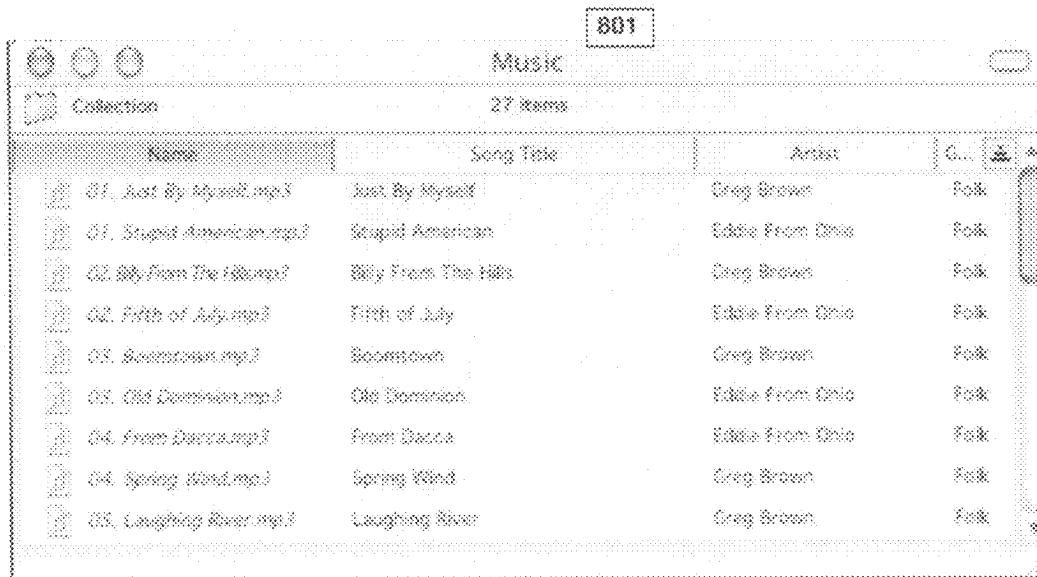

Figure 8



Figure 9a



Figure 10a

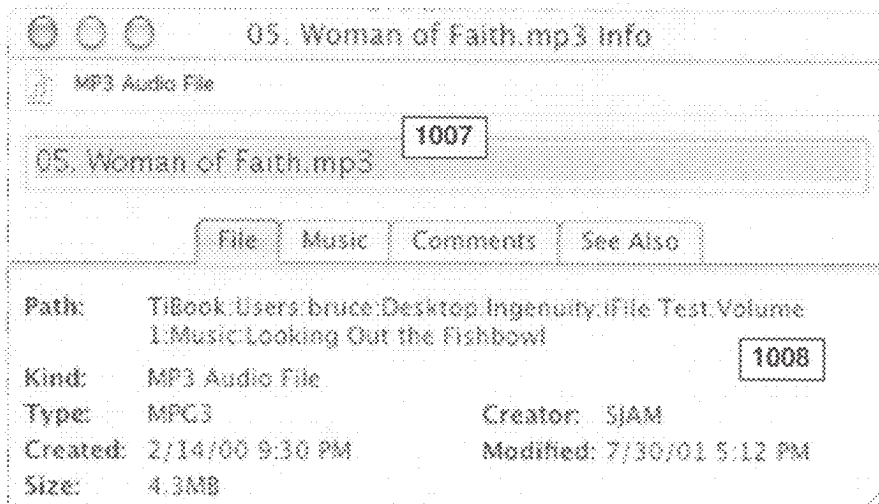

Figure 10b

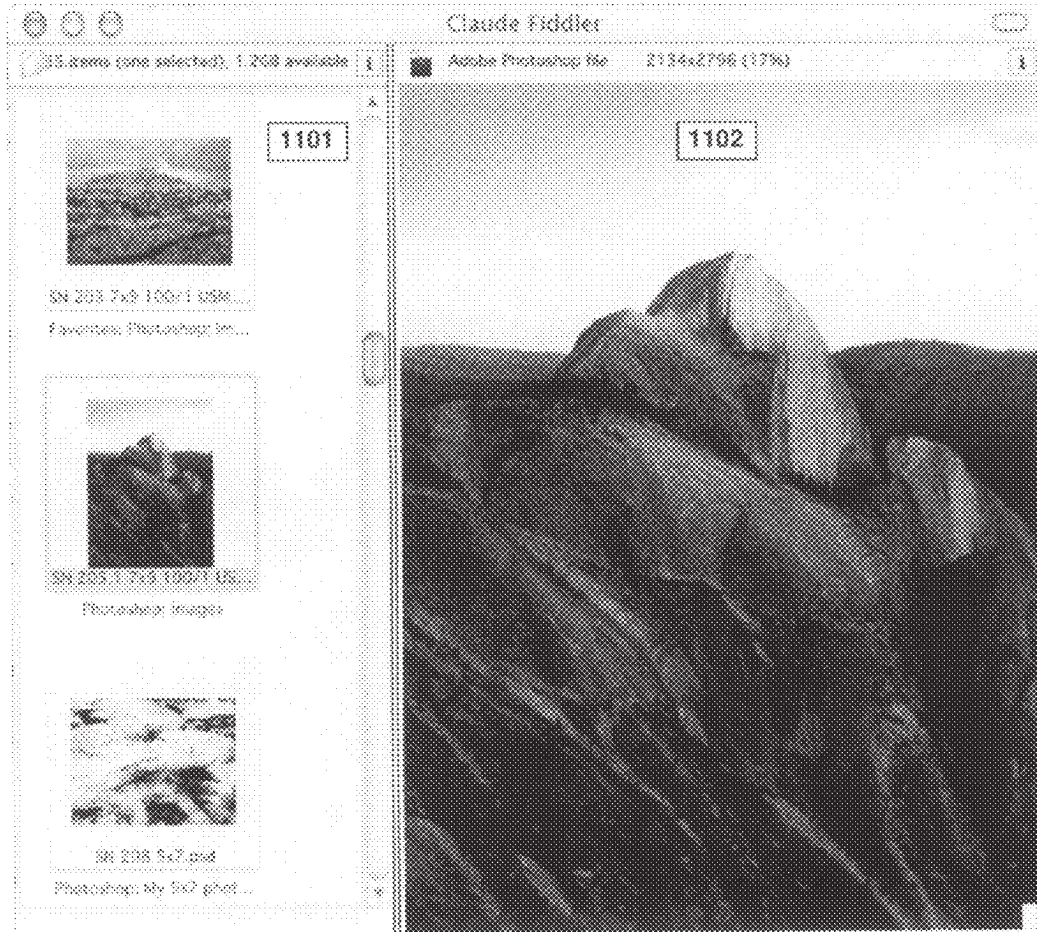

Figure 11a



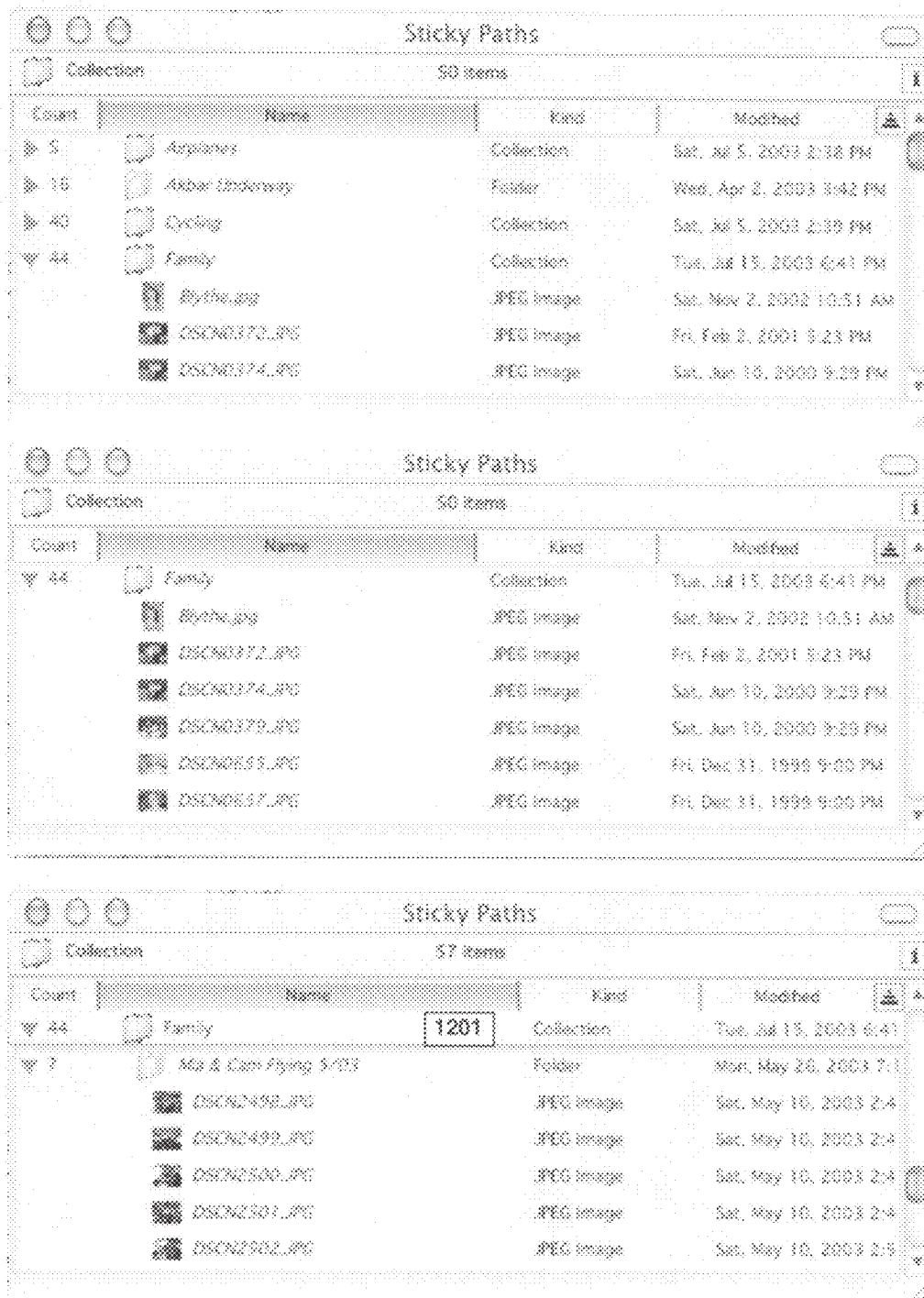

Figure 12a

Sticky Paths

Collection 57 items

Count	Name	Kind	Modified
44	Family	Collection	Tue, Jul 15, 2003 6:41
7	Mia & Cam Flying 5/03	Folder	Mon, May 26, 2003 7:1
	DSCN2303.JPG	JPEG image	Sat, May 10, 2003 2:5
	DSCN2304.JPG	JPEG image	Sat, May 10, 2003 2:5
110	Mia, Cam & Chloe 5/03	Folder	Fri, Jun 27, 2003 11:1
	Mom	JPEG image	Sat, Feb 10, 2001 6:24
	Mom 2	JPEG image	Sat, Feb 10, 2001 6:24

Sticky Paths

Collection 167 items

Count	Name	Kind	Modified
44	Family	Collection	Tue, Jul 15, 2003 6:41
110	Mia, Cam & Chloe 5/03	Folder	Fri, Jun 27, 2003 11:11
	DSCN0004.JPG	JPEG image	Sun, Apr 20, 2003 1:1
	DSCN0006.JPG	JPEG image	Sun, Apr 20, 2003 4:4
	DSCN0007.JPG	JPEG image	Sun, Apr 20, 2003 4:4
	DSCN0008.JPG	JPEG image	Sun, Apr 20, 2003 5:1
	DSCN0009.JPG	JPEG image	Sun, Apr 20, 2003 5:1

Sticky Paths

Collection 167 items

Count	Name	Kind	Modified
44	Family	Collection	Tue, Jul 15, 2003 6:41
	Mom 3	JPEG image	Sat, Feb 10, 2001 6:24
	Mom At Braselones.JPG	JPEG image	Mon, May 21, 2001 9:7
	MomAtCheckered.JPG	JPEG image	Tue, May 22, 2001 10
	Sam at Hong Ten	JPEG image	Fri, Jul 27, 2001 9:03
48	Financial	Collection	Mon, Jul 14, 2003 9:37
57	Mammoth	Collection	Mon, Jul 14, 2003 9:37

Figure 12b

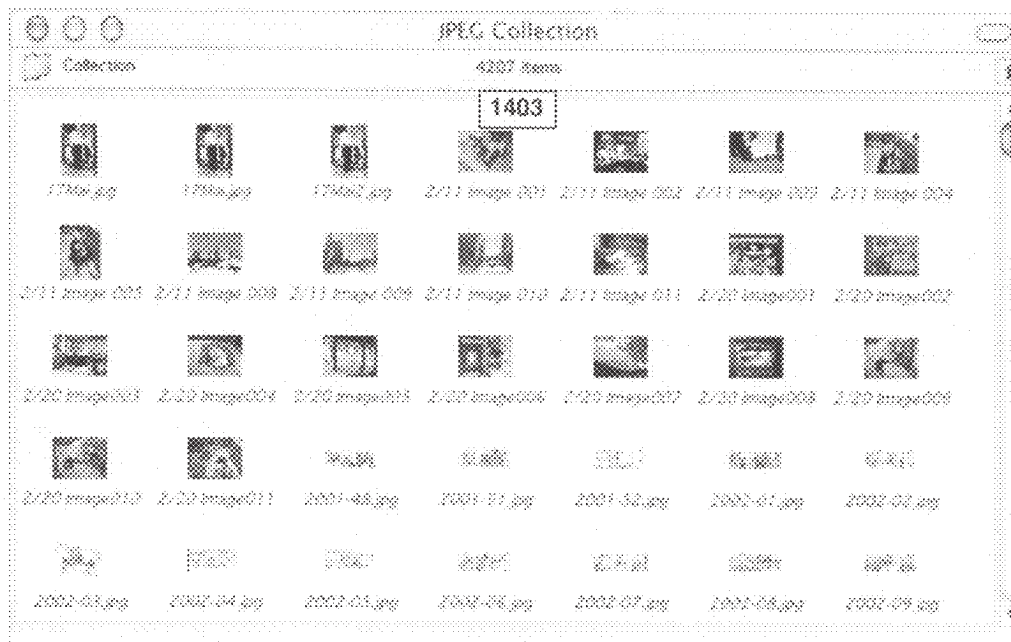
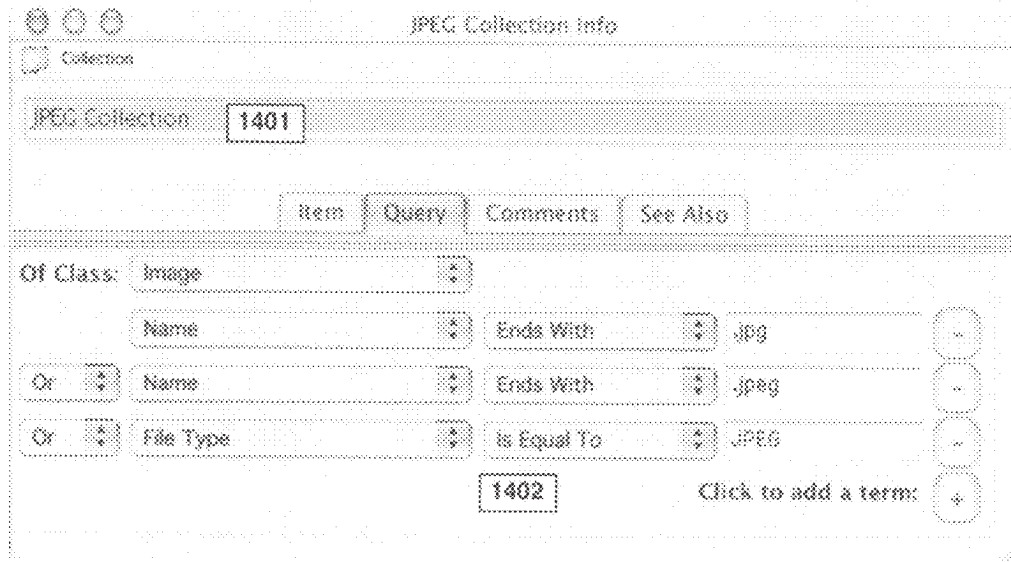

Figure 14

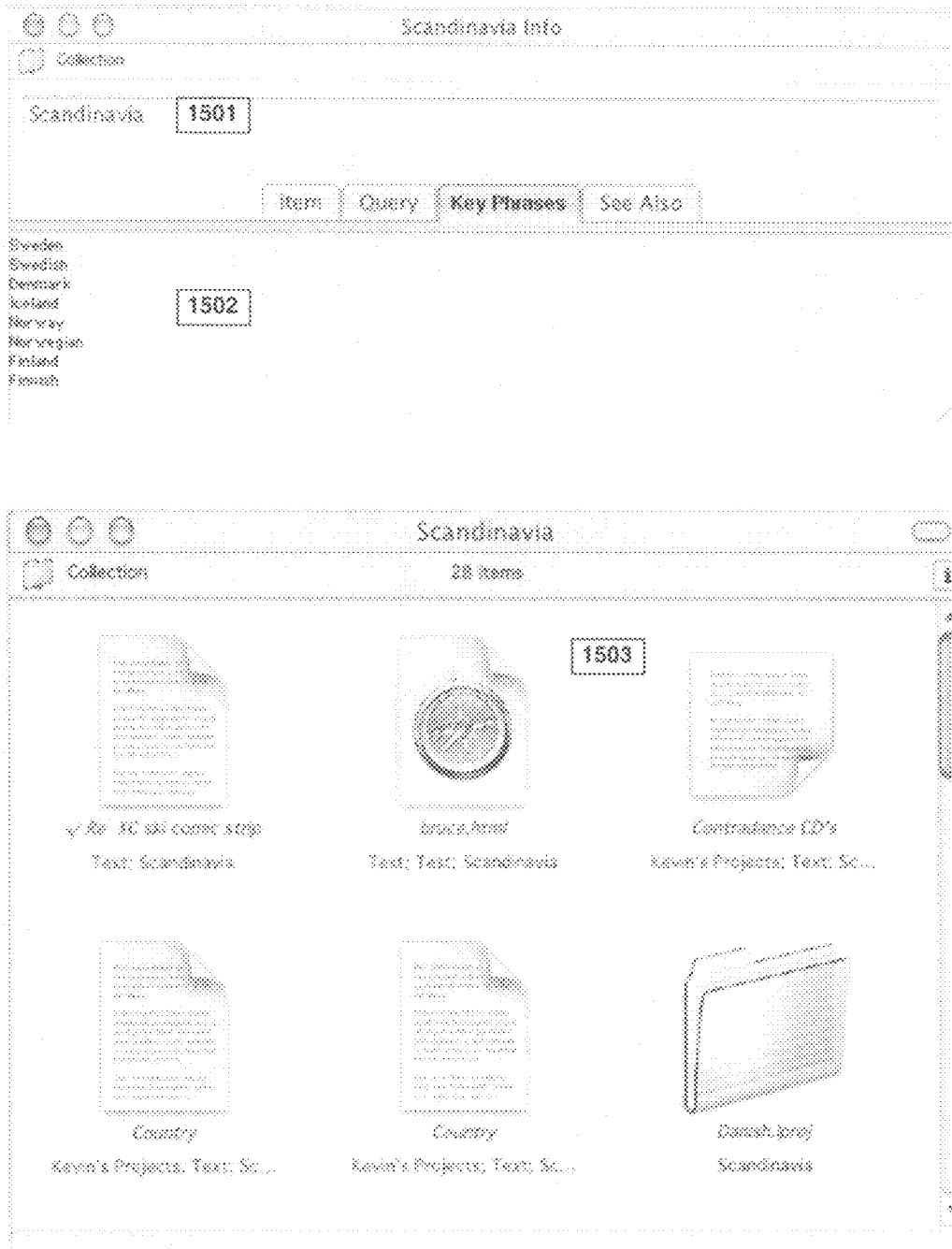

Figure 15

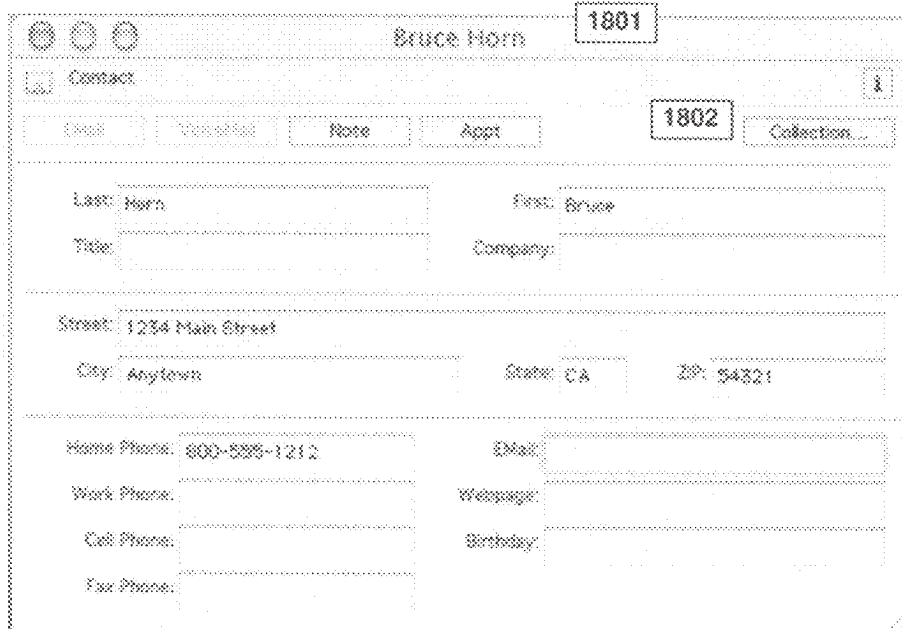

Figure 18

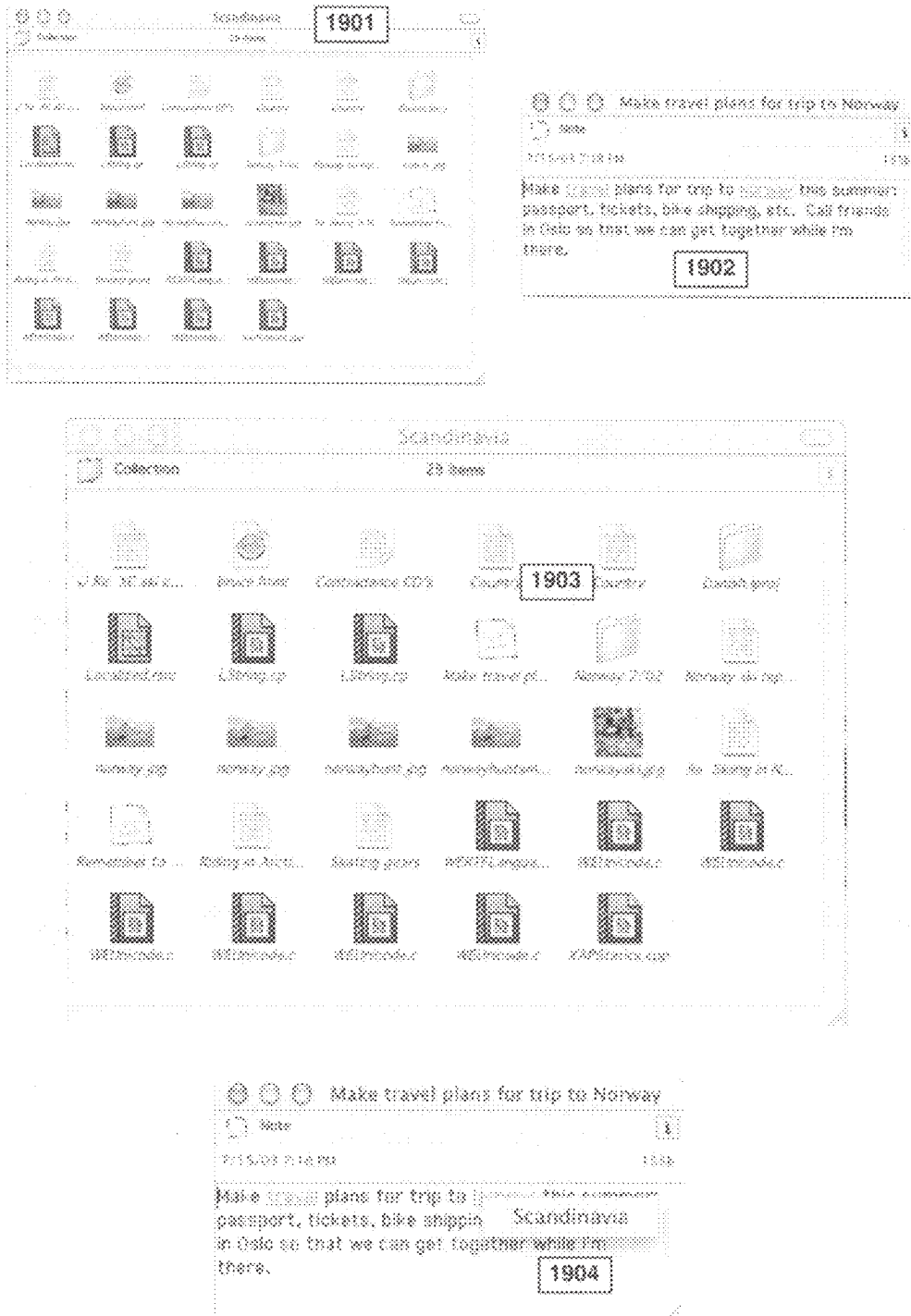

Figure 19

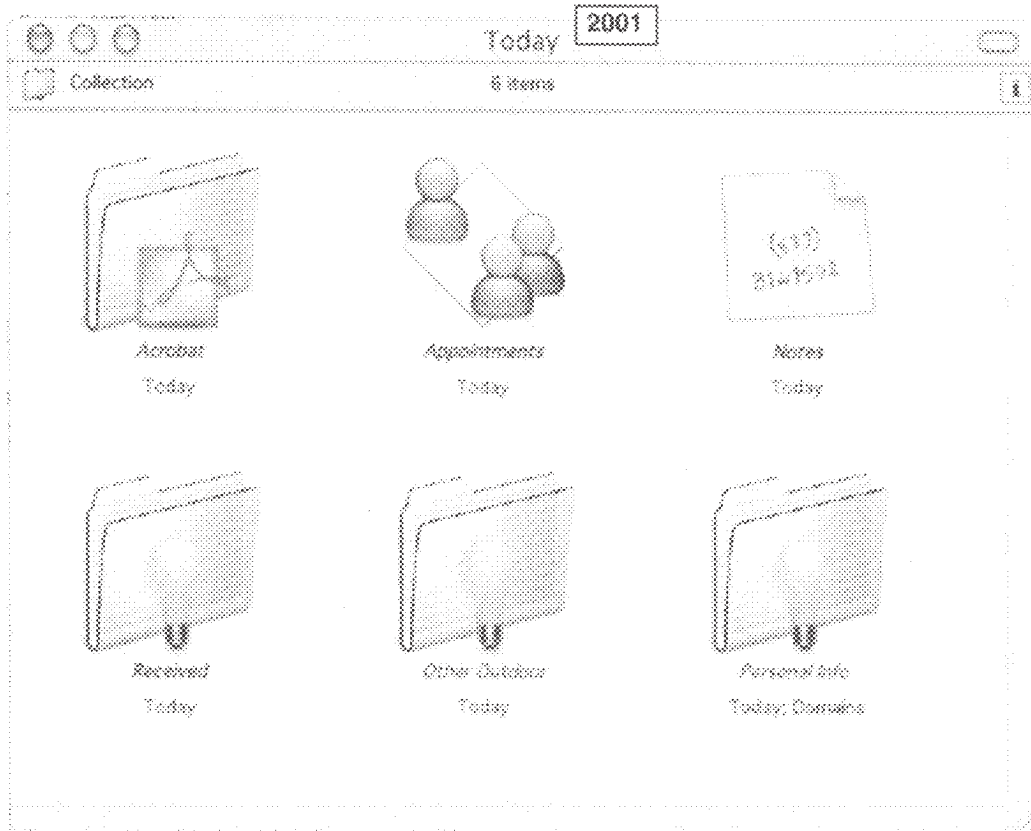

Figure 20

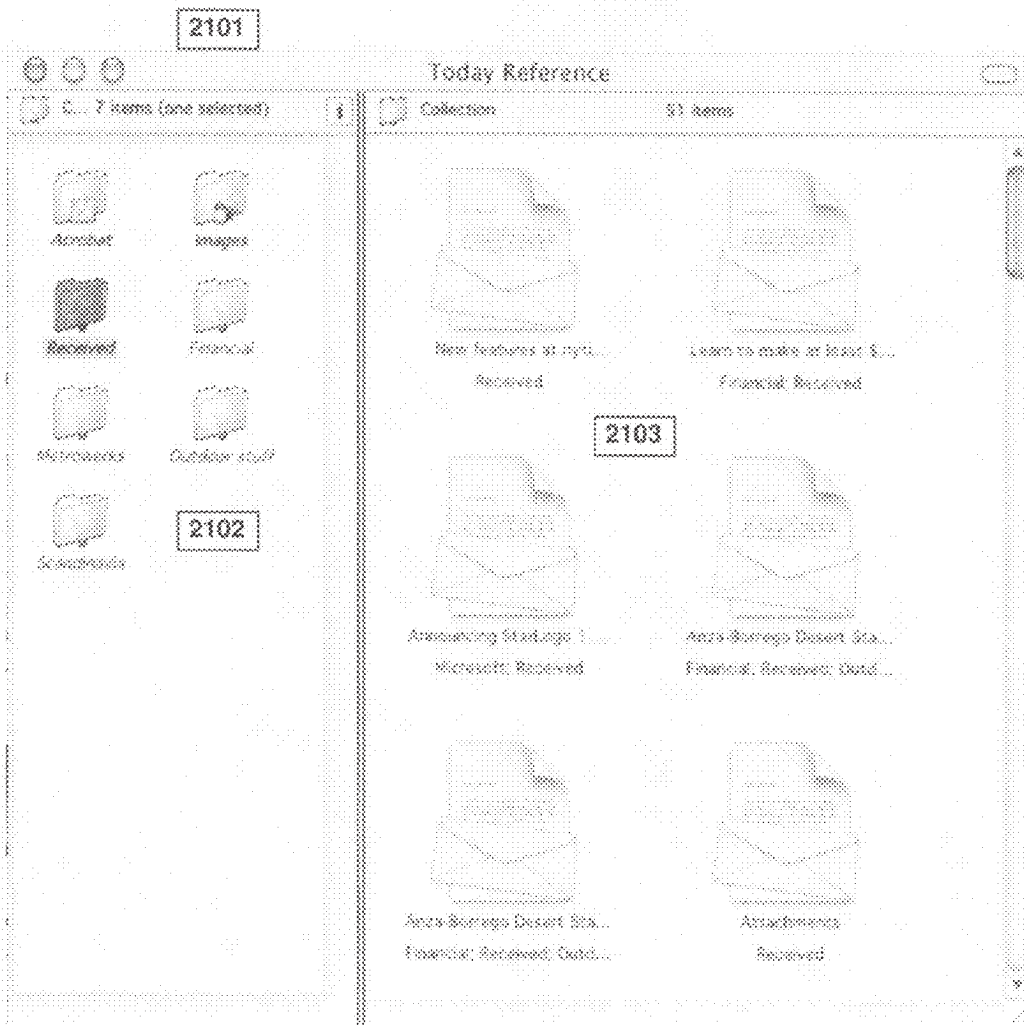

Figure 21



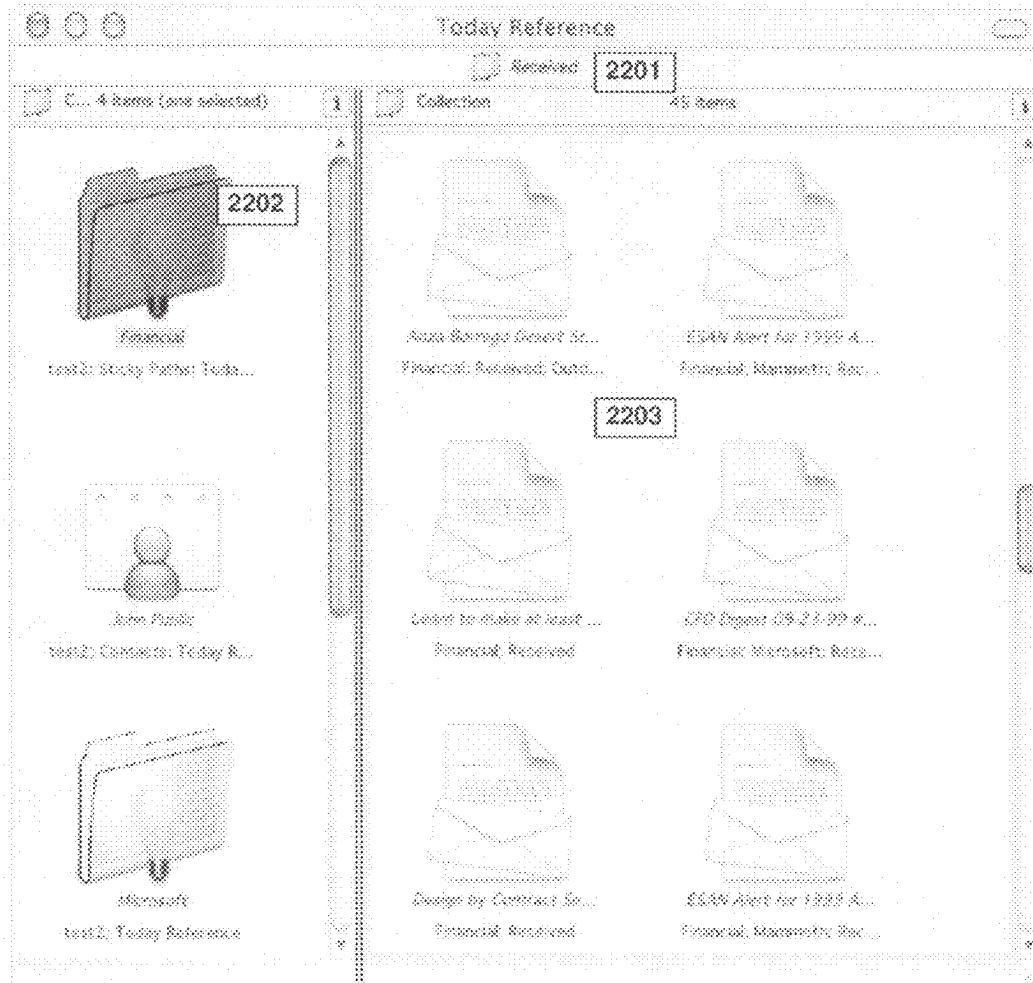

Figure 22

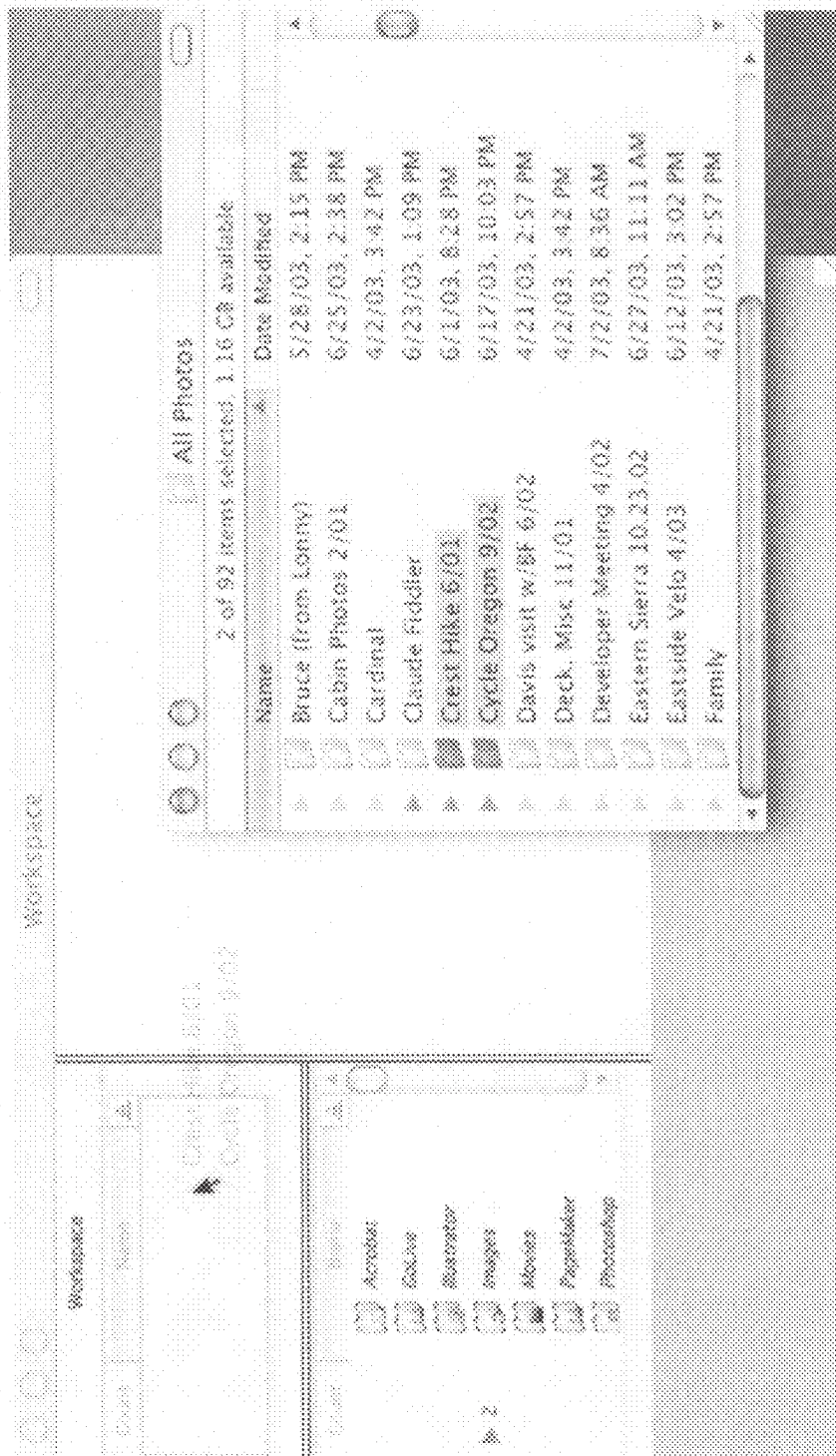

Figure 24

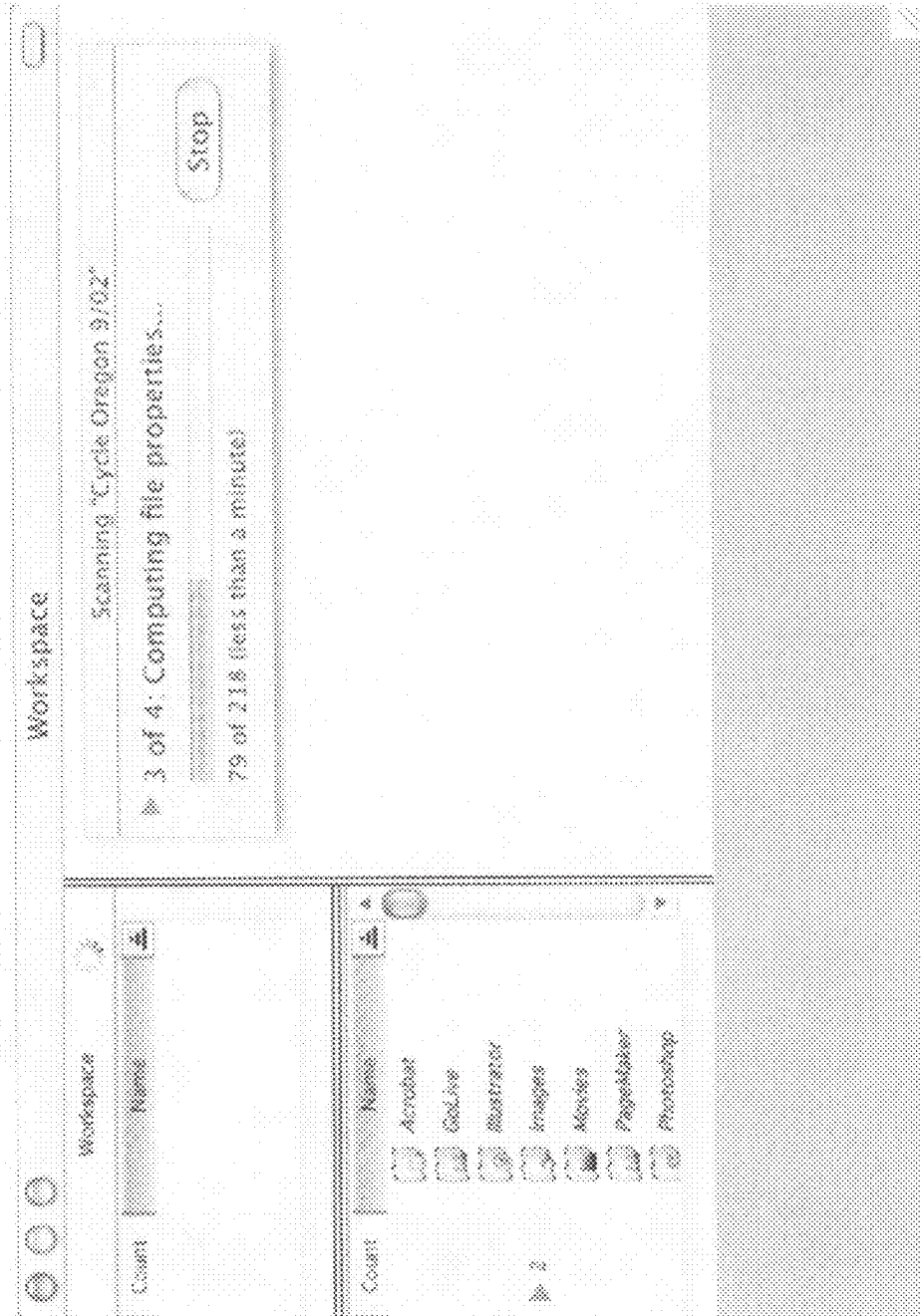

Figure 25a

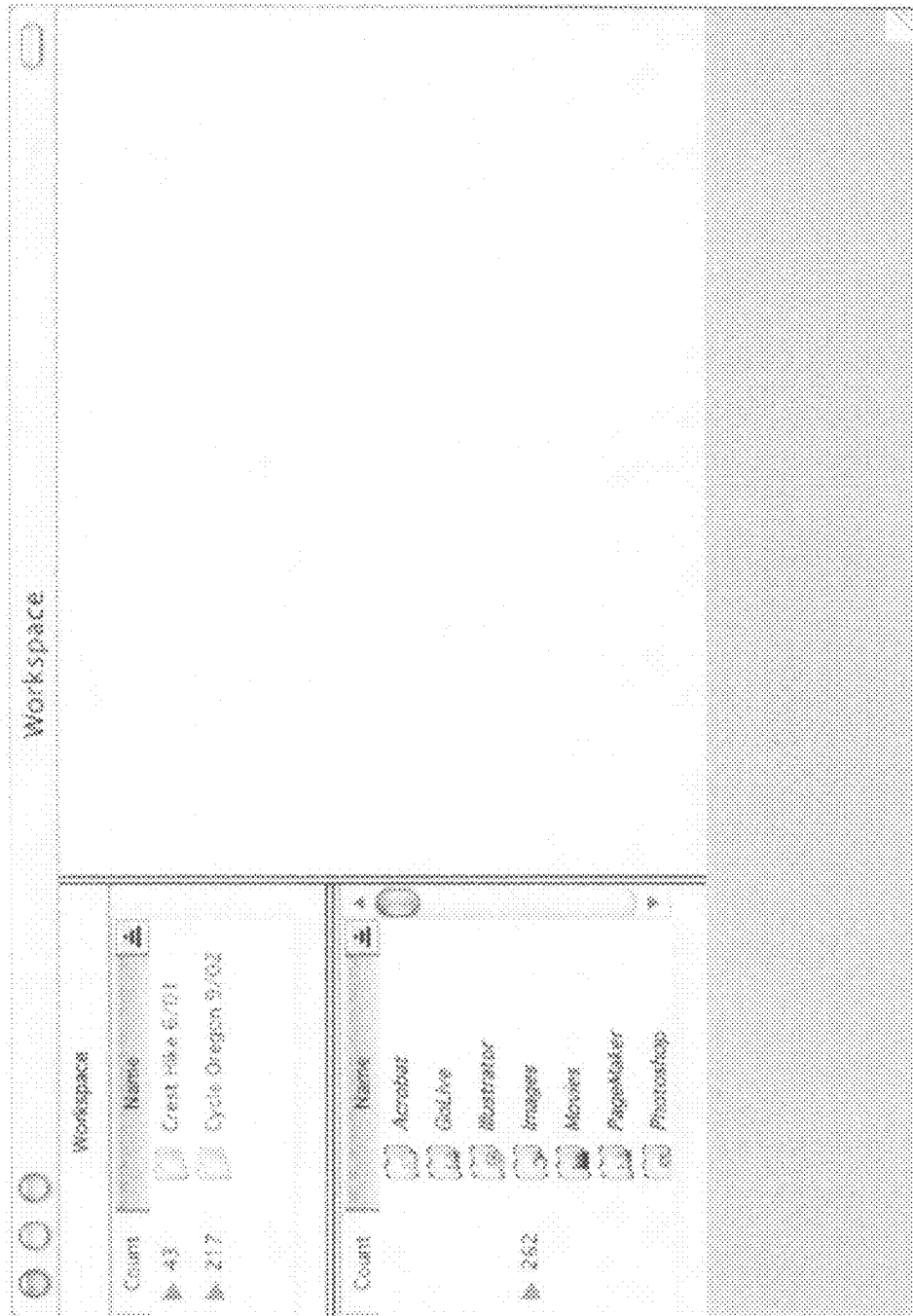

Figure 25b

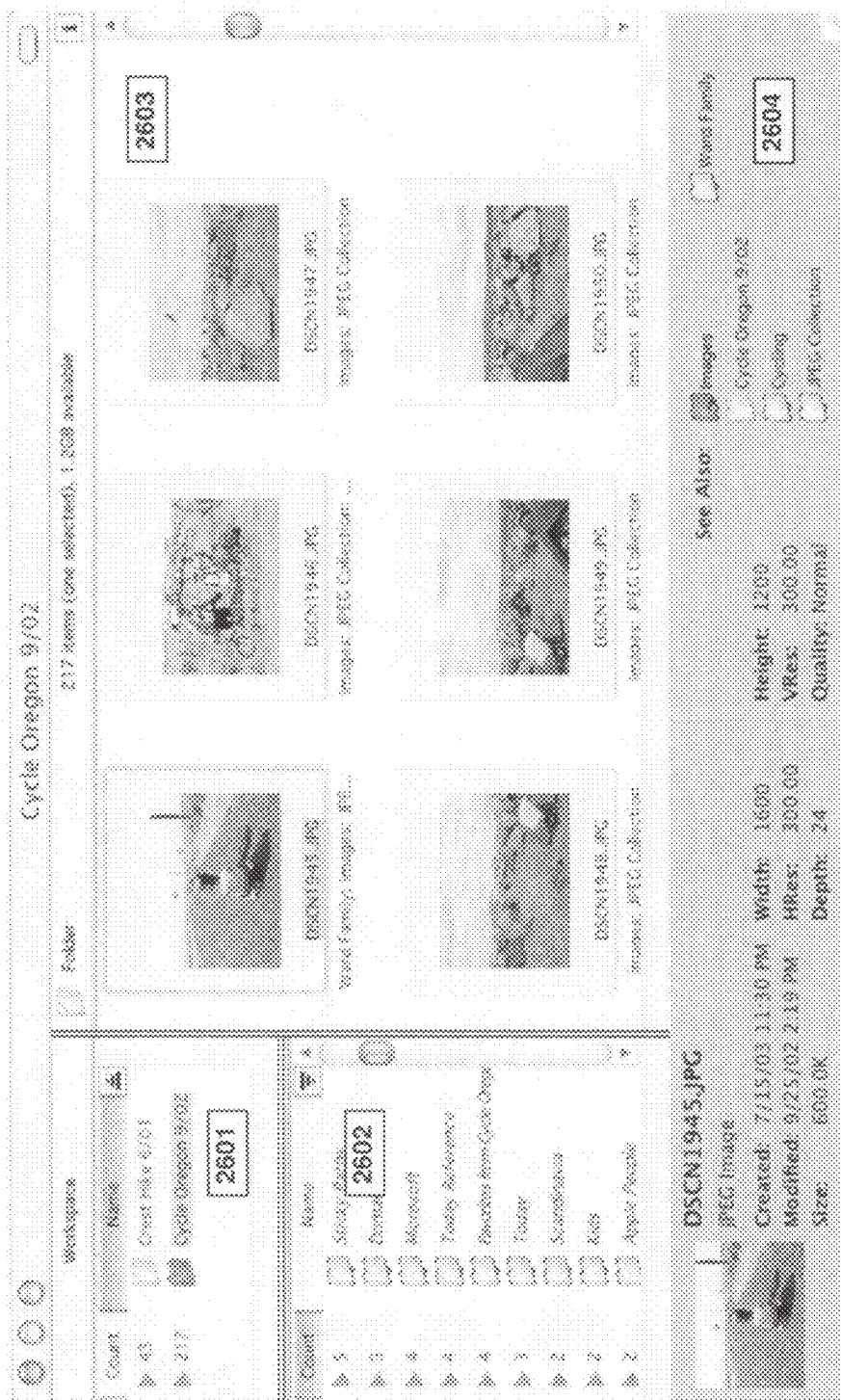

Figure 26



Figure 27

2901



2902



2903

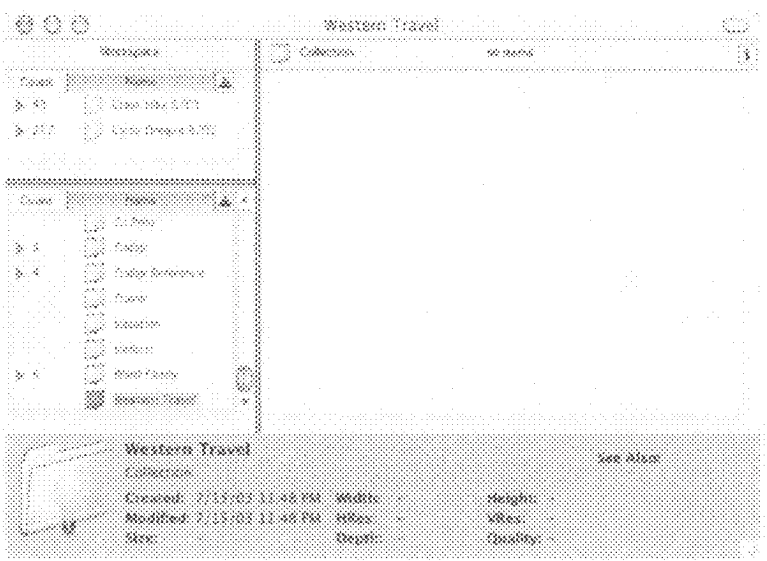

Figure 29



Figure 30



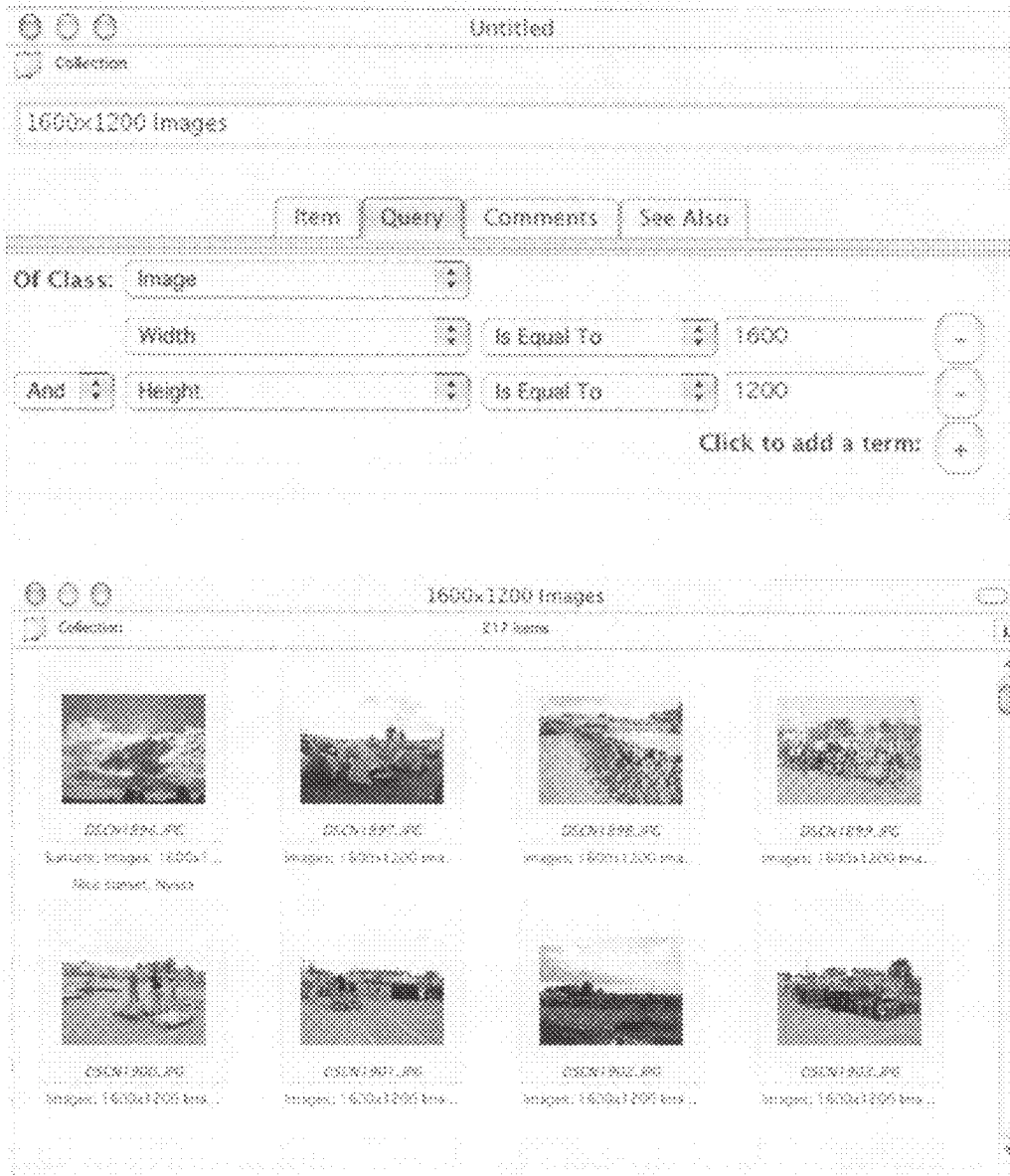

Figure 31

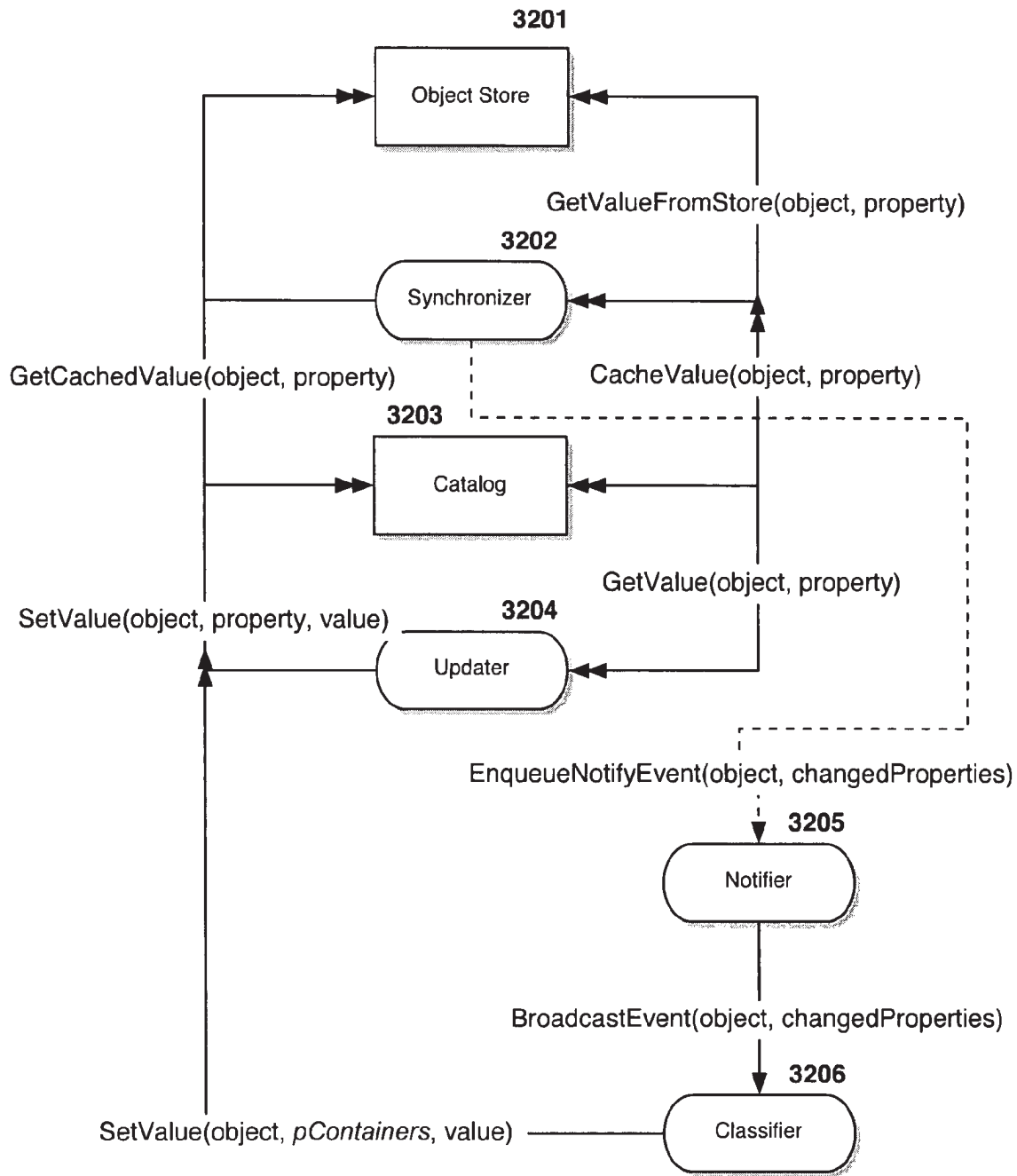

Figure 32

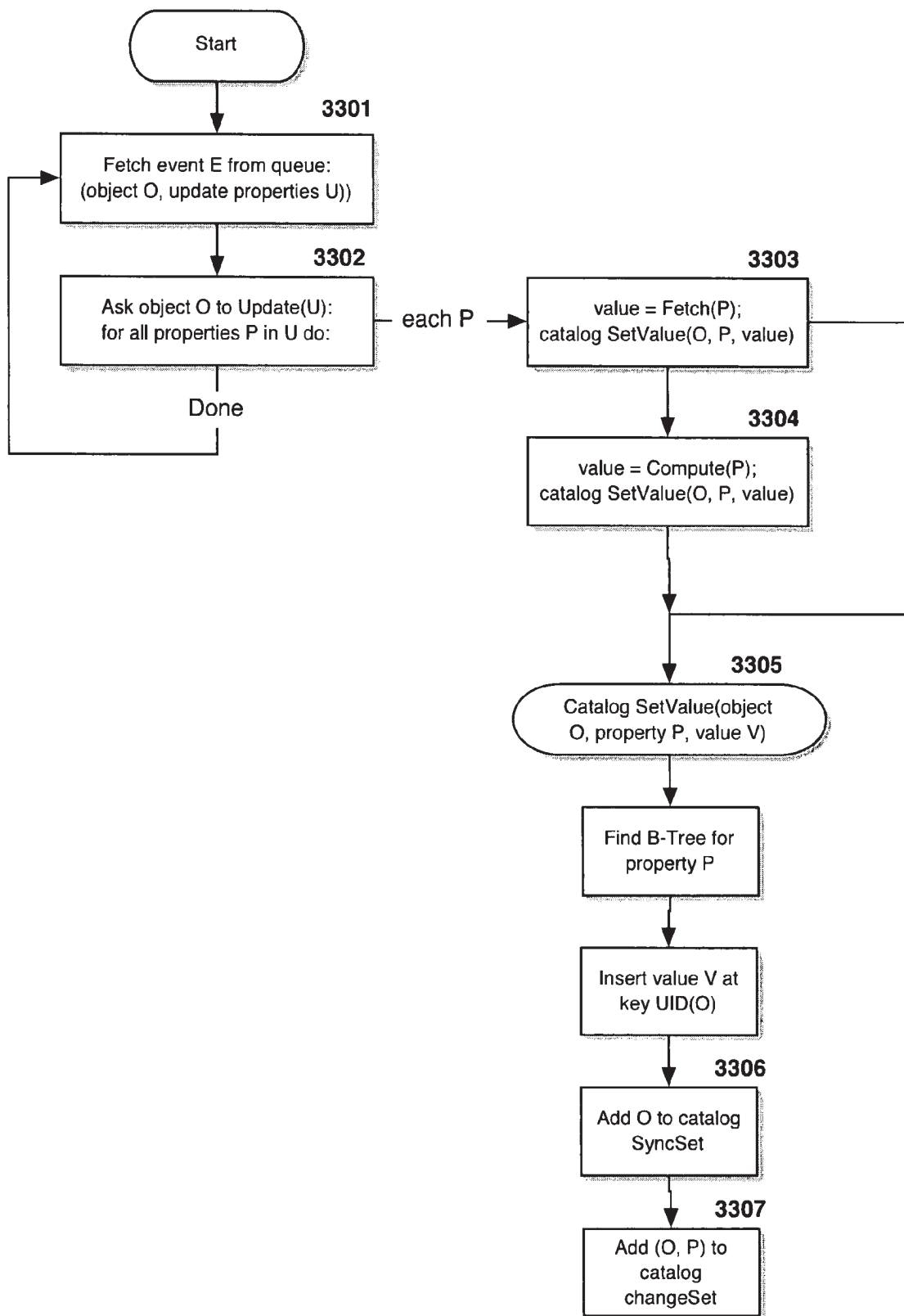

Figure 33

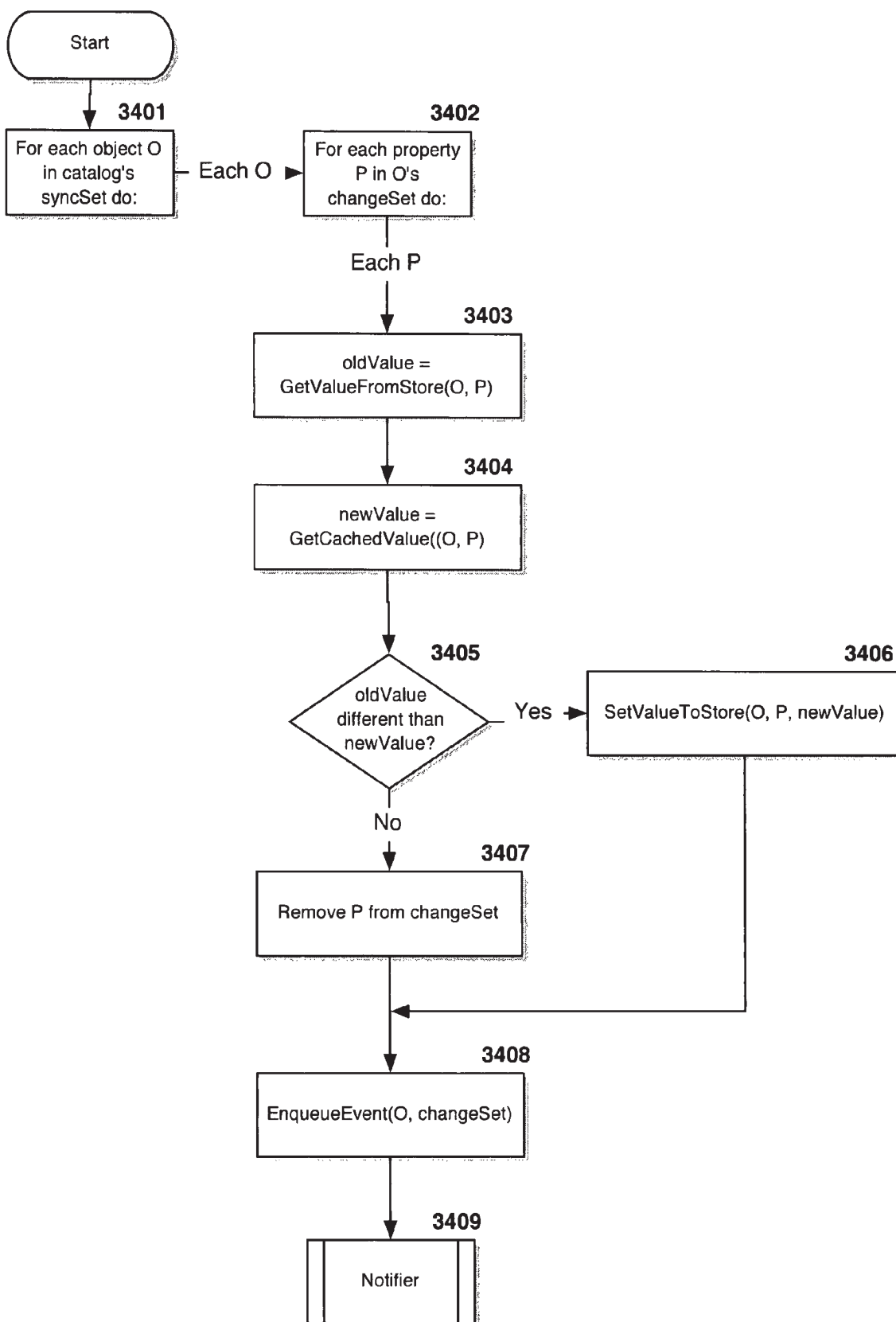

Figure 34

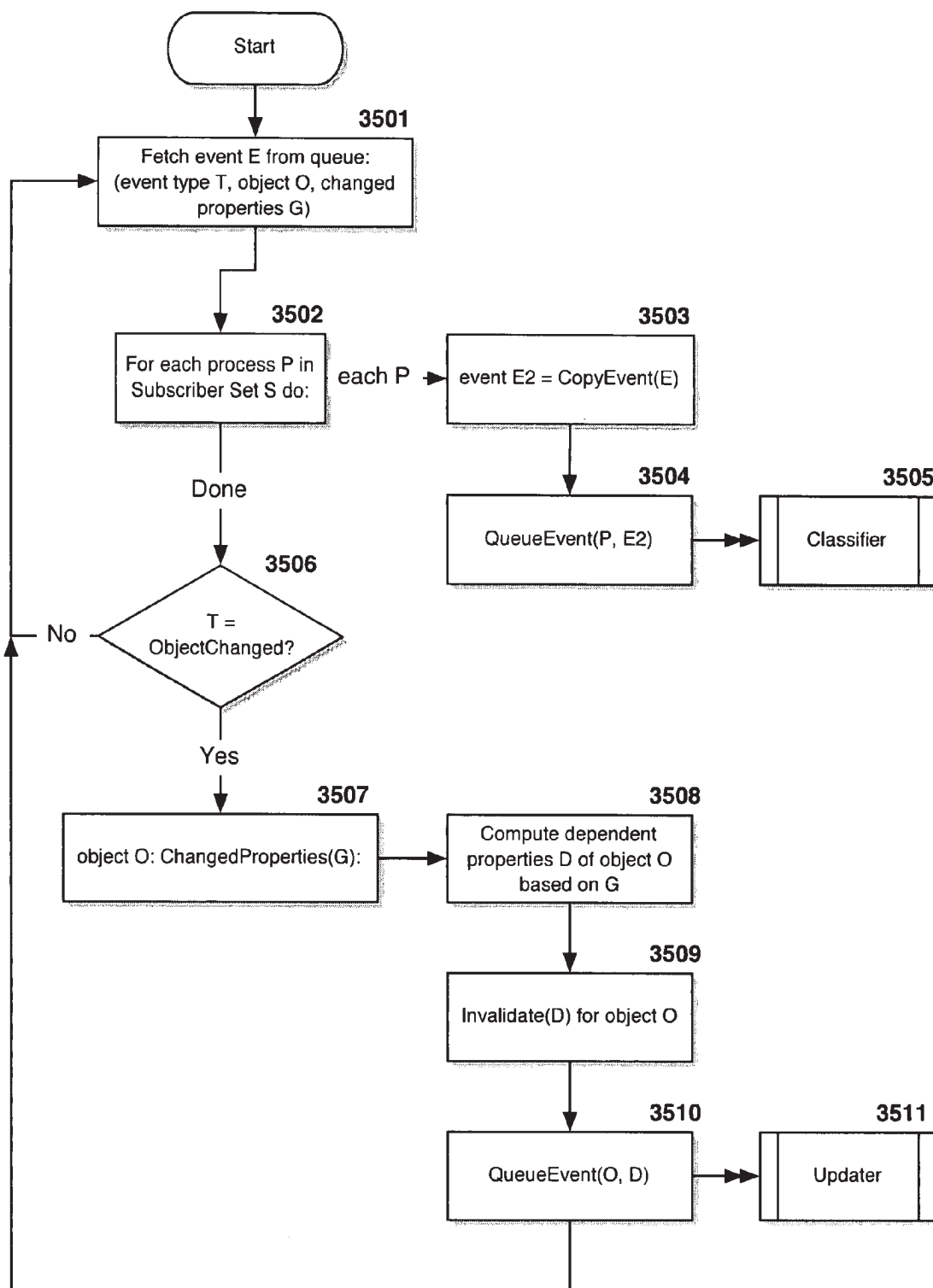

Figure 35

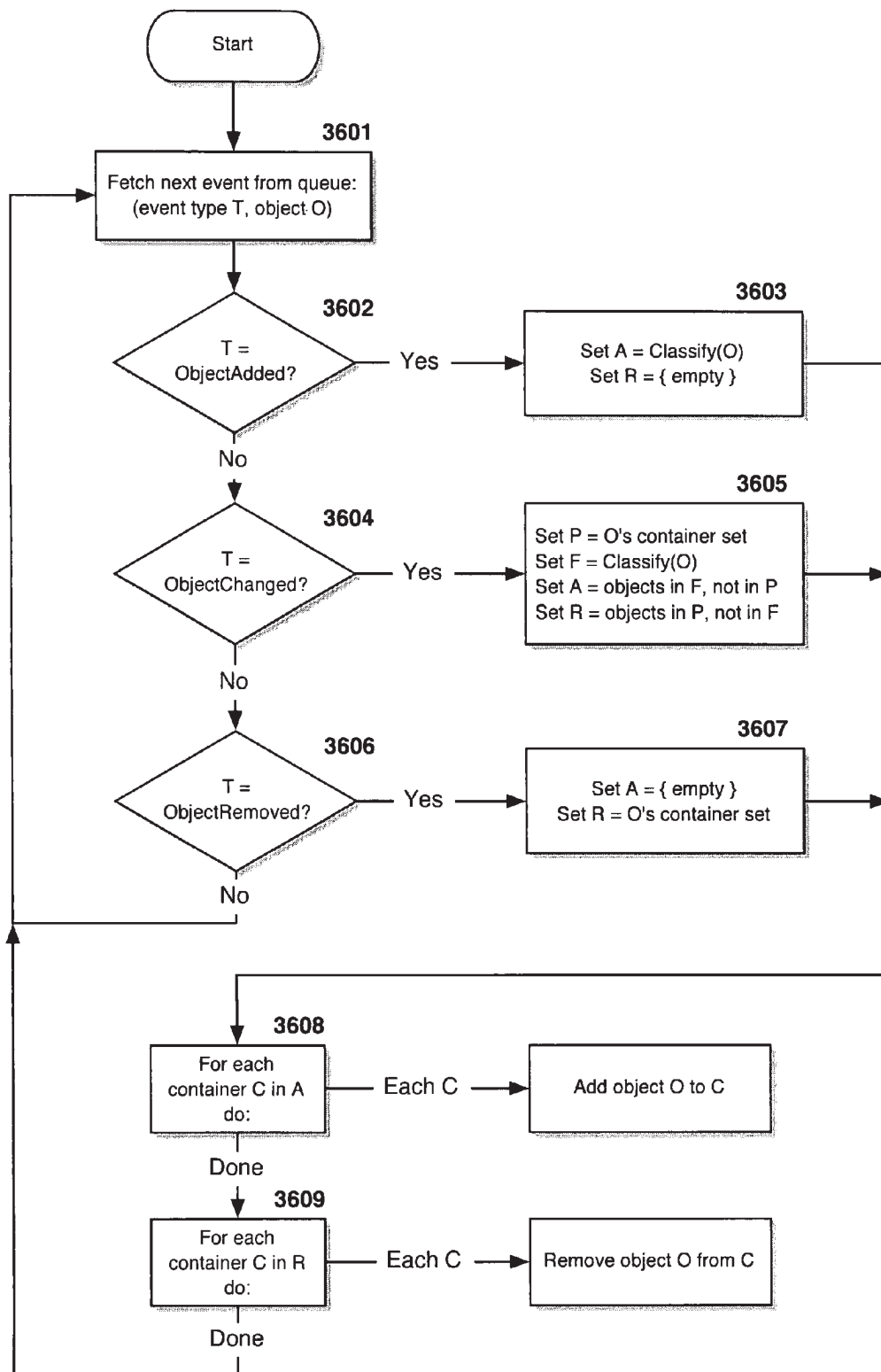

Figure 36

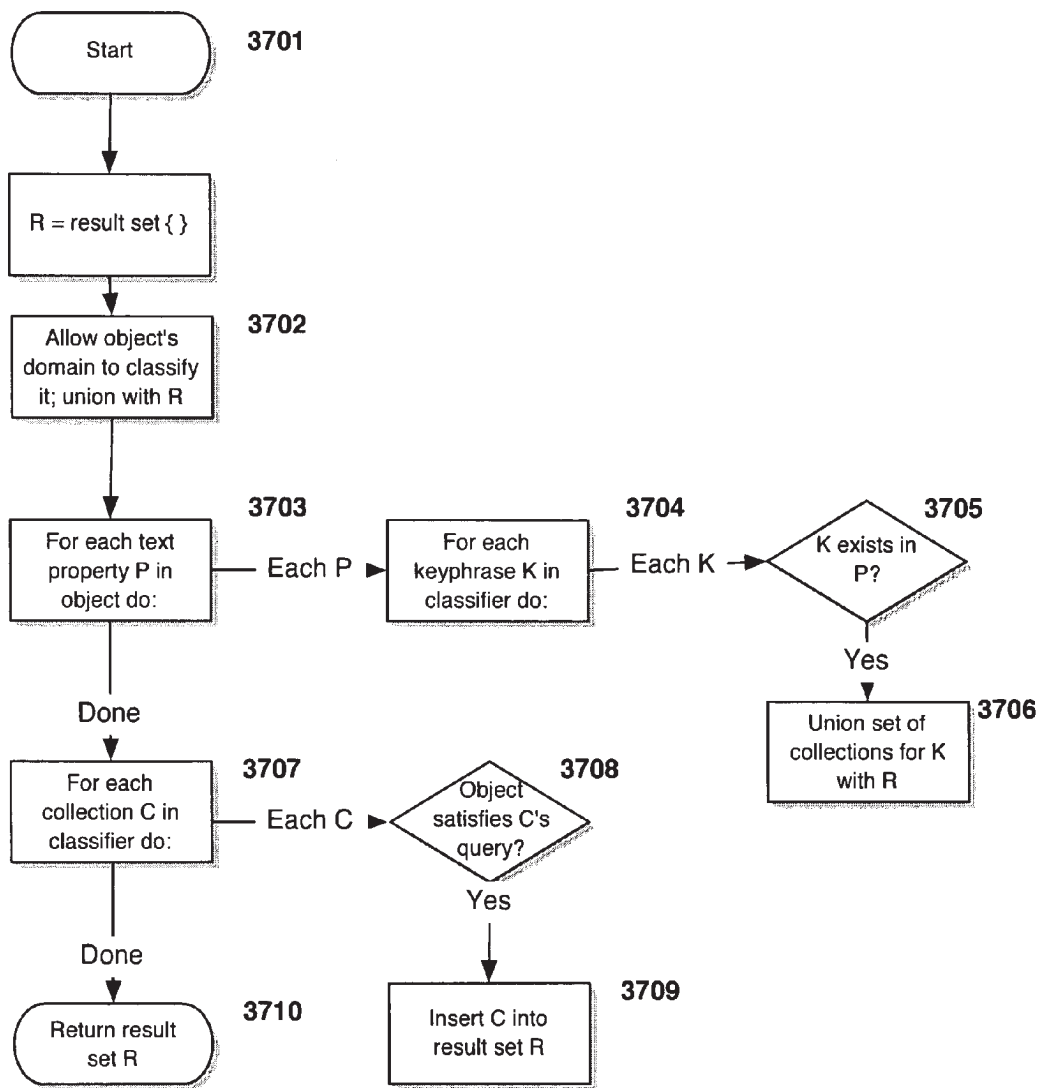

Figure 37