

# EXHIBIT J



US007100185B2

(12) **United States Patent**  
**Bennington et al.**

(10) **Patent No.:** **US 7,100,185 B2**  
(45) **Date of Patent:** **Aug. 29, 2006**

(54) **ELECTRONIC TELEVISION PROGRAM  
GUIDE SCHEDULE SYSTEM AND METHOD**

FOREIGN PATENT DOCUMENTS

DE 29 18 846 11/1980

(Continued)

(75) Inventors: **Gerald E. Bennington**, Englewood, CO (US); **George Backer**, Highlands Ranch, CO (US); **Shawn Green**, Littleton, CO (US); **Bill Cooper**, Littleton, CO (US); **Dave Spell**, Denver, CO (US); **Bruce Davis**, Greenwood Village, CO (US); **Michael Morris**, Downingtown, PA (US)

OTHER PUBLICATIONS

Letter from StarSight Telecast, Inc. to a StarSight IPG subscriber (with subscriber name, address and account number redacted) notifying the subscriber of termination of the StarSight IPG.

(Continued)

(73) Assignee: **United Video Properties, Inc.**, Tulsa, OK (US)

*Primary Examiner*—Michael H. Lee

(74) *Attorney, Agent, or Firm*—Fish & Neave IP Group; Ropes & Gray LLP

(\*) Notice: Subject to any disclaimer, the term of this patent is extended or adjusted under 35 U.S.C. 154(b) by 173 days.

(57) **ABSTRACT**

An electronic program schedule system which includes a receiver for receiving broadcast, satellite or cablecast television programs for a plurality of television channels and a tuner for tuning a television receiver to a selected one of the plurality of channels. A data processor receives and stores in a memory television program schedule information for a plurality of television programs to appear on the plurality of television channels. A user control apparatus, such as a remote controller, is utilized by a viewer to choose user control commands and transmit signals in response to the data processor which receives the signals in response to user control commands. A television receiver is used to display the television programs and television program schedule information. A video display generator receives video control commands from the data processor and program schedule information from the memory and displays a portion of the program schedule information in overlaying relationship with a television program appearing on a television channel in at least one mode of operation of the television programming guide. The data processor controls the video display generator with video control commands, issued in response to the user control commands, to display program schedule information for any chosen one of the plurality of television programs in overlaying relationship with at least one television program then appearing on any chosen one of the plurality of channels on the television receiver.

(21) Appl. No.: **09/997,659**

(22) Filed: **Nov. 29, 2001**

(65) **Prior Publication Data**

US 2002/0078450 A1 Jun. 20, 2002

**Related U.S. Application Data**

(63) Continuation of application No. 08/119,367, filed on Sep. 9, 1993.

(51) **Int. Cl.**  
**H04N 5/445** (2006.01)

(52) **U.S. Cl.** ..... **725/40; 725/41; 348/564; 348/906**

(58) **Field of Classification Search** ..... **348/570, 348/569, 563, 564, 906, 565; 725/39, 40, 725/43, 41; H04N 5/445**

See application file for complete search history.

(56) **References Cited**

U.S. PATENT DOCUMENTS

3,440,427 A 4/1969 Krammer

(Continued)

**30 Claims, 42 Drawing Sheets**

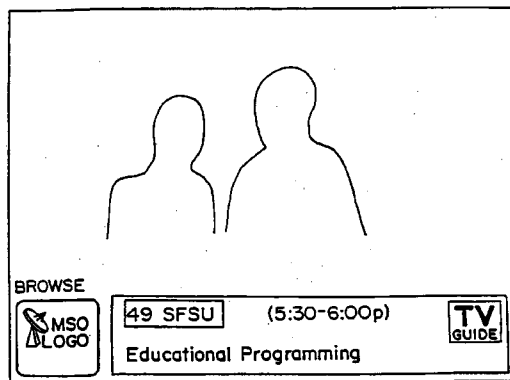

U.S. PATENT DOCUMENTS

3,492,577 A	1/1970	Reiter et al.	4,689,022 A	8/1987	Peers et al.
3,493,674 A	2/1970	Houghton	4,691,351 A	9/1987	Hayashi et al.
3,833,757 A	9/1974	Kirk, Jr. et al.	4,694,490 A	9/1987	Harvey et al.
3,891,792 A	6/1975	Kimura	4,701,794 A	10/1987	Froling et al.
3,936,868 A	2/1976	Thorpe	4,706,121 A	11/1987	Young
3,996,583 A	12/1976	Hutt et al.	4,712,105 A	12/1987	Kohler
4,004,085 A	1/1977	Makino et al.	4,751,578 A	* 6/1988	Reiter et al. .... 348/564
4,016,361 A	4/1977	Pandey	4,754,326 A	6/1988	Kram et al.
4,026,555 A	5/1977	Kirschner et al.	4,768,228 A	8/1988	Clupper et al.
4,031,548 A	6/1977	Kato et al.	4,775,935 A	10/1988	Yourick
4,052,719 A	10/1977	Hutt et al.	4,787,063 A	11/1988	Muguet
4,079,419 A	3/1978	Siegle et al.	4,821,102 A	4/1989	Ichikawa et al.
4,081,753 A	3/1978	Miller	4,862,268 A	8/1989	Campbell et al.
4,081,754 A	3/1978	Jackson	4,890,321 A	12/1989	Seth-Smith
4,096,524 A	6/1978	Scott	4,894,789 A	1/1990	Yee
4,134,127 A	1/1979	Campioni	4,908,707 A	3/1990	Kinghorn
4,139,860 A	2/1979	Micic et al.	4,908,713 A	3/1990	Levine
4,150,254 A	4/1979	Schussler et al.	4,959,720 A	9/1990	Duffield et al.
4,156,850 A	5/1979	Beyers, Jr.	4,963,994 A	10/1990	Levine
4,161,728 A	7/1979	Insam	4,977,455 A	12/1990	Young
4,162,513 A	7/1979	Beyers, Jr. et al.	4,991,012 A	* 2/1991	Yoshino .... 348/565
4,170,782 A	10/1979	Miller	5,038,211 A	8/1991	Hallenbeck
4,186,413 A	1/1980	Mortimer	5,045,947 A	9/1991	Beery
4,203,130 A	5/1980	Doumit	5,047,867 A	9/1991	Strubbe et al.
4,205,343 A	5/1980	Barrett	5,068,734 A	11/1991	Beery
4,218,698 A	8/1980	Bart et al.	5,103,314 A	4/1992	Keenan
4,228,543 A	10/1980	Jackson	5,151,789 A	9/1992	Young
4,231,031 A	10/1980	Crowther et al.	5,210,611 A	5/1993	Yee et al.
4,233,628 A	11/1980	Ciciora	5,214,622 A	5/1993	Nemoto
4,249,211 A	2/1981	Baba et al.	5,220,420 A	6/1993	Hoarty et al.
4,261,006 A	4/1981	Weintraub et al.	5,223,924 A	6/1993	Strubbe
4,264,924 A	4/1981	Freeman	5,231,493 A	7/1993	Apitz
4,270,145 A	5/1981	Farina	5,235,415 A	8/1993	Bonicel et al.
4,283,787 A	8/1981	Chambers	5,237,411 A	8/1993	Fink et al.
4,288,809 A	9/1981	Yabe	5,237,417 A	8/1993	Hayashi et al.
4,305,101 A	12/1981	Yarbrough et al.	5,253,066 A	10/1993	Vogel
4,329,684 A	5/1982	Monteath et al.	5,353,121 A	* 10/1994	Young et al. .... 725/52
4,337,480 A	6/1982	Bourassin et al.	5,357,276 A	* 10/1994	Banker et al. .... 348/906
4,337,483 A	6/1982	Guillou	5,382,983 A	1/1995	Kwoh et al.
4,344,090 A	8/1982	Belisomi	5,404,393 A	4/1995	Remillard
4,381,522 A	4/1983	Lambert	5,410,326 A	4/1995	Goldstein
4,388,645 A	6/1983	Cox et al.	5,477,262 A	12/1995	Banker et al. .... 348/7
4,390,901 A	6/1983	Keiser	5,479,268 A	12/1995	Young et al.
4,393,376 A	7/1983	Thomas	5,485,221 A	1/1996	Banker et al.
4,405,946 A	9/1983	Knight	5,528,304 A	6/1996	Cherrick et al.
4,412,244 A	10/1983	Shanley, II	5,532,754 A	7/1996	Young et al.
4,413,281 A	11/1983	Thonnart	5,583,560 A	12/1996	Florin et al.
4,420,769 A	12/1983	Novak	5,594,509 A	1/1997	Florin et al.
4,425,581 A	1/1984	Schweppe	5,621,456 A	4/1997	Florin et al.
4,429,385 A	1/1984	Cichelli et al.	5,734,853 A	* 3/1998	Hendricks et al. .... 345/716
4,449,249 A	5/1984	Price	5,798,785 A	8/1998	Hendricks et al.
4,456,925 A	6/1984	Skerlos	5,808,608 A	9/1998	Young et al.
4,477,830 A	10/1984	Lindman et al.	5,990,927 A	11/1999	Hendricks et al.
4,488,179 A	12/1984	Kruger et al.			
4,495,654 A	1/1985	Deiss			
4,496,171 A	1/1985	Cherry			
4,496,804 A	1/1985	Hung			
4,496,976 A	1/1985	Swanson et al.			
4,510,623 A	4/1985	Bonneau et al.			
4,536,791 A	8/1985	Campbell et al.			
4,547,804 A	10/1985	Greenberg			
4,566,034 A	1/1986	Harger et al.			
4,587,520 A	5/1986	Astle			
4,595,951 A	6/1986	Filliman			
4,595,952 A	6/1986	Filliman			
4,598,288 A	7/1986	Yarbrough et al.			
4,620,229 A	10/1986	Amano et al.			
4,635,121 A	1/1987	Hoffman			
4,641,205 A	2/1987	Beyers, Jr.			
4,677,466 A	6/1987	Lert, Jr. et al.			

FOREIGN PATENT DOCUMENTS

DE	32 46 225	6/1984
DE	3337204	4/1985
DE	3621263	7/1988
EP	0 337 336	10/1989
EP	0 393 555	10/1990
EP	0 401 930	12/1990
EP	0 408 892	1/1991
EP	0 444 496 A1	9/1991
EP	0 532 322	3/1993
FR	2 662 895	12/1991
GB	2 034 995	6/1980
GB	2 126 002	3/1984
GB	2185670	7/1987
GB	2 256 546	12/1992
JP	58-137334	8/1983
JP	58-137344	8/1983

JP	58-196738	11/1983
JP	59-141878	8/1984
JP	61-50470	3/1986
JP	61-74476	4/1986
JP	62-60384	3/1987
WO	GB 87/00884	6/1986
WO	WO 90/15507	12/1990
WO	US91/06367	3/1992
WO	WO 93/05452	5/1993
WO	WO 93/11639	6/1993

## OTHER PUBLICATIONS

Contents of the website of StarSight Telecast, Inc. (<http://www.StarSight.com>) as of Apr. 21, 2004.

Transcript of the testimony of Michael Faber and Larry Wangberg, May 1996, pp. 554–743.

Transcript of the testimony of Brian Kiosterman, May 1997, pp. 1700–1981.

IPG Attitude And Usage Study, prepared by Lieberman Research Worldwide for Gemstar–TV Guide International, Oct. 2002.

Florin et al., Prosecution History of U.S. Appl. No. 08/082, 081, filed Jun. 22, 1993, including EZTV DEMO videotape. M/A–COM, Inc., “Videocipher II Satellite Descrambler Owner’s Manual,” dated prior to Feb. 1986.

Tech Notes: Product Updates from M/A–COM Cable Home Group, “Videocipher Owner’s Manual Update,” Issue No. 6, Feb. 1986.

Videocipher Stipulation, May 1996.

Transcript of the Deposition of John Roop, Oct. 1996, pp. 186–187.

Transcript of the Deposition of John Roop, Jun. 2001, p. 608.

Florin et al., Prosecution History of U.S. Appl. No. 08/082, 056 (now U.S. Pat. No. 5,621,456), filed Jun. 22, 1993, and the references contained therein.

Hedger, J., “Telesoftware: Home Computing Via Broadcast Teletext,” IEEE Transactions on Consumer Electronics, vol. CE–25, No. 3, Jul. 1979, pp. 279–287.

Baer, R.H., “Innovation Add-On TV Products,” IEEE Transactions on Consumer Electronics, vol. CE–25, Nov. 1979, pp. 765–771.

Karstad, K., “Microprocessor Control for Color–TV Receivers,” IEEE Transactions on Consumer Electronics, vol. CE–26, May 1980, pp. 149–155.

Videotext Programmiert Videorecorder, Rundfunktech Mitteilungen, Broadcast Engineering Reports, vol. 26, Nov.–Dec. 1982.

Veith, R.J., Television’s Teletext, Elsevier Science publishing Co., Inc., 1983, pp. 13–20, 41–51.

Japan Mechanical Engineering Organization Int’l Society for the Advancement of Image Software, “Technological Examination & Basic Investigative Research Report on Image Databases,” Japan, Mar. 1988.

“Browsing Within Time–Driven Multimedia Documents,” Stavros Christodoulakis, Stephen Graham, publication of the Institute for Computer Research, University of Waterloo, Waterloo, Ontario, Canada, Jul. 1988, pp. 219–227.

Jerrold Communications Publication, “Cable Television Equipment,” dated 1992 and 1993, pp. 8–2.1 to 8–6 and 8–14.1 to 8–14.3.

Proceedings From The 42nd Annual Convention and Exposition of the NCTA, “Addressable Decoder with Downloadable Operation,” Jun. 6–9, 1993, pp. 82–89.

James A., “Oracle—Broadcasting the Written Word,” Wireless World, Jul. 1973, pp. 314–316.

McKenize, G.A. “Oracle—An Information Broadcasting Service Using Transmission in the Vertical Interval,” Journal of the SMPTE, Jan. 1974, pp. 6–10.

Edwardson, S.M., & Gee, A., “CEEFAX: A Proposed New Broadcasting Ser.,” Journal of the SMPTE, Jan. 1974, pp. 14–19.

Hedger J., “Telesoftware: Home Computing Via Broadcast Teletext,” IEEE Transactions on Consumer Electronics, vol. CE–25, No. 3, Jul. 1979, pp. 279–287.

Came, E.B., “The Wire Household,” IEEE Spectrum, Oct. 1979, pp. 61–66.

Baer, R.H., “Innovation Add-On TV Products,” IEEE Transactions on Consumer Electronics, vol. CE–25, Nov. 1979.

“The New Media and Broadcast Policy: An Investigation & Research Conference Report on Broadcasting Diversification,” Japan Ministry of Posts & Telecommunications, Mar. 1982.

“Videotext Programmiert Videorecorder,” Rundfunktech Mitteilungen, Nov.–Dec., 1983, Broadcast Engineering Reports, vol. 26, Nov.–Dec., 1982.

Veith, R.H., “Television’s Teletext,” Elsevier Science Publishing Co., Inc., 1983, pp. 13–20, 45–51.

“Learning Considerations in User Interface Design: The Room Model”; author: Patrick P. Chan; publication of the Software Portability Laboratory, University of Waterloo, Waterloo, Ontario, Canada Jul. 1984.

Damouny, N.G., “Teletext Decoders—Keeping Up With the latest Advances,” IEEE Transactions on Consumer Electronics, vol. CE–30, No. 3, Aug. 1984, pp. 429–435.

“High–Tech TV,” Seafon, Peggy, Photographic, Dec. 1984.

D.J. Rayers, “Telesoftware by Teletext,” 1984 IEEE Conf. Papers, vol. 240, p. 323.

Lowenstein, R.L., and Alter, H.E., “Technology Review,” vol. 88, Oct. 1985, p. 22.

Japan Soc. of Data Comm., “Development Study and Research Report on New Media Interface Technology: Status & Issue Related to Combining Databases & New Media,” Mar. 1986.

CableVision Advertisement for “TV Decisions,” Aug. 1986.

Judice, C.N., “Move Over Cable, here Come Video Via Voice Lines,” Network World, Sep. 1986, p. 26.

Charles N. Judice, “Move Over Cable, Here Comes Video Via Voice Lines,” Network World, Sep. 1, 1986, p. 26.

Bureau of Science & Technology (Japan), “Computer Network: Current Status and Outlook on Leading Science and Technology,” vol. 1, Dec. 1986.

Merrell, “Tac Timer,” 1986 NCTA Technical Papers, pp. 203–206.

K. Sunada et al., “Teletext Color Television Receiver Model C–29M950, C26M940,” NEC Home Electronics, NEC Giho, 1987.

Author unknown, “Facsimile Transmission,” NHK Research Monthly Report, Dec. 1987.

Japan, Int’l Society for the Advancement of Image Software, “Technological Examination & Basic Investigative Research Report on Image Data Bases,” Japan, Mar. 1988.

Bensch, U., “VPV Videotext Programs Videorecorder,” IEEE Paper, Jun. 1988, pp. 788–792.

“Browsing Within Time-Driven Multimedia Documents” authors Stavros Christodoulakis, Stephen Graham; publication of the Institute for Computer Research, University of Waterloo, Waterloo, Ontario, Canada, Jul. 1988.

Schiender, B.R., “Couch Potatoes! Now It’s Smart TV,” *Fortune*, Nov. 20, 1989, pp. 111–116.

D2B-Home-Bus für Audio und Video, *Selektor* Apr. 1990.  
Antonofs, M., “Stay Tuned for Smart TV,” *Science*, Nov. 1990, pp. 62–65.

42nd Annual Convention and Exposition of the NCTA, Jun. 6, 1993, San Francisco, CA, pp. 223–236, Bestler, “Flexible Data Structure and Interface Rituals for Rapid Development of OSD Applications”.

Mannes, George, “Smart Screens; Development of Personal Navigation Systems for TV Viewers,” *Video Magazine*, Dec. 1993.

Jerrold Communications Publication, “Cable Television Equipment,” dated 1992 and 1993, pp. 8–2.1 to 8–5 and 8–14.1 to 8–14.3.

Various publications of Insight Telecast, 1992 and 1993.

Preview Guide Brochure, Spring 1994.

42nd Annual Convention & Exposition of the National Cable Television Association, “Addressable Decoder with Downloadable Operation,” Jun. 6–9, pp. 82–89.

Brugliera, Vito, “Digital On-Screen Display—A New Technology for the Consumer Interface,” *Symposium Record Cable Sessions of the 18th International Television Symposium & Technical Exhibition*, pp. 571–586.

\* cited by examiner

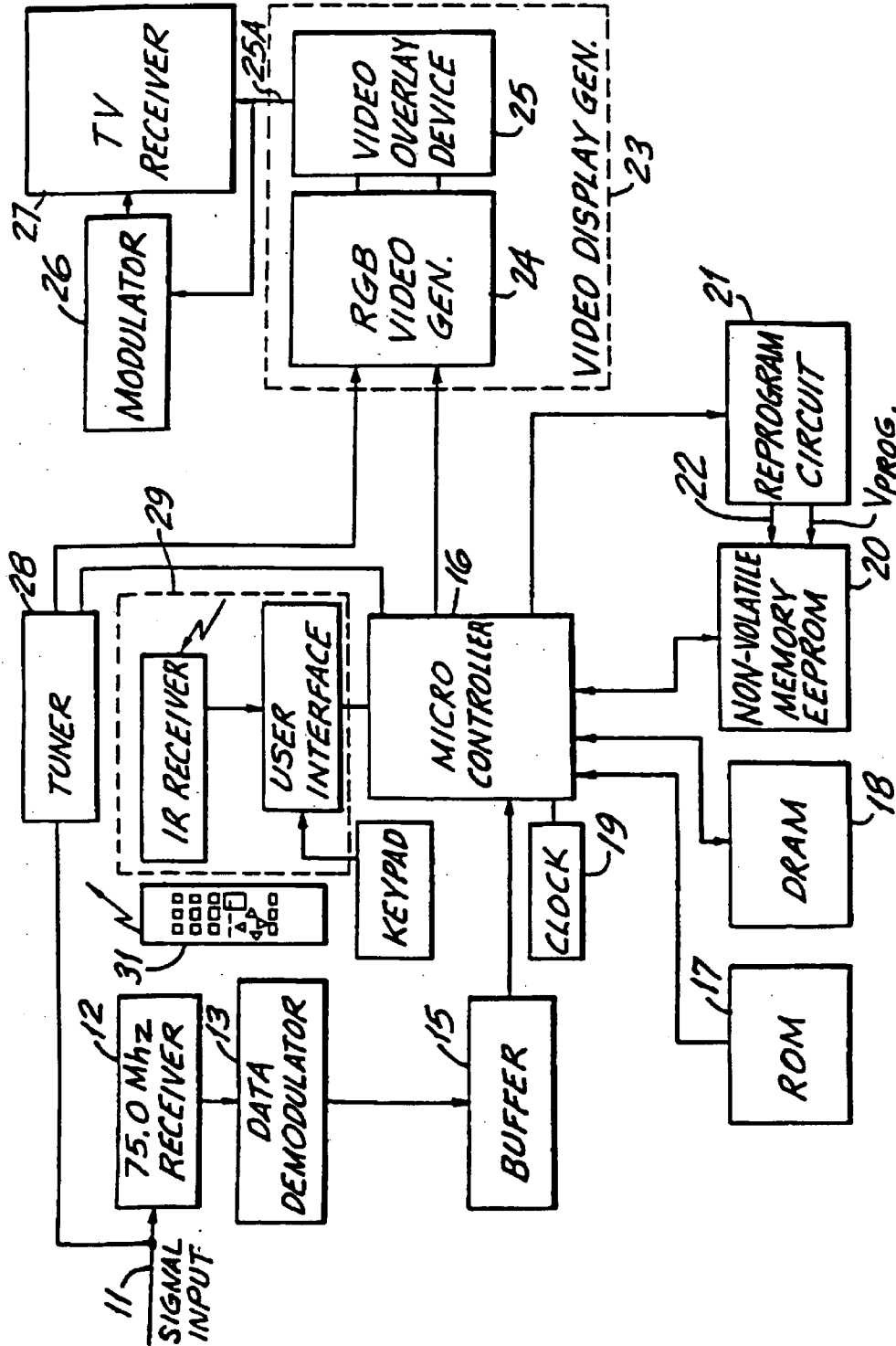

FIG. 1

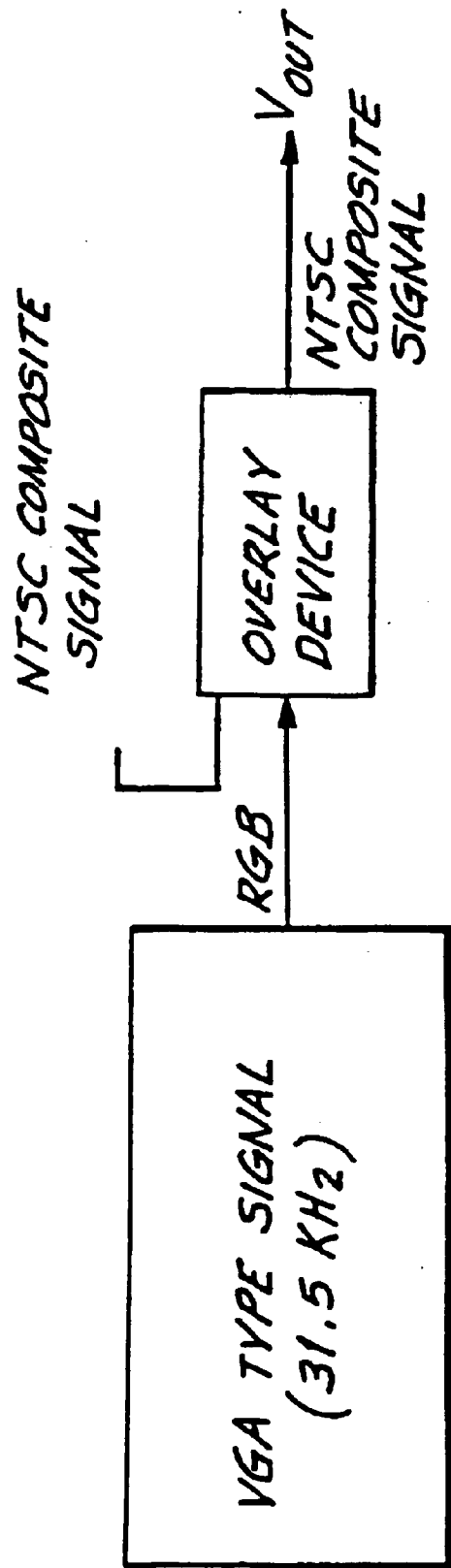

FIG. 2

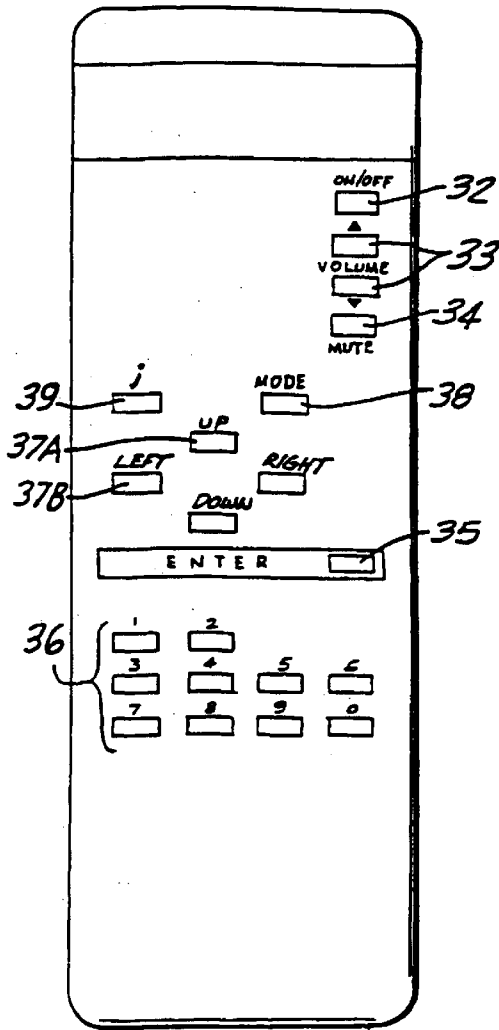

FIG. 3

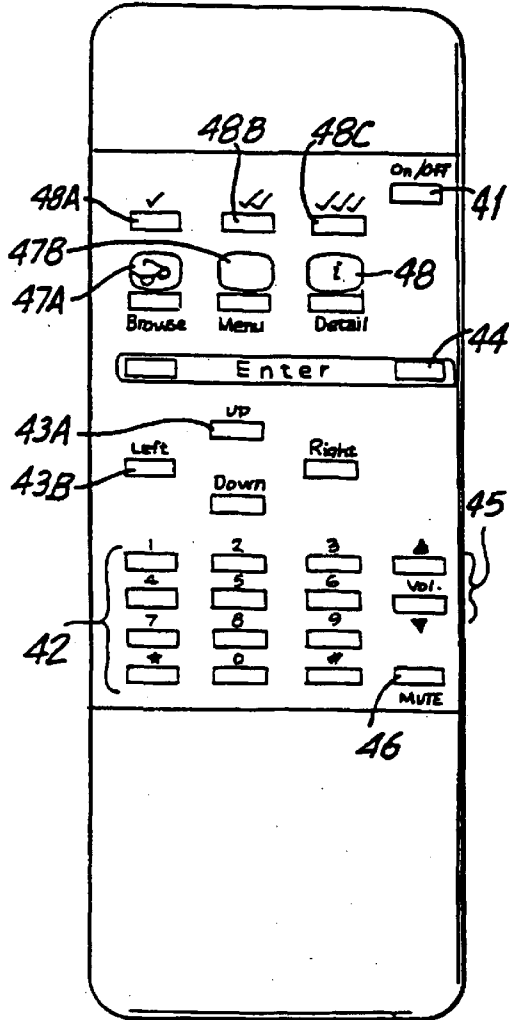

FIG. 4



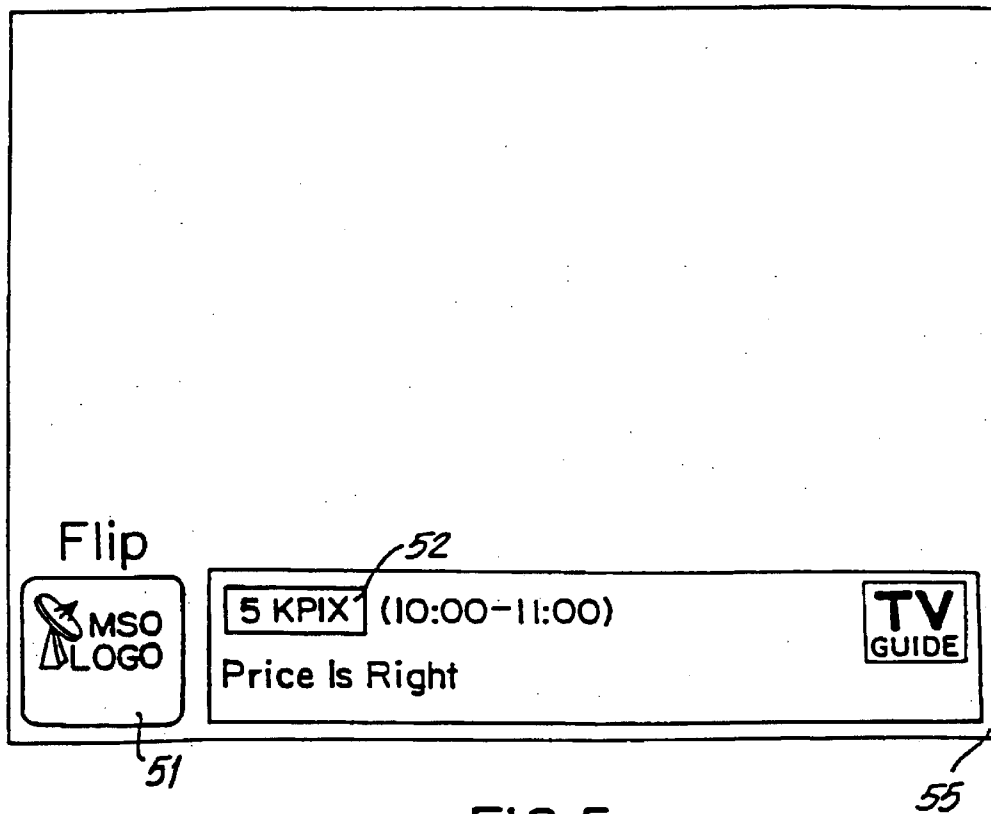
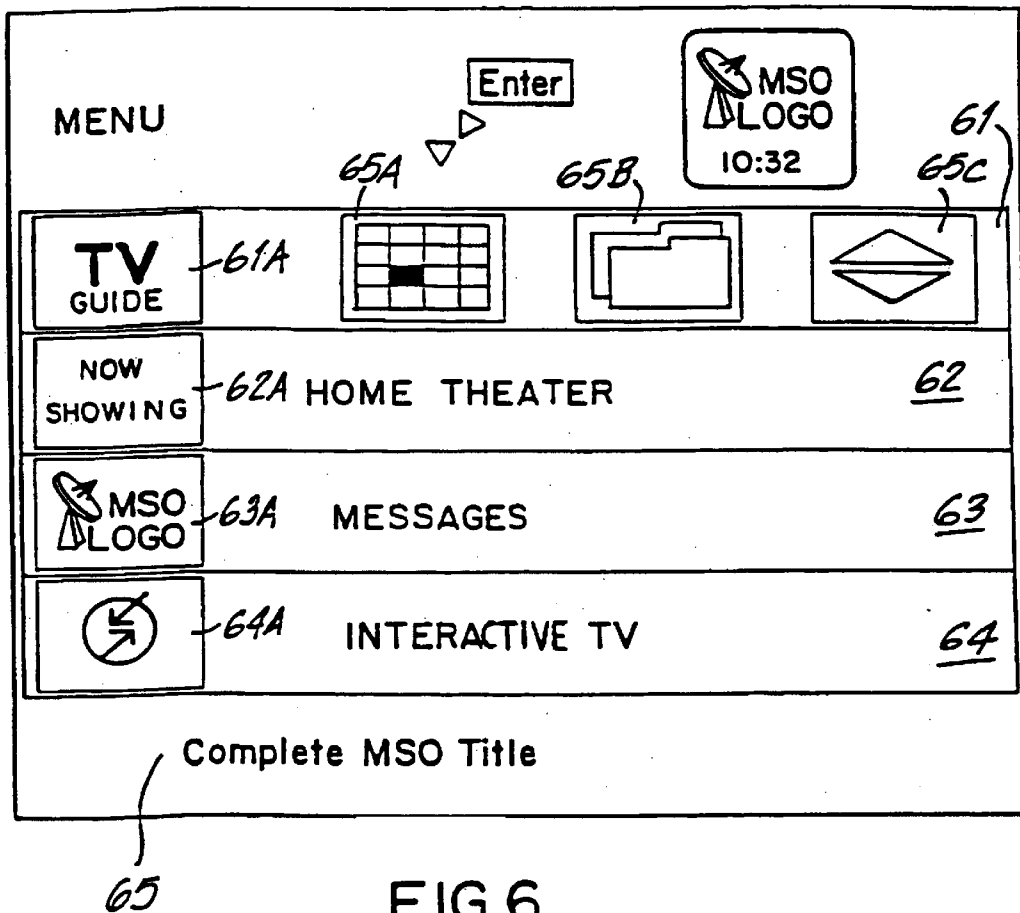

FIG. 5



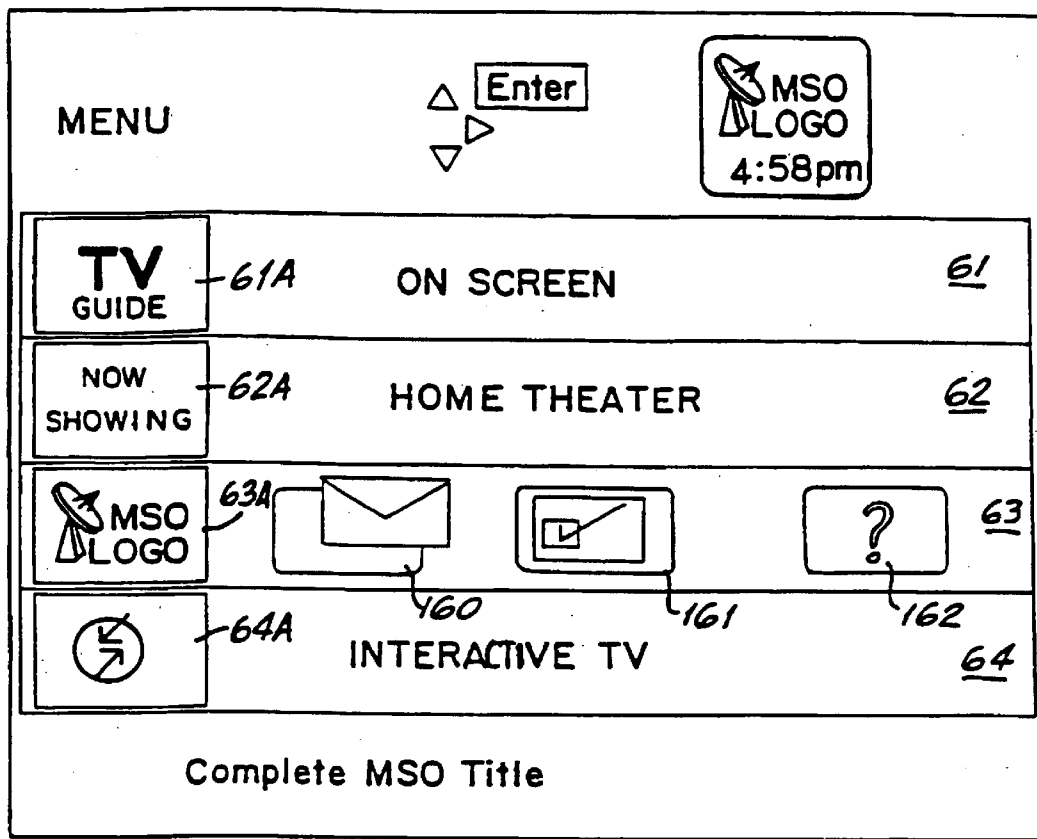

FIG.6A

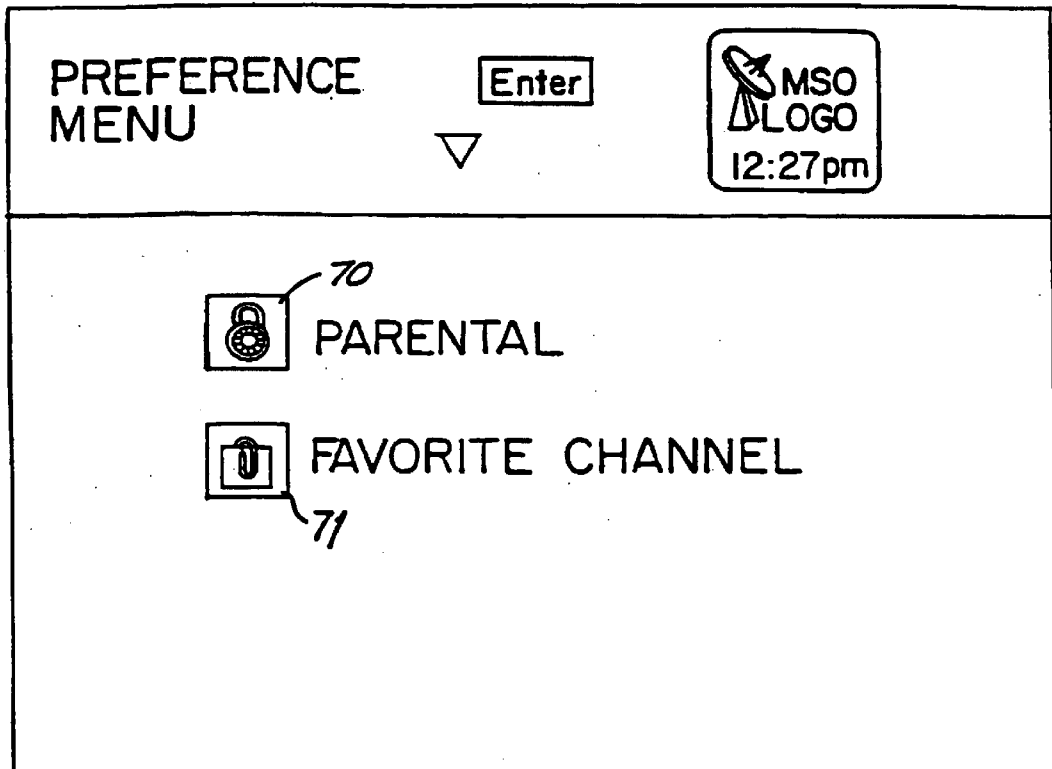

FIG.7

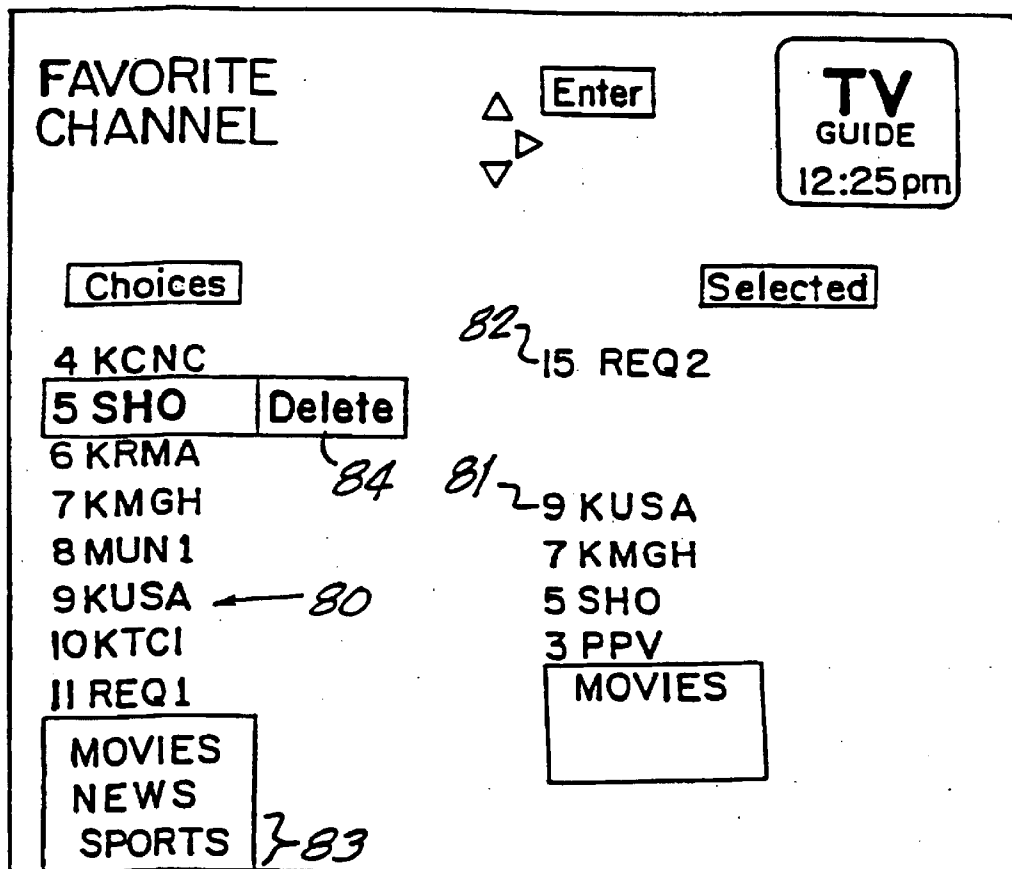

FIG. 8

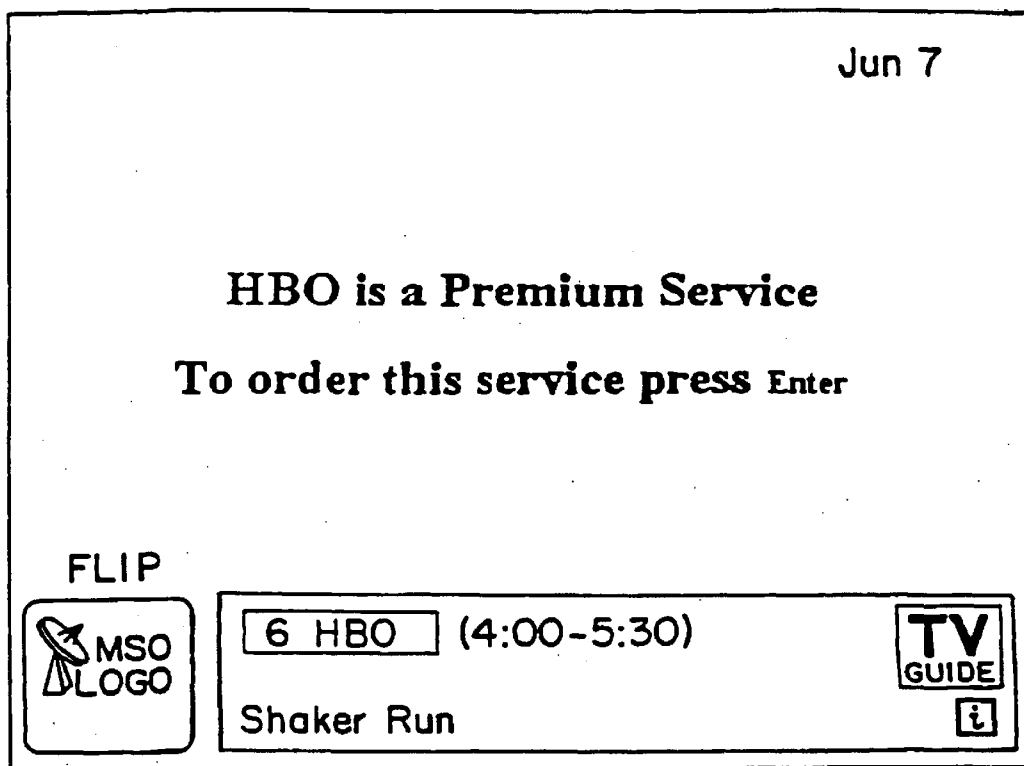

FIG.9

Premium Services	<input type="button" value="Enter"/>	
<input type="button" value="HBO"/>	Home Box Office	\$10.40/Month
<input type="button" value="SHO"/>	Showtime	\$9.95/Month
<input type="button" value="DIS"/>	The Disney Channel	\$9.95/Month
<input type="button" value="TMC"/>	The Movie Channel	\$1.50/Month
<input type="button" value="MAX"/>	Cinemax	\$9.95/Month
<input type="button" value="PLA"/>	Playboy at Night	\$4.95/Evening(5:00pm to 3:00am)
<input type="button" value="ACT"/>	Action	\$5.95/Day(11:00pm to 3:00pm)
Movie, special events and family programming!		
You are not a Subscriber. Press <input type="button" value="Enter"/> to Subscribe!		

FIG. 10

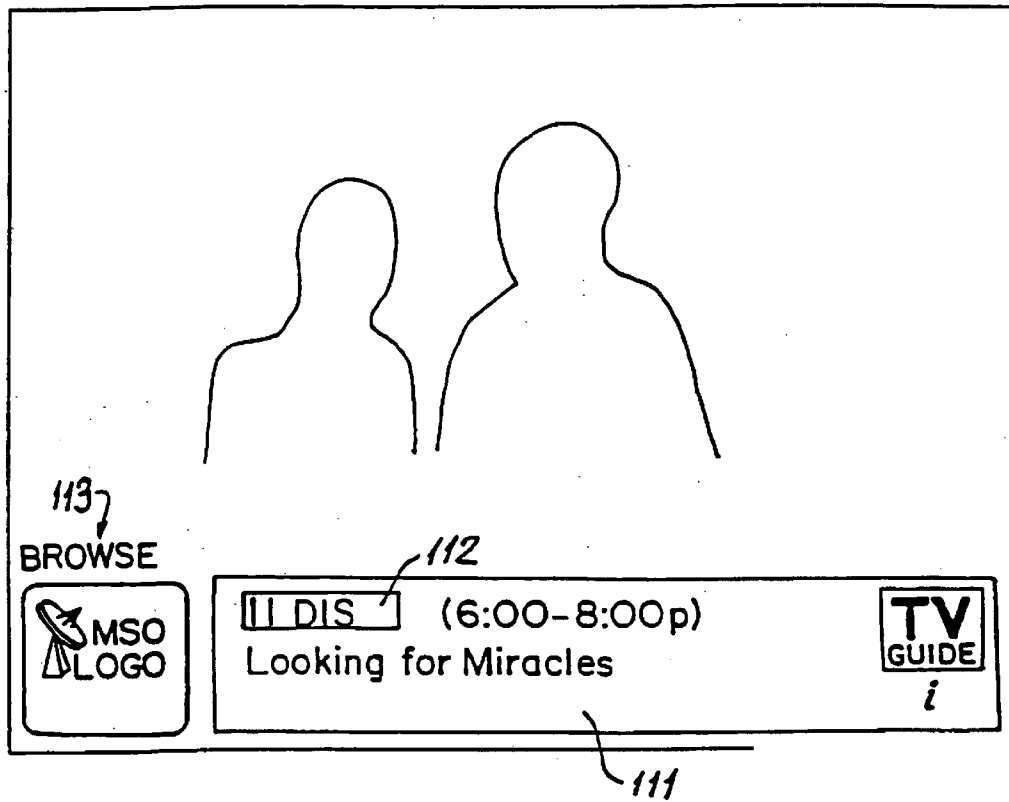

FIG. II



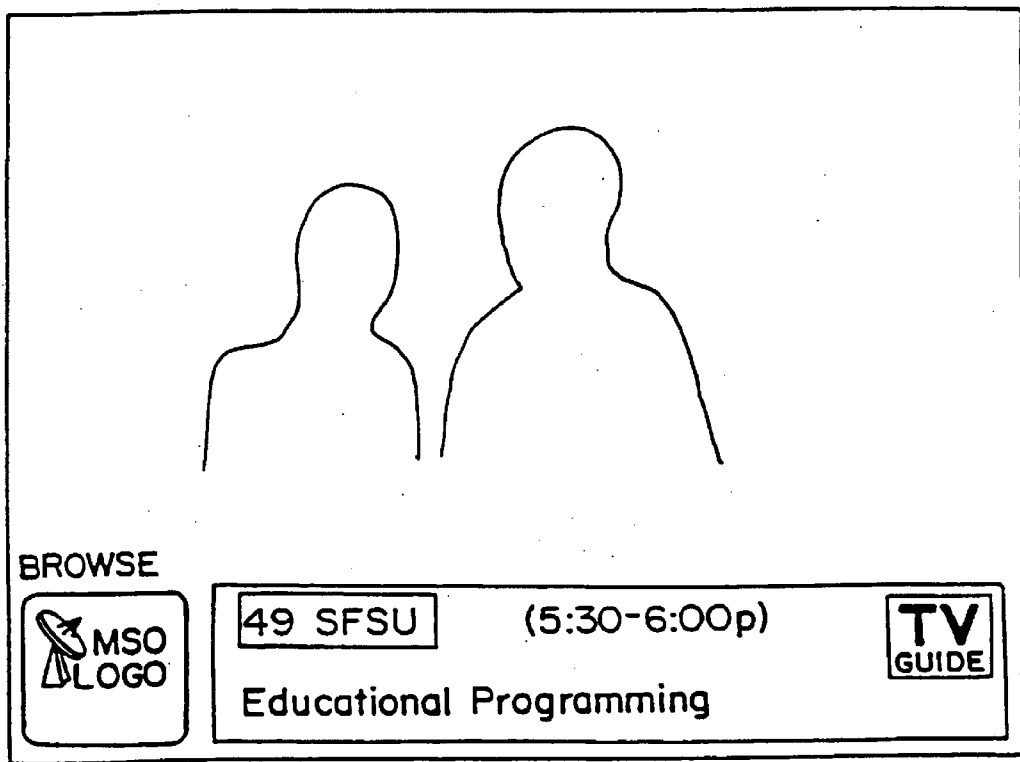

FIG. 12

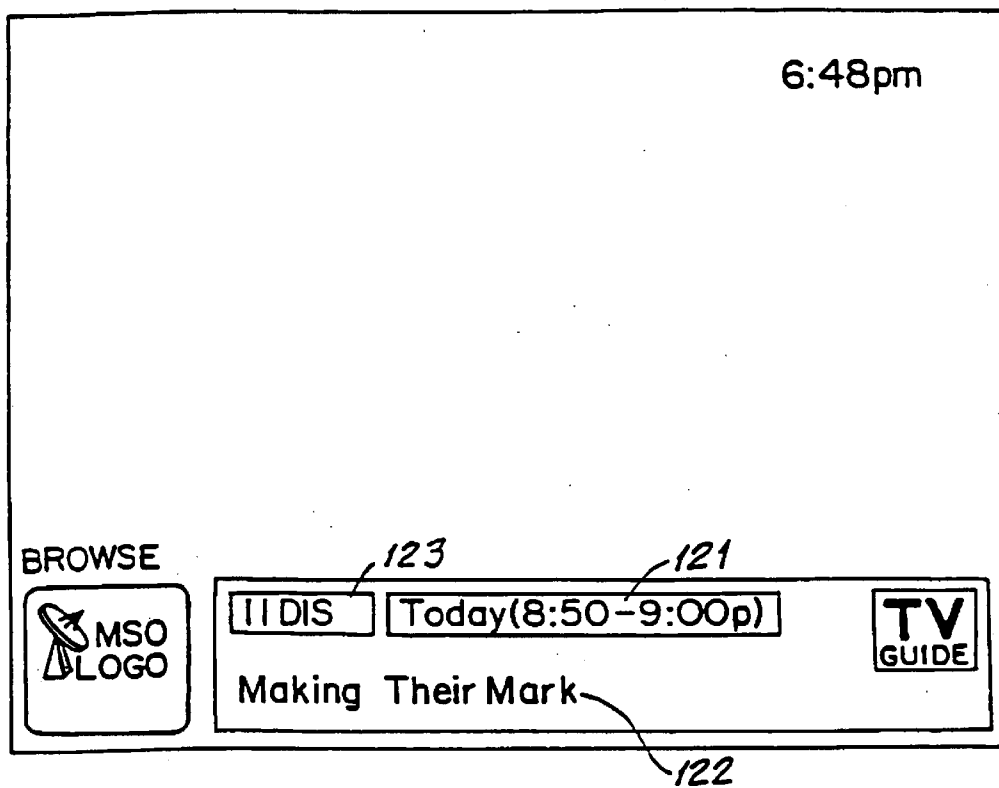

FIG. 12A

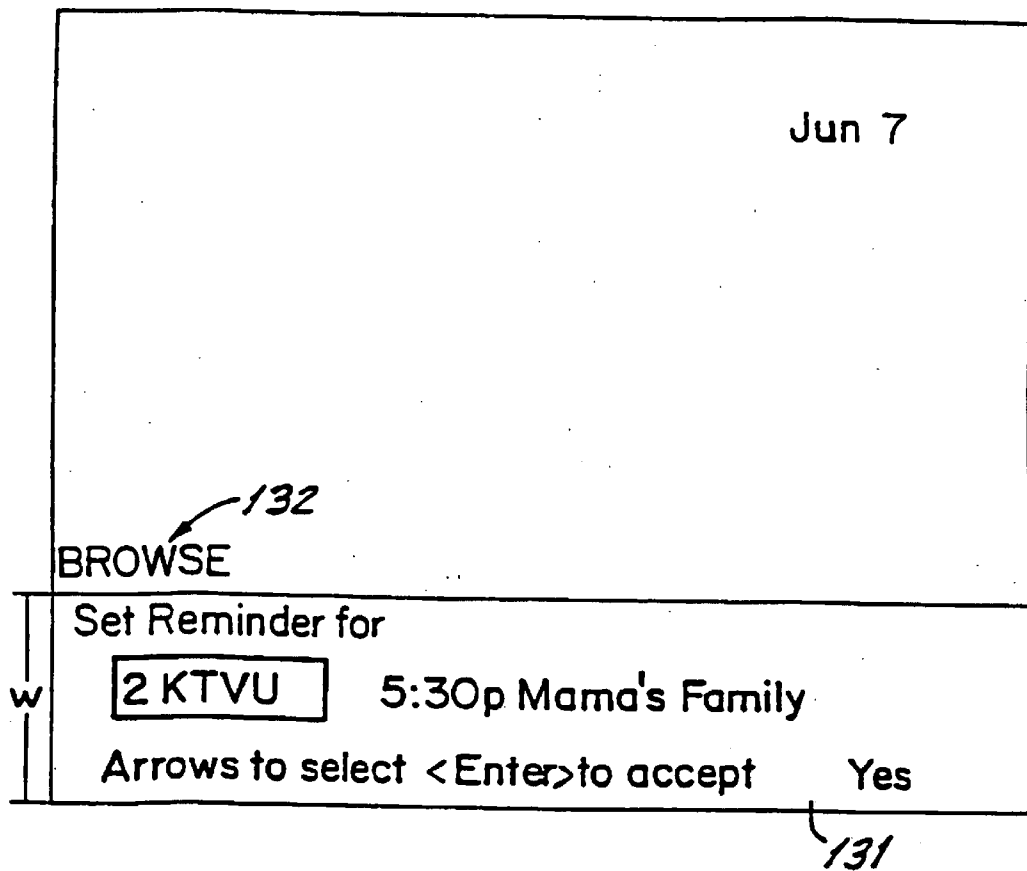

FIG.13

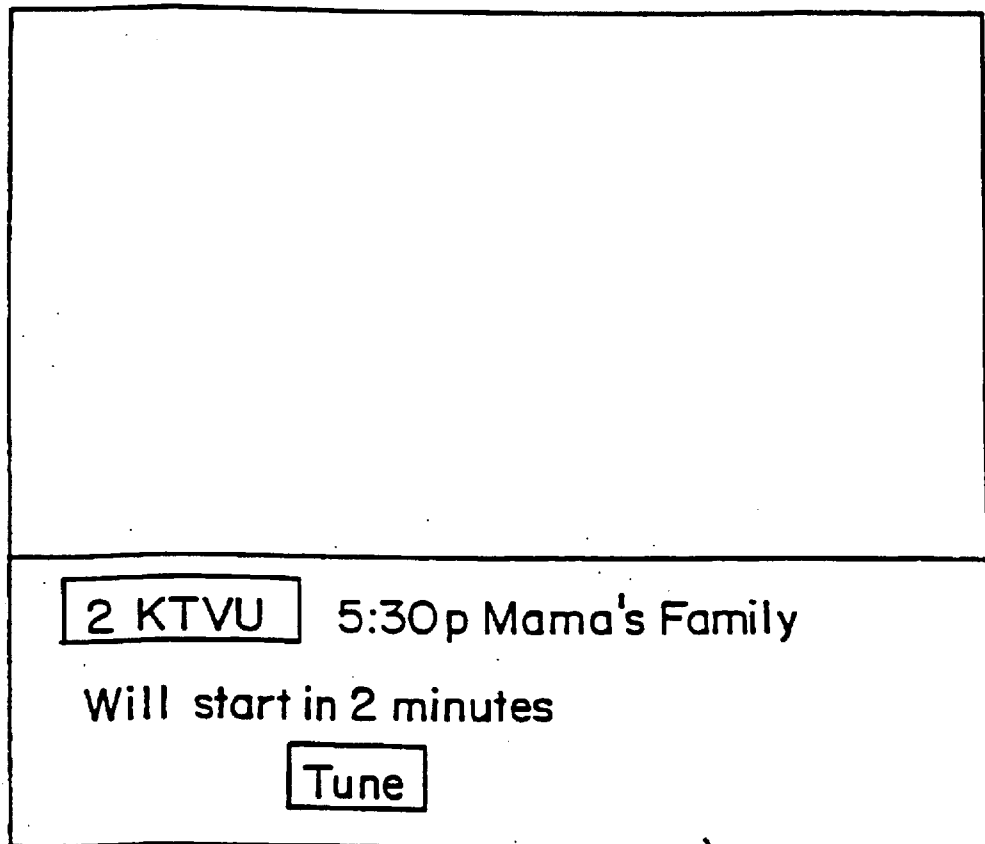

FIG.14

140

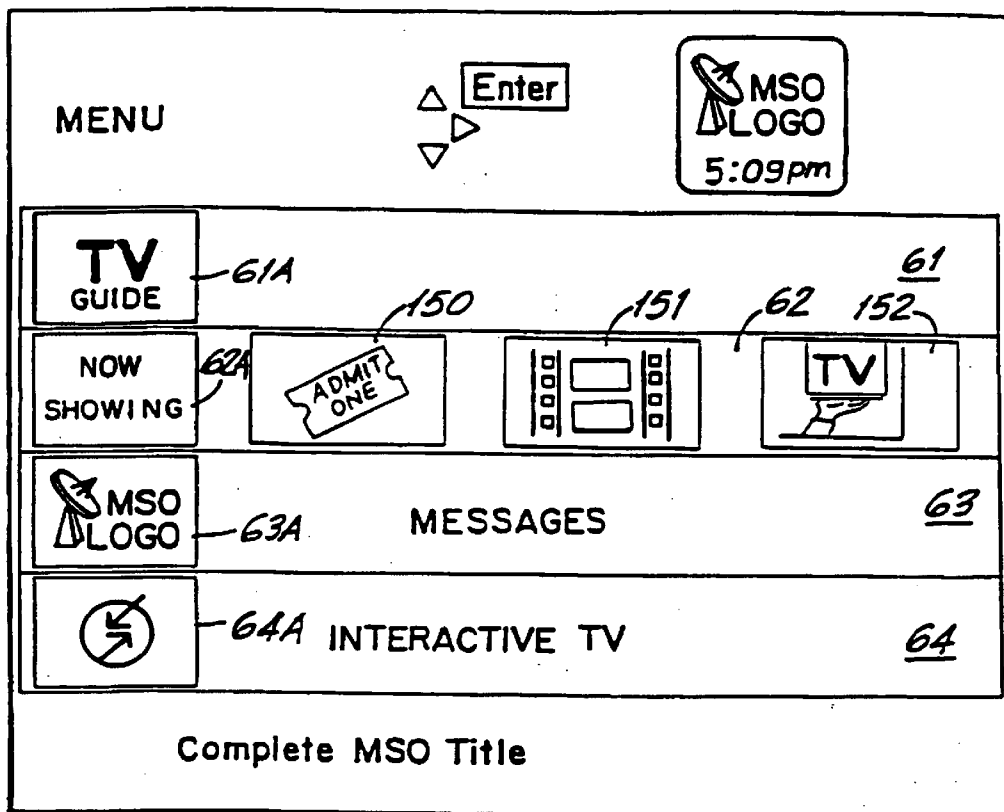

FIG.15

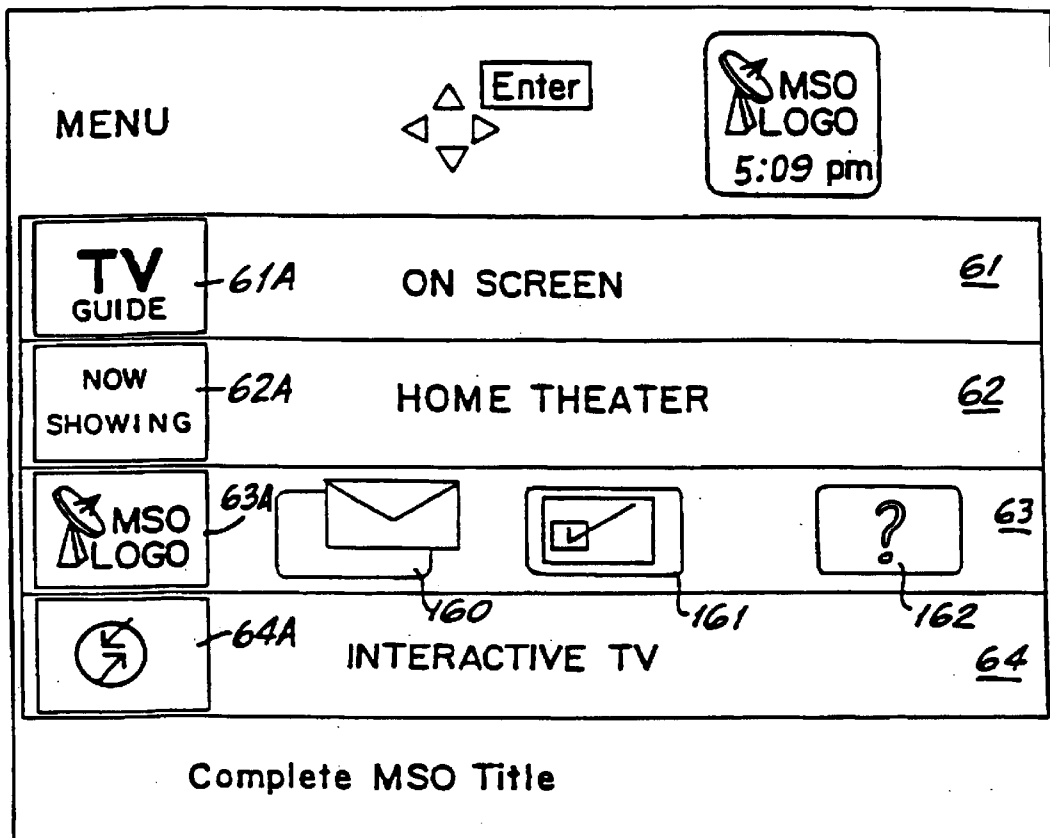

FIG. 6

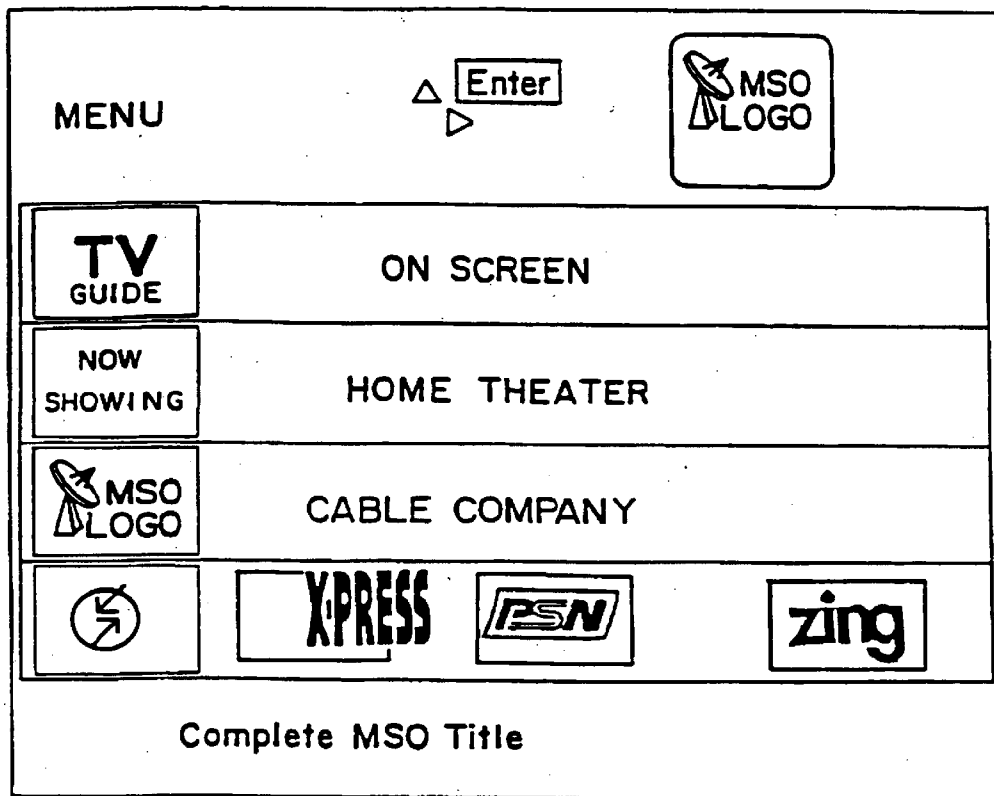

FIG.17

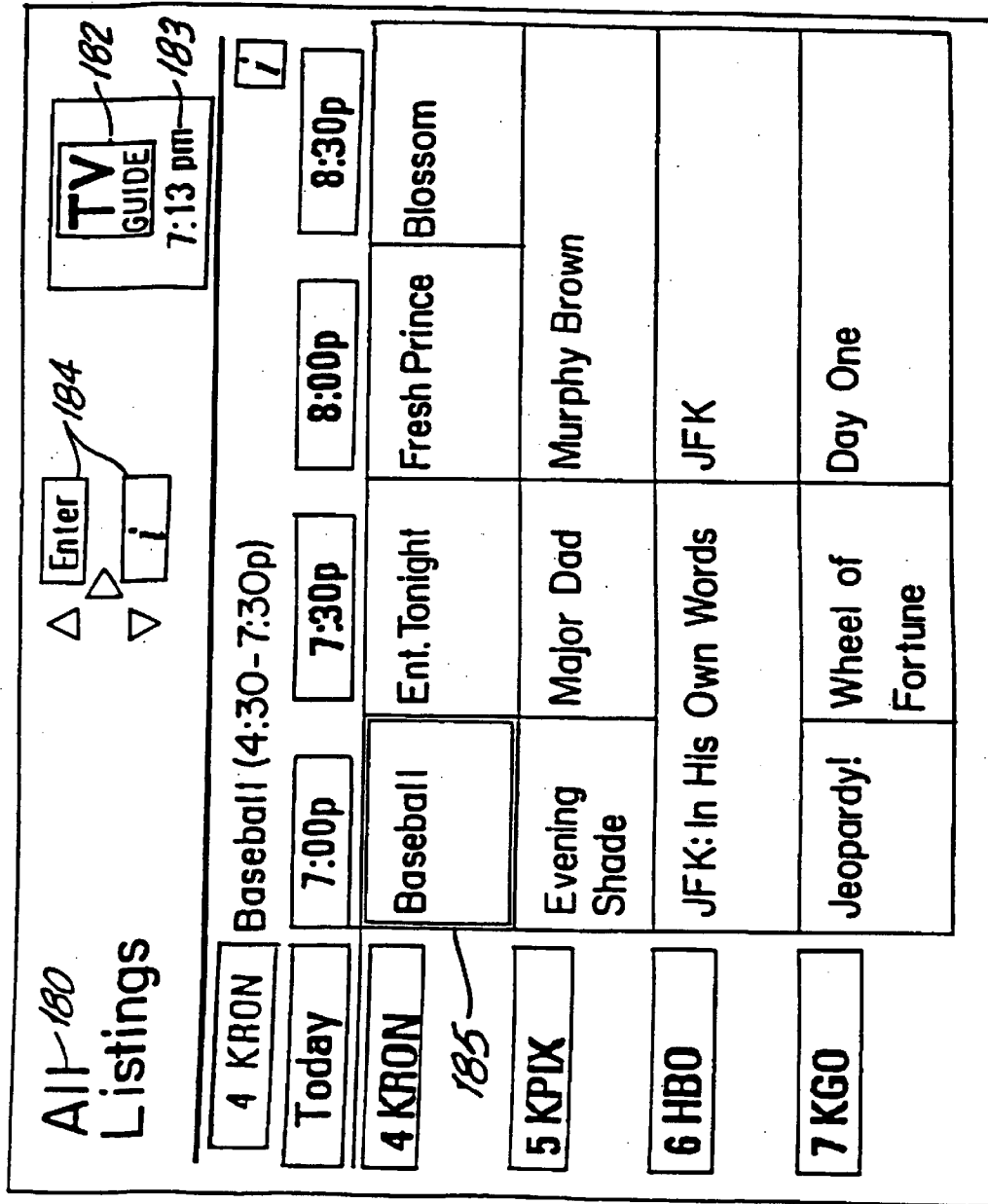

FIG. 18



**Enter**  **1900**  
 **TV GUIDE**  **5:45 pm**  
**Listings By**  
**Category**  **190A**  **190B**  **190C**  
 **Movies**  **Sports**  **News**  **Children**  
 **Today**

<input type="text"/> 22 LIF	4:00p A Case of Deadly Force	<input type="text"/> i
<input type="text"/> 1 HOT	4:00p Ring of Fire II: Blood and Steel	<input type="text"/> i
<input type="text"/> 34 AMC	4:00p Texas Across the River	<input type="text"/> i
<input type="text"/> 31 MAX	4:00p The Ballad of the Sad Cafe	<input type="text"/> i
<input type="text"/> 8 SHO	5:00p Big Girls Don't Cry - They Get Even	<input type="text"/> i
<input type="text"/> 46 BRV	5:00p Queen of Hearts	<input type="text"/> i
<input type="text"/> 27 TMC	5:00p The Roaring Twenties	<input type="text"/> i
<input type="text"/> 25 TBS	5 05p No Mercy	<input type="text"/> i

FIG. 19

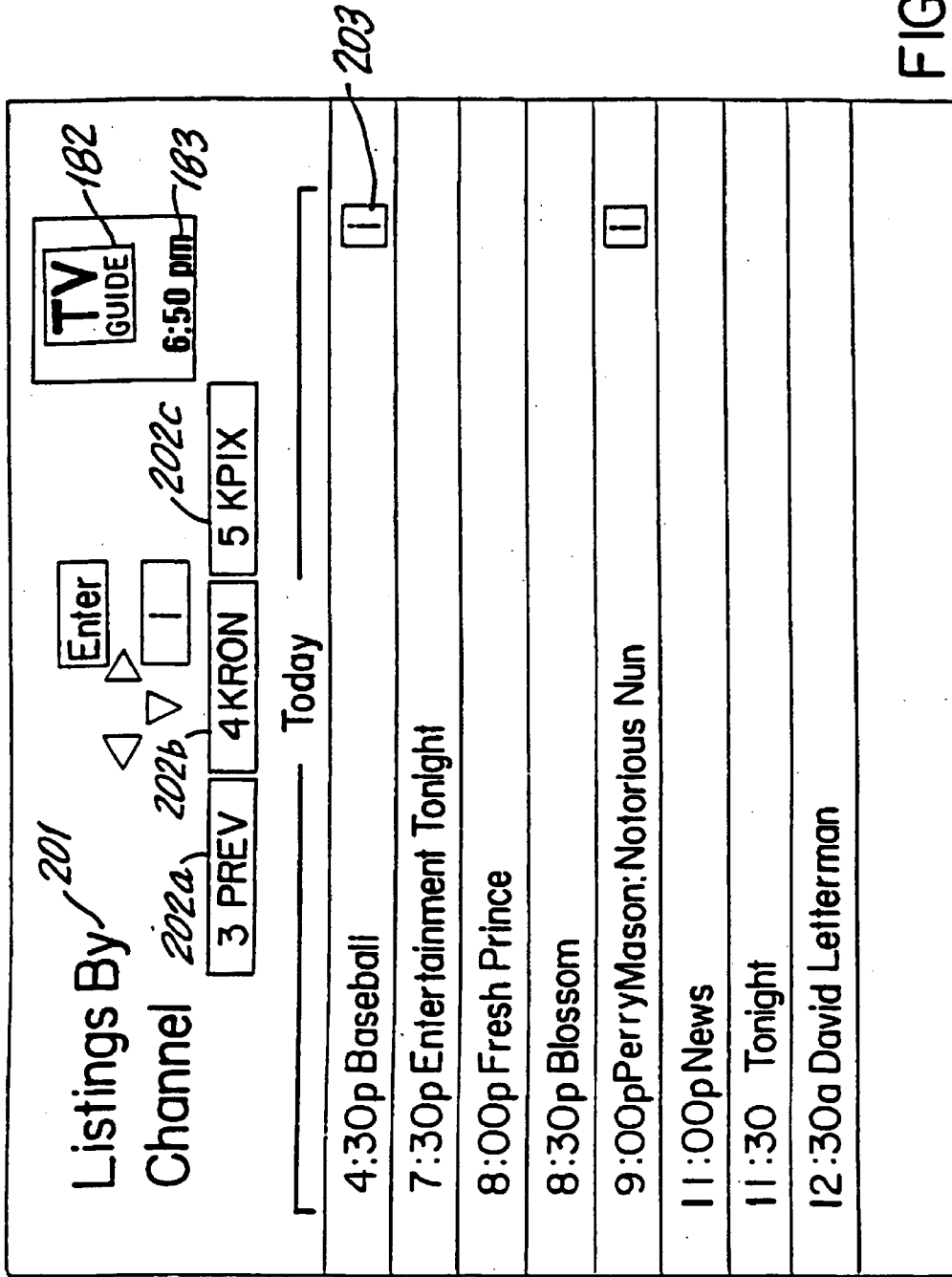

FIG. 20

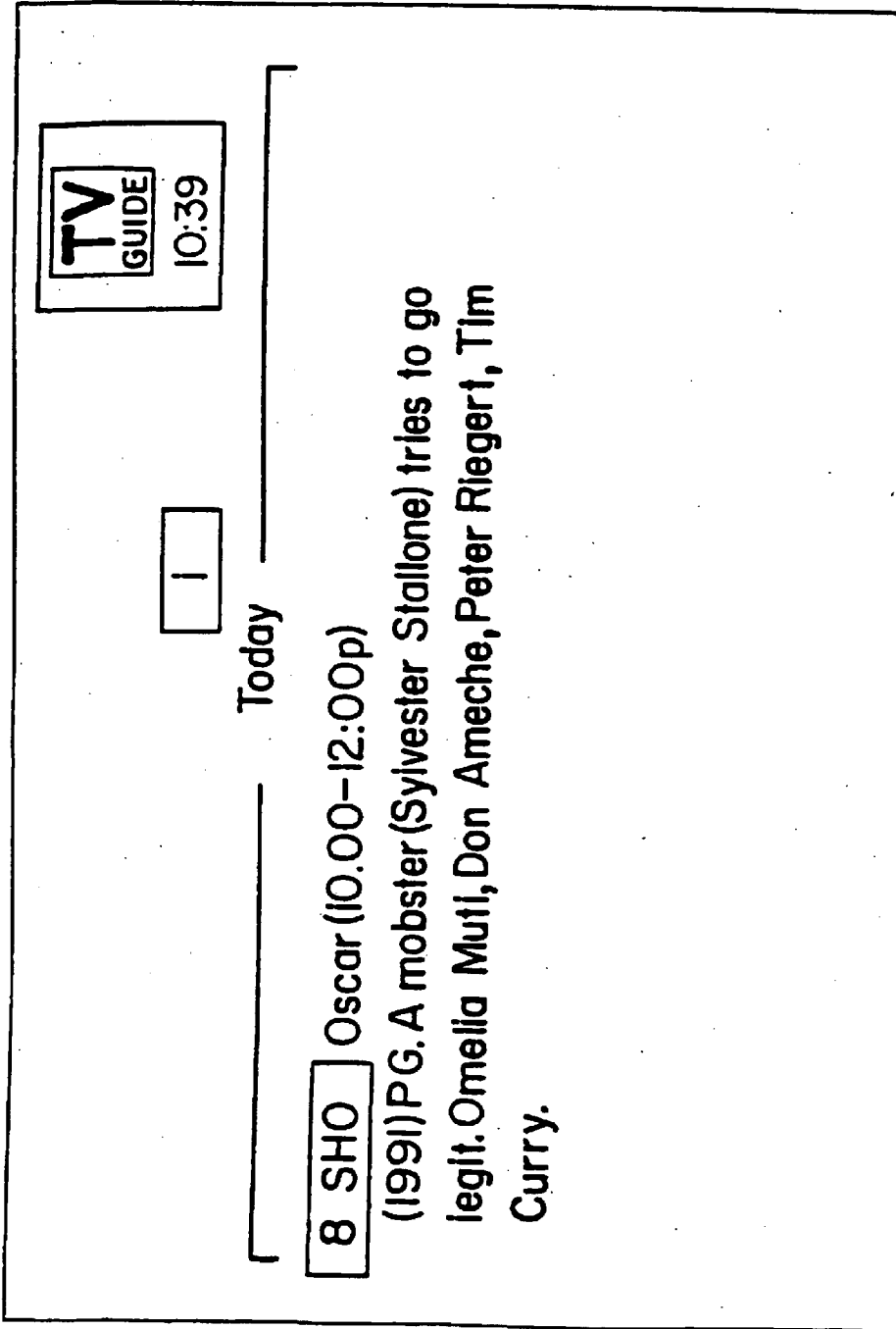
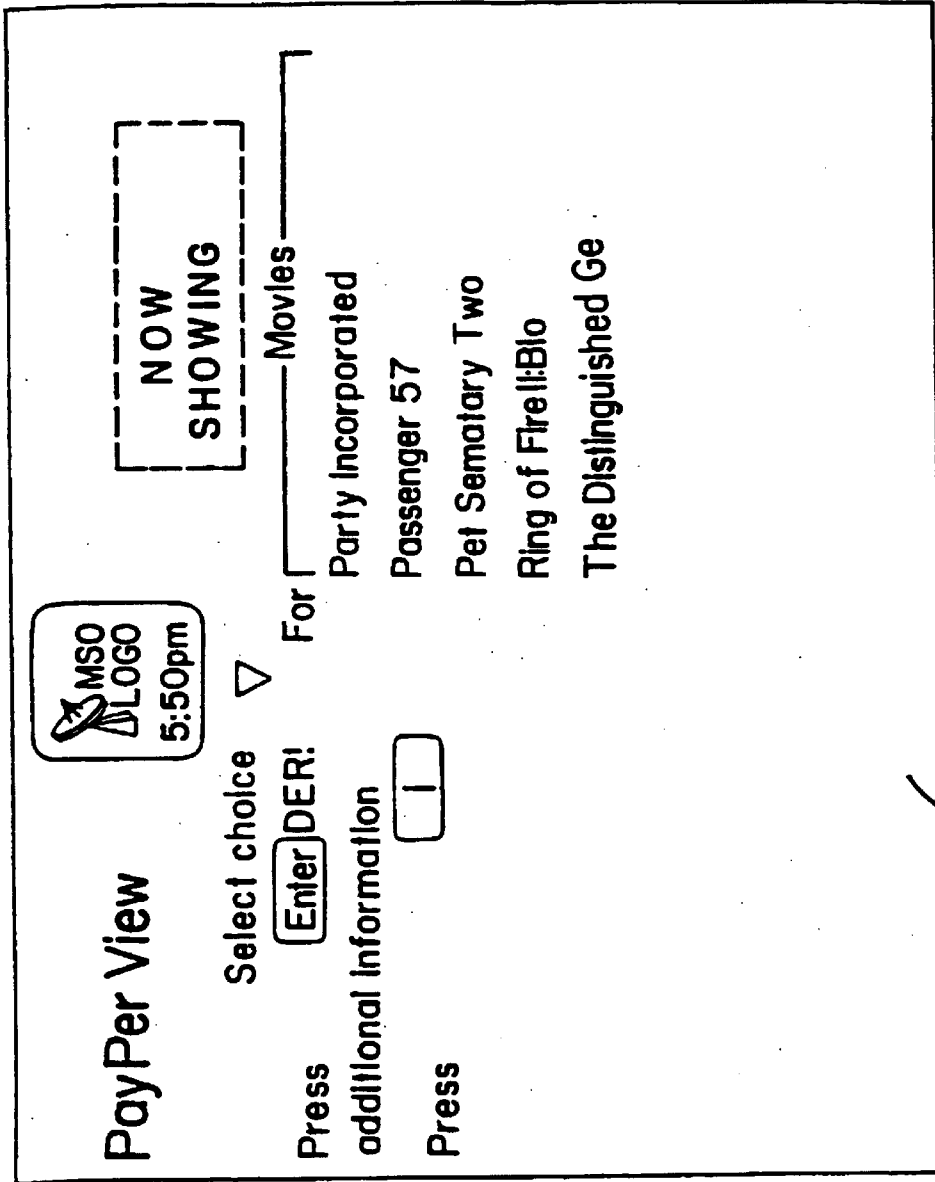

FIG. 21



220 ✓  
FIG. 22

Pay Per View  
Ordering

Enter

MSO  
LOGO  
5:49 PM

\$ 3.99

Passenger 57

What time would you like this show to start?

Today 9:00p <sup>230B</sup> Tomw 12:00p Tomw 6:00p <sup>230C</sup>

230A

Would you like to see a countdown onscreen  
just before the show start

Yes No

PPV /
/ Source

FIG.23

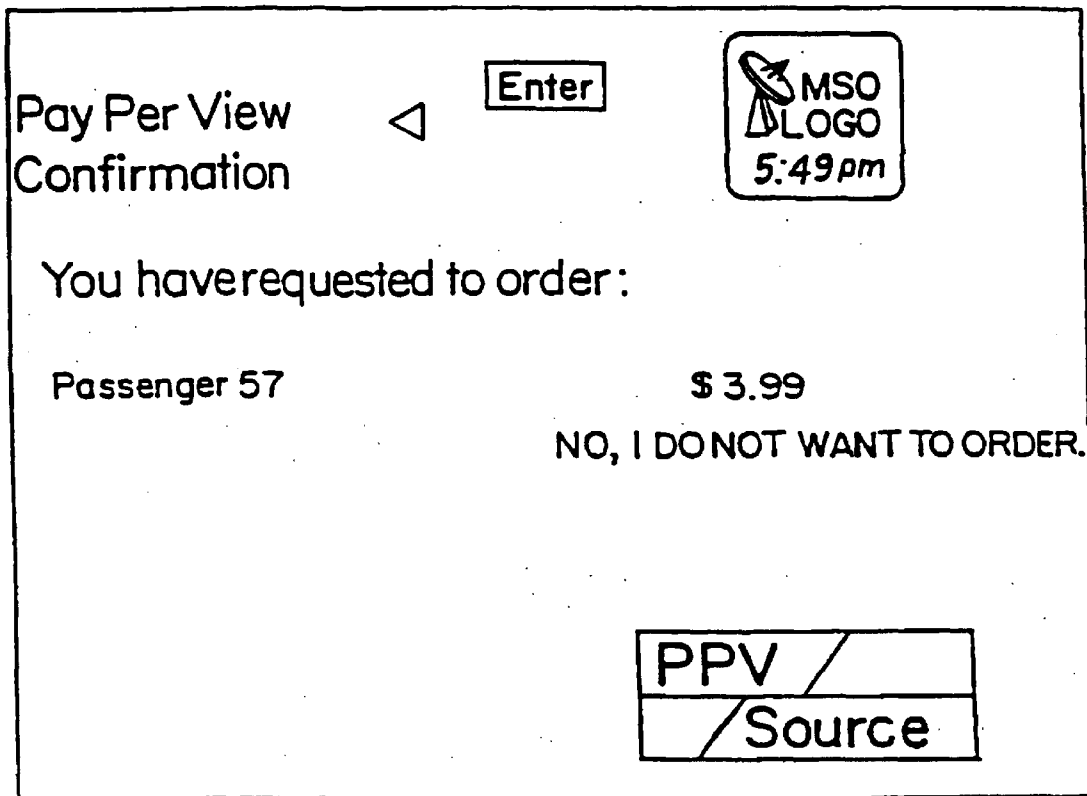

FIG.24



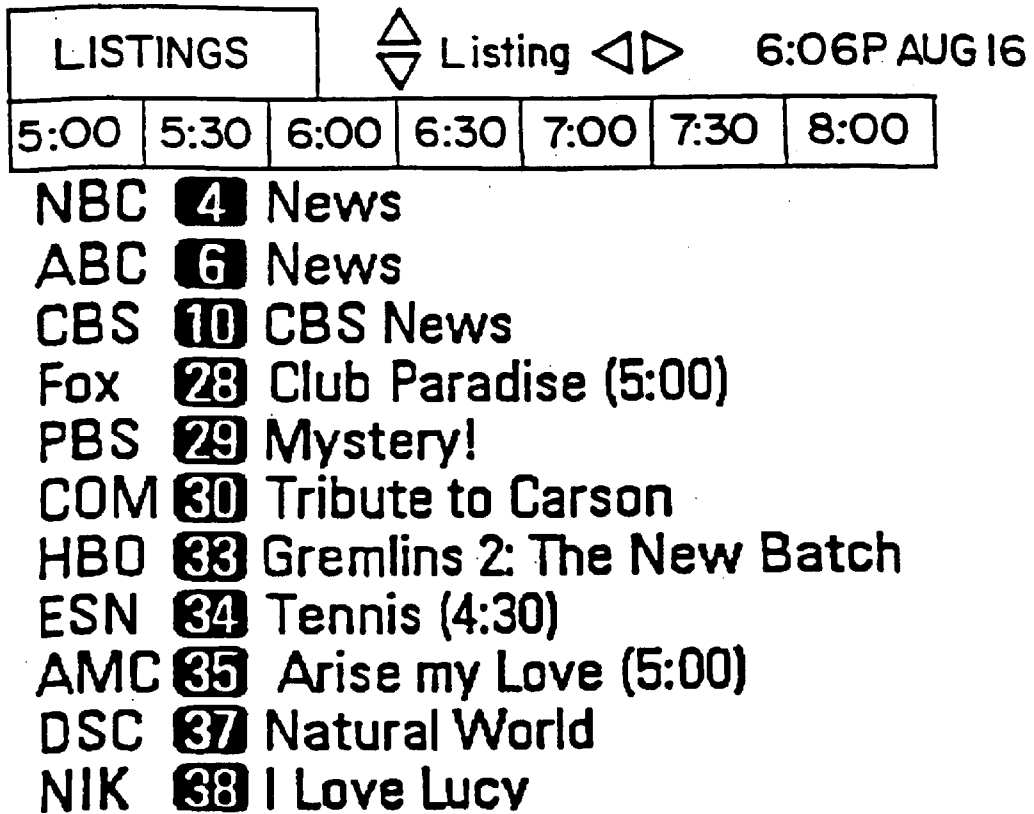

FIG.25



Premium Services	<input type="button" value="Enter"/>	
<input type="button" value="HBO"/>	Home Box Office \$10.40/Month	
<input type="button" value="SHO"/>	Showtime \$9.95/Month	
<input type="button" value="DIS"/>	The Disney Channel \$9.95/Month	
<input type="button" value="TMC"/>	The Movie Channel \$1.50/Month	
<input type="button" value="MAX"/>	Cinemax \$9.95/Month	
<input type="button" value="PLA"/>	Playboy at Night \$4.95/Evening(5:00pm to 3:00am)	
<input type="button" value="ACT"/>	Action \$5.95/Day(11:00pm to 3:00pm)	
Movie, special events, and family programming!		
You are not a Subscriber. Press <input type="button" value="Enter"/> to Subscribe!		

FIG. 26

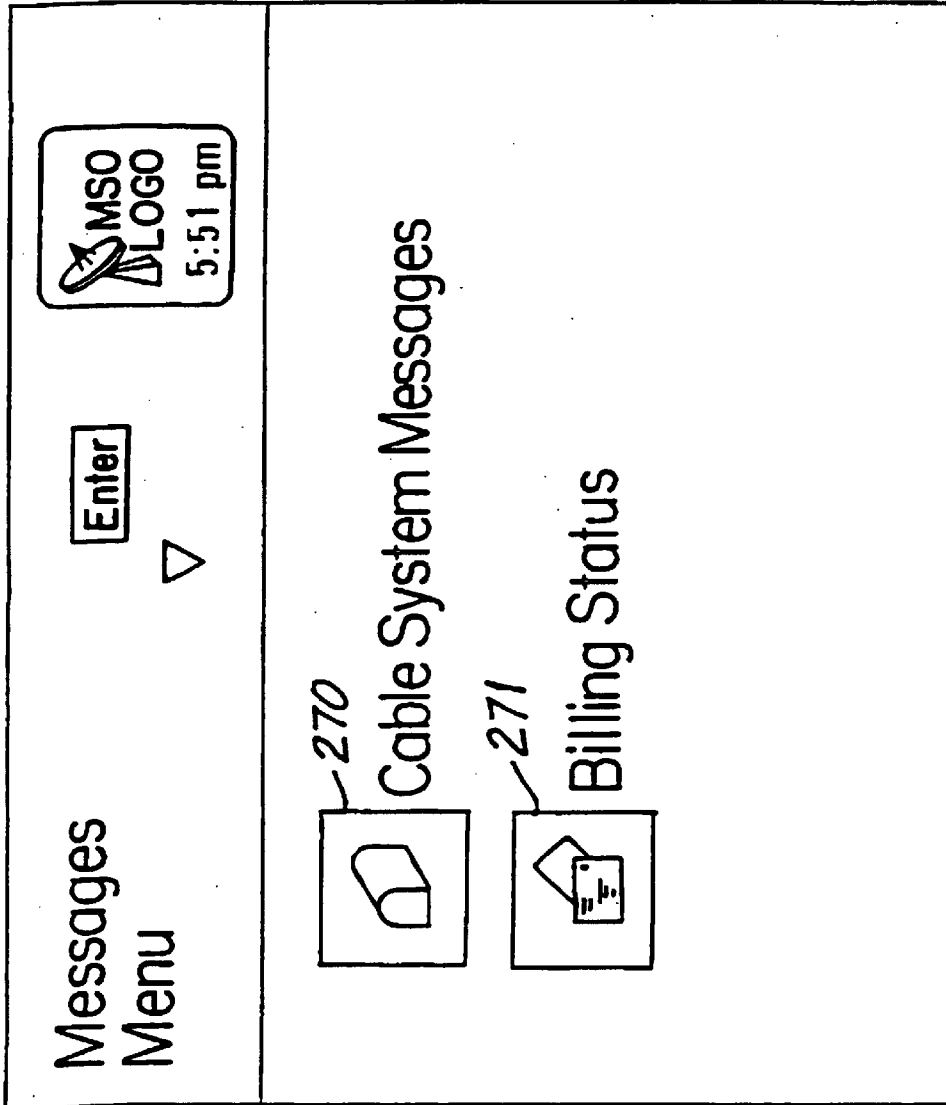

FIG.27

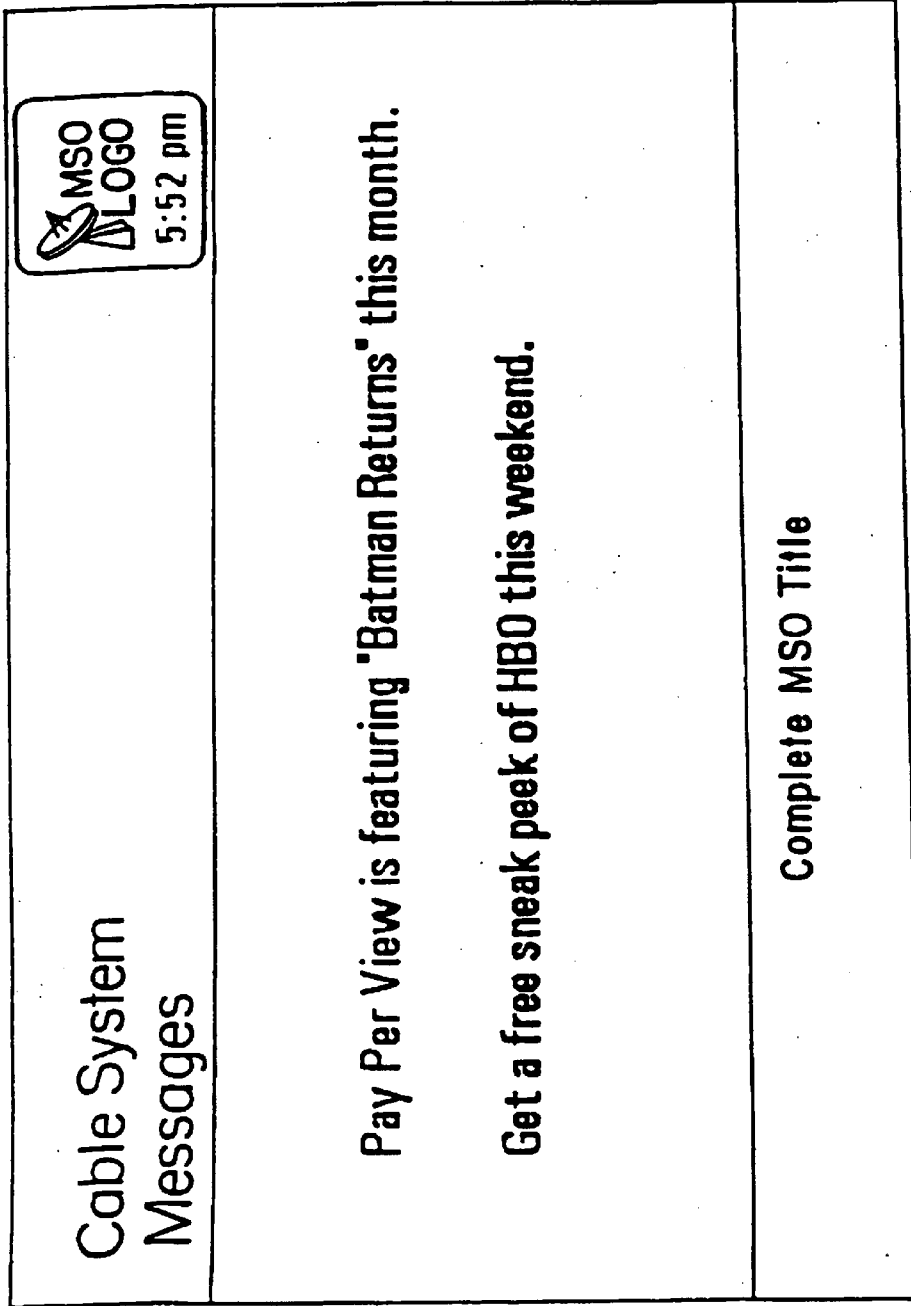





FIG.28





3/17	Free HBO Preview Tonight
3/22	Pay Per View Movie Sale Will be on Tonight only
2/28	New Channel Next Week on your Cable Network





12/23	California Earthquake Reeks Havoc on TV
3/25	President Clinton Address
3/30	PBS Pledge Drive Begins Tonight with Auction

To move between cable system and TV Guide mailboxes, use Left/Right arrows. To read messages, use Down arrow: when headline is highlighted, full message appears in this space.

FIG. 28A

**Billing**

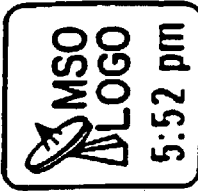

Name: TV Guide Onscreen Acct.#: 12345-098765-08-9

Billed From: 05/25/93 Billed To: 06/25/93 Total: \$3.99

FOR CUSTOMER SERVICE CALL: 790-0900

Date	Time	Service / PPV Event	Cost
06/07/93	9:00 p	PASSENGER 57	\$3.99

FIG.29

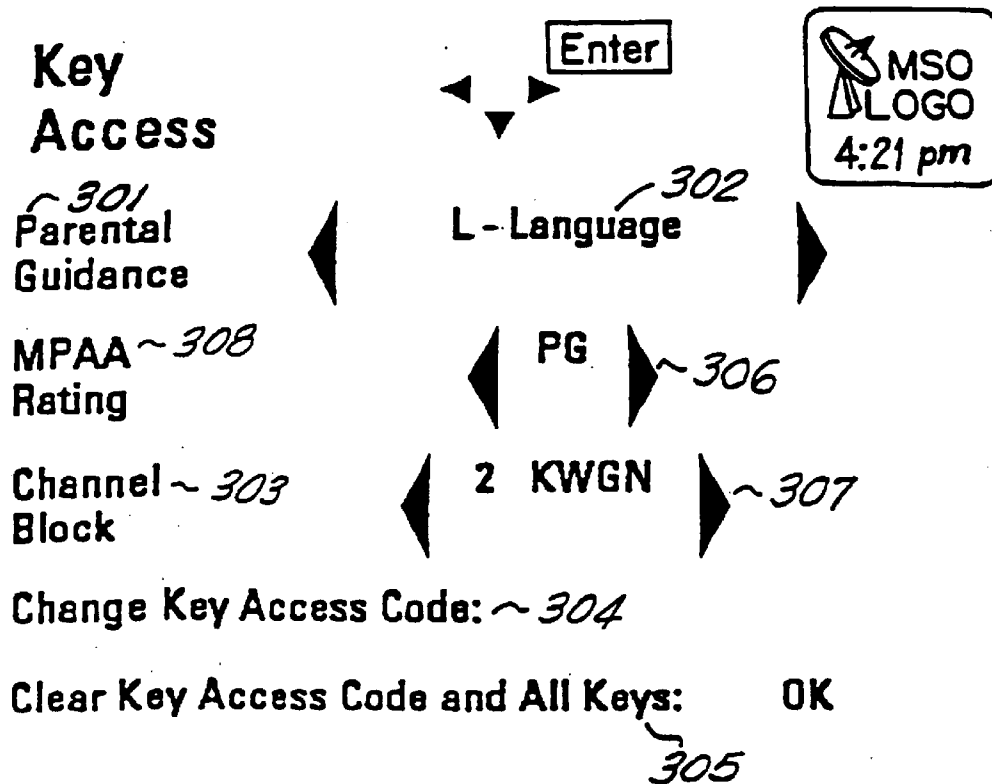

FIG.30

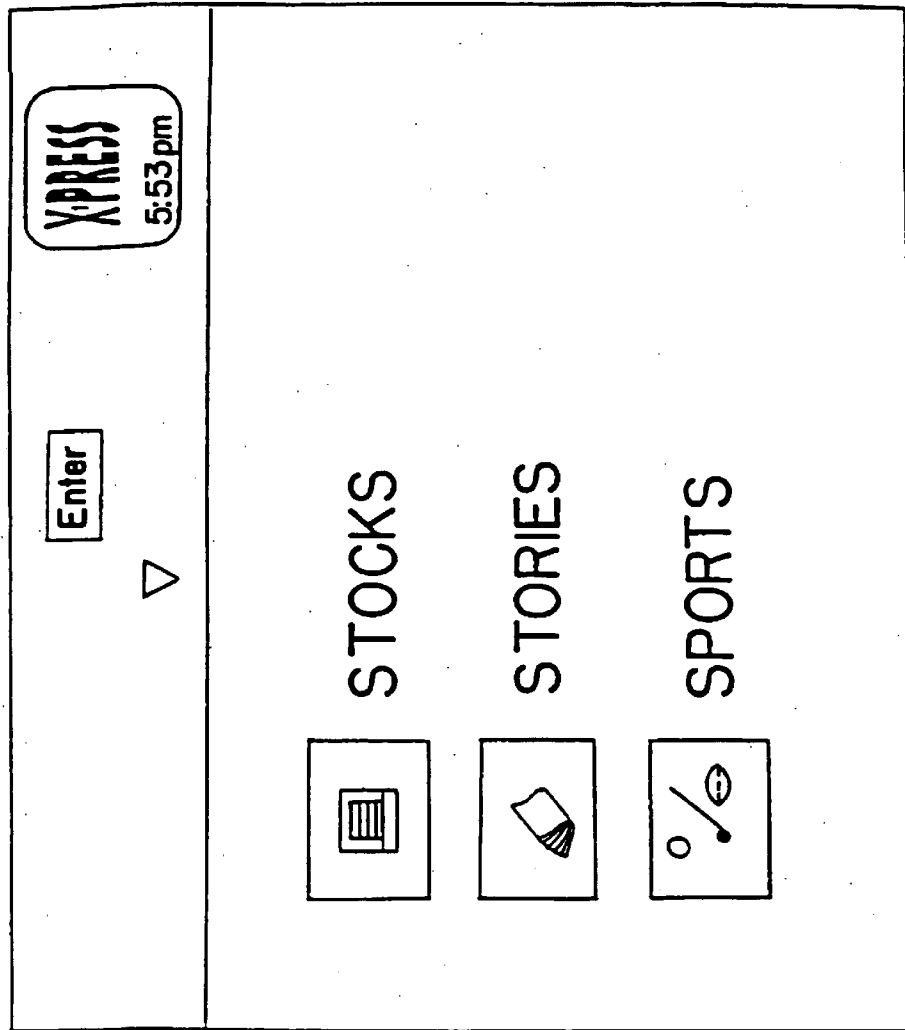

FIG. 31

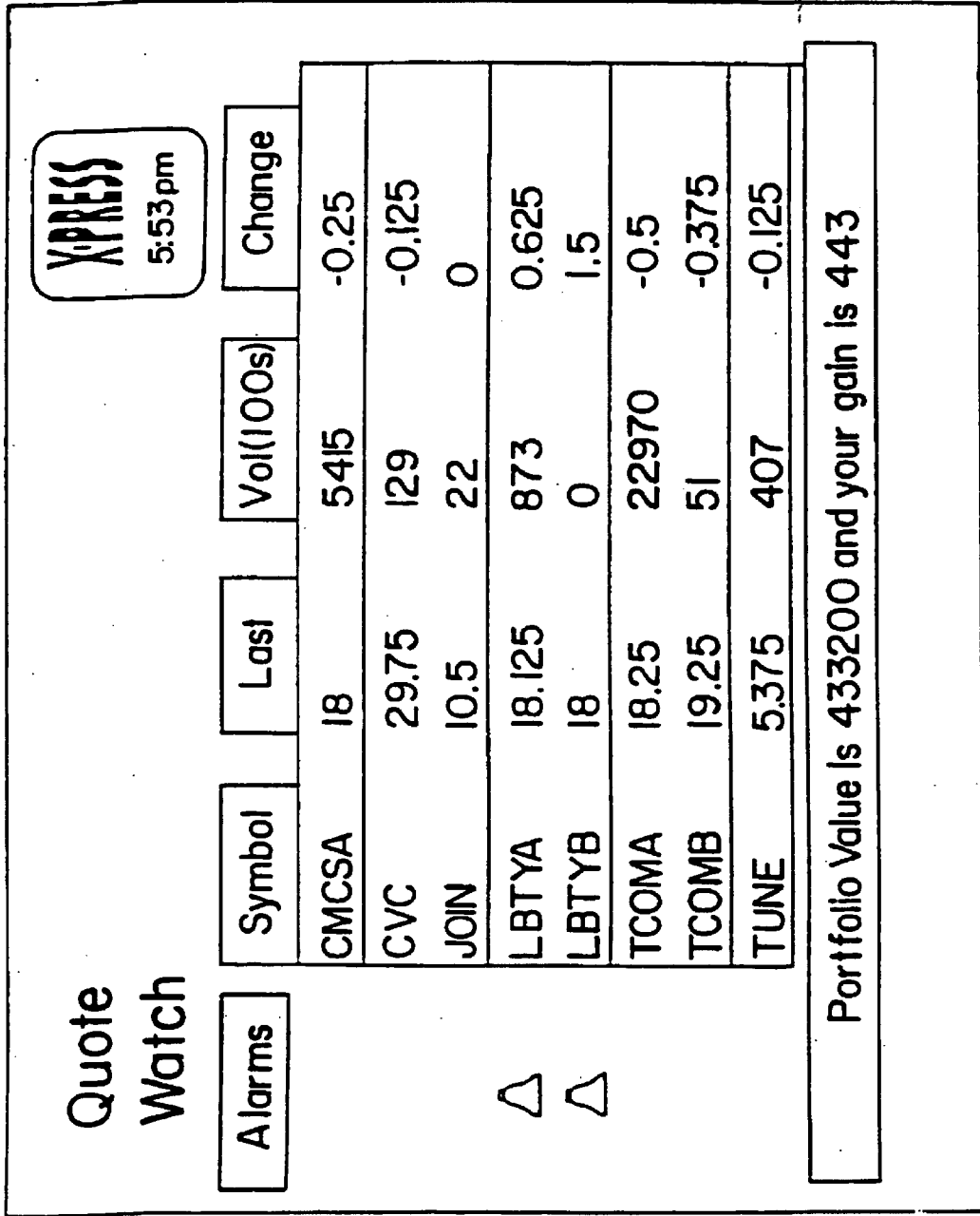

FIG. 32



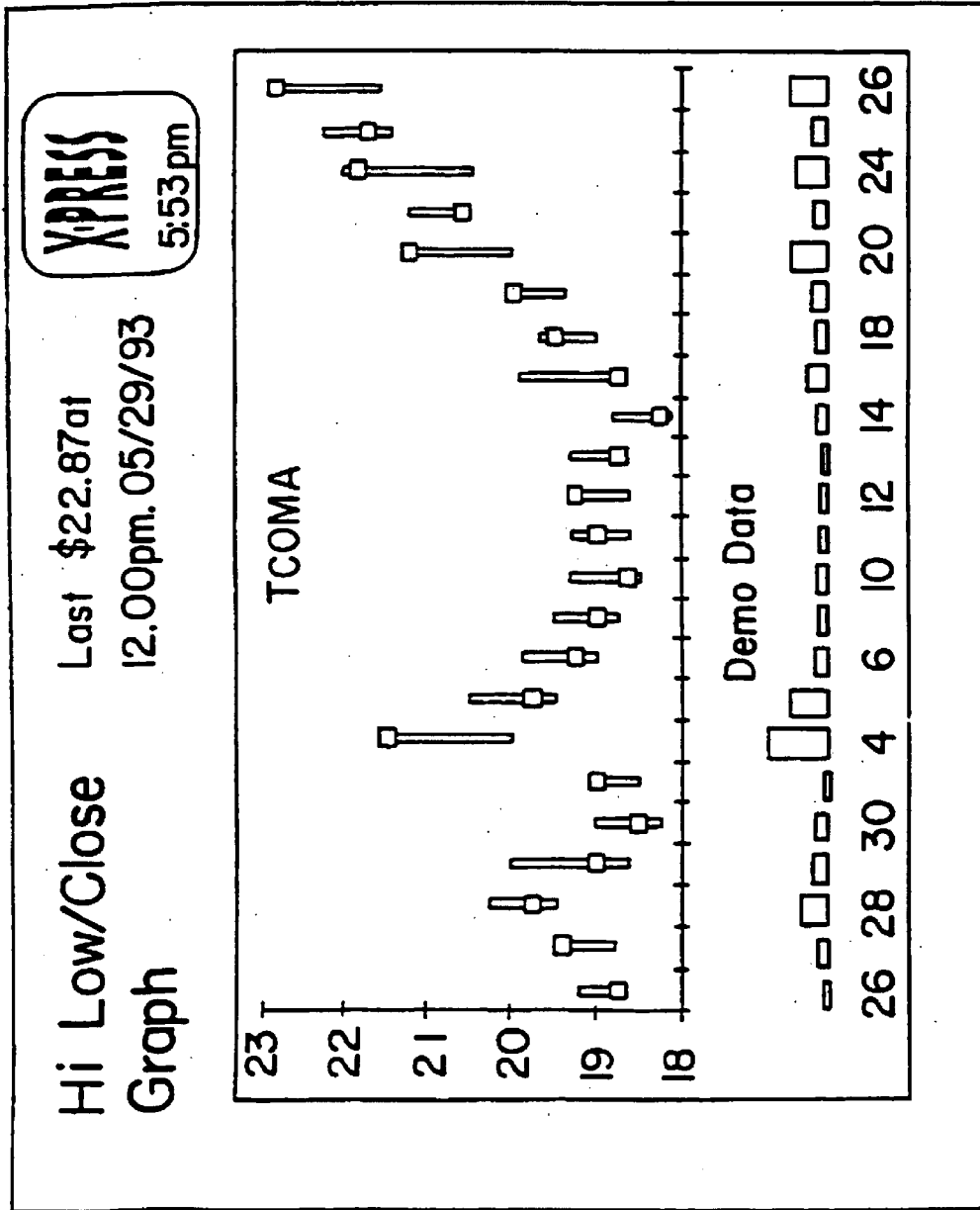

FIG. 33

STORIES



---

US World News

**Cubans use Vitamins to combat epidemic**

Geneva - A costly campaign to provide vitamins to all Cubans has helped curb a mysterious epidemic that has afflicted thousands with vision problems, a World Health Organization official said yesterday.

The outbreak of optical neuritis has dimmed the vision of about 20,000 Cubans and a related malady has affected 6,000 other people, mostly women.

FIG.34

SPORTS



---

Major League Baseball

Yesterday in National League Action

Colorado 7, Houston 5

San Francisco 5, Chicago 4

Yesterday in American League Action

Detroit 4, Boston 1

Toronto 4, Milwaukee 2

FIG.35

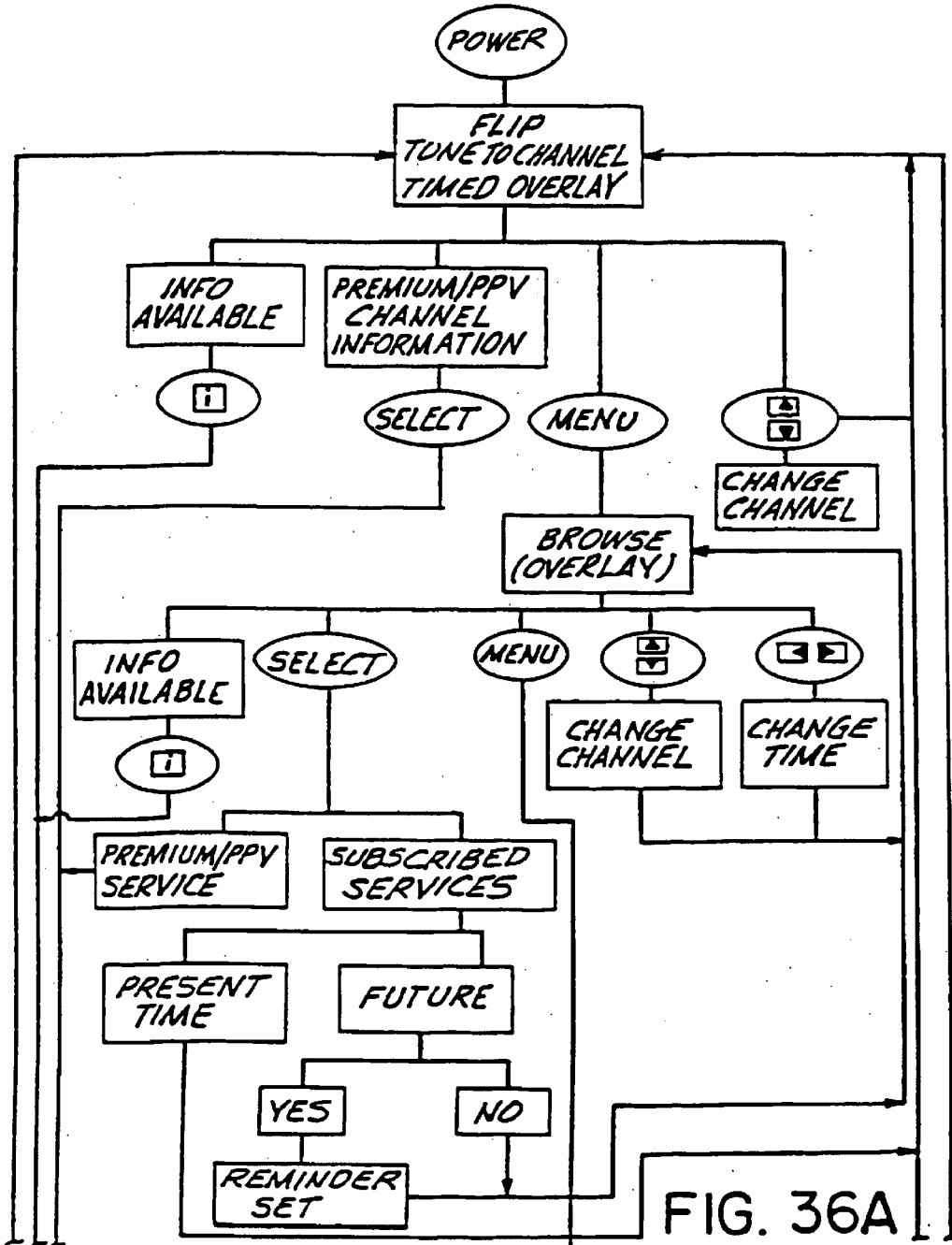

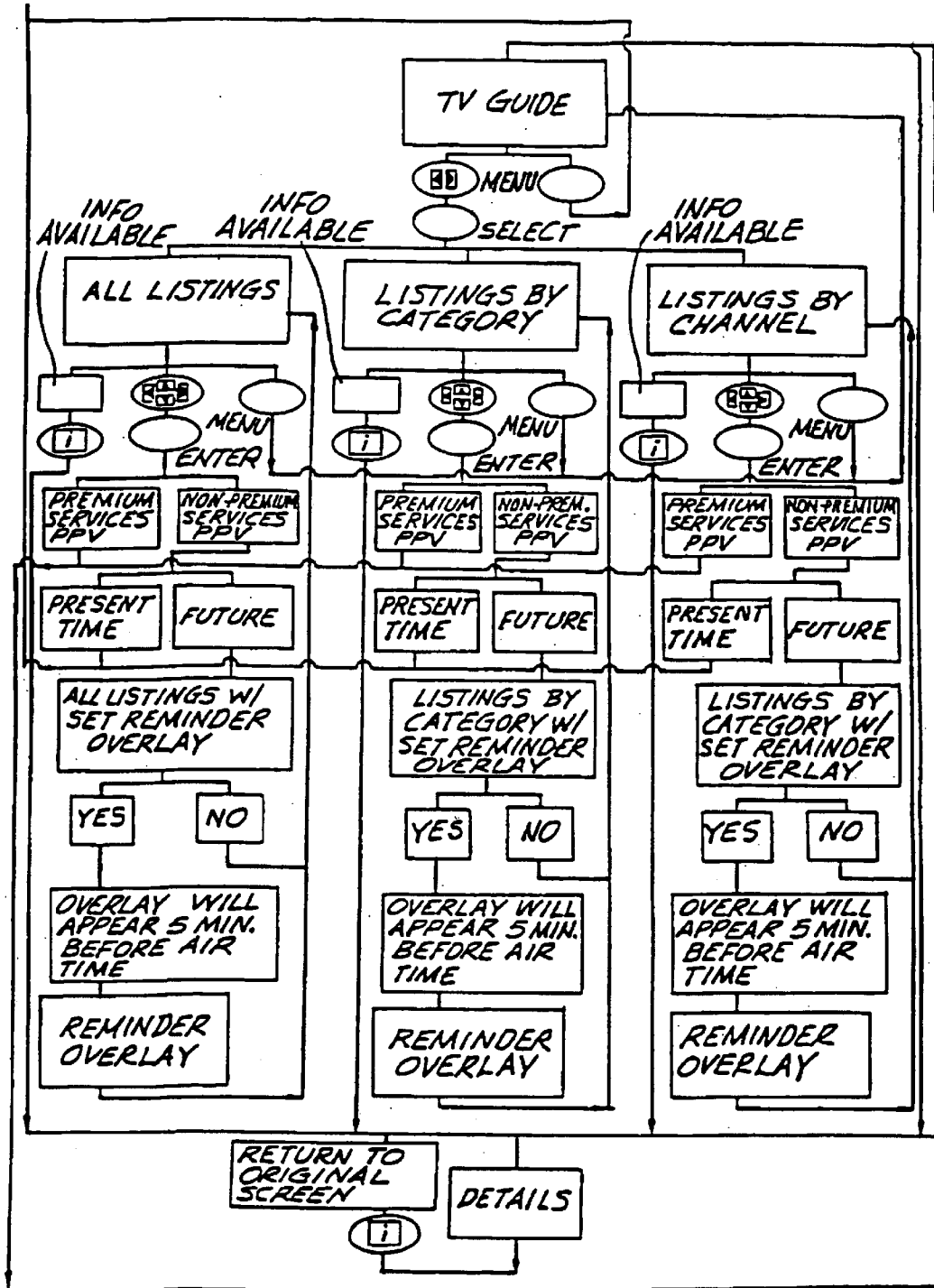

FIG. 36B

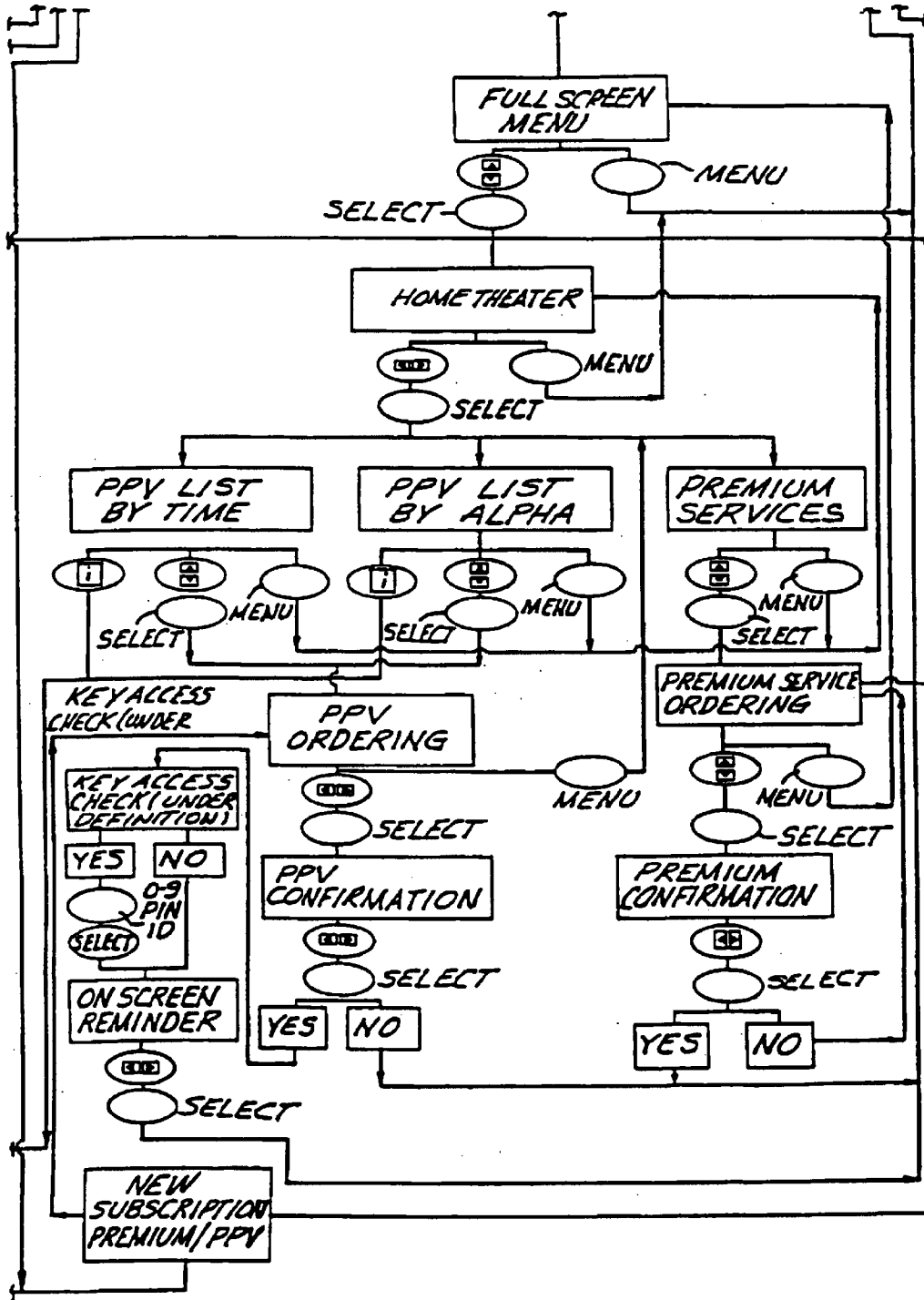

FIG. 36C

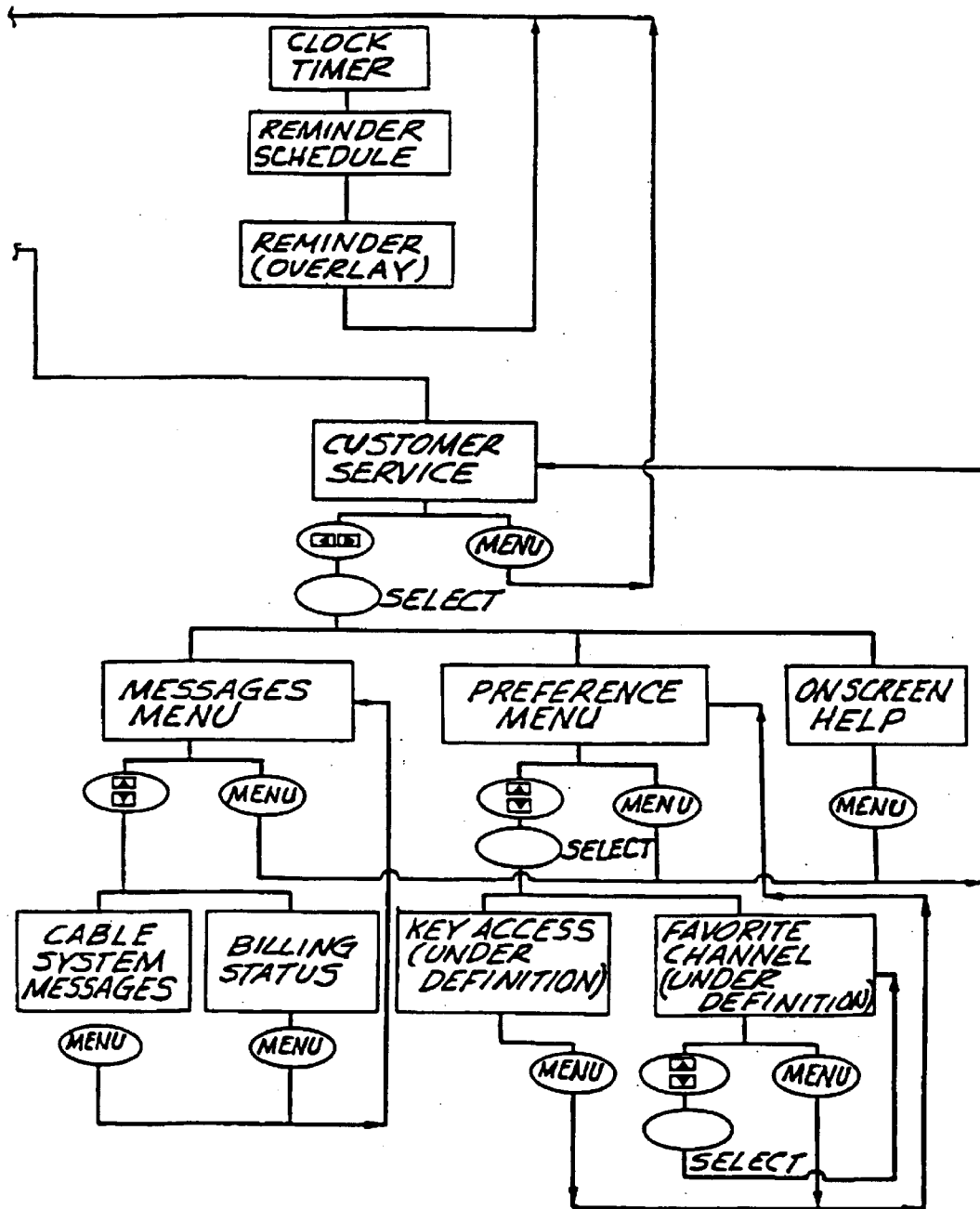

FIG. 36D

## ELECTRONIC TELEVISION PROGRAM GUIDE SCHEDULE SYSTEM AND METHOD

### BACKGROUND OF THE INVENTION

This invention relates to an electronic program schedule system, which provides a user with schedule information for broadcast or cablecast programs viewed by the user on a television receiver. More particularly, it relates to an improved electronic program guide that provides the user with a more powerful and convenient operating environment, while, at the same time, increasing the efficiency of navigation by the user through the guide.

Electronic program guides for television systems are known in the art. For example, one prior system used an electronic character generator to display textual schedule information on the full screen of a television receiver. Other prior systems presented electronically stored program schedule information to a user for viewing while allowing the user to select display formats. Still other systems employed a data processor to input user-selection criteria, then stored only the program schedule information meeting these criteria, and subsequently used the stored information to automatically tune a programmable tuner or activate a recording device at the time of broadcast of the selected television programs. Such prior systems are generally discussed in "Stay Tuned for Smart TV," published in the November 1990 issue of *Popular Science*.

Collectively, the prior electronic program systems may be difficult to implement and cumbersome to use. They also fail to provide viewing capabilities that address in a more realistic manner the viewing habits of the users of these electronic program systems. Moreover, many of these systems are complex in their design and are expensive to implement. Ease of use and economy are primary concerns of television program distributors and viewers as they contemplate dramatic increases in the number and nature of program networks and other television-based services. And, as the number of television channels available to a user increases dramatically with the advent of new satellite and cable-based technologies, the utility of these prior systems substantially diminishes.

These prior-art systems also fail to provide the user with sufficient information, for example pricing and the like, about pay-per-view events, premium services or other packaged programming to which the user does not subscribe, nor do they provide the user with the capability to automatically purchase such programming on demand or impulse. Moreover, these prior-art systems are deficient in that they fail to provide an efficient and automatic method of updating or replacing the application software programs that implement the electronic guide at the user sites, relying instead on manual or other cumbersome forms of revision or replacement or hardware-based systems that can not be updated without physical replacement of integrated circuits and/or other parts.

Nor do these prior electronic guide systems have the capability of linking the user to other applications or information systems which are not part of the electronic program guide application or data.

Nor do these prior electronic guide systems provide video promotion of television programs and services that are functionally linked and visually displayed in an integrated fashion. Program promotion is an important element of the effective marketing of television programming. The promotion of pay-per-view pay (i.e., "a la carte") programs and

other unregulated program services is particularly important to cable television operators in the wake of re-regulation by the federal government. The current method of promoting such programming using video is through dedicated "barker" channels that use full screen continuous trailers (i.e., previews) which may or may not be accompanied by prices and ordering information. Recently, such promotional videos have been shown in split screens where part of the screen shows general schedule information for a time period roughly corresponding to the time period during which the general program being promoted is shown. Accordingly, there exists a need for an electronic program guide which can provide improved display and linking of video promotions with program schedule information and order processing functions.

The prior electronic program guides also fail to provide the user with a simple and efficient method of controlling access to individual channels and individual programs. The amount of adult situations involving sex and violence has steadily increased during the last 40 years. The issue of how this affects children or other viewers has gained national attention. Providing a parent with the ability to lock-out a channel is a well known and widespread feature of certain television receivers and cable converter boxes. Despite this availability, the feature is seldom used by parents. The main impediments to its effective use are the cumbersome ways in which it is generally implemented, as well as the requirement that entire channels be blocked in order to block access to any objectional programming. A channel-oriented parental lock is unfair to other programmers on the blocked channel—who, for example, offer adult-oriented programming in the evening and youth-oriented programming the following morning—and inconvenient for viewers who want access to such programs. Thus, there is a particular need for a system which provides password control to individual programs and channels using a flexible and uncomplicated on-screen user interface.

The prior electronic program guides are also deficient in that they do not provide the user with the ability to view on demand current billing status and, thus, a need exists for a system which can provide the user with current billing information on the user's demand.

The prior electronic program guides also lack a method for creating a viewing itinerary electronically while still viewing a program currently appearing on the television receiver. Moreover, these prior program guides leave much guess work for the user as he navigates through a sequence of channels. When skimming through channels to ascertain the program then being displayed on any channel, commonly known as "channel surfing," the user needs to guess which program is currently being aired from the video encountered as the user surfs through the channels. Since much—in some cases, up to 30%—of the programming appearing on any given channel at any given time is advertising or other commercial programming, the user is not provided with any clues as to what program is appearing on a selected channel at a given time and must therefore wait until the advertisement or commercial is over before ascertaining the program then appearing on the selected channel. Thus a need exists for a program guide which displays current program schedule information for each channel as the user surfs through the available channels.

Accordingly, there is a need in the art for a simplified electronic program schedule system that may be more easily implemented, and which is appealing and efficient in operation. There is also a need to provide the user with an electronic program schedule system that displays both



broadcast programs and electronic schedule information in a manner not previously available with other electronic program schedule systems, particularly those using a remote controller.

For example, there is a particular need for a flexible program schedule system that allows a user to view selected broadcast programs on a portion of the screen of the television receiver while simultaneously viewing program schedule information for other channels and/or services on another portion of the screen. There is also a need for such a program schedule system that permits the user to select from a plurality of selectable display formats for viewing the program schedule information. It is also preferred to have a system that indicates to the user those keys on the remote controller that are active in any particular mode of operation. There also exists a need for such a system that will give a user the capability to set a programmable reminder for viewing a program scheduled to air at a future time.

There is also a need for an electronic guide system providing the user with comprehensive information about pay-per-view events, premium services or other packaged programming to which the user does not ordinarily subscribe, and which provides the user with the capability to automatically purchase such programming on demand or impulse. There is also a need for an electronic guide system providing a reliable and efficient method of updating or replacing the application software that implements the electronic guide at the user sites.

There also exists a need for an electronic program guide that operates as a shell or window to provide the user with the capability to access other applications or information systems that are not part of the electronic program guide application or data.

It is accordingly an object of the present invention to provide a system that will allow the user to view a broadcast program while, at the same time, interactively viewing program schedule information for other programs.

It is another object of the present invention to provide the user with the ability to select from among a plurality of display formats for the program schedule information.

It is yet another object of the present invention to indicate to the user of the program schedule system those keys on the remote controller active in the particular mode of operation of the system at the time of use.

It is a still further object of the present invention to provide the user of the electronic program schedule system with the capability of setting programmable reminder messages for any future program.

It is yet a further object of this invention to provide the system user with comprehensive information about pay-per-view events, premium services or other packaged programming to which the user does not subscribe and the capability to automatically purchase such programming on demand or impulse.

It is another object of the present invention to provide an electronic guide system that provides a reliable and efficient method of updating or replacing the application software programs that implement the electronic guide at the user sites.

It is still another object of the electronic program guide to operate as a shell or window to provide the user with the capability to access other applications or information systems which are not part of the electronic program guide application or data.

It is yet another object of the electronic program guide to provide a system whereby video promotion of television

programs and services are functionally linked and visually displayed in an integrated fashion to facilitate the marketing and sale of such programs and services.

It is still a further object of the present invention to provide password control for access to individual programs, as well as channels, using a protected interactive flexible and uncomplicated on-screen interface.

The disclosed system is also adapted to provide the user with current programming information for all programs as the user surfs through the available channels.

It is yet a further object of the present invention to provide a system in which the user can access his current billing information on demand.

These and other objects of the invention are achieved by an electronic program schedule system which includes a receiver for receiving broadcast, satellite or cablecast television programs for a plurality of television channels and a tuner for tuning a television receiver to a selected one of the plurality of channels. A data processor receives and stores in a memory television program schedule information for a plurality of television programs to appear on the plurality of television channels. A user control apparatus, such as a remote controller, is utilized by a viewer to choose user control commands and transmit signals in response to the data processor which receives the signals in response to user control commands. A television receiver is used to display the television programs and television program schedule information. A video display generator receives video control commands from the data processor and program schedule information from the memory and displays a portion of the program schedule information in overlaying relationship with a television program appearing on a television channel in at least one mode of operation of the television programming guide. The data processor controls the video display generator with video control commands, issued in response to the user control commands, to display program schedule information for any chosen one of the plurality of television programs in overlaying relationship with at least one television program then appearing on any chosen one of the plurality of channels on the television receiver.

#### BRIEF DESCRIPTION OF THE DRAWINGS

FIG. 1 is a block diagram showing various components of the preferred embodiment of the invention herein.

FIG. 2 is a block diagram showing the combination of program and schedule information by the video overlay device utilized in the preferred embodiment of the invention.

FIG. 3 depicts a remote controller that can be used in connection with the preferred embodiment of the electronic program guide system of the present application.

FIG. 4 depicts an alternative embodiment of the remote controller shown in FIG. 3.

FIG. 5 shows an overlay appearing on a television screen in one mode of operation of the preferred embodiment of the present invention.

FIG. 6 is a menu that appears on a television screen in a MENU mode of operation of the preferred embodiment of the present invention.

FIG. 6A is yet another menu that appears on a television screen in a MENU mode of operation of the preferred embodiment of the present invention.

FIG. 7 depicts a Viewer Preference Menu that appears on a television screen in one aspect of the preferred embodiment of the present invention.

FIG. 8 shows a Preferred Channel selection submenu.

5

FIG. 9 shows an impulse ordering menu that appears on a television screen in one aspect of the preferred embodiment of the present invention.

FIG. 10 shows a Premium Services submenu that appears in one mode of operation of the preferred embodiment of the present invention.

FIG. 11 shows a graphic overlay appearing on a television screen in a BROWSE mode of operation of the preferred embodiment of the present invention.

FIG. 12 shows a graphic overlay appearing on a television screen in a BROWSE mode of operation of the preferred embodiment of the present invention having different information from that shown in FIG. 11.

FIG. 12A shows a graphic overlay appearing on a television screen in a BROWSE mode of operation in the present invention displaying schedule information for a time and channel other than that shown in FIG. 11.

FIG. 13 shows a graphic overlay appearing in a REMINDER mode of operation of the preferred embodiment of the present invention.

FIG. 14 shows yet another graphic overlay appearing in a REMINDER mode of operation of the preferred embodiment of the present invention.

FIG. 15 is yet another menu that appears on a television screen in a MENU mode of operation of the preferred embodiment of the present invention.

FIG. 16 is yet another menu that appears on a television screen in a MENU mode of operation of the preferred embodiment of the present invention.

FIG. 17 is yet another menu that appears on a television screen in a MENU mode of operation of the preferred embodiment of the present invention.

FIG. 18 shows a grid listing of schedule information displayed in an All Listings mode of operation of the preferred embodiment of the present invention.

FIG. 19 shows schedule information displayed in a Listings By Category mode of operation of the preferred embodiment of the present invention.

FIG. 20 shows schedule information displayed in a Listings By Channel mode of operation of the preferred embodiment of the present invention.

FIG. 21 shows information displayed in response to a user's request for supplemental programming information.

FIG. 22 shows programming, ordering and video promotional information displayed in a Pay-Per-View mode of operation of the preferred embodiment of the present invention.

FIG. 23 shows an ordering submenu used in conjunction with the mode of operation shown in FIG. 22.

FIG. 24 shows yet another ordering submenu used in conjunction with the mode of operation shown in FIG. 22.

FIG. 24A shows yet another ordering submenu used in conjunction with the mode of operation shown in FIG. 22.

FIG. 25 shows another grid listing of schedule information displayed in an All Listings mode of operation of the present invention.

FIG. 26 shows a Premium Services submenu that appears in one mode of operation of the preferred embodiment of the present invention.

FIG. 27 shows a Messages menu that appears in one mode of operation of the preferred embodiment of the present invention.

FIG. 28 shows exemplary messages used in connection with the menu of FIG. 27.

6

FIG. 29 shows billing information used in connection with the menu of FIG. 27.

FIG. 30 shows a Key Lock Access menu that appears during one mode of operation of the preferred embodiment of the present invention.

FIG. 31 shows a menu appearing in connection with an Interactive Television mode of operation of the preferred embodiment of the present invention.

FIG. 32 shows information that appears in a Quote Watch menu in connection with the Interactive Television mode of operation shown in FIG. 31.

FIG. 33 shows other information that appears in connection with the Interactive Television mode of operation shown in FIG. 31.

FIG. 34 is a menu showing information that appears in a news display in the Interactive Television mode of operation of the preferred embodiment of the present invention.

FIG. 35 is a menu showing information that appears in a sports display in the Interactive Television mode of operation of the preferred embodiment of the present invention.

FIGS. 36A–D collectively form a flow chart showing the operational logic of a computer program that may be used to implement various aspects of the present invention.

## DETAILED DESCRIPTION OF THE PREFERRED EMBODIMENT

### System Configuration

FIG. 1 is a block diagram showing various components of the electronic program schedule system generally designated as 10. Physically, these system components can be located in a user's set-top cable converter box or other signal reception or processing device, such as a satellite receiver. Alternatively, the components can be mounted in a separate housing, or included as part of a television receiver, VCR, personal computer or multimedia player.

An input signal 11 is connected to a receiver 12, which receives a transmitted data stream from a data provider. The data stream may contain, for example, information about programs or services available in a particular market, geographical or otherwise. The input signal 11 can originate, for example, as part of a standard broadcast, cablecast or satellite transmission, or other form of data transmission. In the case of a cablecast transmission, the data provider is a local cable operator and the data stream contains program schedule information for all television programs and other services available in the operator's geographical market.

The data stream may be modulated and then transmitted on the cable line in any number of ways, including as part of a dedicated channel transmission operating at a frequency of, for example, 75 MHz. Those of skill in the art will understand that numerous other transmission schemes can be used to transmit the data stream, such as embedding it in the vertical blanking interval of a program broadcast signal. As will be discussed in greater detail below, according to the present invention, the transmitted data stream may additionally contain application software for implementing the electronic program guide at the user site.

The transmitted program schedule data or application software is received by the receiver 12 on signal input line 11. The received signal is passed from the receiver to a data demodulator 13, such as a QPSK demodulator, which demodulates the transmission and passes it to a buffer 15.

A microcontroller 16, such as a M68000EC, receives data passed to the buffer 15. Bootstrap operating software, which

may be used for capturing electronic program guide application software updates, is stored in a read only memory (ROM) 17. The microcontroller 16 uses the received program schedule information to build a database by storing the data in appropriately organized records in dynamic random access memory (DRAM) 18. The stored schedule information can be updated on a periodic basis, such as hourly, daily or weekly, or at any time when changes in scheduling or other factors warrant an update. The system also includes a system clock 19.

Alternatively, the program schedule information could be supplied in a ROM, disk or other non-volatile memory, or it could be downloaded to a storage disk or other data storage device. The invention herein is not directed to the particular method of transmission or reception of the schedule information.

If the microcontroller 16 recognizes the received data as application software which controls the program schedule system, as opposed to program schedule information, it stores it in non-volatile memory, such as an electrically erasable programmable ROM (EEPROM) 20 or battery-backed static RAM (SRAM). This configuration allows revised or replacement versions of the application software to be downloaded directly from the software developer to the user site through the cable or other transmission system.

In the case where an EEPROM is utilized, revised or replacement versions of the application software downloaded from the developer are first stored in DRAM 18 by the microcontroller 16, under direction of the downloading operating software stored in the ROM 17. The stored application software can then be checked for accuracy by, for example, a checksum analysis or other verification routine.

After the accuracy of the application software has been verified, the microcontroller 16 initiates a routine to re-program the EEPROM 20, where the application software is permanently stored. The microcontroller 16 will issue proper control commands to a reprogram circuit 21, which is adapted to supply the proper program voltage and logic control signals 22 required to erase and write to the EEPROM. It supplies this program voltage, Vprog, as well as any other required control signals, such as read or write enable, to the EEPROM 20 upon command from the microcontroller 16. After the EEPROM 20 has been electrically erased, the microcontroller 16 initiates transfer of the new application software from the DRAM 18 to the EEPROM 20 for storing.

When a battery-backed SRAM is utilized as non-volatile memory, the microcontroller stores the revised or replacement version of the application software downloaded from the developer directly in the SRAM, again under direction of the downloading operating software stored in the ROM. The stored application software can then be checked for accuracy by, for example, a checksum analysis or other verification routine.

When power is first applied to the system 10, the bootstrap operating software verifies that the program guide application software is resident in memory. If it is not resident, the bootstrap operating software waits for a download of the software. Once the application software is resident, the microcontroller 16 executes the application program software from a dedicated portion of the DRAM 18. Alternatively, the application software can be executed directly from the non-volatile memory 20. Under control of the program guide application software, the microcontroller 16 first verifies that the program schedule information is resident in DRAM 18. If it is not resident, the microcon-

troller waits for a download of the program schedule information, as discussed above.

When the schedule system is operating, as discussed in greater detail hereinbelow, the microcontroller 16 takes the program schedule information stored in the DRAM 18 and, in conjunction with other downloaded data types such as stored bit maps for the screen configuration and the graphic symbol or logo displays stored in non-volatile memory 20 or, alternatively, in DRAM 18, supplies it to a video display generator (VDG) 23, which in the present embodiment may be a commercially available VGA-type graphics card, such as a Rocgen card manufactured by Roctec. The VDG includes a standard RGB video generator 24, which takes the digital program schedule information sent by the microcontroller 16 and converts it to an RGB format in accordance with the bit map for the particular screen display then being presented to the user on the television receiver 27. The configuration of each screen is shown and discussed in greater detail in the System Operation section below.

The VDG also includes a Video Overlay Device 25, which accepts the RGB video input, as well as an input from conventional television tuner 28, such as a conventional tuner manufactured by General Instrument, which supplies a program signal in standard NTSC video format. The overlay device 25 converts and combines the RGB signal with the signal from the tuner 28, and produces a composite NTSC output signal containing both the program signal and the program schedule information, as shown in FIG. 2. This composite video signal is supplied to a modulator 26, shown in FIG. 1, which can be a modulator such as available from Radio Shack, and then to the television receiver 27, which the user keeps tuned to the modulated channel, for example, channel 3 or 4. The composite video signal can also be supplied directly to the television receiver 27 or other receiving device from the VDG through a video port 25A on the VDG.

The system components identified in connection with FIG. 1 can all be implemented in a preferred platform by, for example, an IBM personal computer equipped with a transmission link and a video graphics card, such as those manufactured by Roctec. Other platforms, such as a cable converter box equipped with a microprocessor and memory, could also be used. In any event, those of skill in the art will appreciate that the particular details of the hardware components and data storage are a function of the particular implementation of the system, and are not the subject of the present invention.

As discussed in detail below, the user may navigate through the program schedule system with a remote controller, such as that shown in FIG. 3, which operates on conventional principles of remote control transmitter-receiver logic, such as by infrared or other signalling, or other suitable user interface. The remote controller 31 communicates with the microcontroller 16 through the remote controller receiver 29, shown in FIG. 1, which can be a Silent Partner IR receiver and which receives signals transmitted by the remote controller 31 and supplies the microcontroller 16 with a corresponding digital signal indicating the key depressed by the user.

A remote controller suitable for the present invention, such as shown in FIG. 3, which can be a remote controller manufactured by Universal Electronics, may include a power switch 32, volume 33 and mute 34 controls, an ENTER key 35, 0-9 digit keys 36, four direction arrow keys 37A and 37B, a MODE key 38 and an information key 39 that is designated with a lower case "i." The power 32,

volume **33** and mute **34** keys operate in the same manner as conventional remote controllers typically used with present-day television receivers. The numeric digit keys **36** also function in much the same manner as conventional remote controllers. A brief description of the remaining keys follows.

The MODE key **38** takes the user through various layers of the electronic program schedule system **10** and generally allows the user to return to a previous screen when he is in a submenu. The up/down direction arrow keys **37A** allow a user to navigate through the different TV program channels when the program schedule system is in a FLIP or BROWSE mode, as will be fully described below, and also allow the user to navigate through highlighted bars displayed on the TV screen when in a MENU mode. The left/right direction arrow keys **37B** allow the user to navigate through selected time periods when the program schedule system is in the BROWSE mode, as will also be described below. They further allow the user to navigate across subject-matter categories while in the "Categories" submenu of the MENU mode, as well as to navigate across time periods when the program schedule system is in a pay-per-view ordering mode and, in general, navigate in left or right directions to select various icons and other objects. The information, or "i," key **39** allows the user to view supplemental program and other information during the various modes of the program schedule system. The ENTER **35** key fulfills and inputs a command once the user has made a selection from the remote controller keys. The function and operation of these keys will be made more apparent in the detailed discussion of the FLIP, BROWSE and MENU modes below.

A second embodiment of the remote controller **40** is shown in FIG. 4. This embodiment of the remote controller also includes a power key **41**, numeric digit keys **42**, direction arrow keys **43A** and **43B**, information key **48**, ENTER key **44**, volume control **45** and mute keys **46**. It also includes pound sign and star keys.

This embodiment of the remote controller further includes a number of icon keys **47A** and **47B**, which correspond to different submenus or modes of the program schedule system. The icons **47A** and **47B** may also be displayed on the TV screen when the program schedule system is operating. The icon keys essentially replace the MODE key **38** used in the embodiment of the remote controller shown in FIG. 3. Using these keys, the user can move from one mode to another simply by depressing the icon key corresponding to the desired mode of operation of the program schedule system. In the embodiment of FIG. 4, the icons **47A** and **47B** are shown as graphic symbols situated directly above a corresponding color-coded key. Alternatively, the color-coded keys could be eliminated and keys could be formed in the image of the icon itself.

The embodiment of the remote controller shown in FIG. 4 also includes three color-coded viewer preference keys, **48A**, **48B** and **48C** that are situated directly above the icon keys. Each of these keys indicates to the program schedule system a distinct user-created "Channel Preference" list, which is a listing of a specific subset of channels for a particular user, arranged in the sequential order that the user wishes to view during operation of the program schedule system. The creation of the Channel Preference list is discussed in the following section. Thus, the system provides for at least three individual channel subsets for three individual users.

Additionally, each of the functions of the remote controllers can also be integrated into a keypad on the user's cable box or other hardware.

## System Operation

In operation, the electronic program schedule system of the present invention functions as follows.

### FLIP Mode

When the user is viewing a particular program channel on the television receiver, the program schedule system defaults to a FLIP mode, shown in FIG. 5. In this mode, a graphic overlay **51** containing programming information for the channel currently tuned on the tuner is superimposed in overlaying relationship with a received program signal **55** on the screen of the television receiver **27** whenever the viewer changes the program channel, for example, by using the up/down direction arrows on the remote controller. The video overlay device **25**, such as shown in FIG. 1, combines the computer-generated RGB video-graphic overlay information with the NTSC-format program signal from the tuner **28**, and supplies an NTSC-format output signal, which includes the program signal from the tuner and the program schedule overlay information for viewing on the television receiver **27**.

The programming information contained in the graphic overlay **51** is supplied to the RGB video generator by the microcontroller. In FLIP mode, the microcontroller first searches the program schedule database in, for example, the DRAM **18** to retrieve the programming information for the currently tuned channel **52** corresponding to the current time; i.e., the time at which the user just turned on the television receiver for viewing. The microcontroller **16** then supplies the current channel and program information to the RGB video generator **24** which converts the digital data information to RGB format and supplies it to the video overlay device **25**.

In normal operation, the microcontroller **16** defaults to displaying all channels offered by the cable company prioritized by numeric order, which is determined by the broadcast channel position in the radio spectrum or the marketing judgments of local cable operators. Using a "Channel Preference" submenu, discussed below, the user can revise the content and/or sequential order of the channels presented to the television receiver **27**.

In general, if the user does not issue a change-channel instruction, or other command, from the remote controller **40** within a predetermined time interval while in the FLIP mode, the microcontroller **16** instructs the VDG **23** to remove the graphic overlay **51** from the television receiver, thus presenting only a program signal **55** to the television receiver **27** for viewing. The duration of the predetermined time interval is such that it allows the user sufficient time to read the programming information contained in the overlay. The duration of the predetermined time interval during which the graphic **51** overlay appears is stored in a location in non-volatile memory **20** addressable by the microcontroller **16**. The user can change the duration of the time interval, by first entering a Viewer Preference mode, and then selecting an "overlay interval" entry. The microcontroller **16** then causes a user prompt to be displayed on the screen which, for example, asks the user to select an appropriate time period for displaying in the graphic overlay on the screen. Using the numeric keys, the user can input an appropriate response, for example, a period between 5 and 60 seconds, and then depress ENTER. The new interval period is then read and stored by the microcontroller **16** in the overlay time interval location in memory.

If the user issues a change-channel command from the remote controller **40** before or after the predetermined

overlay period has elapsed, either by using the up/down direction arrows 43A, or by entering a desired channel number using the numeric keys 42 and then depressing the ENTER key 44, the microcontroller 16 will cause the tuner 28 to tune to the desired channel—either the channel immediately preceding or following the current channel when the up or down arrow 43A is used or the specific channel entered on the numeric key pad by the user—and will also search for and immediately cause to be displayed the current program information for that channel. Thus, as the user flips through the channels, the program schedule information for any selected channel automatically appears in the graphic overlay 51 while the actual program 55 appearing on the selected channel at the particular time occupies the remainder of the screen.

The system can also be configured to issue an error message, such as an audible beep or displayed text indicating an invalid key stroke, if the user depresses either the left or right direction arrow keys while in the FLIP mode.

#### BROWSE Mode

To initiate the BROWSE mode, the user depresses the MODE switch once while in the FLIP mode when using the first embodiment of the remote controller 31 shown in FIG. 3, utilizing the second embodiment of the remote controller 40 shown in FIG. 4, the user would depress the button below the BROWSE icon 47A.

In the BROWSE mode, the user is provided with the ability to scan through program schedule information for any channel, including, but not limited to, the channel being viewed, while at the same time continuing to view the TV program previously selected. As shown in FIG. 11, in this mode the graphic overlay information that appears in the FLIP mode is replaced with programming information for the channel being browsed, which may or may not be the channel currently being viewed by the user. After the user issues the command from the remote controller 40 to enter the BROWSE mode, a graphic overlay 111 is generated, as in the FLIP mode, with program schedule information for the currently tuned channel 112 and a textual BROWSE indicator 113 to remind the user of the currently active mode, as shown in FIG. 11.

If the user depresses either the up or down direction arrow on the remote controller 40 while in the BROWSE mode, program schedule information for either the prior or next channel is displayed in the graphic overlay portion 111 of the television receiver screen 27, while the tuner remains tuned to the channel program that appeared on the television receiver at the time the user entered the BROWSE mode, as shown in FIG. 12, and continues to so appear. Each successive depression of the up or down direction arrow key produces corresponding program schedule information for the selected channel. The graphic overlay may also include a small video window for showing the actual video signal of a currently aired program or a clip of a future program corresponding to the schedule information then appearing in the BROWSE overlay. In this way, the user can simultaneously scan program schedule information for all channels while continuously viewing at least one selected program on the television receiver. With the advent of sophisticated television receivers, it may also be possible to simultaneously display multiple broadcast programs on a single screen for viewing, or to split the screen to show, for example, broadcast programs in combination with advertisements. The BROWSE feature could be used in any of these situations.

If, at any time during scanning of the program schedule information in the BROWSE mode, the user desires to tune the television receiver 27 from the program channel currently being viewed to the program channel indicated in the schedule information in the graphic overlay, he simply depresses the ENTER button 44 and the tuner 28 will be tuned to that channel. If the user does not want to view another channel and wishes to exit the BROWSE mode, thus removing the graphic overlay with the program schedule information, he must depress the MODE key twice in the first embodiment of the remote controller 31. The first depression of the MODE key takes the user to the MENU mode, discussed below, and the second depression will take the user to the FLIP mode. Once in the FLIP mode, the graphic overlay will be removed after the duration of the time-out interval has passed. In the second embodiment of the remote controller shown in FIG. 4, the user toggles the BROWSE icon key to deactivate the BROWSE mode.

When the user first enters the BROWSE mode and begins scanning channels, the schedule information appearing in the overlay portion 111 describes the programs currently playing on any particular channel. In order to view programming information for later times, the user employs the left and right direction arrows 43B. As a consequence, the system will display future program schedule information for the particular channel previously selected by the up and down direction arrows, whether it is the channel currently being viewed or any other available channel. The schedule information presented includes the name of the program and program start/stop time. The instant embodiment of the system, in order to conserve memory, will not allow the user to view programming information for a time prior to the current time. The system could be easily modified to provide such information if adequate memory is made available.

When viewing program schedule information for a future time in the BROWSE mode, the displayed time of airing 121 of the particular show 122 is highlighted, as well as the channel number and service indicator 123, as shown in FIG. 12A. Such highlighted information reminds the user that he is viewing program schedule information for a future time. Also, when viewing program schedule information for a future time on any particular channel in the BROWSE mode, depression of the channel up direction arrow key on the remote controller 40 causes programming schedule information for the next channel to appear, which corresponds in time to the future time that was being viewed before the up key was depressed by the user. The channel down direction arrow key 43B functions identically in this mode.

If while viewing program schedule information for a future time in BROWSE mode the user depresses the ENTER key on the remote controller, the microcontroller 16 will instruct the VDG 23 to display a REMINDER overlay message 130 which, as shown in FIG. 13, is displayed as a second overlay 131 appearing above the BROWSE overlay 132. The REMINDER message 130 queries the user as to whether the system should remind the user, at a predetermined time before the start of the selected program, that he or she would like to view the selected program, as shown in FIG. 13. If the user responds affirmatively, the microcontroller 16 stores reminder data consisting of at least the channel, time and day of the selected program in a reminder buffer, which contains similar schedule information for all programs for which the user has set a reminder. At a pre-determined time before the selected program start time, for example, five minutes, the microcontroller 16 will retrieve schedule information, including title and service, based on the reminder data, and will instruct the VDG 23 to

13

display a REMINDER overlay message **140** on the television receiver **27**, as shown in FIG. **14**, to remind the user that he or she previously set a reminder to watch the selected program. The REMINDER message **140** contains the channel, service and start time. It also displays the number of minutes before the time of airing of the particular show and updates the display every minute until the time of airing. The REMINDER message **140** also displays a “TUNE” inquiry, which asks the user if she would like to tune to the selected program. As with the overlay display time period in the FLIP mode, the user can modify the time period before a selected program that the REMINDER message appears by entering the Viewer Preference mode and revising the time entry.

#### MENU Mode

Using the remote controller **31** shown in FIG. **3**, the user can enter the MENU mode from the BROWSE mode or from the FLIP mode by toggling the MODE button **38** once or twice, respectively. Using the remote controller **40** of FIG. **4**, the user would simply depress the key **47B** corresponding to the MENU icon.

Referring to FIG. **6**, in the MENU mode, the system **S** displays a plurality of menu items and icons, which correspond to and allow user selection of distinct program schedule information display formats, local cable system message boards and other on-line information services. Unlike in the FLIP and BROWSE modes, in the MENU mode no program signal from the tuner is displayed on the television receiver **27**. In the embodiment shown in FIG. **6**, there are four vertically selectable horizontal bars **61–64**, which are accessed using the up and down direction arrows **43A** on the remote controller **31** or **40**. At the extreme left of each bar, an identifying icon **61A–64A** is displayed, which identifies the information contained in that bar. In the embodiment of FIG. **6**, the “TV GUIDE” icon **61A** in the first bar corresponds to program schedule information from TV Guides® magazine, the “NOW SHOWING” icon **62A** in the second bar **62** corresponds to pay-per-view and premium service events, the “MSO Logo” icon **63A** in the third bar **63** corresponds to Customer Service or local cable company information messages, and the circular icon **64A** in the fourth bar **64** corresponds to other interactive services available to the user. As also shown in FIGS. **6** and **6A**, each bar also contains a textual description of its contents.

When the user first enters the MENU mode, the system defaults to selection of the program schedule bar. When a particular bar is selected, the textual description is removed and a plurality of icons are displayed adjacent the identifying icon. In FIG. **6**, the program schedule bar **61** is selected. Using the up or down direction arrow key on the remote controller **40**, the user selects a vertically adjacent bar. FIGS. **15–17** show, respectively, selection of the Pay-Per-View bar **62**, the Customer Service or Messages bar **63** and the Interactive TV services bar **64**.

Once a particular bar in the MENU screen is selected, the user can select a particular icon from the plurality of horizontally selectable displayed icons **65A–65C** by using the left or right direction arrow and the ENTER key on the remote controller **40**. Each icon contains a graphical symbol appearing in a background window of a particular color. When a particular icon is selected, it is offset from its background window and the color of the window changes. In FIG. **6**, the grid icon **65A** immediately adjacent the “TV GUIDE” icon in the first bar **61** is selected.

The function corresponding to each icon will now be discussed.

14

In the uppermost vertically selectable horizontal bar **61**, the first grid icon **65A** represents an “All Listings” mode in which the program schedule information is displayed in a grid listing, such as that shown in FIG. **18**. Alternatively, a single column grid-like display could be used, as that shown in FIG. **25**. In this format, the vertical y-axis identifies the channel number and service while the horizontal x-axis identifies the time. The screen display of FIG. **18** also contains in the upper left-hand corner a mode identifier **180**, in this case the notation “All Listings,” to remind the user of the current operating mode of the system. Directly underneath them ode display is a highlighted display **181** of the channel that the user was watching before entering the MENU mode. In the upper right-hand corner, a logo icon **182** appears in a window directly above a date/time identifier **183**, which alternatively displays the current date and time.

In the center of the screen display shown in FIG. **18** is a graphical Active Key Display (AKD) **184** which indicates to the user those keys on the remote controller that are active for that particular mode of the program guide display system. For example, in the screen display of FIG. **18**, the cursor can only move up, down or to the right. If the user were to depress the left direction arrow key on the remote controller at that point, the system would not carry out any function since the cursor can not move to the left. Thus, the left arrow key is not active so its image is not displayed on the AKD **184**. Similarly, since the system will only respond to a depression of the up, down or right direction arrow keys and the ENTER key, they are the only key images displayed on the graphical AKD **184**. The MODE key, though not displayed, is always active to change from one mode to another. When the user first enters the All Listings guide, the time listing begins by default at the half-hour immediately preceding the current time unless the current time is on the hour or half-hour, in which case the display begins with the particular hour or half-hour, and the channel listing begins at the last channel being viewed by the user before entering the MENU mode. For example, in FIG. **18**, the current time is displayed as 7:13 p.m., the time listing begins at 7:00 p.m. and the channel listing begins with channel **4**.

In the All Listings mode, a moveable highlighted cursor **185** is used to indicate the currently selected program to the user. The user manipulates cursor movement using the direction arrow keys on the remote controller **40**. Furthermore, the entire information display pages upward if the cursor is placed at the bottom of the screen and the down direction arrow is depressed, and similarly pages to the left if the cursor is at the extreme right side of the display and the right direction arrow is depressed. In this way, the user can navigate through the entire program schedule.

The folder icon **65B** immediately to the right of the All Listings icon in the top horizontal bar **61** of FIG. **6** identifies a “Category Listing” mode in which program schedule information is displayed and categorized by program content, as shown in FIG. **19**. The particular listing shown in FIG. **19** includes the categories of Movies, Sports, News and Children **190A–190D**. The database record stored for each listing contains a content-specific identifier so the micro-controller can search the database and categorize the information by content for purposes of displaying it in the Category Listing mode. As shown in FIG. **19**, the user can manipulate the cursor left or right to highlight any one of the categories which appear at the head of the listing. In FIG. **19**, the “Movies” category **190A** is selected. As shown, the user is given a display of all movies, prioritized by time and then alphabetically by title of show, beginning with the half-hour

15

immediately preceding the current time unless the current time is on the hour or half-hour, in which case the display begins with the particular hour or half-hour. The screen display shown in FIG. 19 also includes a textual description of the current operating mode of the program schedule system, as well as the graphic AKD 184, similar to that used in connection with the All Listings mode.

As with the All Listings mode, if the user highlights a show which is currently airing, he can immediately tune to that show by depressing the ENTER key on the remote controller 40. If the highlighted show is one that will appear at future time, the user is again given the option of setting a REMINDER message.

The triangular icon 65C at the far right of the TV GUIDE bar 61 in the display of FIG. 6 identifies a "Channel Listing" mode in which the program schedule information is categorized and displayed by channel, as shown in FIG. 20. The screen display shown in FIG. 20 again includes a textual mode identifier 201, the graphic AKD 184, and the window 15 including the logo icon 182 and alternating time/date display 183. At the head of the program listing is a list of several consecutive channels 202A-202C beginning with the last channel viewed by the user before entering the Channel Listing mode. The channel in the middle window 202B is highlighted and is the channel for which schedule information is displayed. The display identifies those programs appearing on the highlighted channel beginning with the half-hour immediately preceding the current time unless the current time is on the hour or half-hour, in which case the display begins with the particular hour or half-hour. The user can display further future listings by manipulating the cursor to the bottom of the screen and paging the display, as previously described. The user can also change the selected channel by manipulating the left or right direction arrow keys on the remote controller 40. When the user issues a change-channel command in this manner, the next consecutive channel will be displayed in the highlighted window 202B in the channel string at the head of the display, and schedule information for the newly selected channel will be displayed on the television receiver 27.

As with other modes, if a user wishes to tune to a highlighted program that is currently airing, he can do so by simply depressing the ENTER key on the remote controller 40, and if the user wishes to view a program that airs at a future time, the user is again given the option of setting a REMINDER message.

In each of the FLIP, BROWSE and MENU modes, a lower case "i" icon appears at a number of occasions in connection with certain program listings, such as movies, such as the "i" 203 shown in FIG. 20. Any time this icon appears, the user can view additional programming information, generally comprising a textual description of program content and/or other information related to the program, such as the names of cast members and the like, by depressing the "i" key 48 on the remote controller 40. An example of a display of such additional information is shown in FIG. 21.

The second horizontal bar 62 appearing on the screen in the MAIN MENU mode shown in FIG. 6 is the "Home Theater" Listing. It corresponds to Pay-Per-View events or services, specialized programming, and Premium Service programs. When this category is chosen by the user, the television receiver displays information as shown in FIG. 15. The first theater-ticket icon 150 that appears in this Home Theater bar identifies a format in which the Pay-Per-View events and premium services are displayed, as shown

16

in FIG. 22. As with other modes, the user can manipulate the cursor to highlight and select any particular show. Also, the user is can obtain additional information about the Pay-Per-View event or service by depressing the "i" key 48 on the remote controller 40. The Pay-Per-View menu screen display shown in FIG. 22 also includes a video display section 220 in which short promotional clips of current and future events and services can be shown to the user while the user is viewing the Pay-Per-View scheduling information. The display of FIG. 22 is bit mapped such that the advertising clips may be shown in the lower left quadrant of the screen. The clips may be shown randomly in the video display section 120 or, alternatively, the clip shown could correspond to the particular selected entry on the list of events, and would change automatically as the user navigated through the list.

When a user highlights a Pay-Per-View event or service by manipulating the cursor to the desired event or service using the direction arrow keys on the remote controller 40, he can order the event or service by depressing the ENTER button on the remote controller, thus linking schedule, promotional and ordering functions. If the user selects a particular Pay-Per-View event or service in this manner, the programming schedule system will next present to the user a Pay-Per-View ordering screen such as that shown in FIG. 23. The display includes a figure representing the cost of the event or service. The display also asks the user to choose from among a plurality of scheduled airing times 230A-210C, as well as whether the user would like to see a REMINDER message prior to the start of the Pay-Per-View event or service. The user responds to these inquiries by using the direction keys on the remote controller 40 to manipulate the cursor to the proper response and then depressing the ENTER key. After the user has ordered a Pay-Per-View event or service, the program schedule system will present the user with two ordering confirmation submenus, such as shown in FIGS. 24 and 24A. In either of these submenus, the user can confirm or cancel the Pay-Per-View event or service.

If the user confirms the order, the microcontroller 16 stores the Pay-Per-View ordering information in a location in memory. The ordering information can then be transmitted to the cable operator by the microcontroller 16 either by phone line or on the cable line where the system has two-way communication or other such interactive capability. Alternatively, a computer at the cable operator location can interrogate the memory where the microcontroller stored the Pay-Per-View ordering information. At the appropriate time, the cable operator supplies the Pay-Per-View event or service-and it is received by all users who have ordered the program.

The second icon 151 in the Pay-Per-View bar of FIG. 15 identifies a specialized broadcast, cable or satellite programming service to which the user has access via the electronic program guide. In this mode, the electronic program guide application software acts to connect the user, through an appropriate data transmission link, to the programming service, at which point the user interacts with the service. Alternatively, the electronic program guide provides the navigation software, including the menus and scheduling information, for the particular programming service. Such a service could be, for example, Your Choice TV ("YCTV"), a service offering reruns of highly rated broadcast and cable programs, in which case the icon may take a form suitable to identify YCTV. The programming available on YCTV is then supplied to the user via the programming guide system.

17

The last icon **152** appearing in the Pay-Per-View bar of FIG. **15** identifies a display format which lists all Premium Services offered by the cable operator, as shown in FIG. **26**. In this mode, the user can select for impulse ordering any one of the premium services by manipulating the cursor using the direction arrow keys on the remote controller and depressing the ENTER key. Similar to Pay-Per-View ordering, the system will present the user with a series of ordering displays and, if a service is ordered by the user, it will confirm the user's request using another other submenu. If confirmed, the microcontroller **16** will store the ordering information or transmit it directly to the cable operator. Once the order has been confirmed, the microcontroller can immediately allow the user access to the ordered premium service. In this manner, the user can order premium events or services on demand.

If, during FLIP or BROWSE modes, a user views a channel or schedule information for a service not subscribed to by the user, the microcontroller **16** causes an ordering submenu to appear instead of displaying a program signal along with the graphic overlay, as shown in FIG. **9**. This submenu indicates to the user that she does not currently subscribe to the selected service, and then asks the user if she would like to order the service. If the user responds affirmatively, the program schedule system takes the user to the ordering submenu discussed above. In this manner, the user can order premium events or services on impulse.

The third horizontal bar **63** in the MENU mode shown in FIG. **6** is the "Messages" or "Customer Service" listing. As shown in FIG. **16**, the first envelope icon **160** represents message information available from the cable operator. When the user selects the message icon, he is presented with a screen display of currently available messages, as shown in FIG. **27**. The display shown in FIG. **27** includes cable system messages **270** and billing information **271**. If the user selects the cable system messages option **270**, she is presented with a message pertaining to the local cable operator, such as that shown in FIG. **28**. If the user selects the billing status option **271** shown in FIG. **27**, she is presented with a display of current billing information, such as that shown in FIG. **29**.

The next icon **161** in the Customer Service information bar **63** of FIG. **16** identifies a "Viewer Preference" mode, which allows the user to create or revise a number of program schedule system operating parameters. Once selected, this display presents the user with several preference options concerning certain operating parameters of the program schedule system, as well as the viewing of certain channels and/or certain content-specific programming, for example, those shown in FIG. **7**.

The first option shown in FIG. **7** is the "Parental" option **70**, which can also be expressed as a "Key Lock Access" option. Once this option is initially selected by the user, the system displays a "Key Lock Access" submenu such as that shown in FIG. **30**.

The Key Lock Access menu shown in FIG. **30** allows the user to control access to individual channels and programs or events by requiring the user to enter an access code "key," consisting of a user-specified four digit code in the specific embodiment discussed herein, before ordering or viewing these pre-selected channels, programs or events. The menu display shown in FIG. **30** shows a series of subject categories that are entries in the vertical y-axis selectable by the user. A particular subject category is chosen by using the up or down direction arrow keys on the remote controller **40** to highlight the desired entry. Once the user selects a particular

18

subject category, the left and right arrow keys are used to navigate within the chosen category.

The first subject entry shown in FIG. **30** is the "Parental Guidance" category **301**. Once the user selects this category by manipulating the cursor to highlight the entry, the cursor can be then moved horizontally to an active window **302** which displays and selects one the five letter rating items in the category. The letter items represent ratings of program content as follows: "V" for violence, "N" for nudity, "L" for language, "AS" for adult situations and "PD" for parental discretion. Once the user selects a particular item, such as "L", by moving to the active window **302** using the right direction arrow key, depressing the ENTER key will indicate to the microcontroller **16** that a key lock access has been selected for programs rated with a "L" rating for violent or explicit language. The system indicates activation of a key lock access by displaying a key icon directly below the "L" category display. Once a key lock access is set, it can be deactivated by selecting the category letter and then depressing the ENTER key. This action causes the key icon to disappear. The user can change the rating category in the active window **302** by using the left or right direction arrow keys on the remote controller **40**, images of which are displayed on the screen adjacent the active window as a reminder to the user. In this manner, the user can select other rating categories for setting a key lock access for any of the program content identifiers appearing in the Parental Guidance category.

The key lock access code itself consists of a four digit code, which the user can enter and modify at any time. To do so, the user highlights the fourth vertically selectable entry "Change Key Lock Access Code," **304** by manipulating the cursor to highlight it using the direction arrow keys on the remote controller. Once highlighted, the user enters a new four digit code or revises the then existing code and depresses the ENTER key. The microcontroller **16** then identifies the new four digit key lock access code and stores it in memory. The user can clear the key lock access code, as well as all other previously activated keys, by moving to the last entry in FIG. **30**, "Clear Key Lock Access Code and All Keys," **305** which highlights the "OK" window, and then depressing the ENTER key. This action clears and deactivates all previously set keys, as well as the key lock access code.

The schedule information database record for each program contains a field that corresponds to the program content identifiers in the Parental Guidance category. During operation, the microcontroller checks this field in response to a user command to tune to or order a program, or to display its corresponding schedule information before carrying out the tuning, ordering or displaying function. If the parental guide identifier in the program schedule information database record matches any one of the activated parental guidance identifiers shown in FIG. **30**, the user will be prompted to enter the four digit key lock access code before the system takes any further action. If the entered code matches the key lock access code previously entered and stored by the user as described above, the system will carry out the user request to tune to the program, to order it, or to display its corresponding schedule information. If the code is not recognized by the system, no further action will be taken and the user's request will be denied.

By manipulating the cursor using the direction arrow keys to highlight the second entry, "MPAA ratings," **308** the user can also set a key lock access for programs based on their MPAA rating code, as also shown in FIG. **30**.

As with the Parental Guidance category, once the MPAA rating category has been selected, the user can move hori-



zontally within the category to the active window **306** to select one the five rating codes, i.e., “G” for general audiences, “PG” for parental guidance, “PG-13” for suggested parental guidance, no one under 13 admitted without an adult, “R” for restricted and “X” for x-rated. As with the Parental Guidance category, by selecting a particular rating—by using the left or right direction arrow keys until the particular rating code appears in the active window—and then depressing the ENTER key, the user sets a key lock access for the rating, in which case a key icon appears below the rating code. And, as with the Parental Guidance category, once a key lock access is set, the system will prompt the user to enter the four digit key lock access code anytime a request is made to tune to, order or display schedule information for a particular program having a rating code which matches a rating code for which key lock access has been activated.

The Key Lock Access mode also includes a subject category **303** for controlling access to channels, which may be entitled, for example, “Channel Block” or “Channel Lock.” As with the Parental Guidance **301** and MPA **308** categories, the user navigates to the Channel Block category **303** by manipulating the cursor using the direction arrow keys on the remote controller and depressing the ENTER key. Once the Channel Block category **303** has been entered, the user can move horizontally to an active window **307**, which in FIG. **30** indicates channel **2**. Once the user highlights this window by manipulating the cursor using the direction arrow keys on the remote controller **40**, a key lock access can be set for the channel appearing in the active window. This is done, as with the other subject categories in the Key Lock Access mode, by depressing the ENTER key, which again causes a key icon to appear below the channel number in the active window. The user can move to the prior channel or to the next channel in sequence by depressing either the left or right direction arrow key on the remote controller **40**. In this manner, the user can activate a key lock access for any available channel.

As with the Parental Guidance **301** and MPA **308** categories, once a key lock access is set for a particular channel, the system will prompt the user to input the key lock access code prior to carrying out an instruction to tune to or order that channel. If the input key lock access code matches the previously stored access code, the user’s instruction is carried out. Otherwise, the user’s instruction is ignored. Thus, the user can control access to the audio and video program content of any available channel. In this instance, the microcontroller **16** will not allow audio or video program signals to pass to the VDG, but it will allow schedule information to appear for the channel.

The next option shown in FIG. **7** is the Channel Preference or “Favorite Channel” list option **71**. By highlighting this icon and depressing the ENTER key on the remote controller **40**, the user is presented with a submenu on the screen such as that shown in FIG. **8**.

In normal operation, the program guide system presents channels to the user in numerical order in response to an up or down change-channel command issued by the user using one of the direction arrow keys on the remote controller. The channel number presentation sequence includes all channels offered by the cable company in the order of which they are modulated onto the channel by the operator.

The program guide system also provides the capability of selecting from among several user-defined channel presentation sequences, which are activated using one of the three “check mark” icon keys **48A**, **48B** or **48C** on the remote controller **40** shown in FIG. **4**. Each of these keys represents

a preferred particular list of channels which a particular user selects and which the microcontroller stores in memory as a “Channel Preference” list, as discussed in detail below. To activate one of these preferred channel lists, the user depresses the corresponding check-mark icon key, in which case the microcontroller may display the chosen icon on the screen in the graphic overlays and full screen displays to remind the user that a particular channel preference list is being used by the system. Once a preference list is activated, the system will limit the tuning of the television receiver and the display of schedule information only to those channels that are designated in the activated viewer preference list.

To revise the content and/or sequential order of the channels in the Channel Preference list, the user enters the MENU mode of the programming guide system. To enter the MENU mode from the FLIP mode, the user twice depresses the MODE key **38** when using the remote controller **31** of FIG. **3**. To enter the MENU mode when using the alternative embodiment of the remote controller **40** of FIG. **4**, the user simply depresses the MENU icon key **47B**.

When first entered, the MENU mode has a screen display such as shown in FIG. **6**. To select the submenu for editing the Channel Preference list, the user first selects the third horizontal bar **63**, which can be titled, for example, “Messages” or “Customer Service,” by manipulating the cursor using the down direction arrow key, as shown in FIG. **7**. The screen of FIG. **6A** is thereby displayed. The user then selects the second icon **161** appearing in that bar, indicated with a check mark, which corresponds to a “Viewer Preference” mode, by highlighting the icon using the direction arrow keys and again depressing the ENTER key. This action will cause the microcontroller **16** to display a Viewer Preference submenu such as that shown in FIG. **7**. By selecting the Channel Preference or “Favorite Channel” entry **71**, the user enters the Channel Preference submenu, shown in FIG. **8**. If the user has not already done so, he would then depress the particular check-mark icon key on the remote controller **40** of FIG. **4** to create or revise the particular channel preference list.

In the Channel Preference menu shown in FIG. **8**, a list **80** of all channels available on the particular cable system is displayed on the left side of the television receiver screen, labeled “Choices” in FIG. **8**, and the viewer’s preferred list **81**, designated “Selected” in FIG. **8**, is displayed on the right side. If a particular code, such as an END or “-1” symbol appears in the first (uppermost) position **82** of the viewer preference list **81**, the system displays information for all channels in numerical order in all modes of operation. This is the default mode of the system.

By selecting channels in sequence from the available list **80** and placing them in the desired order in the preference list **81**, the user can select a subset of channels and/or rearrange the default sequence in response to a channel up or channel down command from the user. This is accomplished by highlighting a channel in the available list **80** using the up and down direction arrow keys on the remote controller **40** and depressing the ENTER key **44**, which stores the entry temporarily in a buffer.

The microcontroller **16** stores a list of all channels previously entered in the viewer preference list **81**. As a particular channel is highlighted by the user when navigating through the available channel list **80** displayed on the left side of the television screen, a window **84** appears adjacent to the particular channel highlighted by the user. If the particular channel already appears in the viewer preference list **81**, the system displays a “DELETE” message in the

window **84** as a reminder that the channel was previously selected from the available channel list **80** and can only be deleted from the list **81**, which is accomplished by depressing the ENTER key **44**. If the particular highlighted channel in the list **80** was not previously selected, the system displays a "SELECT" message in the window **84** as a reminder that the particular channel will be selected for addition to the viewer preference list **81** if the user depresses the ENTER key **44**. The microcontroller **16** inserts a selected channel at the bottom of the list **81**. In this manner, the user can select or delete channels from the viewer preference list in any desired order.

The available channel list **80** may also be provided with categorical entries **83**, such as movies, news, sports or children's shows. The user may also highlight any of these entries and put them into the viewer preference list **81**. If the user does include a category in his viewer preference list **61**, when the user issues channel up or down commands, the system will display, in sequence, first the user's selected preferred channels in numerical order and then all channels having a program whose content corresponds to the selected category or categories at the time.

Once the user has revised the channel preference list **81** in the described manner, the microcontroller **16** will follow the stored user-specified channel sequence in response to a change-channel command made by the user employing one of the direction arrow keys. To activate the viewer preference list, the user depresses one of the three check-mark icon keys **48A**, **48B** or **48C** on the top of the remote controller shown in FIG. **4**. The viewer preference list can be used to selectively limit tuning of the television receiver or display of schedule information in any of the operating modes of the electronic program guide. In the present embodiment, once a preference list is activated, the system will limit the tuning of the television receiver and the display of schedule information in the FLIP, and BROWSE modes, as well as in the grid category and channel listings in the MENU mode, only to those channels designated in the activated viewer preference list. The tuner can not be tuned to, and no corresponding schedule information can be displayed for, any channel not entered in the viewer preference list when it is activated. In this regard, it should be noted that setting a key lock access in the Parental Guidance **301**, MPAA **308** or Channel Block **303** categories produces a different result than when using other display criteria, such as the Channel Preference List of preferred channels discussed above. Thus, while a key lock access will prevent audio and video program information, but not schedule information, from being displayed or ordered absent entry of an authorization code, if a particular channel is included in the Channel Preference list and also has a key lock access activated in the Channel Block category **303** of the Key Lock Access mode, that channel or its corresponding schedule information will not be displayed at any time.

To deactivate a previously selected viewer preference list, the user toggles the appropriate check-mark icon key on the remote controller **40** of FIG. **4**. Once deactivated, the system defaults to displaying and tuning all available channels, as well as displaying schedule information for all available channels.

Alternatively, the viewer preference list **81**, if activated, can be used to control tuning and display of schedule information only in selected modes, such as only in the FLIP mode, thus allowing the user to tune and view corresponding schedule information only for those channels entered in the preference list **81** in the FLIP mode, while viewing all channels and corresponding schedule information in all other modes.

In this latter configuration, as well as in the instance where no channel preference list is activated and the system is in default mode, if a channel appears in the viewer preference list **81** that corresponds to a service not subscribed to by the user, the microcontroller **16** causes an ordering submenu to appear instead of displaying a program signal along with the graphic overlay, as shown in FIG. **9**. This submenu indicates to the user that he does not currently subscribe to the selected service, and then asks the user if he would like to order the service. If the user responds affirmatively, the program schedule system takes the user to another ordering submenu to confirm the user's request, as with impulse ordering.

In addition to Channel Preference keys, the remote controller **40** can also be supplied with a number of user-activated category preference icon keys, e.g., movies, sports, or children's programming. The system can be adapted to present to the user only those programs meeting particular preference category when it is activated by the user. As with the Channel Preference icons, the microcontroller may display the icon corresponding to the activated preference category to remind the user of the currently activated mode of system operation.

The question mark icon **162** at the far right of the third horizontal bar in the menu of FIG. **16** identifies a program guide system "Help" mode in which information explaining the operation of the system is displayed for the user. Again, by manipulating the cursor using the appropriate keys on the remote controller, the user can select this mode. Once selected, the next submenu appearing in the Help mode asks the user to identify the particular portion of the system about which the user would like to view Help information.

The icons appearing in the last horizontal bar of the MENU mode identify certain interactive and/or other types of information services which the programming system, acting as a gateway, makes available to the user as shown in FIG. **17**. By manipulating the cursor, the user can select any one of the identified services, as shown in FIGS. **31-35**.

For example, if the user initially selects the "X\*PRESS" icon appearing in the last horizontal bar, he is presented with a submenu such as that shown in FIG. **31**. Using the direction arrow and enter keys on the remote controller, the user selects one of the three entries appearing in the display of FIG. **31**. Once a particular entry is selected, the electronic program guide connects the user to the selected service and passes control to the particular service application software, as shown in FIGS. **32-35**.

Additionally, the electronic program guide could be configured to store a unique digital identifier for each program along with its schedule information and later use the identifier—e.g., by transmitting it—to indicate to a recording or storage device, such as a video recorder, that the user wishes to record the program. The program guide could also use the identifier to automatically control operation of the video recorder. The electronic program guide could also be configured to use other stored schedule information for this purpose.

The form and content of a particular computer program to implement the invention disclosed herein will be readily apparent to those skilled in the art of video system programming and graphic display. A flow chart showing the operation logic of the system is shown in FIGS. **36A-D**. It will also be appreciated by those skilled in the art that there can be departure from the specific embodiment of the invention described herein without departing from the true scope of the claims appended hereto.

What is claimed is:

1. A method for allowing a user to browse program listings while viewing at least a substantial portion of a program on a display comprising:

- displaying a program in at least a substantial of a program in at least a portion of the display;
- displaying at least one interactive program listing on the display simultaneously with the at least a substantial portion of the program;
- allowing the user to select the at least one interactive program listing; and
- displaying a second program corresponding to the selected interactive program listing in at least a portion of the display, in response to receiving the selection from the user.

2. The method of claim 1, wherein the at least one interactive program listing comprises a program title and a program channel.

3. The method of claim 1, wherein the program is selected from the group consisting of a television program, a promotional video clip, a prerecorded program, a video on demand program, a near video on demand program, or a pay per view program.

4. The method of claim 1, wherein the user selects the at least one interactive program listing on a user control means.

5. The method of claim 1, wherein the program is displayed on a first portion of the display, the at least one interactive program listing is displayed on a second portion of the display, and said first portion is larger than said second portion.

6. The method of claim 1, wherein the program is displayed on a first portion of the display, the at least one interactive program listing is displayed on a second portion of the display, and the first portion is smaller than the second portion.

7. The method of claim 1, further comprising allowing the user to select a reminder message corresponding to a program to be viewed at a future date.

8. The method of claim 7, further comprising displaying the reminder message at a time prior to the future date.

9. The method of claim 8, wherein the time prior to the future date is determined by the user.

10. The method of claim 8, wherein the reminder message is displayed on the display simultaneously with the program.

11. A system for allowing a user to browse program listings while viewing at least a substantial portion of a program on a display comprising:

- means for displaying at least a substantial portion of a program in at least a portion of the display;
- means for displaying at least one interactive program listing on the display simultaneously with the at least a substantial portion of the program;
- means for allowing the user to select the at least one interactive program listing; and
- means for displaying a second program corresponding to the selected interactive program listing in at least a portion of the display, in response to receiving the selection from the user.

12. The system of claim 11, wherein the at least one interactive program listing comprises a program title and a program channel.

13. The system of claim 11, wherein the program is selected from the group consisting of a television program, a promotional video clip, a prerecorded program, a video on demand program, a near video on demand program, or a pay per view program.

14. The system of claim 11, wherein the user selects the at least one interactive program listing on a user control means.

15. The system of claim 11, wherein the program is displayed on a first portion of the display, the at least one interactive program listing is displayed on a second portion of the display, and said first portion is larger than said second portion.

16. The system of claim 11, wherein the program is displayed on a first portion of the display generator, the at least one interactive program listing is displayed on a second portion of the display, and the first portion is smaller than the second portion.

17. The system of claim 11, further comprising means for allowing the user to select a reminder message corresponding to a program to be viewed at a future date.

18. The system of claim 17, further comprising means for displaying the reminder message at a time prior to the future date.

19. The system of claim 18, wherein the time prior to the future date is determined by the user.

20. The system of claim 18, wherein the reminder message is displayed on the screen simultaneously with the program.

21. An interactive media guide comprising:

- a video display controller;
- a microprocessor programmed to:
  - direct the video display controller to display at least one interactive program listing on a display simultaneously with at least a substantial portion of a program;
  - allow a user to select the at least one interactive program listing; and
  - direct the video display controller to display a second program corresponding to the selected interactive program listing in at least a portion of the display, in response to receiving the selection from the user.

22. The media guide of claim 21, wherein the at least one interactive program listing comprises a program title and a program channel.

23. The media guide of claim 21, wherein the program is selected from the group consisting of a television program, a promotional video clip, a prerecorded program, a video on demand program, a near video on demand program, or a pay per view program.

24. The media guide of claim 21, wherein the user selects the at least one interactive program listing on a user control means.

25. The media guide of claim 21, wherein the program is displayed on a first portion of the display, the at least one interactive program listing is displayed on a second portion of the display, and said first portion is larger than said second portion.

26. The media guide of claim 21, wherein the program is displayed on a first portion of the display, the at least one interactive program listing is displayed on a second portion of the display, and the first portion is smaller than the second portion.

27. The apparatus of claim 21, wherein the microprocessor is further programmed to allow the user to select a reminder message corresponding to a program to be viewed at a future date.

28. The media guide of claim 27, wherein the microprocessor is further programmed to direct the video display controller to display the reminder message at a time prior to the future date.

29. The media guide of claim 28, wherein the time prior to the future date is determined by the user.

30. The media guide of claim 28, wherein the reminder message is displayed on the screen simultaneously with the program.

UNITED STATES PATENT AND TRADEMARK OFFICE  
**CERTIFICATE OF CORRECTION**

PATENT NO. : 7,100,185 B2  
APPLICATION NO. : 09/997659  
DATED : August 29, 2006  
INVENTOR(S) : Gerald E. Bennington et al.

Page 1 of 2

It is certified that error appears in the above-identified patent and that said Letters Patent is hereby corrected as shown below:

Title page, Item (56), under the title "References Cited", after "3,440,427", change

"Krammer" to read -- Kammer --;

Title Page Item (56) Page 3, first column, in "GB 87/00884" change "6/1986"

to read -- 6/1988 --;

second column, in "Lowenstein, R. L." change "Alter" to -- Aller --;

in "Judice" change "Come" to -- Cornes --;

Title Page Item (56) Page 4, first column, in "Schiender B.R." change to

"Schlender B.R.";

in "Antonofs" change "Science," to

-- Popular Science, --;

second column, in "42nd Annual" after "June 6-9" insert -- 1993 --.

Column 2, line 24, after "used" delete "is" (second occurrence);

line 29, change "objectional" to -- objectionable --.

Column 8, line 41, after "those" delete "s".

Column 11, line 26, change "utilizing" to -- Utilizing --.

Column 12, line 9, change "ill" to -- 111 --.

Column 13, line 22, after "system" delete "S";

line 37, change "Guides®" to -- Guide® --.

Column 14, line 12, change "them ode" to -- the mode --.

Column 15, line 20, delete "15".

Column 16, line 3, delete "is";

line 50, change "service-and" to -- service and --.

UNITED STATES PATENT AND TRADEMARK OFFICE  
**CERTIFICATE OF CORRECTION**

PATENT NO. : 7,100,185 B2  
APPLICATION NO. : 09/997659  
DATED : August 29, 2006  
INVENTOR(S) : Gerald E. Bennington et al.

Page 2 of 2

It is certified that error appears in the above-identified patent and that said Letters Patent is hereby corrected as shown below:

Column 19, line 66, change “**4BE** or **46C**” to -- **48B** or **48C** --.

Column 21, line 17, change “**61**” to -- **81** --.

Column 23, line 5, change “displaying a program in at least a substantial of a program”  
to -- displaying at least a substantial portion of a program --.

Signed and Sealed this

Tenth Day of July, 2007

A handwritten signature in black ink on a light gray dotted background. The signature reads "Jon W. Dudas" in a cursive style.

JON W. DUDAS

*Director of the United States Patent and Trademark Office*

UNITED STATES PATENT AND TRADEMARK OFFICE  
**CERTIFICATE OF CORRECTION**

PATENT NO. : 7,100,185 B2  
APPLICATION NO. : 09/997659  
DATED : August 26, 2006  
INVENTOR(S) : Bennington et al.

Page 1 of 1

It is certified that error appears in the above-identified patent and that said Letters Patent is hereby corrected as shown below:

Title Page, Item (56) References Cited:

Insert --4,991,011 A 2/1991 Johnson et al. 358/141--.

Signed and Sealed this

Thirty-first Day of July, 2007

A handwritten signature in black ink on a light gray dotted background. The signature reads "Jon W. Dudas" in a cursive style.

JON W. DUDAS  
*Director of the United States Patent and Trademark Office*

UNITED STATES PATENT AND TRADEMARK OFFICE  
**CERTIFICATE OF CORRECTION**

PATENT NO. : 7,100,185 B2  
APPLICATION NO. : 09/997659  
DATED : August 29, 2006  
INVENTOR(S) : Bennington et al.

Page 1 of 1

It is certified that error appears in the above-identified patent and that said Letters Patent is hereby corrected as shown below:

Title Page, Item (56) References Cited:

Insert --4,991,011 A 2/1991 Johnson et al. 358/141--.

This certificate supersedes Certificate of Correction issued July 31, 2007.

Signed and Sealed this

Twenty-first Day of August, 2007

A handwritten signature in black ink on a light gray dotted background. The signature reads "Jon W. Dudas" in a cursive style.

JON W. DUDAS  
*Director of the United States Patent and Trademark Office*