

# **EXHIBIT I**

**United States Patent**

[15] **3,660,861**

**Delmonico**

[45] **May 9, 1972**

[54] **COMBINATION ROUND TOWEL AND HOLDER**

[72] Inventor: **Edward N. Delmonico**, 1546 Bruce St., North Vancouver, British Columbia, Canada

[22] Filed: **Jan. 6, 1970**

[21] Appl. No.: **1,016**

[30] **Foreign Application Priority Data**

Jan. 10, 1969 Canada.....039,777

[52] U.S. Cl. ....15/209 R, 248/360

[51] Int. Cl. ....A47k 10/12

[58] Field of Search.....15/105, 208, 209 R; 248/359, 248/360; 211/16, 48

[56] **References Cited**

**UNITED STATES PATENTS**

2,299,950 10/1942 Gebhart.....15/208

2,204,947 6/1940 Apfelbaum.....15/208  
 2,307,752 1/1943 Anderson.....248/360 X  
 2,121,561 6/1938 English.....15/105 X  
 3,159,281 12/1964 Hutter.....211/16 X

*Primary Examiner*—William H. Schultz  
*Attorney*—Johnson, Marcus & Wray

[57] **ABSTRACT**

A functional and decorative towel and hanger assembly including a hanger with a first portion adapted to be secured to a wall and a second portion detachably connectable to a towel for suspending the same therefrom, and a circular towel connected to the latter at the approximate geometric center of the towel such that when draped, it provides a neat appearing decorative assembly functional for use in that a minimal amount of towel is utilized for anchoring the same with the remainder being usable for drying hands.

**4 Claims, 8 Drawing Figures**

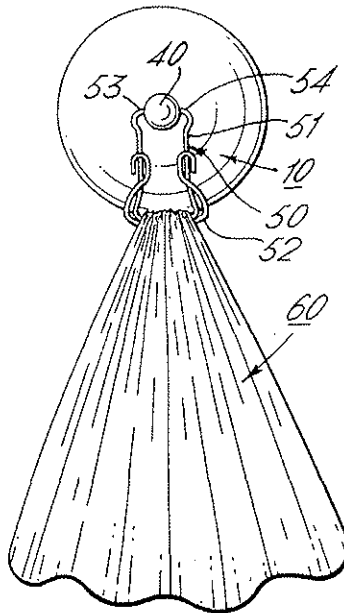

PATENTED MAY 9 1972

3,660,861

SHEET 1 OF 2

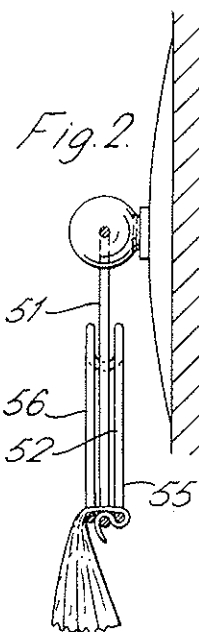
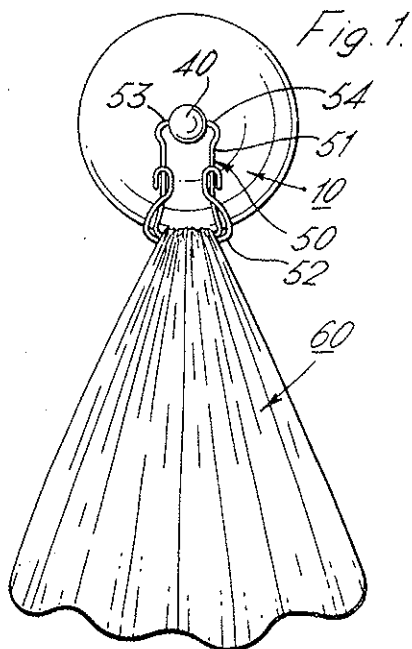

Fig. 3.

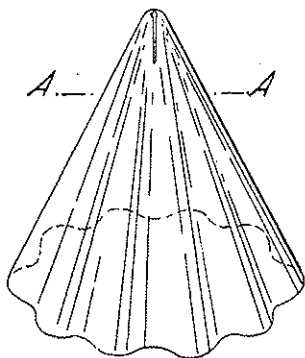
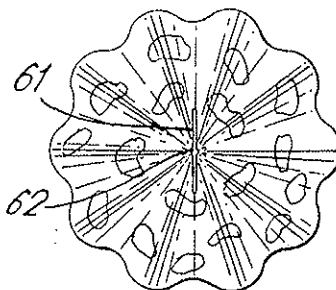

Fig. 4.



EDWIN L. DEBENWITZ  
INVENTOR

BY  
*[Signature]*  
AGENTS

PATENTED MAY 9 1972

3,660,861

SHEET 2 OF 2

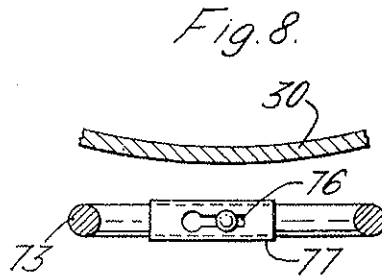
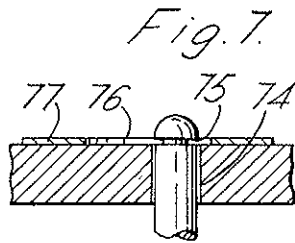
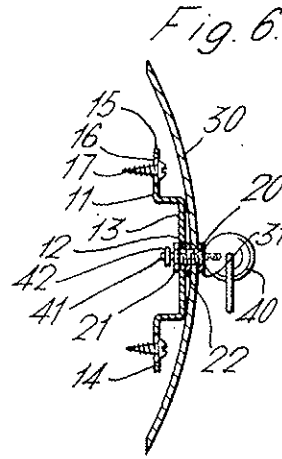
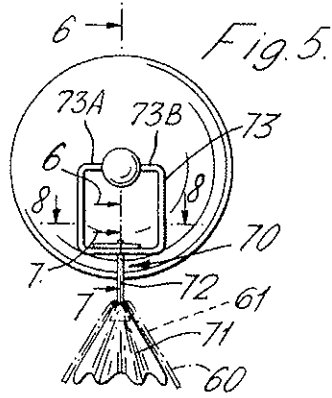

EDWARD N. HELMANSO  
INVENTOR

BY *Edmond J. J. J. J.*  
AGENTS

3,660,861

1

## COMBINATION ROUND TOWEL AND HOLDER

This invention relates to improvements in bathroom towels or the like absorbent material suspended from a wall for use in, for example, drying one's hands.

The existing towels for use in bathrooms, washrooms and the like are generally rectangular and are loosely hung on a hanger such that they may be readily removed for use. A basic disadvantage to this type of arrangement is that the towel is normally untidy from being hurriedly replaced. Also it is time-consuming for the individual to replace the towel each time it is used. A further disadvantage of the rectangular towel is that when suspended, a considerable area of contact is required so as not to bunch the towel tightly and thus permit it to dry during the intervals of non-use. A still further disadvantage of rectangular and square towels is than when suspended from a wall, if not precisely arranged, the rear face, which is often undecorated relative to the front face of the towel, is exposed and accordingly detracts from an otherwise neat and decoratively arranged room. Prior attempts have been made to suspend towels in such a manner that they are not removed for use and in such attempts, the towel has been mounted on a roller so that it may be readily moved from one location to another, providing maximum use. The feature of movement has been necessary because of the towel being suspended from an area of material which corresponds to any other portion on the towel, that is usable area.

A principal object of the present invention is to provide a towel which may be readily used while remaining anchored to a support.

A still further object of the present invention is to provide a towel which, when suspended from an anchor, is decorative, enhancing the appearance of the room.

A still further object of the present invention is to provide a towel which may be suspended from an area relatively small compared to the area of the towel which is usable in absorbing moisture in, for example, drying one's hands.

A still further object of the present invention is to provide a towel and suspension for same such that only one face of the material need be decorated without detracting from the appearance of the towel when suspended from a hanger on a support.

In accordance with the present invention, there is provided, in combination, a towel substantially circular in outline configuration detachably anchored to a support adjacent the towel's geometric center.

The invention is illustrated, by way of example in the accompanying drawings wherein:

FIG. 1 is a front elevational view of a circular towel suspended from a hanger;

FIG. 2 is a side, partial sectional, elevational view of the assembly illustrated in FIG. 1;

FIG. 3 is an oblique view of a circular towel diagrammatically illustrating the relative areas of the towel used to suspend the same and usable portion for drying one's hands;

FIG. 4 is a top plan view of a towel incorporating a modified version;

FIG. 5 is a front elevational view illustrating a modified means of detachably suspending a circular towel;

FIG. 6 is a detailed sectional view taken substantially along section 6—6 of FIG. 5;

FIG. 7 is a partial, sectional, elevational view taken along section 7—7 of FIG. 5; and

FIG. 8 is a view taken substantially along line 8—8 of FIG. 5.

Referring now in detail to the drawings, illustrated in FIG. 1 is the combination of a holder 10 and towel 60 detachably anchored to the holder and suspended therefrom. The towel 60 is circular in plan view and accordingly, drapes, as illustrated in FIG. 1, into a triangular-shaped configuration in vertical elevational view with the front half of the towel being in direct registry with the rear half of the towel such that only the outer surface of the towel is exposed. The towel is suspended from its geometric center and in this manner, a relatively

2

minor area of the towel is used to anchor the same to the hanger. Various means may be utilized to detachably secure the towel to the hanger as will be seen hereinafter.

The holder 10 (see FIG. 6) consists of a mounting bracket 11, a cover plate 30 and a clip 50. The mounting bracket 11 has a central aperture 12 in a portion 13 offset from the respective ones of a pair of opposed terminal end portions 14 and 15, each having a slot 16 therein for receiving a mounting screw 17. A threaded sleeve 20 passes through the aperture 12 in the bracket and is connected thereto by nuts 21 and 22 located one on each side of the bracket and which are threaded onto the sleeve. The cover plate 30 is circular in outline configuration, as seen in FIGS. 1 and 5 (convex outwardly as viewed in FIG. 6) and is attached to the sleeve 20 by a further lock nut 31. A spherical ball element 40 is rotatably mounted on the sleeve 20 by a rod 41 which is attached to the ball 40 and projects through the sleeve. The rod 41 may be threaded into the ball 40, it may be press-fit into a suitable recess in the ball or alternatively, may be welded thereto. Rod 41 is retained in the sleeve 20 by a C-lock member 42 or any other suitable assembly. The ball 40, accordingly, is pivotally mounted for rotation about a generally horizontal axis. The clip 50 consists of a U-shaped wire member 51 having a slider 52 mounted thereon. The clip 50 illustrated in FIG. 1 and 2 is the same as disclosed in U.S. Pat. No. 3,160,937 issued Dec. 15th, 1964 to C. A. Nickason and includes a pair of inwardly directed, terminal end portions 53 and 54, on the U-shaped member 51, projecting into respective ones of a pair of oppositely directed recesses in the ball element 40. It will be readily apparent from such mounting that the U-shaped member 51 is pivotally attached to the ball element 40 for movement about a horizontal axis substantially perpendicular to the previously mentioned pivotal mounting of the ball. The pivotal mountings, accordingly, allow the towel 60, as viewed in FIG. 1, to swing to the left and right and also to the left and right as viewed in FIG. 2. The slider element 52 may be of any type for detachably anchoring the towel to the U-shaped member 51 but preferably is of the type in the aforementioned patent. In reference to FIG. 2, the slider 52 includes respective ones of a pair of arcuate arms 55 and 56 located one on each side of the U-shaped wire member 51 and the towel is anchored by threading the same in a manner diagrammatically illustrated in FIG. 2. For further description of the construction and operation of the clip member 50, reference may be had to the aforementioned United States patent.

As previously mentioned, the towel 60 is circular in outline configuration as illustrated in FIG. 4 and because of this shape the inner surface of the towel does not become exposed when the towel is suspended from its geometric center. This permits having a towel which is decorative on one surface only without detracting from the appearance when suspended from a hanger in a washroom. The circular towel, accordingly, is a decorative item having a neat appearance. Further to providing something which is pleasing in appearance, the circular towel has the advantage of being able to be suspended from a minor area portion such that it can remain attached to a hanger leaving the major portion of the towel area for use in drying hands. This is diagrammatically illustrated in FIG. 3 wherein it will be readily apparent the area of towel above a plane A—A in FIG. 3 is minor compared to the area below. It is the area below which is usable when the towel is suspended from the hanger.

A modification to the circular towel is illustrated in FIG. 4 wherein a longitudinal slit 61 passes through the geometric center 62 of the towel and extends laterally therebeyond. The slit 61 is of such length that a person's head can readily pass through the same. The towel 60, accordingly, may be draped over the shoulders of a person rendering it useful for example when shaving or washing one's hair to protect one's wearing apparel.

The clip 50 previously described may be replaced by many different types of assemblies for detachably securing the towel 60 to a mounting bracket. A modified clip 70 is illustrated in

3,660,861

3

4

FIGS. 5 to 7 inclusive and consists of a member 71 having a shaft 72 extending therefrom detachably securable to a U-shaped member 73 connected to the previously described ball element 40. The ball 40 has a pair of recesses in respective ones of opposite faces into which project respective ones of lugs 73A and 73B located on the free terminal ends of the member 73. The shaft 72 may be connected, for example, by passing through an aperture 74 in the member 73 and have an undercut, grooved, end portion 75 receiving a narrow portion of a keyhole-type slot 76 in an element 77. The member 71 may be conical in shape having an undulating outer surface to facilitate draping the towel with neat folds when suspended therefrom. The element 71 is disposed on the inner surface of the towel and the shaft 72 projects through the towel for detachable securement to the U-shaped member 73. When a towel, as illustrated in FIGS. 3 and 4, is used, and which has a slit 61 passing through its geometric center, the shaft 72 passes through such slit, the latter obviously facilitating detachably connecting the towel to the hanger.

I claim:

1. In combination:

- a. a hanger including a first portion for anchoring the same to a support and a second portion detachably connectable to an article and including a conically shaped member with an undulating outer surface, said undulations being transverse to the longitudinal axis of said member, facilitating forming folds in a sheet of material suspended therefrom; and
  - b. a circular towel detachably connected to said second portion of said hanger.
2. The combination defined in claim 1 wherein said towel is connected to the hanger at the approximate geometric center of said towel.
3. The combination as defined in claim 1, wherein said second portion of said hanger is connected to said first portion by a swivel joint.
4. The combination as defined in claim 1, wherein said towel has a longitudinally extending slit at or adjacent its geometric center facilitating detachably connecting said towel to said hanger.

\* \* \* \* \*

25

30

35

40

45

50

55

60

65

70

75