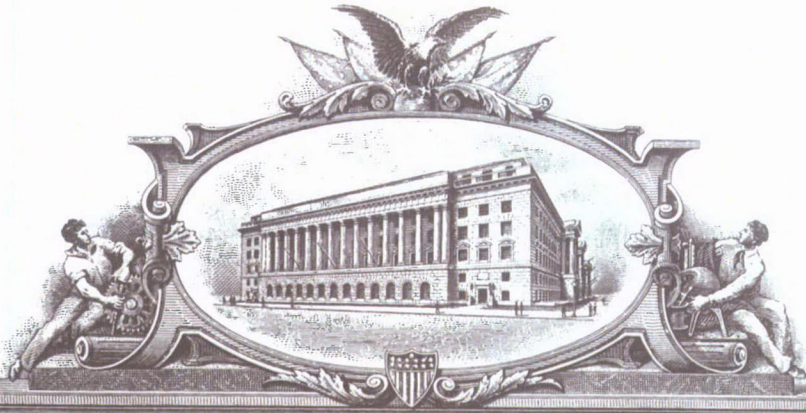

EXHIBIT E

U 7340046



THE UNITED STATES OF AMERICA

TO ALL TO WHOM THESE PRESENTS SHALL COME:

**UNITED STATES DEPARTMENT OF COMMERCE
United States Patent and Trademark Office**

February 07, 2012

**THIS IS TO CERTIFY THAT ANNEXED HERETO IS A TRUE COPY FROM
THE RECORDS OF THIS OFFICE OF:**

**U.S. PATENT: 7,934,148
ISSUE DATE: April 26, 2011**

**By Authority of the
Under Secretary of Commerce for Intellectual Property
and Director of the United States Patent and Trademark Office**



**M. K. CARTER
Certifying Officer**



US007934148B2

(12) **United States Patent**
Bobo, II

(10) **Patent No.:** **US 7,934,148 B2**
(45) **Date of Patent:** **Apr. 26, 2011**

(54) **SYSTEMS AND METHOD FOR STORING, DELIVERING, AND MANAGING MESSAGES**

(75) **Inventor:** **Charles R. Bobo, II, Atlanta, GA (US)**

(73) **Assignee:** **Advanced Messaging Technologies, Inc., Los Angeles, CA (US)**

(*) **Notice:** Subject to any disclaimer, the term of this patent is extended or adjusted under 35 U.S.C. 154(b) by 1090 days.

(21) **Appl. No.:** **11/609,003**

(22) **Filed:** **Dec. 11, 2006**

(65) **Prior Publication Data**
US 2007/0083614 A1 Apr. 12, 2007

Related U.S. Application Data

(63) Continuation of application No. 10/963,586, filed on Oct. 14, 2004, which is a continuation of application No. 10/436,798, filed on May 12, 2003, now Pat. No. 6,857,074, which is a continuation of application No. 09/840,759, filed on Apr. 23, 2001, now Pat. No. 6,564,321, which is a continuation of application No. 09/186,595, filed on Nov. 5, 1998, now Pat. No. 6,350,066, which is a continuation of application No. 08/944,741, filed on Oct. 6, 1997, now Pat. No. 5,870,549, which is a continuation-in-part of application No. 08/431,716, filed on Apr. 28, 1995, now Pat. No. 5,675,507.

(51) **Int. Cl.**
G06F 17/00 (2006.01)
H04M 1/658 (2006.01)
H04N 1/00 (2006.01)

(52) **U.S. Cl.** 715/208; 358/402; 358/403; 379/88.14; 379/88.15; 715/760

(58) **Field of Classification Search** 715/273, 715/760, 208; 358/402, 403; 379/88.14, 379/88.15
See application file for complete search history.

(56) **References Cited**

U.S. PATENT DOCUMENTS

4,106,060 A 8/1978 Chapman, Jr.
(Continued)

FOREIGN PATENT DOCUMENTS

AU 755321 12/2002
(Continued)

OTHER PUBLICATIONS

Kaashoek, M. Frans et al. "Dynamic Documents: Extensibility and Adaptability in the WWW", Sep. 15, 2004 Massachusetts Institute of Technology.*

(Continued)

Primary Examiner — Adam M Queler
Assistant Examiner — Tyler J Schallhorn

(74) *Attorney, Agent, or Firm* — Kenyon & Kenyon LLP

(57) **ABSTRACT**

Systems and methods are provided for storing a mark-up language file and delivering the file from a network server to a user's computer via a packet switched data network using a hyper-text transfer protocol (HTTP). The mark-up language file is stored in a storage area accessible by the network server, wherein the file contains information personal to the user. A notification is transmitted to the user's computer, wherein the notification serves to notify the user of the availability of the file. In response to a user request made in response to the notification, the mark-up language file is transmitted from the network server to the user's computer, via the packet switched data network, using the HTTP.

178 Claims, 18 Drawing Sheets

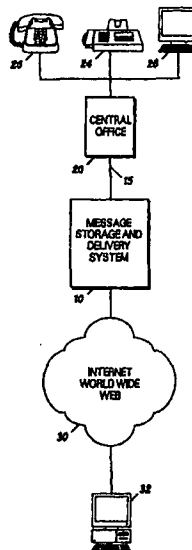

U.S. PATENT DOCUMENTS

4,130,885 A	12/1978	Dennis	
4,289,930 A	9/1981	Connolly et al.	
4,405,829 A	9/1983	Rivest et al.	
4,532,588 A	7/1985	Foster	
4,571,699 A	2/1986	Herzog	
4,713,780 A	12/1987	Schultz et al.	
4,754,428 A	6/1988	Schultz et al.	
4,816,653 A	3/1989	Anderl et al.	
4,837,798 A	6/1989	Cohen et al.	
4,853,961 A	8/1989	Pastor	
4,918,722 A	4/1990	Duehren et al.	
4,941,170 A	7/1990	Herbst	
5,008,814 A	4/1991	Mathur	
5,018,191 A	5/1991	Catron et al.	
5,029,199 A	7/1991	Jones et al.	
5,033,079 A	7/1991	Catron et al.	
5,047,918 A	9/1991	Schwartz et al.	
5,054,096 A	10/1991	Beizer	
5,065,427 A	11/1991	Godbole	
5,068,797 A	11/1991	Sansone et al.	
5,068,888 A	11/1991	Scherk et al.	
5,091,790 A	2/1992	Silverberg	
5,105,184 A	4/1992	Pirani et al.	
5,113,430 A	5/1992	Richardson, Jr. et al.	
5,113,496 A	5/1992	McCalley et al.	
5,115,326 A *	5/1992	Burgess et al.	358/440
5,127,003 A	6/1992	Doll, Jr. et al.	
5,129,080 A	7/1992	Smith	
5,167,011 A	11/1992	Priest	
5,175,762 A	12/1992	Kochis et al.	
5,193,110 A	3/1993	Jones et al.	
5,195,085 A	3/1993	Bertsch et al.	
5,210,824 A	5/1993	Putz et al.	
5,224,156 A	6/1993	Fuller et al.	
5,227,893 A	7/1993	Ett	
5,241,594 A	8/1993	Kung	
5,247,591 A	9/1993	Baran	
5,247,661 A	9/1993	Hager et al.	
5,255,312 A	10/1993	Koshiishi	
5,257,112 A	10/1993	Okada	
5,267,047 A	11/1993	Argenta et al.	
5,267,301 A	11/1993	Nishii	
5,274,635 A	12/1993	Rahman et al.	
5,276,869 A	1/1994	Forrest et al.	
5,283,887 A	2/1994	Zachery	
5,289,371 A	2/1994	Abel et al.	
5,289,472 A	2/1994	Cho	
5,291,302 A	3/1994	Gordon et al.	
5,291,546 A	3/1994	Giler et al.	
5,293,250 A	3/1994	Okumura et al.	
5,296,934 A	3/1994	Ohtsuki	
5,297,208 A	3/1994	Schlaflay et al.	
5,299,255 A	3/1994	Iwaki et al.	
5,301,226 A	4/1994	Olson et al.	
5,307,456 A	4/1994	MacKay	
5,313,572 A *	5/1994	Yamamoto et al.	358/403
5,317,628 A	5/1994	Misholi et al.	
5,333,266 A	7/1994	Boaz	
5,339,156 A	8/1994	Ishii	
5,349,636 A	9/1994	Iribarren	
5,351,276 A	9/1994	Doll, Jr. et al.	
5,355,472 A	10/1994	Lewis	
5,367,621 A	11/1994	Cohen et al.	
5,371,885 A	12/1994	Letwin	
5,379,374 A	1/1995	Ishizaki et al.	
5,384,830 A *	1/1995	Ide	379/88.24
5,384,835 A	1/1995	Wheeler et al.	
5,394,460 A	2/1995	Olson et al.	
5,394,522 A	2/1995	Sanchez-Frank et al.	
5,404,231 A	4/1995	Bloomfield	
5,406,557 A *	4/1995	Baudoin	370/407
5,418,908 A	5/1995	Keller et al.	
5,424,724 A	6/1995	Williams et al.	
5,432,841 A	7/1995	Rimer	
5,438,433 A	8/1995	Reifman et al.	
5,448,626 A	9/1995	Kajiya	
5,452,289 A	9/1995	Sharma et al.	
5,459,584 A	10/1995	Gordon et al.	
5,471,617 A	11/1995	Farrand et al.	
5,475,738 A	12/1995	Penzias	
5,479,408 A *	12/1995	Will	370/313
5,479,411 A	12/1995	Klein	
5,479,491 A	12/1995	Herrero Garcia et al.	
5,483,466 A	1/1996	Kawahara et al.	
5,483,524 A	1/1996	Lev et al.	
5,483,580 A	1/1996	Brandman et al.	
5,487,100 A	1/1996	Kane	
5,488,651 A	1/1996	Giler	
5,495,610 A	2/1996	Shing et al.	
5,497,373 A	3/1996	Hullen et al.	
5,502,637 A	3/1996	Beaulieu et al.	
5,509,123 A	4/1996	Dobbins et al.	
5,513,126 A	4/1996	Harkins et al.	
5,513,323 A	4/1996	Williams et al.	
5,517,556 A	5/1996	Pounds	
5,524,137 A	6/1996	Rhee	
5,526,353 A	6/1996	Henley et al.	
5,530,740 A *	6/1996	Iribarren et al.	379/88.17
5,530,852 A	6/1996	Meske, Jr. et al.	
5,534,913 A	7/1996	Majeti et al.	
5,537,415 A	7/1996	Miller et al.	
5,544,320 A	8/1996	Konrad	
5,546,388 A	8/1996	Lin	
5,548,789 A	8/1996	Nakanura	
5,552,901 A	9/1996	Kikuchi	
5,555,100 A	9/1996	Bloomfield et al.	
5,557,659 A *	9/1996	Hyde-Thomson	379/88.13
5,559,611 A *	9/1996	Bloomfield et al.	358/407
5,559,721 A	9/1996	Ishii	
5,561,703 A	10/1996	Arledge et al.	
5,568,536 A	10/1996	Tiller et al.	
5,568,540 A *	10/1996	Greco et al.	379/88.25
5,572,643 A	11/1996	Judson	
5,579,472 A	11/1996	Keyworth, II et al.	
5,590,178 A	12/1996	Murakami et al.	
5,604,737 A	2/1997	Iwami et al.	
5,604,788 A	2/1997	Tett	
5,608,446 A	3/1997	Carr et al.	
5,608,786 A	3/1997	Gordon	
5,608,874 A	3/1997	Ogawa et al.	
5,619,648 A	4/1997	Canale et al.	
5,621,727 A	4/1997	Vaudreuil	
5,625,675 A	4/1997	Katsumaru et al.	
5,630,060 A	5/1997	Tang et al.	
5,630,061 A	5/1997	Richter et al.	
5,633,916 A	5/1997	Goldhagen et al.	
5,634,005 A	5/1997	Matsuo	
5,647,002 A	7/1997	Brunson	
5,654,886 A	8/1997	Zereski et al.	
5,654,957 A	8/1997	Koyama	
5,657,461 A *	8/1997	Harkins et al.	715/733
5,664,102 A	9/1997	Faynberg	
5,673,316 A	9/1997	Auerbach et al.	
5,675,507 A	10/1997	Bobo, II	
5,677,955 A	10/1997	Doggett et al.	
5,687,220 A	11/1997	Finnigan	
5,689,550 A	11/1997	Garson et al.	
5,692,039 A	11/1997	Brankley et al.	
5,694,458 A	12/1997	Okada et al.	
5,694,546 A	12/1997	Reisman	
5,710,883 A	1/1998	Hong et al.	
5,712,901 A	1/1998	Meermans	
5,712,903 A	1/1998	Bartholomew et al.	
5,712,907 A	1/1998	Wegner et al.	
5,715,314 A	2/1998	Payne et al.	
5,715,444 A	2/1998	Danish et al.	
5,715,453 A	2/1998	Stewart	
5,717,742 A	2/1998	Hyde-Thomson	
5,724,406 A	3/1998	Juster	
5,724,410 A	3/1998	Parvulescu et al.	
5,724,424 A	3/1998	Gifford	
5,724,425 A	3/1998	Chang et al.	
5,724,514 A	3/1998	Arias	
5,724,567 A	3/1998	Rose et al.	
5,727,156 A	3/1998	Herr-Hoyman et al.	
5,732,219 A	3/1998	Blumer et al.	
5,737,395 A	4/1998	Iribarren	

US 7,934,148 B2

5,737,396 A	4/1998	Garcia	6,020,980 A	2/2000	Freeman
5,737,533 A	4/1998	de Hond	6,023,345 A	2/2000	Bloomfield
5,740,231 A	4/1998	Cohn et al.	6,023,700 A	2/2000	Owens et al.
5,742,596 A	4/1998	Baratz et al.	6,025,931 A	2/2000	Bloomfield
5,742,668 A	4/1998	Pepe et al.	6,028,679 A	2/2000	Murphy
5,742,905 A *	4/1998	Pepe et al. 455/461	6,032,192 A	2/2000	Wegner et al.
5,751,791 A	5/1998	Chen et al.	6,035,332 A	3/2000	Ingrassia, Jr. et al.
5,751,814 A	5/1998	Kafri	6,052,367 A	4/2000	Bowater et al.
5,751,956 A	5/1998	Kirsch	6,052,442 A	4/2000	Cooper et al.
5,754,939 A *	5/1998	Herz et al. 455/3.04	6,055,530 A	4/2000	Sato
5,758,088 A	5/1998	Bezaire et al.	6,061,448 A	5/2000	Smith et al.
5,761,201 A	6/1998	Vaudreuil	6,064,653 A	5/2000	Farris
5,761,396 A	6/1998	Austin et al.	6,064,723 A	5/2000	Cohn et al.
5,761,662 A	6/1998	Dasan	6,069,890 A	5/2000	White et al.
5,765,033 A	6/1998	Miloslavsky	6,072,862 A	6/2000	Srinivasan
5,768,528 A	6/1998	Stumm	6,073,165 A	6/2000	Narasimhan et al.
5,771,354 A	6/1998	Crawford	6,084,892 A	7/2000	Benash et al.
5,774,668 A	6/1998	Choquier et al.	6,084,952 A	7/2000	Beerman, Jr. et al.
5,781,614 A	7/1998	Brunson	6,085,101 A	7/2000	Jain et al.
5,781,901 A	7/1998	Kuzma	6,097,797 A	8/2000	Oseto
5,787,175 A	7/1998	Carter	6,108,329 A	8/2000	Oyama et al.
5,790,790 A	8/1998	Smith et al.	6,157,706 A	12/2000	Rachelson
5,790,793 A	8/1998	Higley	6,167,253 A	12/2000	Farris et al.
5,793,972 A	8/1998	Shane	6,181,781 B1	1/2001	Porter et al.
5,801,702 A	9/1998	Dolan et al.	6,185,603 B1	2/2001	Henderson et al.
5,805,298 A	9/1998	Ho et al.	6,192,407 B1	2/2001	Smith et al.
5,812,278 A	9/1998	Toyoda et al.	6,208,638 B1	3/2001	Rieley et al.
5,812,639 A	9/1998	Bartholomew et al.	6,211,972 B1	4/2001	Okutomi et al.
5,812,786 A	9/1998	Seazholtz et al.	6,212,550 B1	4/2001	Segur
5,819,092 A	10/1998	Ferguson	6,215,858 B1	4/2001	Bartholomew et al.
5,819,295 A	10/1998	Nakagawa et al.	6,216,173 B1	4/2001	Jones et al.
5,825,865 A	10/1998	Oberlander et al.	6,229,844 B1	5/2001	Kong
5,838,906 A	11/1998	Doyle et al.	6,233,318 B1	5/2001	Picard et al.
5,845,303 A	12/1998	Templeman	6,240,445 B1	5/2001	Kumar et al.
5,848,413 A	12/1998	Wolff	6,240,454 B1	5/2001	Nepustil
5,854,893 A	12/1998	Ludwig et al.	6,246,983 B1	6/2001	Zou et al.
5,855,015 A	12/1998	Shoham	6,256,115 B1	7/2001	Adler et al.
5,859,967 A	1/1999	Kaufeld et al.	6,259,533 B1	7/2001	Toyoda et al.
5,870,454 A	2/1999	Dahlen	6,263,064 B1	7/2001	O'Neal et al.
5,870,549 A	2/1999	Bobo, II	6,266,160 B1	7/2001	Saito et al.
5,870,552 A	2/1999	Dozier et al.	6,278,532 B1	8/2001	Heimendinger et al.
5,872,845 A	2/1999	Feder	6,282,270 B1	8/2001	Porter
5,872,926 A	2/1999	Levac et al.	6,285,777 B2	9/2001	Kanevsky et al.
5,881,233 A	3/1999	Toyoda et al.	6,288,799 B1	9/2001	Sekiguchi
5,892,591 A	4/1999	Anglin, Jr. et al.	6,295,350 B1	9/2001	Schreyer et al.
5,892,909 A	4/1999	Grasso	6,295,552 B1	9/2001	Shibata
5,893,908 A	4/1999	Cullen et al.	6,301,245 B1	10/2001	Luzeski et al.
5,903,723 A	5/1999	Beck et al.	6,301,339 B1	10/2001	Staples et al.
5,907,598 A	5/1999	Mandalia et al.	6,304,636 B1	10/2001	Goldberg et al.
5,911,776 A	6/1999	Guck	6,314,425 B1	11/2001	Serbini et al.
5,917,615 A	6/1999	Reifman et al.	6,330,070 B1	12/2001	Toyoda et al.
5,930,493 A	7/1999	Ottessen et al.	6,330,079 B1	12/2001	Dugan et al.
5,933,412 A	8/1999	Choudhury et al.	6,330,323 B1	12/2001	Gottlieb et al.
5,933,490 A	8/1999	White et al.	6,334,142 B1	12/2001	Newton et al.
5,937,041 A	8/1999	Cardillo, IV et al.	6,339,591 B1	1/2002	Migimatsu
5,937,161 A	8/1999	Mulligan	6,339,780 B1 *	1/2002	Shell et al. 715/207
5,937,162 A	8/1999	Funk	6,341,160 B2	1/2002	Tverskoy et al.
5,940,476 A	8/1999	Morganstein et al.	6,350,066 B1	2/2002	Bobo, II
5,940,598 A	8/1999	Strauss et al.	6,356,356 B1	3/2002	Miller, Jr. et al.
5,944,786 A	8/1999	Quinn	6,359,881 B1	3/2002	Gerszberg et al.
5,945,989 A	8/1999	Freishtat et al.	6,360,256 B1	3/2002	Lim
5,946,386 A	8/1999	Rogers et al.	6,404,513 B1	6/2002	Denker
5,958,016 A	9/1999	Chang et al.	6,411,696 B1	6/2002	Iverson et al.
5,960,085 A	9/1999	de la Huerga	6,417,930 B2	7/2002	Mori
5,961,582 A	10/1999	Gaines	6,430,272 B1	8/2002	Maruyama et al.
5,963,618 A	10/1999	Porter	6,486,895 B1 *	11/2002	Robertson et al. 715/776
5,963,892 A	10/1999	Tanaka et al.	6,498,835 B1	12/2002	Skladman et al.
5,970,490 A	10/1999	Morgenstern	6,510,438 B2	1/2003	Hasegawa
5,978,813 A	11/1999	Foltz et al.	6,564,321 B2	5/2003	Bobo, II
5,987,504 A	11/1999	Toga	6,597,688 B2	7/2003	Narasimhan et al.
5,987,508 A	11/1999	Agraharam et al.	6,643,034 B1	11/2003	Gordon
5,991,292 A	11/1999	Focsaneanu et al.	6,690,480 B2	2/2004	Maeda
5,996,006 A	11/1999	Speicher	6,742,022 B1	5/2004	King et al.
5,999,525 A	12/1999	Krishnaswamy et al.	6,775,264 B1	8/2004	Kurganov
5,999,594 A	12/1999	Mizoguchi et al.	6,795,108 B2	9/2004	Jarboe et al.
5,999,965 A	12/1999	Kelly	6,825,955 B1	11/2004	Shibata
6,009,173 A	12/1999	Sumner	6,948,070 B1	9/2005	Ginter et al.
6,009,469 A	12/1999	Mattaway et al.	2001/0014910 A1	8/2001	Bobo, II
6,014,668 A	1/2000	Tabata et al.			

2003/0208688 A1 11/2003 Bobo, II
 2005/0050349 A1 3/2005 Bobo, II
 2008/0229182 A1 9/2008 Hendricks et al.

FOREIGN PATENT DOCUMENTS

DE 4309072 A1 9/1994
 EP 0615368 A2 9/1994
 EP 0760503 A1 5/1997
 EP 0835021 A1 4/1998
 EP 0554456 A1 8/1998
 GB 2024561 A 1/1980
 GB 2157117 A 10/1985
 JP 2237338 A 9/1990
 JP 04018844 A 1/1992
 JP 04111557 A 4/1992
 JP 04150351 A 5/1992
 JP 04256273 A 9/1992
 JP 4265040 A 9/1992
 JP 04290033 A 10/1992
 JP 04291858 A 10/1992
 JP 05233488 A 9/1993
 JP 05235997 A 9/1993
 JP 05244292 A 9/1993
 JP 05284326 A 10/1993
 JP 05316309 A 11/1993
 JP 06069956 A 3/1994
 JP 06164645 A 6/1994
 JP 06217069 A 8/1994
 JP 07023057 A 1/1995
 JP 07038689 A 2/1995
 JP 07058845 A 3/1995
 JP 07212393 A 8/1995
 JP 07250094 A 9/1995
 JP 07288543 A 10/1995
 JP 07288668 A 1/1996
 JP 08009092 A 1/1996
 JP 08111692 A 4/1996
 JP 08130601 A 5/1996
 JP 08237294 A 9/1996
 JP 08237297 A 9/1996
 JP 08256235 A 10/1996
 JP 08286991 A 11/1996
 JP 08336053 A 12/1996
 JP 09023273 A 1/1997
 JP 07170288 A 2/1997
 JP 09046369 A 2/1997
 JP 09102798 A 4/1997
 JP 09135266 A 5/1997
 JP 09163064 A 6/1997
 JP 09200251 A 7/1997
 JP 09-223004 A 8/1997
 JP 09214559 A 8/1997
 JP 09214560 A 8/1997
 WO 94/06230 3/1994
 WO 95/01040 1/1995
 WO 95/06386 3/1995
 WO 95/20288 7/1995
 WO 9531060 A1 11/1995
 WO 9627160 A1 9/1996
 WO 9627967 A1 9/1996
 WO 9629663 A1 9/1996
 WO 9629664 A1 9/1996
 WO 96/34341 A1 10/1996
 WO 9638987 A1 12/1996
 WO 9641463 12/1996
 WO 97/09682 3/1997
 WO 9710668 3/1997
 WO 9718635 A2 5/1997
 WO 9723082 A1 6/1997
 WO 9723988 A1 7/1997
 WO 9817041 A2 4/1998
 WO 9823058 A2 5/1998

OTHER PUBLICATIONS

Liu, Cricket et al. "Managing Internet Information Services", Dec. 1994 O'Reilly and Associates.*
 Kaashoek, M. Frans "Dynamic Documents: Wireless Access to the WWW" 1994, IEEE.*

McFetridge, Craig "The Server Side Includes Tutorial" Feb. 19, 1995.*
 Lotus Fax Server Gives cc:Mail, Notes Users better fax gateway services, Jan. 30, 1995, v. 17, n. 5, 1995 WLNR 5462216, InfoWord Media Group, Inc. (2 pgs).
 Lotus Notes for Dummies, IDG Books Worldwide, Inc., 1994, p. 295, (3 pgs).
 M. Horton, Standard for Interchange of USENET Messages, RFC 850 (Jun. 1983) (19 pgs).
 M. Kauffman, Computer Based Fax Processing The Kauffman Group, Cherry Hill, N.J. First edition 1994, pp. 19-20, 61, 75, 77-79 (ISBN 0-936648-62-7) (10 pgs).
 Mail2HTML.c, Convert Mail/News Files to HTML (Prototype), Jan. 21, 1993, Rev. 0.3 (17 pgs).
 Marc Andreessen, NCSA Mosaic for X 2.0 available, www.talk.newsgroup message, Nov. 10, 1993 (8 pgs).
 Mark Miller, Defusing TCPIP-based internet problems in layers, Network World, Oct. 17, 1994 (6 pgs).
 MHonArc: Index Page Customization, v1.0.0, <http://ftp.sunet.se/pub/text-processing/sgml/DTD2HTML/> file MHonArc 1.0.0.tar.gz. (5 pgs).
 Michael L. Nelson, et al., Electronic Document Distribution Design of the Anonymous FTP Langley Technical Report Server, NASA Technical Memorandum 4567, Mar. 1994, National Aeronautics and Space Administration, Langley Research Center, Hampton, Virginia (20 pgs).
 Michael L. Nelson, et al., The Widest Practicable Dissemination: The NASA Technical Report Server, Computers in Aerospace 10 (Mar. 28-30, 1995, San Antonio, TX), 1995, American Institute of Aeronautics and Astronautics, Inc. (14 pgs).
 Michael L. Nelson, et al., The World Wide Web and Technology Transfer at NASA Langley Research Center, Proceedings of the Second International World Wide Web Conference: Mosaic and the Web (Oct. 19-21, 1994, Chicago, IL, pp. 701-710), NASA Langley Research Center (12 pgs).
 Michael L. Nelson, et al., World Wide Web Implementation of the Langley Technical Report Server, Sep. 5, 1994, NASA Technical Memorandum 109162, National Aeronautics and Space Administration, Langley Research Center, Hampton, Virginia (31 pgs).
 NCSA http—Unified Directory Structure (1 pg).
 NCSA httpd—Compatibility (1 pg).
 NCSA httpd—Document Root Directive.html (1 pg).
 NCSA httpd—Security (1 pg).
 NetScan Kofax: The Easy Way to Share a Scanner, 1996, KOFAX, <http://www.netscan.kofax.com>. (10 pgs).
 On the Road: The Telephone User Interface, Computer Telephony Expo in Dallas, TX, Mar. 7, 1995, Applied Voice Technology, Inc. (4 pgs).
 Pacific Bell Information Services, 1994 Annual Report, p. 6 (1994) (10 pgs).
 Putting Paper Documents In The World-wide Web, Myka, 1994 Article (10 pgs).
 QNet Business Plan, Apr. 1987 (104 pgs).
 R. Thomas, Hands-On Wizard's Grabbag Getting a Bang Out of Unix, UnixWorld's Open Computing, vol. 11, No. 1 (Jan. 1, 1994) (5 pgs).
 Reg Quinton, Sendmail—Care and Feeding, Mar. 24, 1992, pp. 1-44, Computing and Communications Services, The University of Western, Ontario, Canada (23 pgs).
 RightFAX Web Client. (RightFAX's RightFAX Web Client) (Product Announcement) Software Magazine, Apr. 1, 1997 (1 pg).
 Ronald J. Vetter, et al., Mosaic and the World-Wide Web, pp. 49-57, Computer Practives, Oct. 1994 (9 pgs).
 S. Broadhead, Getting Your Fax Straight: Getting Ahead of the Game with Fax Server Technology Network Computing, Feb. 1997 (Abstract) (2 pgs).
 S. Leffler, FlexFAX—A Network-based Facsimile Service, Silicon Graphics, Inc., Nov. 27, 1990 (9 pgs).
 S.C. Hui, et al., A Distributed Fax Messaging System, Proc. of IEEE Singapore Intl. Conf. on Networks/Intl Conf on Information Engineering 1995, pp. 393-397, IEEE Cat. No. 95TH8061 (6 pgs).

- S.D. Reilly, et al., Increasing the Computational Potential of the World Wide Web, Feb. 9, 1996, pp. 1-28, Dept. of Computer Science School of Engineering and Applied Science University of Virginia, Charlottesville, VA (30 pgs).
- Stephen Lauder milk, Trio Set to Roll Out Fax Gear for LANs, PC Week, Aug. 17, 1992, pp. 39, 47.
- Steve Putz, Design and Implementation of the System 33 Document Service, ISTL-NLTT-93-07-01, 1993, Xerox Corporation (116 pgs).
- Steve Putz, Interactive Information Services Using World-Wide Web Hypertext, First International Conference on World-Wide Web, (May 25-27, 1994), Apr. 20, 1994, pp. 1-10, ISTL-QCA-1994-03-01, Xerox Corporation (10 pgs).
- Steve Putz, System 33 Gateway Code, Gateway Software, <http://www.w3.org/Gateways/System33/gateway> (14 pgs).
- Stuart Melnitsky, Fax Server Face Off, Network World, Apr. 15, 1996, pp. 43-45.
- T. Kasper, Untangling the Web—The role of text retrieval in a hypertext environment (6 pgs).
- The Geometry Forum News Gateway—A Newsreader for the World Wide Web, Forum Outposts: The Geometry Forum Newsletter (Dec. 30, 1994) (2 pgs).
- V. Kumar, et al., A SHARed Web to Support Design Teams, Enterprise Integration Technologies Corp., 1994 IEEE, 0-8186-5705-7/94, pp. 178-182.
- Wayne Rash, The Fax of the Matter, Information Week, May 20, 1996 (4 pgs).
- XDOC Data Format, Technical Specification, Mar. 1995, pp. 1:1-2:10, vol. 3.0, The Document Company Xerox (15 pgs).
- Yahoo, Inc., NetScan Kofax, Yahoo! Internet Life, Jan. 1997, p. 73, vol. 3, No. 1, <<http://www.yil.com/>>.
- Yvonne L. Lee, Vendors to Showcase Integrated Telephony Solutions, InfoWorld, Mar. 4, 1996, p. 18(1), vol. 18, No. 10, Gale Group (1 pg).
- European Search Report in European Patent Application No. EP 09165919, Sep. 1, 2009 (59 pgs).
- Notice of Reason for Rejection, Dispatch Date: Jan. 17, 2008, Patent Application No. JP 2000-515377 (5 pgs).
- Invalidity Contentions of Defendant Packetel, Inc. in *j2 Global Communications, Inc. v. Packetel, Inc.*, Case No. 09cv3240 DDP (AJWx) (20 pgs).
- Invalidity Contentions of Defendant Protus IP Solutions, Inc. in *j2 Global Communications, Inc. v. Protus IP Solutions, Inc.*, Case No. 05cv5610 DDP (AJWx) (109 pgs).
- Invalidity Contentions of Defendant Venali, Inc. in *j2 Global Communications, Inc. v. Venali, Inc.*, Case No. 04v1172 DDP (AJWx) (52 pgs).
- Defendant Captaris, Inc.'s Invalidation Contentions in *j2 Global Communications, Inc. v. Captaris, Inc.*, Case No. 09cv4150 DDP (AJWx) (217 pgs) (2 Parts).
- Defendant Easylink Service International Corporation's Invalidation Contentions as to '638 in *j2 Global Communications Inc. v. Easylink Service International Corporation*, Case No. 09cv4189 DDP (AJWx) (17 pgs).
- Defendant Easylink Service International Corporation's Invalidation Contentions as to '688 & '132 in *j2 Global Communications, Inc. v. Easylink Service International Corporation*, Case No. 09cv4189 DDP (AJWx) (92 pgs).
- Defendant EasyLink's Opening Claim Construction Brief in *j2 Global Communications v. Easylink Services Intl. Corp.*, 09cv4189 (55 pgs).
- Defendant Venali's Opening Claim Construction Brief in *j2 Global Communications, Inc. v. Venali, Inc.*, cv 04-1172 DDP AJWx.pdf (filed Jun. 11, 2010) (42 pgs).
- Plaintiff *j2 Global Communications, Inc.*'s Opening Markman Brief filed on Jun. 11, 2010, *j2 Global Comm., Inc. v. Venali, Inc.*, Case No. 04-1172 DDP (AJWx) (DI 160) (65 pgs).
- Consolidated Opening Claim Construction Brief of Defendants Captaris, Inc., Packetel, Inc. and Protus IP Solutions filed in *j2 Global Communications, Inc. v. Protus, et al.*, filed Jun. 11, 2010, *j2 Global Communications v. Protus 05cv5610* (61 pgs).
- Reply Claim Construction Brief of Defendants Captaris, Inc., Packetel, Inc. and Protus IP Solutions filed Jul. 1, 2010 *j2 Global Comm v. Protus 05cv5610* (52 pgs).
- Defendant Venali's Reply Claim Construction Brief, filed Jul. 1, 2010 *j2 Global v. Venali 04cv1172* (43 pgs).
- Plaintiffs Reply Markman Brief filed on Jul. 1, 2010, *j2 Global Comm., Inc. v. Protus IP Solutions, Inc.*, Case No. 05-5610 DDP (AJWx) (67 pgs).
- Easylink's Reply to Plaintiff's Claim Construction Brief filed Jul. 1, 2010 09cv4189 (46 pgs).
- j2 Global Communications, Inc. v. Callwave, Inc.* CV04-7068 DDP AJWx Callwave Inc.'s Responses to Plaintiff's First Set of Interrogatories Dec. 22, 2004 (12 pgs).
- j2 Global Communications, Inc. v. Venali, Inc.*, cv 04-1172 DDP AJWx, Defendant Venali, Inc.'s Objections and Responses to Plaintiff *j2 Global Communications, Inc.*'s First Set of Interrogatories (Nos. 1-7) (19 pgs).
- Notice of Dismissal filed on Sep. 22, 2005, *j2 Global Comm., Inc. v. Mijanda, Inc.*, Case No. 05-5300 DDP (AJWx) (DI 15) (1 pg).
- Declaration of Professor Walter Scacchi Regarding Defendant CallWave, Inc.'s Opening Claim Construction Brief in *j2 Global Communications, inc. v. Call Wave, Inc.*, CV 04-7068 VBKx (20 pgs).
- Defendant Protus' Answer and Counterclaim in *j2 Global Comm. v. Protus 05cv5610* filed Nov. 12, 2005 (12 pgs).
- Administrators Guide Lotus Notes Release 3, Lotus Development Co., 1993, p. 5-54 (1 pg).
- Alta Vista Search, SHAREWARE.COM: Search results, Dec. 5, 1996 (2 pgs).
- Andrew Eberle, The Path Taken: Inbound Routing, Network World, May 2, 1994, p. 101.
- (Author Unknown) Call and Voice Processing PC Board Roundup (Buyers Guide), in Teleconnect Library, Inc., Dec. 1995, v13, n12, pp. 1-6.
- B. Kantor, et al., Network News Transfer Protocol, A Proposed Standard for the Stream-Based Transmission of News, RFC 977, Feb. 1986 (29 pgs).
- B. Mathers, et al., Lotus Notes Internet Cookbook, last modified Apr. 21, 1995, (25 pgs).
- C. Hunt, TCP/IP Network Administration, Jan. 1994(268 pgs).
- Carlos A. Varela, et al., Providing Data on the Web: From Examples to Programs, Second International WWW Conference, Oct. 17-21, 1994, pp. 1-12, <http://fiaker.ncsa.uiuc.edu:8080/WWW94-2/paper.html>.
- Chane Fullmer, et al., A TCP/IP Network Facsimile System Built from Publicly Available Software, in Association for Computing Machinery (ACM), 1992, ref. No. 089791-472-4/92/0002/525, pp. 525-529.
- comp.mail.mine meta-FAQ: Help for MIME problems, downloaded from the Internet at www.cis.ohio-state.edu/text/faq/usenet/mail/mimefaq/part/faq.html. Aug. 8, 1997 (8 pgs).
- Dale Dougherty, et al., The Mosaic Handbook for Microsoft Windows, Oct. 1994, O'Reilly & Associates (239 pgs).
- Duval & Main, Exploring the Internet with Mosaic, Library Software Review, vol. 13, No. 4, Winter 1994, Sage Periodicals Press, pp. 269-279.
- ED Liebowitz, The Dialogic VAR Parade: Open Voice Processing for Art Dealers, the Blind, the Dallas Cowboys and the RBOCs, in Teleconnect, Apr. 1993, v11, n4, p. 40(3) (2 pgs).
- e-mail-fax-120.hqx, E-Mail Fax Search Results, Shareware.com, Nov. 24, 1996, <<http://www.search.shareware.com/code/mail+fax+&category=All-Categories>> (2 pgs).
- F. Sung and M. Johnson, Faxing Docs in HP MPower, Apr. 1994 Hewlett-Packard Journal, pp. 53-61.
- Facsimile and Voice System Links Offices, Electronics, Jan. 18, 1979 (379-100), S9054 0063, pp. 69-70.
- FaxMail Networks for Windows v5.13: Fax over a network, ZD NET Software Library, Nov. 14, 1996, <http://search2zdnet.com/cgi-bin/texis/swlib/hotfiles/search.html>. (3 pgs).
- FaxSav, faxMAILER—How FaxMailer Works, (1996) (2 pgs).
- FaxSav, The FaxSav Technology Edge: A White Paper, (1997) (5 pgs).
- French, Fox, Maly & Selman, Wide Area Technical Report Service—Technical Reports Online, Communications on the ACM, Apr. 1995, ACM 002-0782/95/0400 pp. 124-127.

- Graphics, Visualization and Usability Center GSQL-ORACLE Backend, Date Unknown (2 pgs).
GSQL in detail, Dec. 1993 (4 pgs).
- Halama, James R., et al., An Interactive Electronic Bulletin Board Implementation for Mosaic and HTTP Server, EBBSMos.htm, Date Unknown (4 pgs).
- Helen Plotkin, The Forum Newsreader Plans, Apr. 5, 1994, <http://mathforum.org/kb/plaintext.jspa?messageID=1072645> (2 pgs).
- Hong, J., et al.; Personal Electronic Notebook with Sharing, Center for Design Research, Stanford University, 1080-1383/95, 1995 IEEE, pp. 88-94.
- J. Kent, Browsing Electronic Mail: Experiences interfacing a Mail System to a DBMS. Proceedings of the Fourteenth International Conference on Very Large Data Base. Los Angeles, CA. pp. 112-123, 1988.
- Jay C. Weber, The Webmaster's Starter Kit, WWW Fall '94 paper, Enterprise Integration Technologies Corporation (4 pgs).
- Jennifer Myers, Announcing Version 0.11 of 'readcomics', a Common Gateway Interface World Wide Web Gateway to clari.feature.dilbert, January 17, 1994, v. 0.11, Article 9857, comp.lang.perl. (6 pgs).
- Jennifer Myers, readcomics, Jan. y 18, 1994, v. 0.12 (4 pgs).
- JFAX Personal Telecom, Free Downloads JFAX Communicator Software1, Dec. 4, 1996 <<http://www.jfax.net/software.htm/>> (2 pgs).
- JFAX Personal Telecom, Get All Your Voice-Mail and Faxes in your E-Mail, Dec. 4, 1996, <<http://www.jfax.net/>> (4 pgs).
- JFAX Personal Telecom, What the Media Says About JFAX Personal Telecom, Oct. 31, 1996, <<http://www.fax.net/>> (2 pgs).
- K. Tomaru, Electronic Mail Systems, Japan Annual Review in Electronics, Computers & Telecommunications, 1983, vol. 9, Telecommunication Technology, pp. 283-290.
- Kevin Bachus, Touring Lotus Notes: The New World of Group ware, Windows Magazine, Mar. 1, 1994 Issue 503, CMP Publications, Inc., Factiva, Inc. (7 pgs).
- Kevin Brown, et al., Mastering Lotus Notes, Sybex, Inc., 1995, p. 939.
- L. Orozco-Barbosa, et al., Design and Performance Evaluation of Intelligent Multimedia Services, rec'd Jun. 28, 1996, pp. 219-232, v. 20 (1997), Computer Communications.
- Request for Ex Parte Reexamination Transmittal Form Control No. 90007539.
- Request for Reexamination Control No. 90007539 Detailed Statement in Support of Request for Reexamination of United States Patent No. 6,350,066.
- European Patent Office—Letter of the opponent dated Sep. 30, 2010 in Application No. 98950859.3-2413 / 1034651.
- Schreier, Ulf et al., "Alert: An Architecture for Transforming a Passive DBMS into an Active DBMS", Proceedings of the 17th International Conference on Very Large Data Bases, Sep. 1991, pp. 468-478, Barcelona, Spain.
- Bowman, Judith S. et al., "The Practical SQL Handbook: Using Structure Query Language, Third Edition", pp. 44, 310-312, Addison-Wesley Developers Press, Reading, MA.
- Goldberg, David et al., Using Collaborative Filtering to Weave an Information Tapestry, Communications of the ACM Archive, Dec. 1992, pp. 61-70, vol. 35, No. 12, ACM (The Association for Computing Machinery), New York, NY.
- Terry, Douglas et al., "Continuous Queries over Append-Only Databases". Proceedings of the 1992 ACM SIGMOC International Conference on Management of Data, pp. 321-330, 1992.
- j2 Global Communications, Inc. v Venali, Inc.*, cv 04-1172 DDP AJWx, Defendant Venali, Inc.'s Objections and Responses to Plaintiff *j2 Global Communications, Inc.'s* First Set of Interrogatories (Nos. 1-7) (19 pgs).
- j2 Global Communications, Inc. v Venali, Inc.*, cv 04-1172 DDP AJWx, litigation cover page (1 pg).
- Kennie Jones, NASA Langley Research Center, Tops On-Line—Automating the Construction and Maintenance of HTML Pages, 1994 (7 pgs).
- "Invalidity Contentions of Defendant Protus IP Solutions, Inc." in *j2 Global Communications, Inc. v. Protus IP Solutions, Inc.*, Case No. 6:08-cv-211-LED-JDL.
- "Defendant Captaris, Inc.'s, Local Patent Rule 3-3 Invalidity Contentions" in *j2 Global Communications, Inc. v. Captaris, Inc.*, Case No. 6:08-cv-262 (LED).
- "Defendant Easylink Service International Corporation's Invalidity Contentions under P.R. 3-3" in *j2 Global Communications, Inc. v. Easylink Service International Copration*, Case No. 6:08-cv-263.
- Deixler, Lyle; Fax Forges Ahead; Teleconnect; v. 14 n 11, p. 25(12). Fax Solutions; Lan Times, v.13 n 21, p. 123(5).
- Guide to Intelligent Least Cost Routing, Right Fax, Inc.
- Guide to Internet Faxing, Right Fax, Inc.
- Hertzoff, Ira; AT&T Global Messaging , The AT&T EasyLink Services Sourcebook; Ch. 6, p. 107-47.
- Mendel, Brett; Net Faxing Awaits Its Day; Lan Times, Dec. 9, 1996, v13 n 27 p. 25(2).
- Beware the Fax Beast, Network World Reprint; vol. 12, # 48.
- Rightfax Introduces New Fax Server Designed for the Enterprise; Rightfax News Release.
- Rightfax Poised for Internet Faxing; Rightfax News Release.
- Rightfax Ships Internet Connectivity Module for Lan Fax Software; Rightfax News Release;
- Guo Zhen Sheng, et al., "Internet-Based Mail Fax Gateway Technology", 1997 IEEE International Conference on Intelligent Processing Systems, Oct. 28-31, Beijing, China 97TH8335 vol. 2 of 2 pp. 1607-1611.
- Savetz, Kevin; Faxing From the Internet; Tricks of the Internet Gurus, CH. 6. pp. 165-174.
- RightFAX E-mail Gateway Guide, 1996.
- Castelle FaxPress Internet Faxing White Paper, Dec. 9, 1997.
- Castelle FaxPress End User Features, Dec. 9, 1997.
- Castelle FaxPress The Integrated Network Fax Server, Dec. 9, 1997.
- Castelle FaxPress Network Diagram, Dec. 16, 1997.
- Castelle FaxPress Lotus cc-Mail Gateway, Dec. 9, 1997.
- Castelle FaxPress Lotus Notes Gateway, Dec. 9, 1997.
- Castelle FaxPress Exchange Direct, Dec. 9, 1997.
- Castelle Infopress Press Release: New Castelle System Merges Web, Fax, E-Mail and Phone for Universal Document Access/Delivery, Oct. 28, 1996.
- FAXSAV, Rebiller/Reseller Manual, 1997.
- FAXSAV Launches Serverlink 1997.
- Simeonov, P.L., A Distributed Intelligent Network Approach to Bridge Switching . . . , Computer Comms. & Networks, 1997.
- Hoffmann, P., Integrating Telephony and Internet, IEEE Conference on Protocols for Multimedia Systems . . . 1997.
- Tanenbum, A.S., Computer Networks, 3rd Edition, 1996.
- Boran.com, It Security Cookbook-Firewalls.
- Cormen, T.H., Introduction to Algorithms, 8th Printing, 1992.
- Patterson, D.A., Computer Organization & Design: The Hardware/Software Interface, 2nd, 1998.
- Malamud, C, RFC 1528 Priciples of Operation for the TPC.INT Subdomain: Remote Printing-Technical Procedures, Oct. 1993 ("Malamud 1").
- Malamud, C, RFC 1530 Priciples of Operation for the TPC.INT Subdomain: Remote Printing-Technical Procedures, Oct. 1993 ("Malamud 2").
- Rose, M.T., The Internet Message: Closing the Book with Electronic Mail, 1993.
- Toyoda, K., RFC 2305 A Simple Mode of Facsimile Using Internet Mail, Mar. 1998.
- Berners-Lee, T., Hypertext Transfer Protocols—HTTP/1.0 Network Working Group Internet Draft, Dec. 1994.
- Luotonen, A., CERN httpd Reference Manual: A Guide to A World-Wide Web Hyper Text Daemon, May 1994.
- December, J., The World Wide Web Unleashed, 1994.
- Microsoft Corporation, Microsoft Internet Information Server Technical Articles Web Services Frequently Asked Questions, 1997.
- RightFax Installation & Administration Guide, Version 3.5 1994.
- RightFax Installation & Administration Guide, Version 3.51 1994.
- RightFax Installation & Administration Guide, Version 3.0 1993.
- RightFax User's Guide, V. 3.5 1994.
- RightFax E-mail Gateway Guide 1996.
- RightFax Web Client Installation and Administration Guide, Version 1.1 1997.
- An Introduction to Database Systems vol. II, Chapters 7 & 8.

- The DCA/Intel Communicating Applications Specification. InstantCom/ESL.
- Delrina WinFax Pro 4.0 User's Guide.
- Delrina WinFax Pro 4.1 Set-Up Guide.
- Delrina WinFax Pro 4.1 for Networks User's Guide.
- FaxBack InForms Reference Guide.
- CallXpress3 Unified Messaging To Be Fully Compatible with Windows 95 and Microsoft Mail Server.
- Applied Voice Technology Announces New Version of its Award-Winning Voice and Call Processing System CallXpress3.
- Applied Voice Technology Announces CallXpress3 Release 4.0.
- Low Cost Messaging the LAN Fax Way (McCusker).
- Surprise! Fax Servers Smarten Up (Levine).
- Pursuing One Peripheral (Blankenhorn).
- What's Ahead for PC/Fax (Cook).
- Meet the Intranet.
- Now Your PC Can "Read" Your Fax (Stevens).
- Intel NET SatisFaction Software User's Guide.
- Intel FAXability Plus Software for Windows User's Guide.
- Intel Net SatisFaction Software Installation Guide for Net Ware networks.
- FaxPress Supervisor's Guide.
- Commerce Path Messaging Connector.
- VinFax Pro's User Guide v. 3.0.
- RightFax E-mail Gateway Guide 3.51.
- Commerce Path Net Link User Guide.
- WinFax Pro for Networks 4.1 Marketing Brochure.
- "Defendant Comodo Communications, Inc.'s Local Patent Rule 3-3 Invalidity Contentions" in *j2 Global Communications, Inc. v. Comodo Communications, Inc.*, Case No. 6:08-cv-275.
- Coresoft Technologies, CenterPoint Fax Server Administration Guide, 1997-1998.
- Russell Kahan, "Fax over IP" Gale Group, Inc., 1997.
- Shung-Foo Yu et al., "A multimedia gateway for phone/fax and MIME mail" 20 Computer Communications, pp. 615-627, Aug. 1997.
- Ahmed Patel, et al., "A technique for multi-network access to multimedia messages" 20 Computer Communications 324-337, Jul. 1997.
- Daniel J. Rosenbaum, "The E-Mail Route to Fax" 7 PC World, pp. 168-170, Jun. 1989.
- Hertzoff, Ira; AT&T Global Messaging, The AT&T EasyLink Services Sourcebook; Ch. 7, p. 149-176.
- Hertzoff, Ira; AT&T Global Messaging, The AT&T EasyLink Services Sourcebook; Ch. 10, p. 219-249.
- Hertzoff, Ira; AT&T Global Messaging, The AT&T EasyLink Services Sourcebook; Ch. 11, p. 251-283.
- Hertzoff, Ira; AT&T Global Messaging, The AT&T EasyLink Services Sourcebook; Ch. 12, p. 285-319.
- RightFax Installation & Administration Guide, 1996.
- RightFax E-mail Gateway Guide, 1994, v. 3.51.
- RightFax Users Guide, 1996.
- J. Duffy, "IBM's SAA Gets Voice: Company to Expand Enterprise Networking Horizons," Computer Systems News, p. 1, May 14, 1990.
- E Spire, "Fax->E-mail" Google Groups, <http://groups-beta.google.com/group/comp/acom.telecom>, Dec. 20, 1995.
- Plaintiff's Opposition Claim Construction Brief in *j2 Global Communications, Inc. v Venali, Inc.*, cv 04-1172 DDP AJWx.
- Brief in Opposition to Plaintiff j2's Opening Claim Construction Brief in *j2 Global Communications, Inc. v Venali, Inc.*, cv 04-1172 DDP AJWx.
- Plaintiff's Opening Claim Construction Brief in *j2 Global Communications, Inc. v Venali, Inc.*, cv 04-1172 DDP AJWx.
- Opening Claim Construction Brief in *j2 Global Communications, Inc. v Venali, Inc.*, cv 04-1172 DDP AJWx.
- Docket Report from cv 04-1172 DDP AJWx.
- Critical Path Data Sheet—Critical Path Messaging Server, 2 pages, Dec. 2002r.
- Critical Path Data Sheet—Critical Path Internet File Server, 2 pages, Dec. 2002r.
- Critical Path Data Sheet—Critical Path Presentation Server, 2 pages, Dec. 2002r.
- Critical Path Data Sheet—Critical Path SMS Access Server, 2 pages, 2002r.
- Critical Path Data Sheet—Critical Path Calendar Server, 2 pages, Dec. 2002r.
- Critical Path Data Sheet—Critical Path Personal Address Book Server, 2 pages, Dec. 2002r.
- CPT™ Meta-Directory Server, 4 pages, Jun. 2002r.
- Critical Path Meta-Directory Server, 1 page, May 8, 2003 <http://www.cp.net/solutions/metaDirectoryServer.html>.
- Tumbleweed Communications, 3 pages, May 8, 2003 http://www.tumbleweed.com/en/products/ime_overview.html.
- Tumbleweed Communications, 1 page, May 8, 2003 http://www.tumbleweed.com/en/products/ime_product_architecture.html.
- Tumbleweed Communications, 1 page, May 8, 2003 http://www.tumbleweed.com/en/products/ime_for_automated_deliveries.html.
- Tumbleweed Communications, 3 pages, May 8, 2003 [_http://www.tumbleweed.com/dy/print/](http://www.tumbleweed.com/dy/print/).
- Tumbleweed Communications, 1 page, May 8, 2003 http://www.tumbleweed.com/en/products/ime_portal_integration.html.
- Tumbleweed Communications, 1 page, May 8, 2003 http://www.tumbleweed.com/en/products/ime_message_tracking.html.
- Tumbleweed Communications, 2 pages, May 8, 2003 <http://www.tumbleweed.com/dy/print/>.
- Nakagawa, et al., Development of a Network Model for the Total Health Care Management of Multi-Vendor Environment, in Multimedia Communications, 1994, Multimedia '94, 5th IEEE COMSOC Int'l Workshop, pp. 5/2/1-5/2/4 (workshop occurred May 16-19, 1994).
- Larry M. Edwards, E-Mail: Industry is Posting Impressive Gains, in San Diego Business Journal, pp. 1 and 17-18 (Mar. 7, 1994).
- Aurthor unknown, Lotus Executive Details Notes' Work Flow Strategy; Pinches Notes as a platform for Third-Party Products, in Network World, p. 27 (Sep. 6, 1993).
- Paul Kinnucan, What's New in the Fax World, in Systems Integration, vol. 23, No. 2 at 50 (Feb. 1990).
- Author unknown, Delrina WinFax Pro 4.0 Focuses on Ease of Use, Newsbytes, Post-Newsweek Business Information, Inc., (Mar. 15, 1994).
- David Morgenstern, DynaWeb Server Holds SGML Books: Web Server Queries, Converts to HTML, in MacWeek, vol. 8, No. 28 at 12 (Jul. 11, 1994).
- Gord Nickerson, WorldWideWeb: hypertext from CERN, Computers in Libraries, vol. 12, No. 11, p. 75 (1992).
- Mario J. Silva and Randy H. Katz, The case for Design Using the World Wide Web, in 32nd ACM/EEE Design Automation Conference (1995).
- Barry Fenn and Hermann Maurer, Harmony on an Expanding Net, ACM Interactions, pp. 27-38 (Oct. 1994).
- "JFax Personal Telecom—Plug a Phone Into Your E-Mail," downloaded from the Internet at www.jfax.com on Oct. 31, 1996.
- J. Peck, et al., "MH & xmh, Email for USOIS & Programers," O'Reilly & Associates, Inc., Sebastopol, Ca, 1995.
- "ScanFX-Scanning Hardware for Internet E-Mail", Aug. 1990.
- "Defendant CallWave's Supplemental Disclosures Pursuant FRCP 26(A)(1)" in *j2 Global Communications, Inc. v. CallWave, Inc.*, CV04-7068 DDP AJWx.
- MIME (Multipurpose Internet Mail Extension) Part One: "Mechanisms for Specifying and Describing the Format of Internet Message Bodies", Internet RFC 1341 and 1521, Sep. 1993.
- MIME (Multipurpose Internet Mail Extension) Part Two: "Message Header Extensions got Non-ASCII Text", Internet RFC 1342, Sep. 1993.
- Patel, Henderson and Georganas, The Multimedia Fax-MIME Gateway, IEEE Multimedia, 1994.
- "Hypertext Markup Language (HTML), A Representation of Textual Information and Meta Information for Retrieval and Interchange," Draft version, Jun. 1993.
- "Lotus Turns up the Heat on Microsoft Exchange Rival," Network Week, Jan. 27, 1995.
- "Novell Inc. to Demonstrate Alex, a Universal In-box That Will Accept and Store Email, Voice mail and Faxes," Computer Reseller News, Feb. 6, 1995.

- Public-Key Cryptography Standards (PKCS), Revised Nov. 1, 1993, downloaded from the Internet at www.ftp.rsa.com, on Oct. 1, 1998.
- j2 Global Communications, Inc. v. Venali, Inc.* CV04-1172 DDP AJWx Venali, Inc.'s Answer to First Amended Complaint for Patent Infringement and Counterclaim for Declaration of Noninfringement and Invalidity Nov. 1, 2004.
- j2 Global Communications, Inc. v. CallWave, Inc.*, CV04-7068 DDP AJWx Callwave Inc.'s Second Set of Supplemental Responses to Plaintiff's First Set of Interrogatories Mar. 30, 2005.
- M. Sirbu, "RFC1049—Content-type header field for Internet messages", [Online], Mar. 1988, XP-002542400 retrieved from the Internet: URL: <http://www.fags.org/rfcs/rfc1049.html>, [retrieved on Aug. 21, 2009].
- Luca Manunza, "SOFT>WebMail, a www interface to e-mail" [Online], Mar. 10, 1995, XP-002542401 retrieved from the Internet: URL: <http://scout.wisc.edu/Projects/PastProjects/NH/95-03-/95-3-20/0010.html>, [retrieved on Aug. 20, 2009].
- Luca Manunza, SOFT>WebMail, a www interface to e-mail—1st public release [Online], Mar. 30, 1995, XP-002542402 retrieved from the Internet: URL: <http://scout.wisc.edu/Projects/PastProjects/NH/95-03/95-03-30/0009.html>, [retrieved on Aug. 20, 2009].
- Craig McFetridge, "Server Side Includes" [Online], Feb. 19, 1995, XP-002542447 retrieved from the Internet: URL: <http://http-server.carleton.ca/~dmcfet/html/ssi.html>, [retrieved on Aug. 21, 2009].
- Daniel W. Conolly, "Towards closure on HTML" [Online], Apr. 7, 1994, XP-002542403 retrieved from the Internet: URL: <http://www.w3.org/MarkUp/html-spec/html-direction.html>, [retrieved on Aug. 20, 2009].
- Jason Levitt, "A Push-Button Solution" [Online], Apr. 3, 1995, XP-002542404 retrieved from the Internet: URL: <http://www.informationweek.com/521/21olj.htm?jsessionid=LN00SMQTD0F01QE1GHPSKH4ATMY32JVN>, [retrieved on Aug. 21, 2009].
- "Plaintiff's Opening Markman Brief" in *j2 Global Communications, Inc. v. CallWave, Inc.*, CA 04-7068 DDP AJWx.
- "Plaintiff's Opposition Markman Brief" in *j2 Global Communications, Inc. v. CallWave, Inc.*, CA 04-7068 DDP AJWx.
- "Defendant CallWave, Inc.'s Opening Claim Construction Brief" in *j2 Global Communications, Inc. v. CallWave, Inc.*, CA 04-7068 DDP AJWx.
- "Defendant CallWave, Inc.'s Opposition to Plaintiff j2's Opening Markman Brief" in *j2 Global Communications, Inc. v. CallWave, Inc.*, CA 04-7068 DDP AJWx.
- "Defendant CallWave's Supplemental Disclosures Pursuant FRCP 26(A)(1)" in *j2 Global Communications, Inc. v. CallWave, Inc.*, CA 04-7068 DDP AJWx.
- Delrina Advertisement, 1994.
- "Working with . . . Fax Mailbox" PCToday by Jim Cope (Sep. 1994, vol. 8, Issue 9).
- Voice/Fax Combos by Stuart Warren, Computer Telephony, Sep./Oct. 1994, p. 88.
- B.S. Kaliski Jr., "An Overview of the PKCS Standards," RSA Laboratories Technical Note, RSA Security, Inc., Public-Key Cryptography Standards (PKCS), Revised Nov. 1, 1993.
- "Keys and Certificates" downloaded from the Internet at www.elock.com.
- "Cryptography Systems," downloaded from the internet at www.elock.com.
- How does the S/MIME encryption and digital signature process work? downloaded from the Internet at www.worldtalk.com, on Jul. 25, 1999.
- PKCS #7: Cryptographic Message Syntax Standard, RSA Laboratories Technical Note, Version 1.5, RSA Security, Inc. Public-Key Cryptography Standards (PKCS), Revised Nov. 1, 1993, downloaded from the Internet at www.ftp.rsa.com, on Oct. 1, 1998.
- C. Ellison, et al., "Default Protecting Secret Keys with Personal Entropy," Mar. 3, 1999.
- Chaffing and Winnowing: Confidentiality without Encryption, downloaded from the Internet at www.theory.lcs.mit.edu, on Jul. 13, 1999.
- "S/MIME Or OpenPGP? How Will You Secure Your E-mail?" downloaded from the Internet at www.worldtalk.com.
- "S/MIME Frequently Asked Questions," downloaded from the Internet at www.rsa.com, on Jul. 23, 1999.
- "S/MIME Frequently Asked Questions," downloaded from the Internet at www.rsa.com, on Nov. 16, 1999.
- "SDML-Signed Document Markup Language," W3C Note Jun. 19, 1998, downloaded from the Internet at www.w3.org, on Oct. 28, 1998.
- C. R. Baudoin, "The Sematech Electronic Mail System," Proceedings of the Digital Equipment Computer Users Society, pp. 221-231, U.S.A., Spring 1989".
- N. Borenstein, et al., "A Multi-media Message System for Andrew," USENIX Winter Conference, Dallas, TX, pp. 37-42, Feb. 9-12, 1988.
- J. Donahue, et al., "Walnut: Storing Electronic Mail in a Database," XEROX PARK, CSL-85-9, Nov. 1985.
- K. Hofrichter, et al., "The BERKOM Multimedia-Mail Teleservice," Proceedings of the Fourth Workshop on Future Trends of Distributed Computing Systems, Lisbon, Portugal, pp. 23-30, Sep. 22-24, 1993.
- J. K. Reichard, "Leveraging E-Mail," PC Magazine: 241, 244 and 245 (May 1995), et al., "Browsing Electronic Mail: Experiences Interfacing a Mail System to a DBMS," Proceedings of the Fourteenth International Conference on Very Large Data Bases, Los Angeles, CA, pp. 112-123, 1988.
- E. Moeller, et al., "The BERKOM multimedia-mail teleservice," Computer Communications, vol. 18:2, pp. 89-102, Feb. 1995.
- J. Pan, "Internet Security & Firewall Issues for NIIIP Virtual Enterprise," NIIIP OMB Meeting, Boca Raton, FL, Jan. 23-25, 1996.
- A. Poggio, et al., "CCWS: A Computer-Based, Multimedia Information System," Multimedia Communications, pp. 92-103, Oct. 1985.
- A. Reinhardt, "Smarter E-Mail Is Coming," BYTE Magazine, pp. 90-108, Mar. 1993.
- J. Rosenberg, et al., "An Overview of the Andrew Message System," Computer Communications Review, vol. 17:5, pp. 99-108, Apr. 1988.
- S. Sakata, et al., "A Distributed Interoffice Mail System," Multimedia Communications, pp. 106-116, Oct. 1985.
- S. J. Vaughan-Nichols, "Internet Publishing Tools Proliferate," BYTE Magazine, Mar. 1995.
- "Microsoft Messaging Application Pro Interface (MAPi)," downloaded from the Internet at www.microsoft.com/win32dev/apiext/mapiwp.html.
- Novell Announces *Softsolutions* 4.1, PR Newswire, New Orleans, LA, May 9, 1995.
- "How Posta Works", downloaded from the Internet at www.tumbleweed.com/posta/posta_overview.html.
- "Overview of the Trans-Virtual Enterpriser Server," Product Overview.
- V. Gay, et al., "Conception of a Multimedia Electronic Mail Based on Standards," Proceedings of the Fourth Workshop on Future Trends of Distributed Computing Systems, Sep. 22-24, 1993".
- J. Postel, et al. "An Experimental Multimedia Mail System," ACM Transactions on Office Information Systems, vol. 6, No. 1, Jan. 1988".
- "Web Mail", Information Week, pp. 120, Dec. 16, 1996.
- "Ipswitch Delivers the First Internet-Ready Messaging Server for Windows NT That Allows Access to E-mail via the Web", PR Newswire, pp. 1209NEM007, Dec. 9, 1996.
- "Hotmail Introduces Hotmail WebCourier Direct Content Delivery Service", Business Wire, pp. 02030123, Mar. 1997.
- J. B. Postel, RFC0821, Simple Mail Transfer Protocol, HTTP://rfc-koeln.de/html, 80 pages, Aug. 1982.
- M. Sherman, et al., "Allocation of User-Interface Resources in the Andrew Toolkit," International Conference on Multimedia Information stems, pp. 261-272, 1991".
- M. Sherman, et al., "Building Hypertext on a Multimedia Toolkit: An Overview of Andrew Toolkit Hypermedia Facilities," Proceedings of the First European Conference on Hypertext, pp. 13-24, France, Nov. 1990.
- V. S. Wheatman, "Sorting Through the Secure Messaging Maze," Messaging Magazine, downloaded from the Internet at www.ema.org/html/pubs/mmv4n2/msgmaze.htm, Mar.-Apr. 1998".
- The Andrew Messages System, downloaded from the Internet at www.cs.cmu.edu/afs/cs.cmu.edu/project/atk-ftp/web/ams.html.
- "Facts on File re: Andrew," downloaded from the internet at www.cs.cmu.edu:80/afs/cs.cmu.edu/project/atk-ftp/web/faxonfile.html.
- Welcome to the Andrew Consortium, www.cs.cmu.edu:80/afs/cs.cmu.edu/project/atk-ftp/web/andrew-home.html.

- "The Andrew Publication Archive," <ftp.andrew.cmu.edu/pub/AUIS/PAPERS/REDME>.
- "Bibliography of Publications on the Andrew User Interface System," <ftp.andrew.cmu.edu/pub/AUIS/PAPERS/BIBLIOGRAPHY> on May 13, 2002.
- J. Peek, et al., "MH & xmh, Email for Users & Programmers," O'Reilly & Associates, Inc., Sebastopol, CA, 1995.
- B. Costales, et al., "sendmail," O'Reilly & Associates, Inc., Sebastopol, CA, 1993.
- K. S. Morris, "A Technical Overview of MIME," Web Developer's Journal Archives, Mar. 1995.
- "comp.mail.mime FAQ (frequently asked questions list)," downloaded from the Internet at www.cis.ohio-state.edu/text/faq/usenet/mail/mime-faq/part/faq.html Jun. 11, 1997.
- "Composing and Sending MIME Message," downloaded from the Internet at www.gieldasgarage.com/mh/cosemine.htm.
- "Reading MIME Messages," downloaded from the Internet at www.gieldasgarage.com/mh/cosemime.htm.
- "comp.mail.mime frequently asked questions list (FAQ) (1/3)," downloaded from the Internet at www.tu-chemnitz.del-fri/mime/FAQ-1.htmk, Sep. 4, 1994.
- M. Grand, "MIME Overview," downloaded from the Internet at www.mindspring.com/~mgrand/mime.html, revised Oct. 26, 1993.
- D. W. Connolly, "A Formalism for Internet Information References," downloaded from the Internet at www.w3.org/people/Connolly/drafts/formalism.txt.
- G. Vaudreuil, "The Multipart/Report Content Type for the Reporting of Mail System Administrative Messages," Network Working Group, Internet Draft, Sep. 1995.
- G. Vaudreuil, "Enhanced Mail System Status Codes," Network Working Group, Internet Draft, Jun. 1995.
- K. Moore, et al., "An Extensible Message Format for Delivery Status Notifications," Network Working Group, Internet Draft, Sep. 1995.
- "Information Technology—Text and office systems—Distributed-office-applications model-Part 1: General model," International Standard ISO / IEC 10031-1:1-73, 1991 (E).
- "Information Technology—Text and Office Systems—Distributed Office Applications Model: Part 2; Distinguished-object-reference and Associated Procedures," International Standard ISO/IEC 10031-2:1-13, 1991.
- D. H. Crocker, "Standard for the Format of ARPA Internet Text Message," RFC 822, 1982.
- J. Klensin, "Simple Mail Transfer Protocol," Internet Draft, draft-ietf-drums-02.txt, May 21, 1996.
- N. Borenstein et al., "MIME: Mechanisms for Specifying and Describing the Format of Internet Message Bodies," Network Working Group, RFC 1341, Jun. 1992.
- N. Borenstein, "MIME (Multipurpose Internet Mail Extensions) Part One: Mechanism for Specifying and Describing the Format of Internet Message Bodies," Network Working Group, RFC 1521, Sep. 1993.
- K. Moore, "MIME (Multipurpose Internet Mail Extensions) Part Two: Message Header Extensions for Non-ASCII Text," Network Working Group, RFC 1522, Sep. 1993.
- N. Freed, et al., "Definition of the URL MIME External-Body Access-Type," Network Working Group, Internet Draft of RFC 2017 (Apr. 11, 1995) see also N. Freed et al., "Definition of the URL MIME External-Body Access-Type," Network Working Group, RFC 2017, Oct. 1996.
- C. Manros, "New Internet Mail Functionality for Delivery Status Notifications," Messaging Magazine, Jul./Aug. 1995.
- K. Moore, "SMTP Service Extension for Delivery Status Notifications," Network Working Group, Internet-Draft of RFC 1891, Sep. 21, 1995.
- "Internet Engineering Task Force, R. Braden (ed.), "Requirements for Internet Hosts—Application and Support," Network Working Group, RFC 1123, Oct. 1989".
- J. Myers, et al., "Post Office Protocol-Version 3," Network Working Group, RFC 1725, Nov. 1994.
- K. Sollins et al., "Functional Requirements for Uniform Resource Names," Network Working Group, RFC 1737 Dec. 1994".
- T. Berners-Lee, "Universal Resource Identifier in WWW, A Unifying Syntax for the Expression and Address of Objects on the Network as used in the World-Wide Web," Network Working Group, RFC 1630, Jun. 1994".
- T. Berners-Lee, et al., "Uniform Resource Locators (URL)," Network Working Group, RFC 1738, Dec. 1994.
- T. Berners-Lee, et al., "Hypertext Markup Language-2.0," Network Working Group, RFC 1866, Nov. 1995.
- S. Bradner, "The Internet Standards Process—Revision 3," Network Working Group, RFC 2026, 1996.
- J. K. Reynolds, et al., "The DARPA Experimental Multimedia Mail System," Computer: 82-89, 1985.
- S. Baker, "Hypertext Browsing on the Internet," UNIX Review: 21-27, 1994.
- D.P. Dern, "Applying the Internet," BYTE Magazine, Feb. 1992.
- K.M. Savetz, "Magazines Without Paper," BYTE Magazine, Sep. 1993.
- S.J. Vaughan-Nichols, "The Web Means Business," BYTE Magazine, Nov. 1994.
- A. Singleton, "The Virtual Storefront," BYTE Magazine, Jan. 1995.
- J.R. Vacca, "Mosaic: Beyond Net Surfing," BYTE Magazine, Jan. 1995.
- B. Smith, "Internet with Style," BYTE Magazine, Jan. 1995.
- B. Smith, "Making the Internet Connection," BYTE Magazine, Jan. 1995.
- B. Friesenhahn, "Build Your Own WWW Server," BYTE Magazine, Apr. 1995.
- S.B. Jones, "Caught in the World Wide Web: MIT Moves Computer Documentation Online," Meet the Shadow Future: 187-189, 1994".
- S. Baker, "Mosaic-Surfing at Home and Abroad," Meet the Shadow Future: 159-163, 1994.
- R. J. Vetter et al., Mosaic, HTML, and the World Wide Web, IEEE Computer, 27, 1994.
- "University of Cambridge Statistical Laboratory," "Using Mosaic for Xwindows," Internet Publication, Jul. 1994, downloaded from <http://www.statslab.cam.ac.uk>.
- "New Features in Mosaic 2.0," Internet Publication, downloaded from <http://www.issi.com>, Dec. 1994.
- "World Wide Web Frequently Asked Questions," from URL http://sunsite.unc.edu/boutell/faq/www_faq.html, Dec. 9, 1994.
- "MHonArc Home Page updated Nov. 17, 1994 and MHonArc software manual published by Earl Hood <ehood@convex.com> Convex Computer Corporation, Richardson Texas".
- C. Liu, et al., "Managing Internet Information Services," World Wide Web, Gopher, FTP, and more: 357-359, Dec. 1994".
- J. December, et al., "The World Wide Web; Everything You Need to Master the Web!": 180-189-part I and 277-280 (part II), 1994".
- T. Berners-Lee, et al., "Hypertext Markup Language (HTML); A Representation of Textual Information and Meta-information for Retrieval and Interchange," Internet Draft, IIR Working Group, 1993".
- K. Reichard, "Leveraging E-Mail", PC Magazine: 241, 244 and 245, May 1995.
- "Lan-Aces, Inc. Announces Expanded Capabilities to Office-Logic Clerk Application," PR Newswire, May-Jun. 1994.
- "Working with AT&T Easylink, An Effective Communication Solution for Business," PC Today 62, May 1995.
- J. Davis, et al., "Drop-in Publishing With the World Wide Web," Computer Networks and ISDN Systems, 28, pp. 247-255, 1995.
- K. Goldberg, "Beyond the Web: Manipulating the Real World," Computer Networks and ISDN Systems, 28, pp. 209-219, 1995.
- A. N. Boston, et al., "Interactive species distribution reporting, mapping, and modelling using the World Wide Web," Computer Networks and ISDN Systems, 28, pp. 231-238, 1995.
- T. W. Yan, et al., "From user access patterns to dynamic hypertext linking," Computer Networks and ISDN Systems, 28, pp. 1007-1014, 1996.
- H. Pusch, "Design and implementation of a global reference mechanism for data objects," Computer Standards & Interfaces, 17, pp. 181-192, 1995.
- B. Wiegel, "Secure External References in Multimedia Email Messages," 3rd ACM Conference on Computer and Communications Security, New Delhi, Mar. 14-16, 1996.

- E. Levinson, "Exchanging SGML Documents Using Internet Mail and MIME," *Computer Standards & Interfaces*, 18, pp. 93-102, 1996".
- E. Meyer, et al., "Borealis Image Server," *Computer Networks and SDN Systems*, 28, pp. 1123-1137, 1996.
- M. Rio, et al., "A framework for broadcasting and management of URIs," *Computer Networks and ISDN Systems*, 28, pp. 535-542, 1996".
- Swartz, Barry K. and Stephen B. Weinstein, "Dual-Media Messaging Using Screen Telephones on the Telephone Network," *IEEE International Conference on Communications '93*, May 23-26, 1993, pp. 1183-1188, Technical Program; Conference Record, vol. 2/3.
- Borenstein, Nathaniel S., "Internet Multimedia Mail with MIME: Emerging Standards for Interoperability," *Upper Layer Protocols; Architectures and Applications*, 1992, pp. 183-192. Elsevier Science Publishers B.V. (North Holland).
- Supplementary European Search Report in European Patent Application No. EP 96 91 3855, search results mailed Nov. 22, 2001.
- Patel, Sanjiv P., et al., "The Multimedia Fax-MIME Gateway," *IEEE MULTIMEDIA JOURNAL*, Winter 1994, at 64-70.
- D. Nakamura, "AT&T introduces Most Comprehensive Fax-to-Data Service" dated Feb. 22, 1996, downloaded from Internet at <http://www.att.com/press/0296/960222.ela.html> on May 16, 1997.
- Biscom, "Biscom Introduces the E-fax Machine: the E-mail/Facsimile Solution 'for the Rest of Us,'" *FAXCOM*, Sep. 19, 1996.
- C3 Launches its Advanced Itmail Multi-medial Messaging System for Desk Top PC's Computer and Communications Company Ltd., Jun. 1993.
- "Digital Nate Fax2Net R5S 1-A Beginners Guide to Digital Mail Fax," *Digital Mail Limited*, Oct. 31, 1996.
- "Frequently Asked Questions", *Jfax Personal Telecom*, downloaded from Internet at www.jfax.net/faq.htm on Oct. 31, 1996.
- N. Ballard, "@ The Paperless Office", *Jfax Personal Telecom*, downloaded from the Internet at www.jfax.net/ballard1.htm on Oct. 31, 1996.
- J. Lyle, "Internet Fax Software: Internet Fax Utility Offers Simplified Faxing to E-Mail Addresses", *Lumina News*, Sep. 3, 1996, downloaded from the Internet at <http://lumina2000.com/lumina/press93.html> printed on Jun. 11, 1997.
- "Delivering Unified Messaging Solutions on the Internet", *Media Mail*, Nov. 2, 1996, downloaded from Internet at www.web.archive.org/web/1996121905113/http://mediamail.com on Mar. 2, 2005.
- "Methodology for Mail Delivery in a Multi-Media Environment," *IBM Technical Disclosure Bulletin*, Apr. 1993, pp. 507-508.
- "ScanFX-Scanning Hardware for Internet E-Mail," *Our Business Machines, Inc., OBM's Editorial Resource Chest*, Aug. 1996, Irwindale, CA.
- J. Kravitz, "SDML-Signed Document Markup Language," *Financial Services Technology Consortium, W3C Note* Jun. 19, 1998, downloaded from the Internet at www.w3.org, on Jun. 19, 1998.
- "Three Pronged Strategy for Octel, as it Integrates VMX and Moves from Core Market to New Territories," *Computergram International*, Aug. 1995, n.2719, *ComputerWire, Inc.*
- D. Rush, "ANNOUNCE: Voice Mail, Email & Fax Integration Over the Web," *Google Groups: biz.nextnewprod*. Mar. 19, 1996, <http://groups-beta.google.com/group/biznextnewprod/msg/db3c129fdo394667?dmode=source>, Mar. 2, 2005.
- D. Rush, "ANNOUNCE: Voice Mail, Email & Fax Integration Over the Web," *Google Groups: biz.nextnewprod*. Mar. 25, 1996, <http://groups-beta.google.com/group/biznextnewprod/msg/b85b59d49e92318b?dmode=source>, Mar. 2, 2005.
- R. Schookey, "Fax->E-Mail Plus Voice Mail Also?" *Google Groups*, <http://groups-beta.google.com/group/comp/dcom.telecom>. Dec. 28, 1995.
- R. Schookey, "Fax->E-Mail Plus Voice Mail Also?" *Google Groups*, <http://groups-beta.google.com/group/comp/dcom.telecom/msg/7db6ab0035e113c2?dmode=source>. Dec. 28, 1995.
- R. Schookey, "Fax->E-Mail Plus Voice Continued" *Google Groups*, <http://groups-beta.google.com/group/comp/dcom.telecom/msg/1a2c73a37bc90e6b?dmode=source>, Dec. 28, 1995.
- S. Sreenivasan "Cybertimes German Pop Singer Sets Sights on Virtual Office," Sep. 23, 1996, downloaded from *The New York Times CyberTime website*.
- Fax Mailbox, *PC Today*, Sep. 1994.
- Multimedia Fax-MIME Interworking, Patel, Henderson and Georganas, *IEEE*, 1994.
- "IBM Software Allows Phone Messages to be Retrieved Via Internet World Wide Web, press release, Nov. 23, 1995 (announcing product release)".
- MSN Hotmail Continues to Grow Faster than Any Media Company in History, press release, Feb. 8, 1999 (referencing Jul. 4, 1996 launch of Hotmail, which permitted users to access e-mail accounts through web browsers).
- "Wide Area Networking Puts Remote Offices On-Line," *Managing Office Technology*, Sep. 1994, pp. 49-50, 52, vol. 39, USA.
- M. Pop, "Comparative Study of Electronic Mail Systems," May 30, 1994.
- H. Chan et al., "Integrated Telephone/Fax/Paging/Email Services over ATM/MAN-based Personal Communication Networks," *Department of Electrical and Computer Engineering, The University of British Columbia. Vancouver. B. C., Canada.*
- Supplementary European Search Report in European Patent Application No. EP 9895 0859, Jun. 3, 2005.
- International Search Report in International Application No. PCT/US98/20732, Jan. 25, 1999.
- International Search Report in International Application No. PCT/US96/05910, Jul. 18, 1996.
- Critical Path Data Sheet—Critical Path Notification Server, 2 pages, Dec. 2002r.
- 500 Tips—Communications, *Windows Magazine*, pp. 1-7, WNDW 303, Issue: 412, Copyright 1993 CMP Publications, Inc., 2009 Facitive, Inc.
- 1997 RightFax Administration Guide.
- 1997 RightFax E-mail Gateway Guide.
- Larry Masinter, "Document Management, Digital Libraries and the Web", Jun. 9, 1995, <http://larry.masinter.net/docwebilb.html>, pp. 1-22.
- John Taylor, VP Engineering, *GammaLink*, "Building FAX into Computer Telephony Applications", *Computer Telephony Expo 95, Computer Fax 1995—Making Technology Work*, *GammaLink, A Dialogic Company*, 233 pages.
- "AT & T EasyLink Services and Visioneer offer easy integration of paper and electronic documents", 863 words, Nov. 28, 1994, *Business Wire, BWR, English*, Copyright 1994, *Business Wire*, pp. 1-2.
- "Lotus Ships Notes: Document Imaging Release 2; Office Imaging Made Easy and Affordable", 1,189 words, Nov. 22, 1993, *Business Wire, BWR, English*, Copyright 1993, *Business Wire*, pp. 1-4.
- "RightFAX Brings Award-Winning LAN Fax Software to Multi-Platform Environments With Web Client Module; Fax Server Software Leader Debuts New Module; Adds Remote Internet Connectivity to LAN Fax Server", *Business Wire*, Copyright 1996, Article dated: Oct. 11, 1996, pp. 1-2.
- Pascal R. Chesnais, Matthew J. Mucklo, and Jonathan A. Sheena, "The Fishwrap Personalized News System", *MIT Media Laboratory*, 20 Ames Street, Cambridge, Massachusetts, USA, pp. CAP-J2032982-989.
- Marc VanHeyningen, "New service: The Unified CS TR Index", *Computer Science Dept., Indiana University*, May 20, 1993, pp. 1-2.
- David H. Crocker, "RFC822—Standard For The Format of ARPA Internet Text Messages", *Dept. of Electrical Engineering, University of Delaware, Newark, DE* 19711, Aug. 13, 1982, pp. 1-39.
- James R. Davis, "A server for a distributed digital technical report library", *Xerox Corporation, Design Research Institute, 502 Theory Center, Cornell University, Ithaca, NY* 14853, davis@dri.cornell.edu, Jan. 15, 1994, pp. 1-8.
- James R. Davis, "Creating a Networked Computer Science Technical Report Library", *Design Research Institute, Xerox Corporation, 502, Rhodes Hall, Cornell University, Ithaca, NY* 14853, davis@dri.cornell.edu, *D-Lib Magazine*, Sep. 1995, pp. 1-5.
- Carl Lagoze and James R. Davis, "Dienst: An Architecture for Distributed Document Libraries", *Communications of the ACM*, Apr. 1995, vol. 38, No. 4, p. 47.

- Carl Loze, Erin Shaw, James R. Davis, Dean B. Krafft, "Dienst: Implementation Reference Manual", May 5, 1995, Computer Science Department, Cornell University, Ithaca, NY 14853, lagoze@cs.cornell.edu, shaw@cs.cornell.edu, dean@cs.cornell.edu, Xerox Corporation, Design Research Institute, Cornell University, Ithaca, NY 14853, davis@dri.cornell.edu., pp. 1-69.
- James R. Davis and Carl Lagoze, "Dienst, A Protocol for a Distributed Digital Document Library", Xerox, Cornell, Jul. 1994, pp. 1-14.
- Jim Davis and Carl Lagoze, "'Drop-in' publishing with the world Wide Web", Xeriox, Inc. and Cornell University, Jun. 6, 2007, pp. 1-12.
- Jeff Symoens, "Lotus' InterNotes Web Publisher speeds migration to the Web", Internet utility, Version 1.0, Lotus Development Corp., Cambridge, Mass, INFOWORLD Apr. 24, 1995.
- "DEFINITY Communications System Generic 3 Feature Description", AT & T, 555-230-204, Issue 3, Mar. 1996. 200 pages (Part 1 of 8).
- "DEFINITY Communications System Generic 3 Feature Description", AT & T, 555-230-204, Issue 3, Mar. 1996. 200 pages (Part 2 of 8).
- "DEFINITY Communications System Generic 3 Feature Description", AT & T, 555-230-204, Issue 3, Mar. 1996. 200 pages (Part 3 of 8).
- "DEFINITY Communications System Generic 3 Feature Description", AT & T, 555-230-204, Issue 3, Mar. 1996. 200 pages (Part 4 of 8).
- "DEFINITY Communications System Generic 3 Feature Description", AT & T, 555-230-204, Issue 3, Mar. 1996. 200 pages (Part 5 of 8).
- "DEFINITY Communications System Generic 3 Feature Description", AT & T, 555-230-204, Issue 3, Mar. 1996. 200 pages (Part 6 of 8).
- "DEFINITY Communications System Generic 3 Feature Description", AT & T, 555-230-204, Issue 3, Mar. 1996. 200 pages (Part 7 of 8).
- "DEFINITY Communications System Generic 3 Feature Description", AT & T, 555-230-204, Issue 3, Mar. 1996. 184 pages (Part 8 of 8).
- Asa Packer and Jay Scott, "The Perly Gateway version 0.1", Sep. 2, 1994, Subject: README, pp. 1-7.
- James C. French, John C. Knight and Allison L. Powell, "Applying Hypertext Structures To Software Documentation", Department of Computer Science, University of Virginia, Charlottesville, VA 22903, U.S.A., Information Processing & Management, vol. 33, No. 2, 1997, pp. 216-231.
- James C. French, John C. Knight and Allison L. Powell, "Hypertext Structures And Software Documentation", Technical Report CS-96-04, Department of Computer Science, University of Virginia, Feb. 1996, pp. 1-16.
- Jim French, University of Virginia, Edward Fox, Virginia Polytechnic Institute and University, Kurt Maly, Old Dominion University, and Alan L. Selman, State University of New York at Buffalo "Wide Area Technical Report Service—technical reports online", Aug. 2, 1994, pp. 122-127.
- Brian R. Gaines, "Supporting Collaboration through Multimedia Digital Document Archives", Knowledge Science Institute, University of Calgary, Version 1.0, Nov. 1994, pp. 1-53.
- Defendant Comodo Communications, Inc.'s Local Patent Rule 3-3 Invalidity Contentions in *j2 Global Communications, Inc. v. Comodo Communications, Inc.*, Case No. 6:08-cv-275.
- Hertzoff, Ira; AT&T Global Messaging, The At&T EasyLink Services Sourcebook, (ch. 7, 10, 11, 12).
- Intel NET SatisFAXtion Software Fax Administration Guide.
- K. Moore, "Representation of Non-ASCII Text in Internet Message Headers", Internet RFC 1342, Sep. 1993.
- Kaashoek, Dynamic Documents Mobile Wireless Access to the WWW, Sep. 15, 1994, MIT.
- RightFax Installation & Administration Guide 1996.
- RightFax Introduces New Fax Server Designed for the Enterprise; Rightfax News Release (May 27, 1997).
- RightFax User's Guide 1996.

* cited by examiner

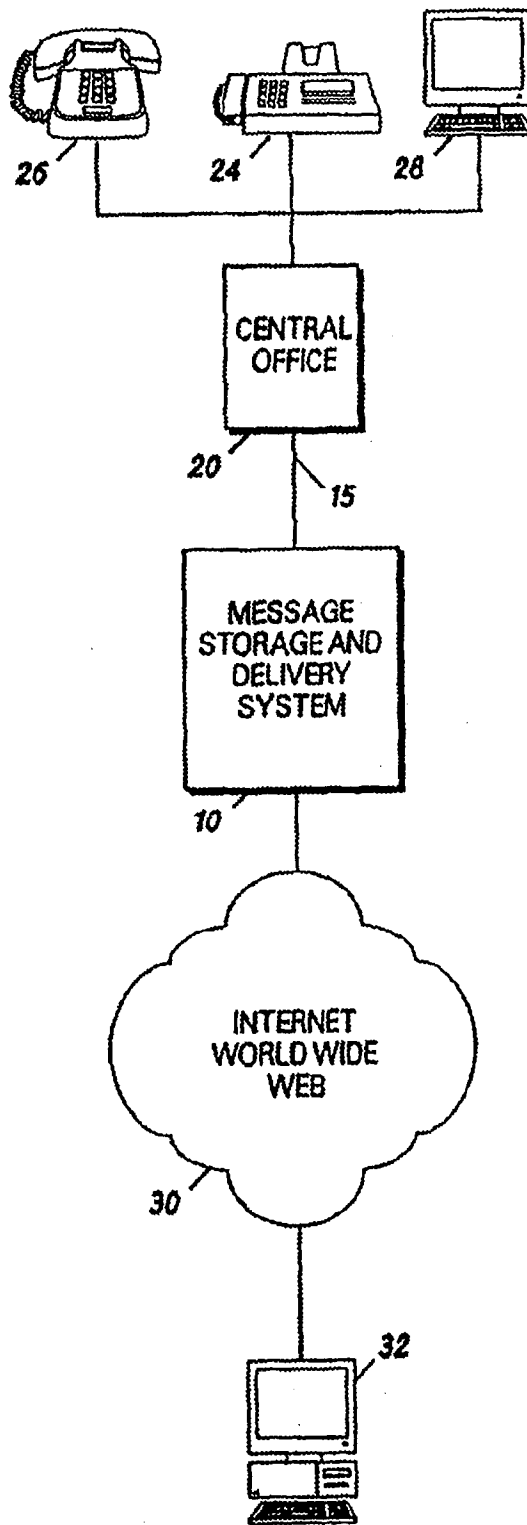

FIG 1

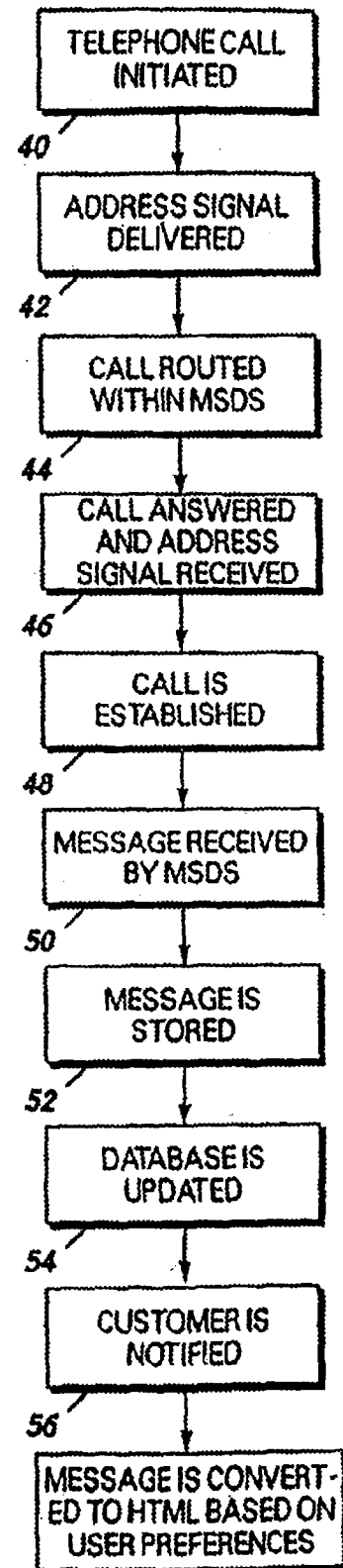

FIG 2

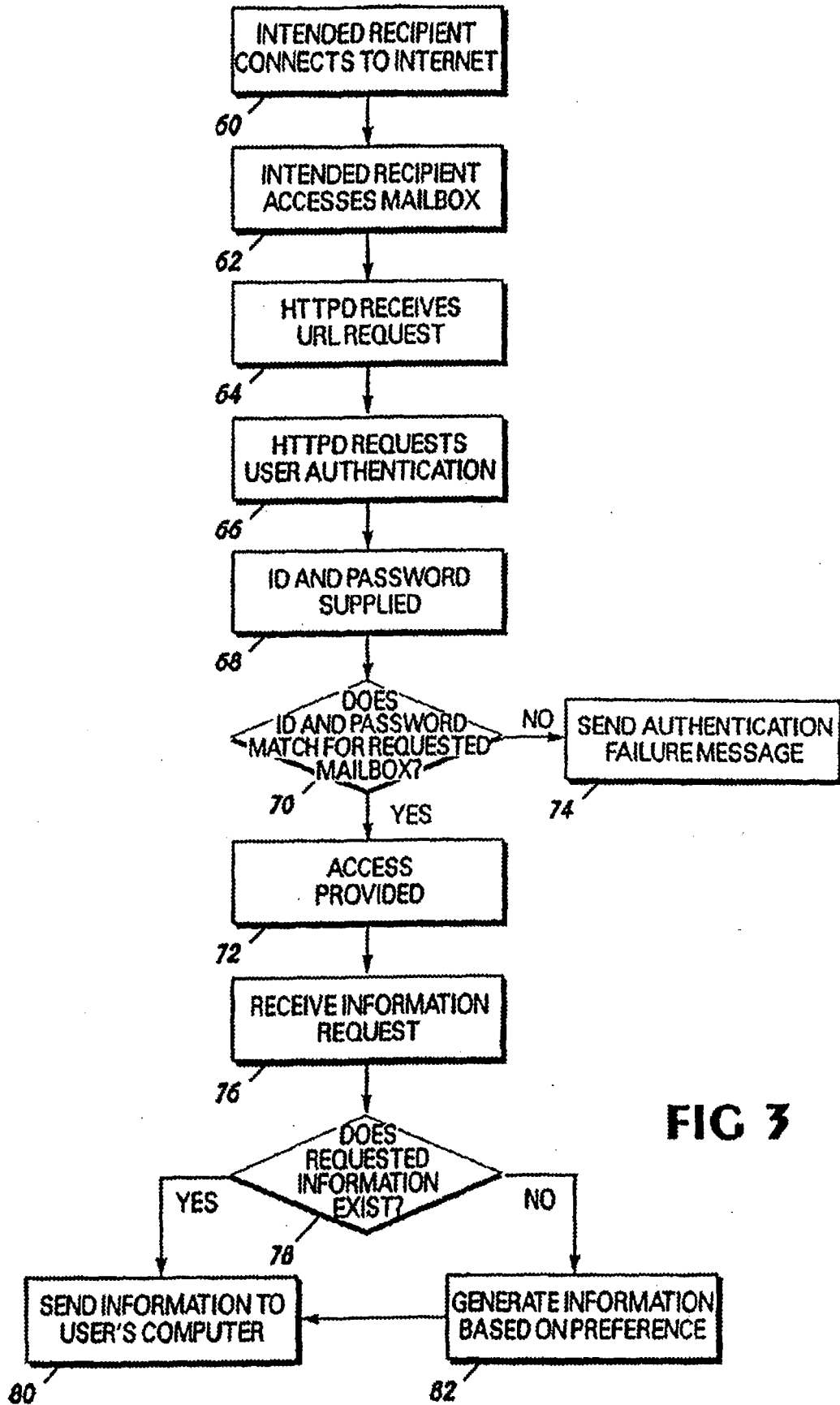

FIG 3

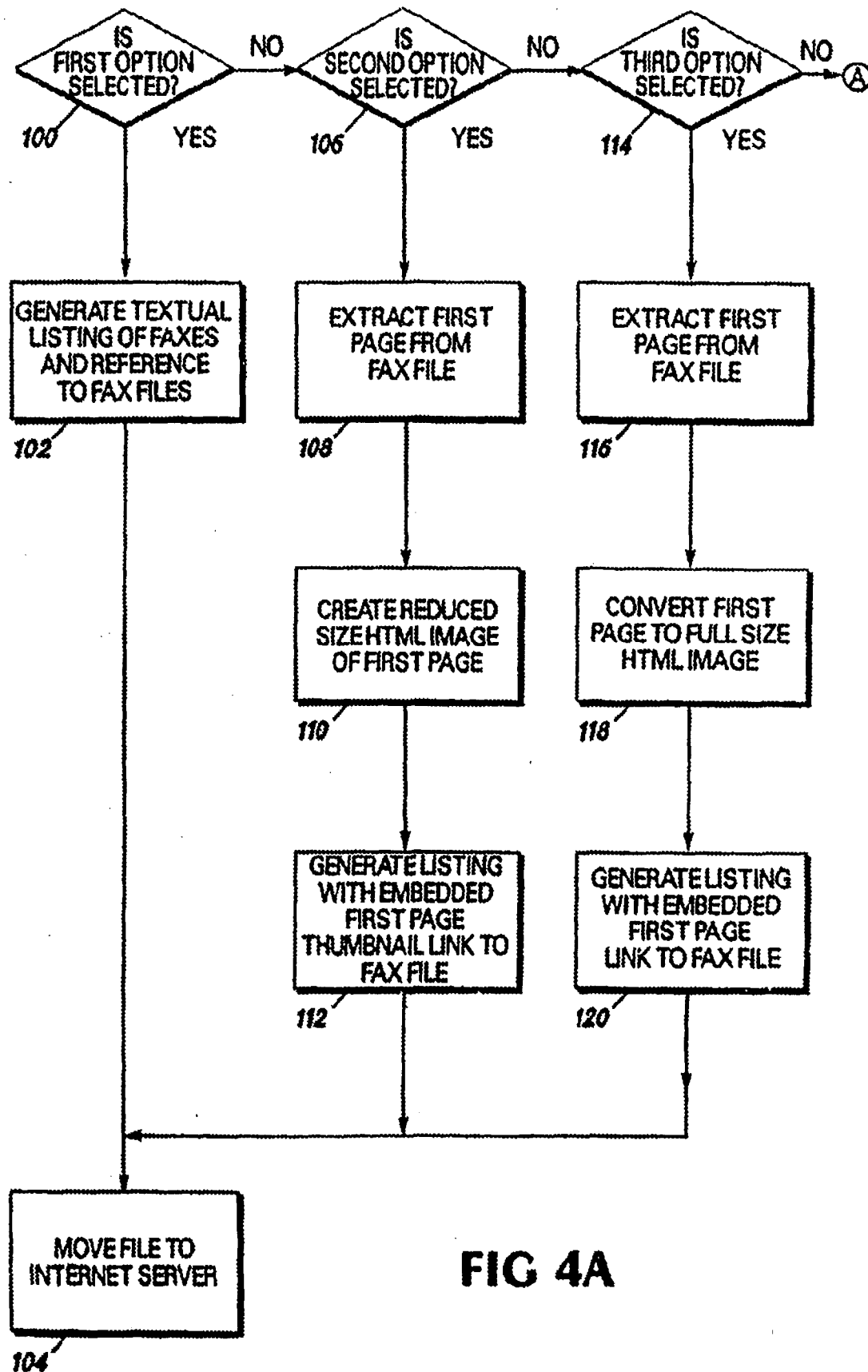
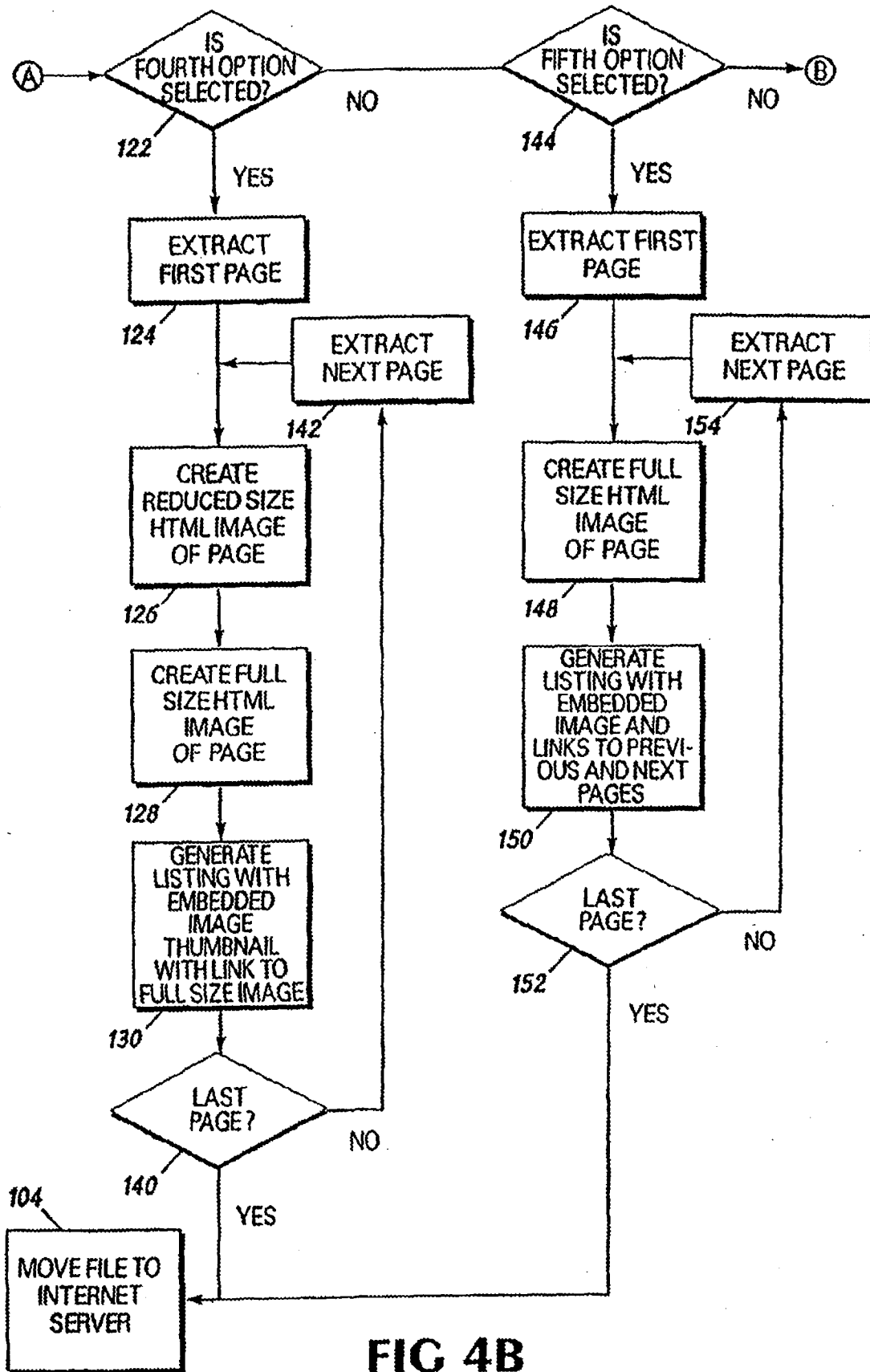

FIG 4A



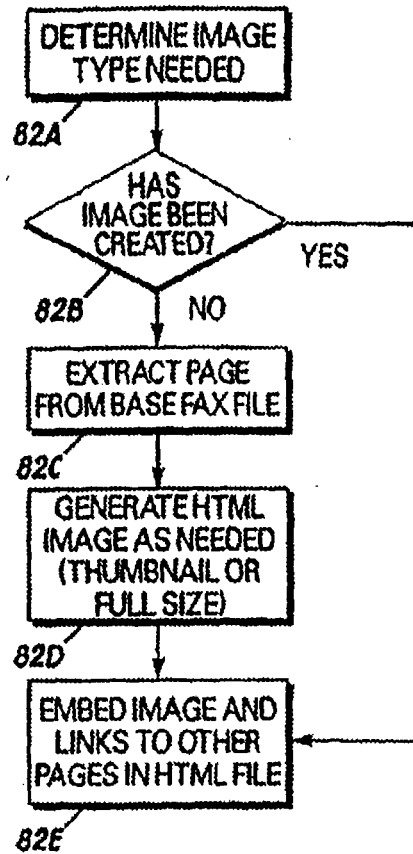

FIG 5

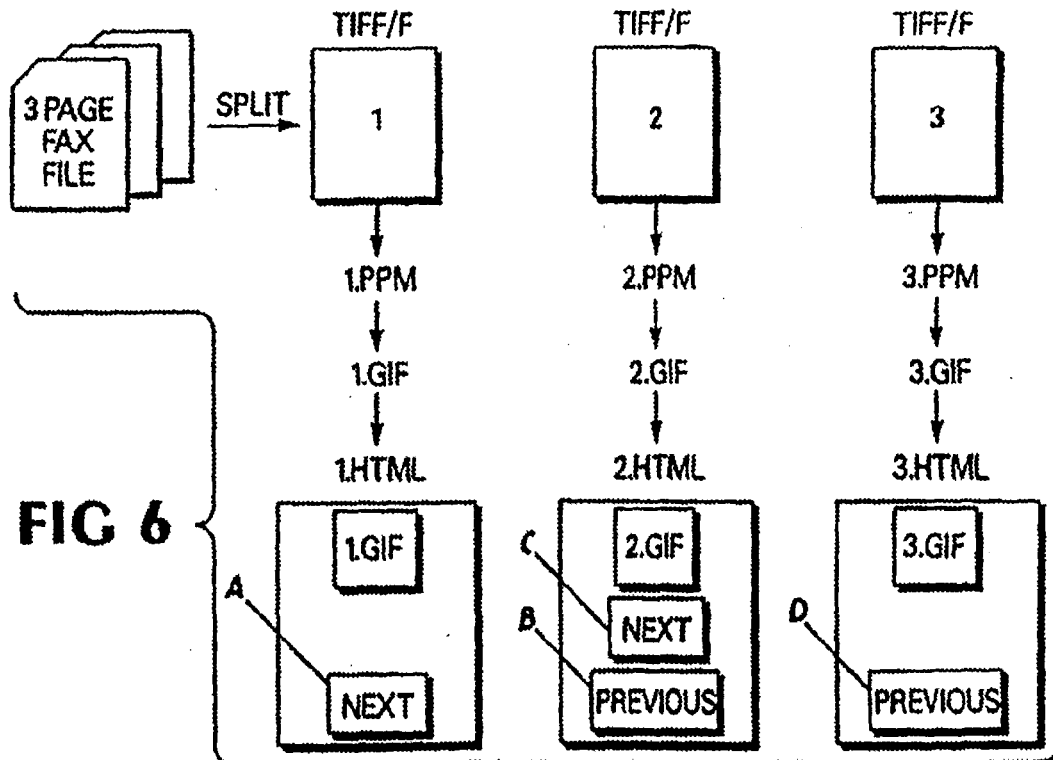

FIG 6

Fax from (404)249-6801

Received on May 31, 1995 at 1:58 PM
Page 1 of 3

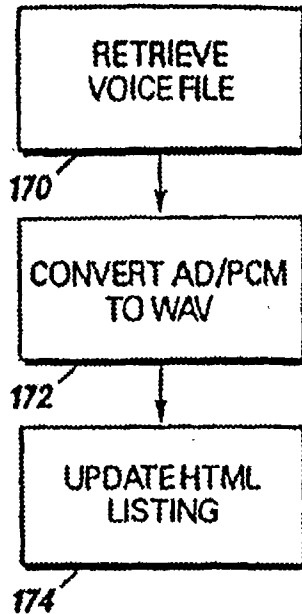
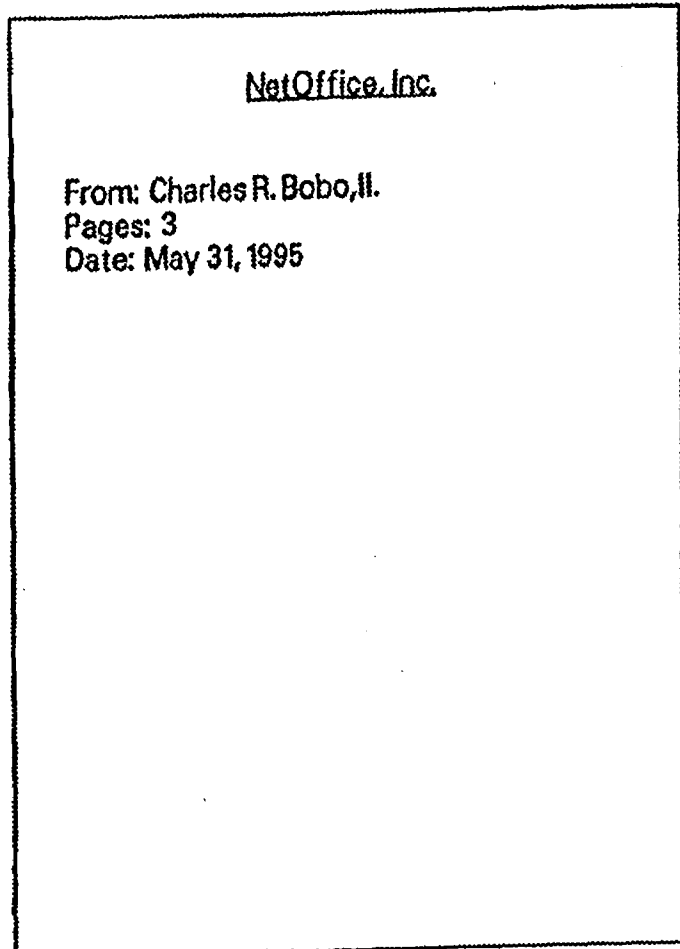

FIG 8

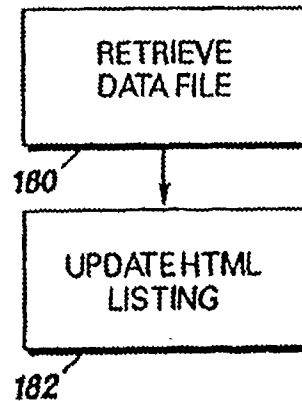

FIG 9

Next Page

Return to Fax Listing

This page was automatically generated by FaxWeb(tm) On May 31, 1995 at 2:05pm.
©1995 NetOffice, inc.

NetOffice, inc.
PO Box 7115
Atlanta, GA 30357
info@netoffice.com

FIG 7

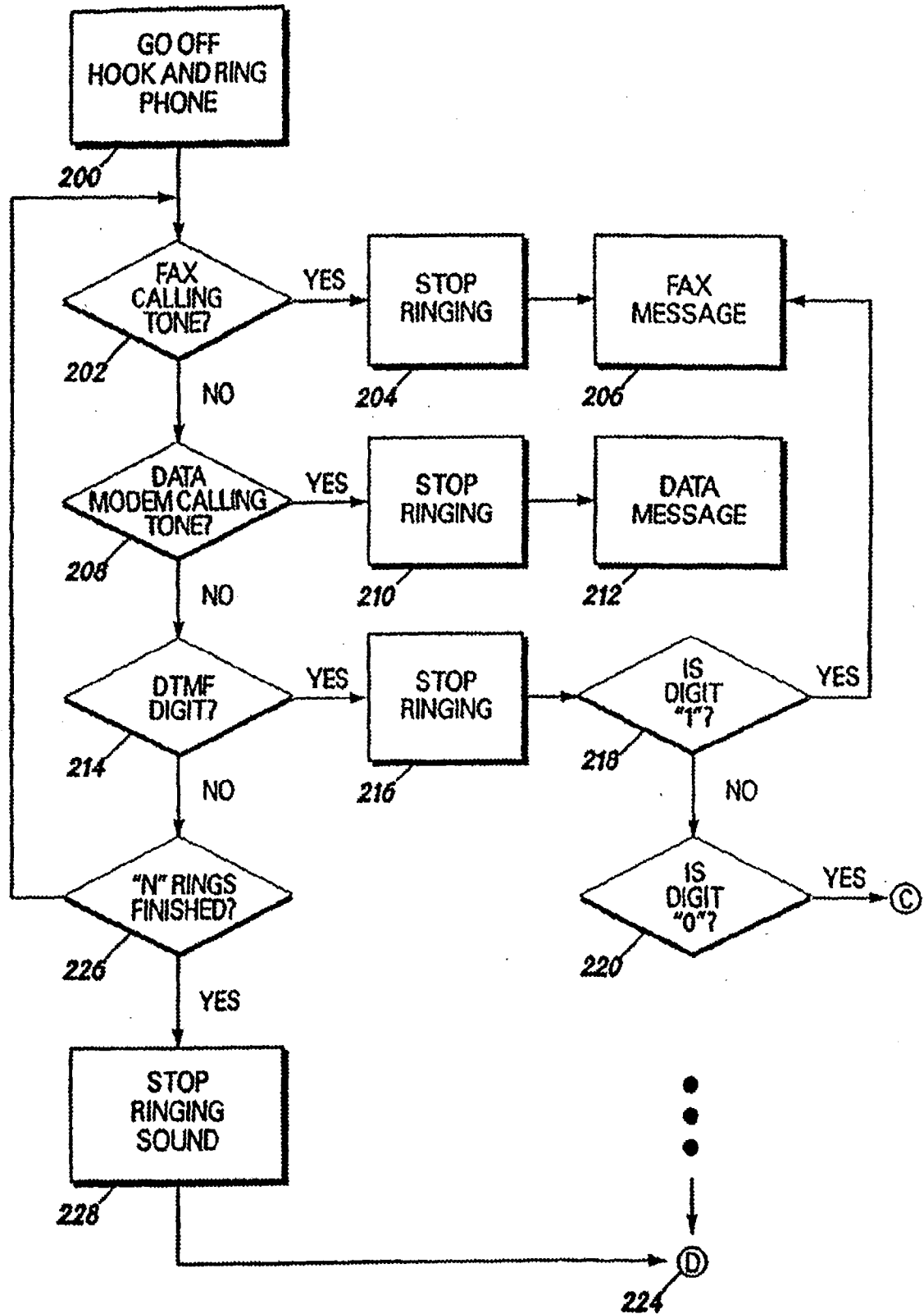

FIG 10

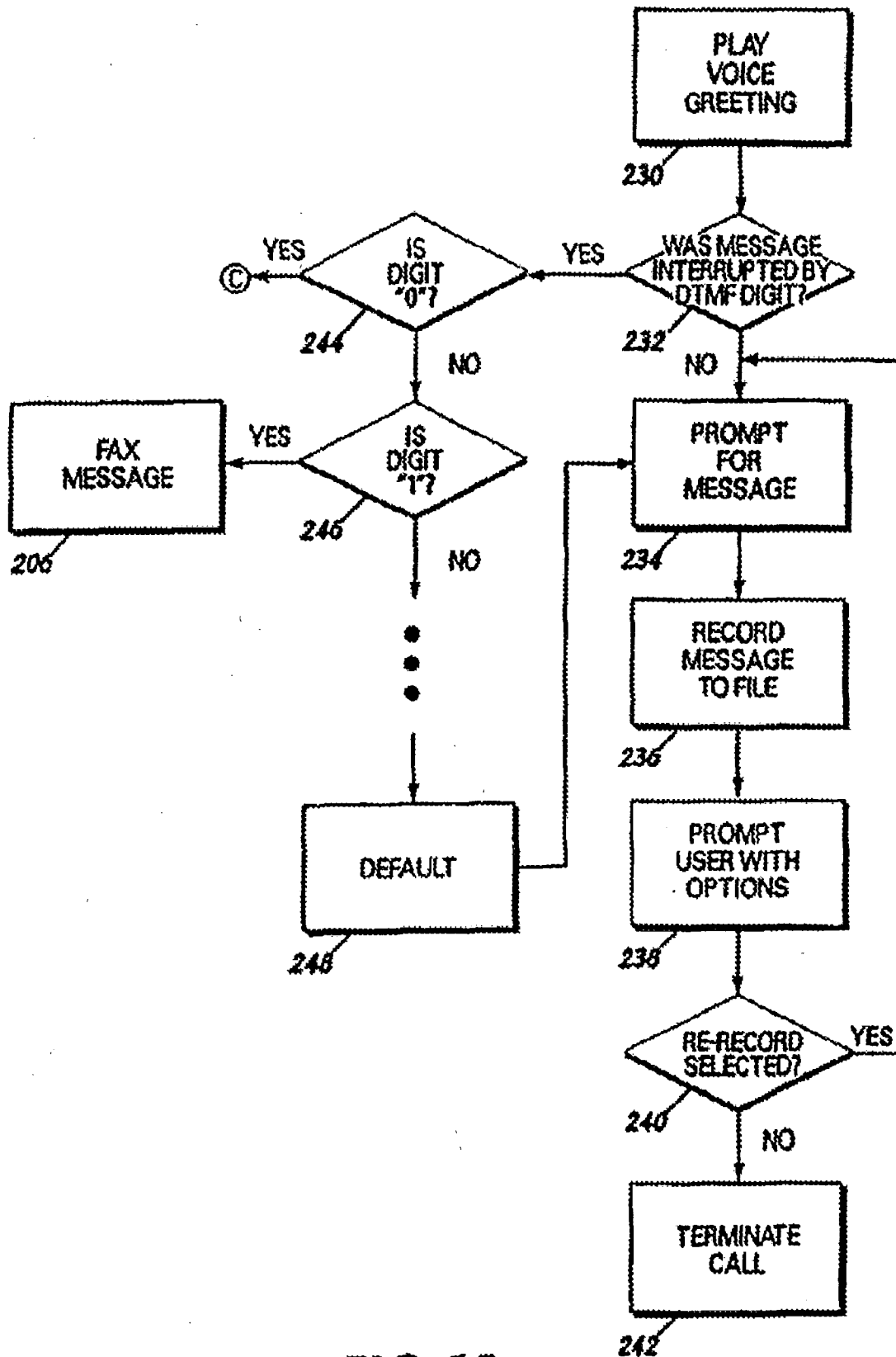

FIG 11

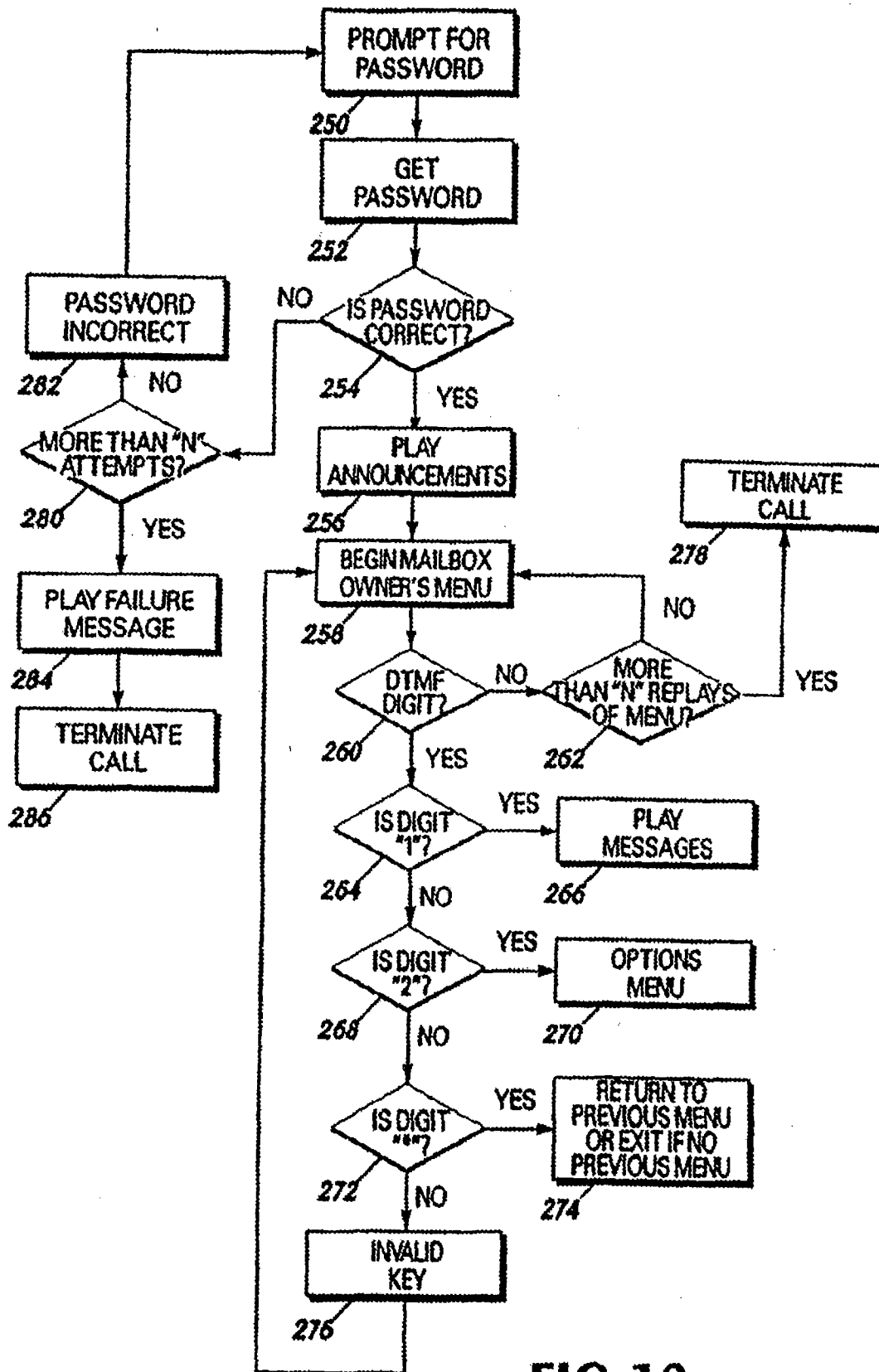

FIG 12

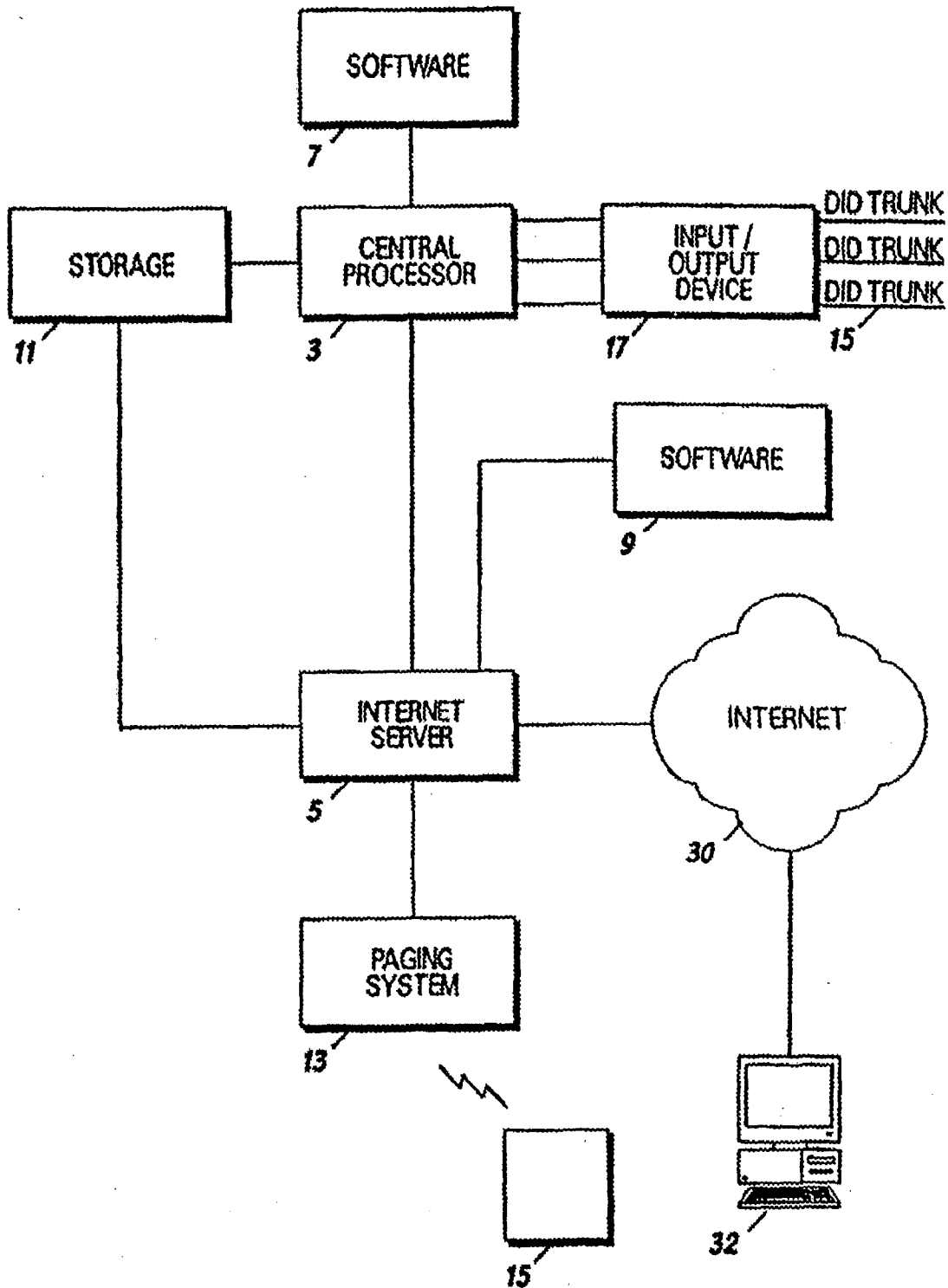

FIG 13

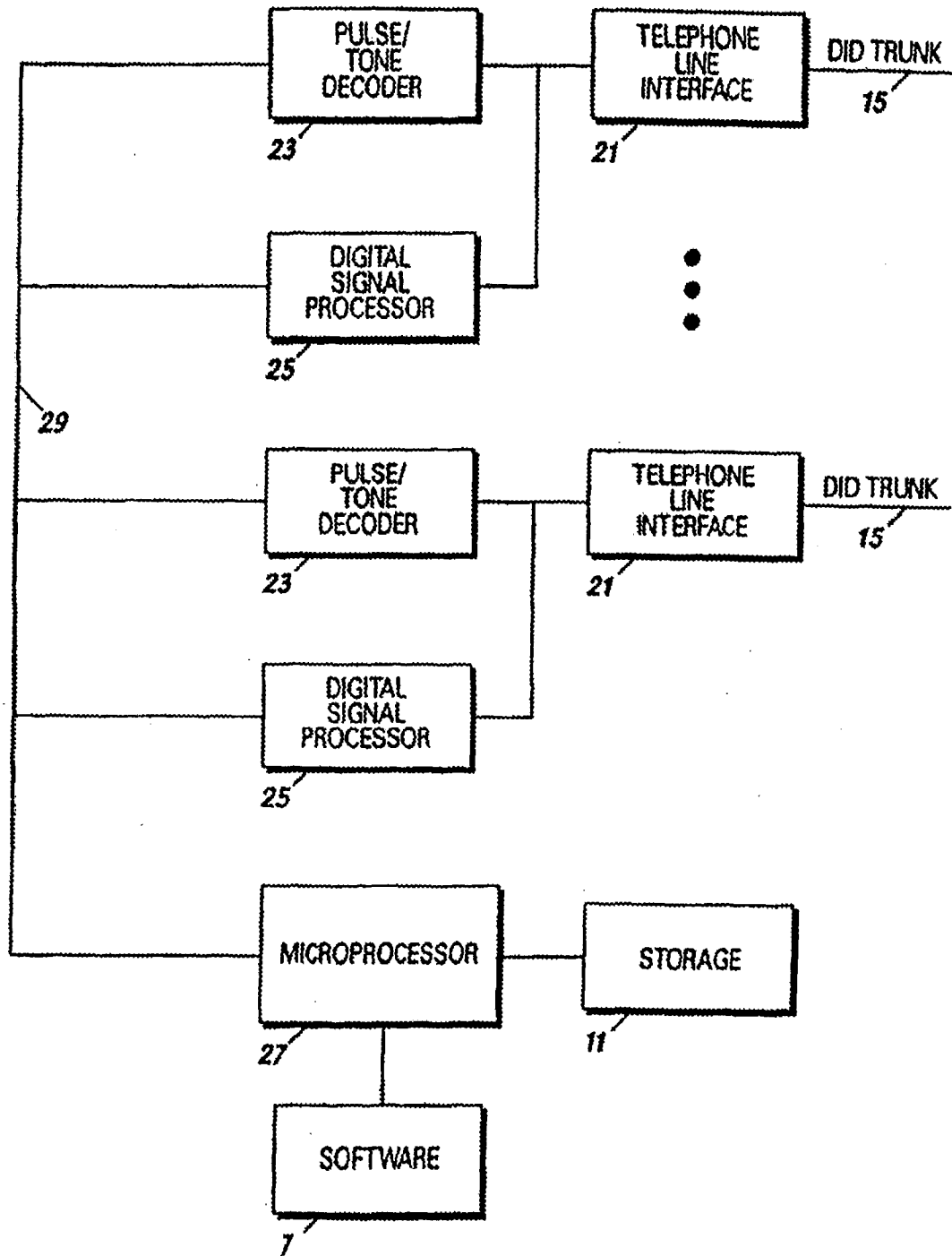

FIG 14

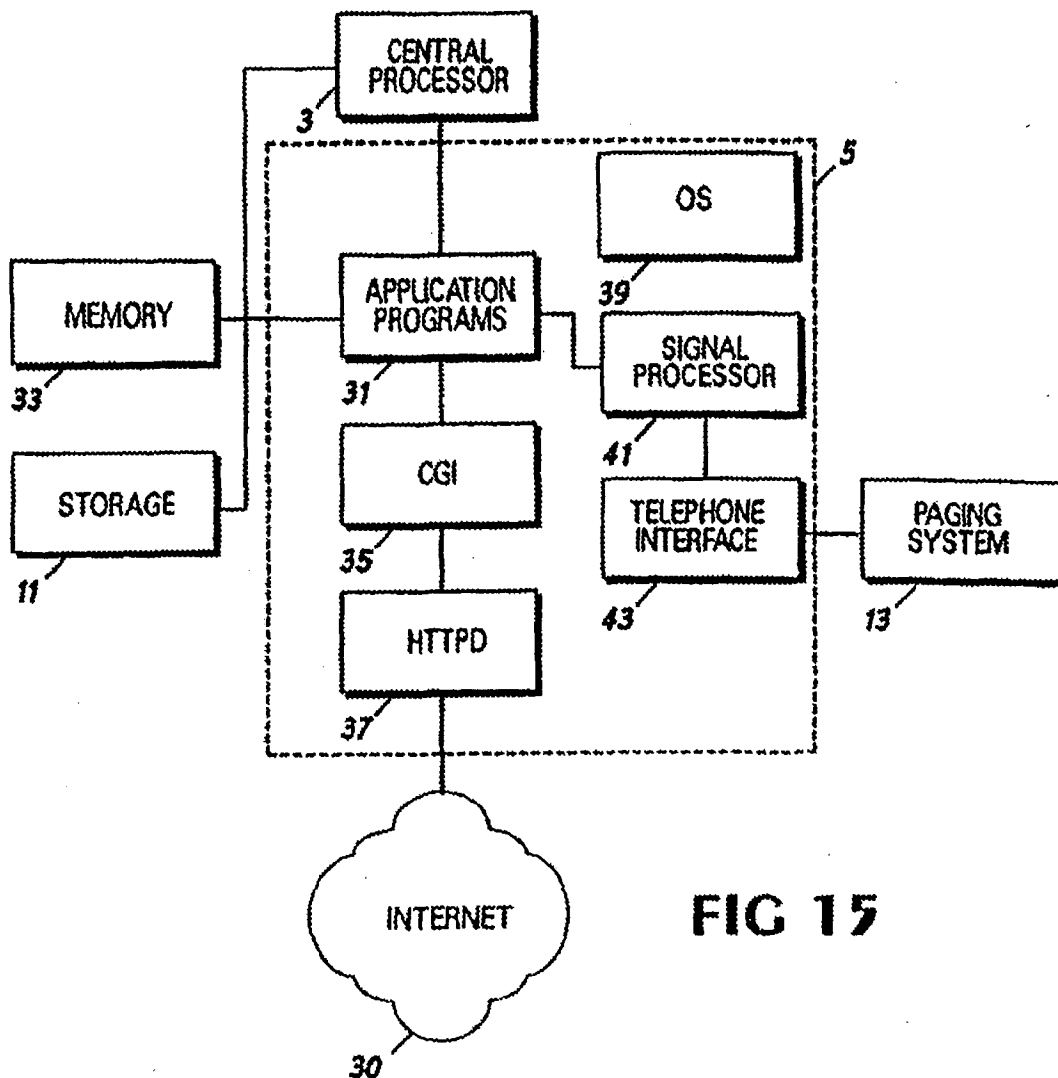

FIG 15

INDIVIDUAL APPLICATION PROGRAMS
COMMON GATEWAY INTERFACE (CGI)
HTTPD
INTERNET DEAMON (INETD)
OPERATING SYSTEM (OS)
TCP/IP

FIG 16A

PREFORMATTED HTML FILE
HTTPD
INETD
OS
TCP/IP

FIG 16B

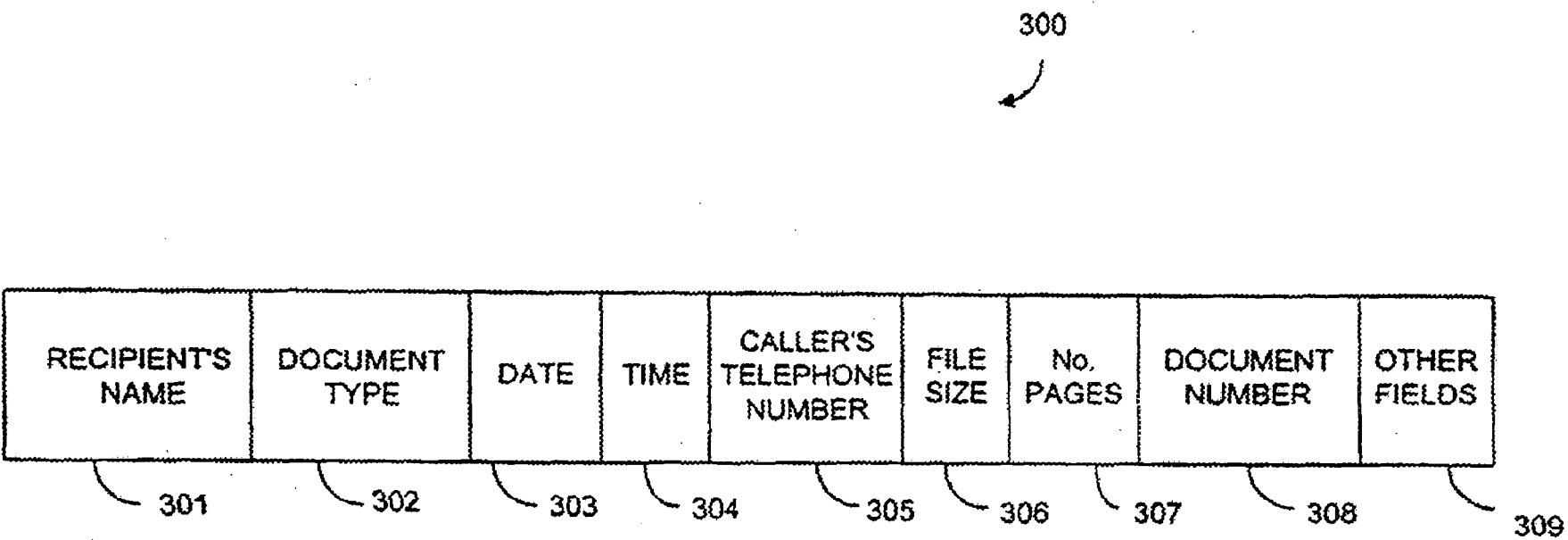

FIG. 17

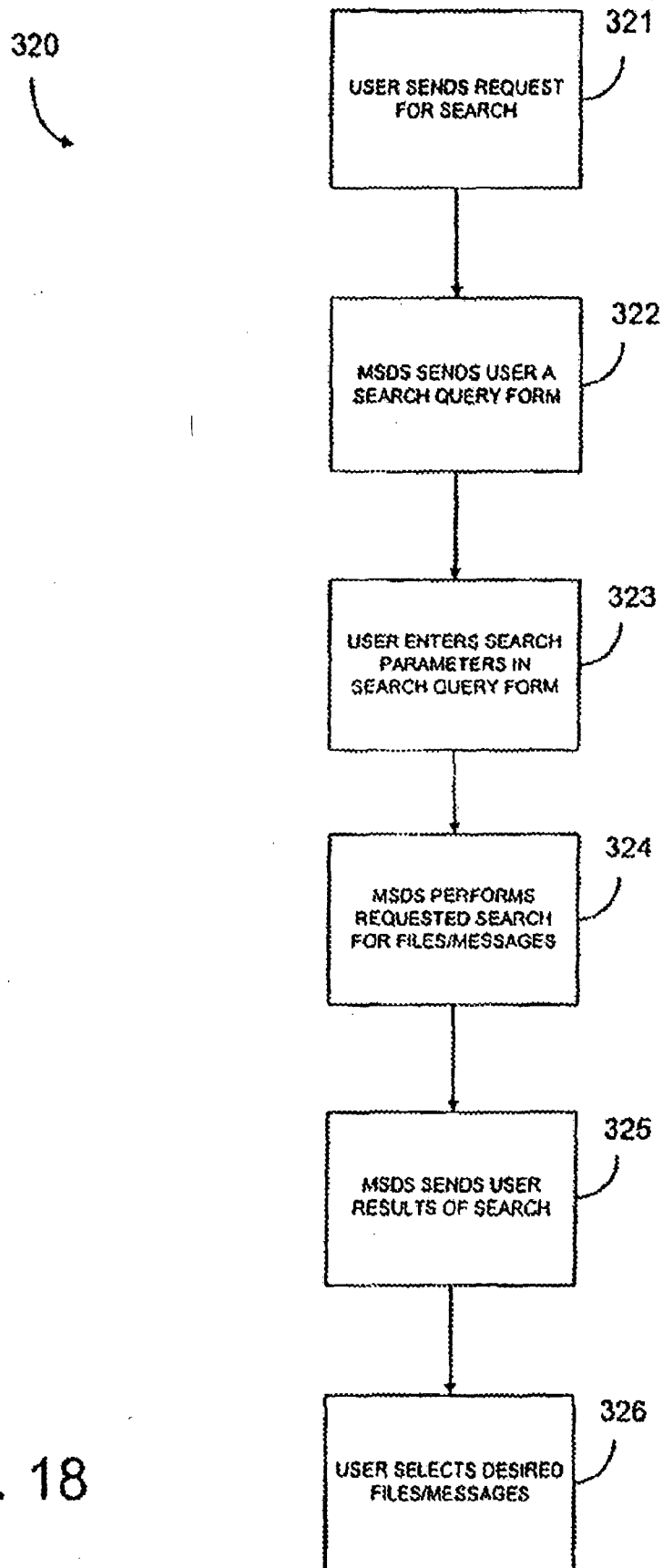



FIG. 18

SEARCH QUERY

RECIPIENT'S NAME: 

DOCUMENT TYPE: 

DATE:

TIME:

CALLING NO.:

FILE SIZE:

NO. PAGES:

DOCUMENT NO.:

OTHER FIELD: 

SEARCH RECENT FILES

STORED
SEARCH GROUP HELP

FIG. 19

SEARCH QUERY

RECIPIENT'S NAME: 

DOCUMENT TYPE: 

DATE:

TIME:

CALLING NO.:

FILE SIZE:

NO. PAGES:

DOCUMENT NO.:

OTHER FIELD: 

SEARCH RECENT FILES

STORED SEARCHES HELP

FIG. 20

SEARCH RESULTS

1. Document No. 11: Facsimile from (404) 249-6801 to Jane Doe on May 31, 1995. 3 Pages
2. Document No. 243: Facsimile from (404) 249-6801 to Jane Doe on July 16, 1995. 21 Pages
3. Document No. 1002: Facsimile from (404) 249-6801 to Jane Doe on January 1, 1996. 10 Pages

SAVE SEARCH AS:

CHARLES R. BOBO FACSIMILES

HELP

FIG. 21

STORED
SEARCHES

1. CHARLES R. BOBO FACSIMILES

2. CHARLES R. BOBO VOICE MESSAGES

3. DATA TRANSFERS FROM 01-01-96 TO 6-01-96 TO
JANE DOE

HELP

FIG. 22

SYSTEMS AND METHOD FOR STORING, DELIVERING, AND MANAGING MESSAGES

The present application is a continuation of U.S. application Ser. No. 10/963,586 filed Oct. 14, 2004, which is a continuation of U.S. application Ser. No. 10/436,798 filed May 12, 2003, now U.S. Pat. No. 6,857,074, which is a continuation of U.S. application Ser. No. 09/840,759 filed Apr. 23, 2001, now U.S. Pat. No. 6,564,321, which is a continuation of U.S. application Ser. No. 09/186,595 filed Nov. 5, 1998, now U.S. Pat. No. 6,350,066, which is a continuation of U.S. application Ser. No. 08/944,741 filed Oct. 6, 1997, now U.S. Pat. No. 5,870,549, which is a continuation-in-part of U.S. application Ser. No. 08/431,716 filed Apr. 28, 1995, now U.S. Pat. No. 5,675,507.

FIELD OF THE INVENTION

This invention relates to system(s) and method(s) for storing and delivering messages and, more particularly, to system(s) and method(s) for storing messages and for delivering the messages through a network, such as the Internet, or a telephone line to an intended recipient. In another aspect, the invention relates to system(s) and method(s) for storing, delivering, and managing messages or other files, such as for archival purposes or for document tracking.

BACKGROUND OF THE INVENTION

Even though the facsimile machine is heavily relied upon by businesses of all sizes and is quickly becoming a standard piece of office equipment many businesses or households cannot receive the benefits of the facsimile machine. Unfortunately, for a small business or for a private household, a facsimile machine is a rather expensive piece of equipment. In addition to the cost of purchasing the facsimile machine, the facsimile machine also requires toner, paper, maintenance, as well as possible repairs. These expenses may be large enough to prevent many of the small businesses and certainly many households from benefiting from the service that the facsimile machine can provide for others who are constantly traveling and who do not have an office, it may be impractical to own a facsimile machine. In fact, the Atlanta Business Chronicle estimates that 30% of the small businesses do not have any facsimile machines. Therefore, many businesses and households are at a disadvantage since they do not have access to a facsimile machine.

Because a facsimile machine can be such an asset to a company and is heavily relied upon to quickly transmit and receive documents, a problem exists in that the machines are not always available to receive a facsimile message. At times, a facsimile machine may be busy receiving another message or the machine may be transmitting a message of its own. During these times, a person must periodically attempt to send the message until communication is established with the desired facsimile machine. This inability to connect with a facsimile machine can be frustrating, can consume quite a bit of the persons time, and prevent the person from performing more productive tasks. While some more advanced facsimile machines will retry to establish communication a number of times, a person will still have to check on the facsimile machine to ensure that the message was transmitted or to re-initiate the transmission of the message.

In addition to labor costs and a reduction in office efficiency, a facsimile machine may present costs to businesses that are not readily calculated. These costs include the loss of business or the loss of goodwill that occurs when the fac-

simile machine is not accessible by another facsimile machine. These costs can occur for various reasons, such as when the facsimile machine is out of paper, when the machine needs repairing, or when the facsimile machine is busy with another message. These costs occur more frequently with some of the smaller businesses, who are also less able to incur these expenses, since many of them have a single phone line for a telephone handset and the facsimile machine and thereby stand to lose both telephone calls and facsimile messages when the single line is busy. In fact, the Atlanta Business Chronicle estimated that fewer than 5% of the small businesses have 2 or more facsimile machines. Many of the larger companies can reduce these losses by having more than one facsimile machine and by having calls switched to another machine when one of the machines is busy. These losses, however, cannot be completely eliminated since the machines can still experience a demand which exceeds their capabilities.

A main benefit of the facsimile machine, namely the quick transfer of documents, does not necessarily mean that the documents will quickly be routed to the intended recipient. The facsimile machines may be unattended and a received facsimile message may not be noticed until a relatively long period of time has elapsed. Further, even for those machines which are under constant supervision, the routing procedures established in an office may delay the delivery of the documents. It is therefore a problem in many offices to quickly route the facsimile message to the intended recipient.

The nature of the facsimile message also renders it difficult for the intended recipient to receive a sensitive message without having the message exposed to others in the office who can intercept and read the message. If the intended recipient is unaware that the message is being sent, other people may see the message while it is being delivered or while the message remains next to the machine. When the intended recipient is given notice that a sensitive message is being transmitted, the intended recipient must wait near the facsimile machine until the message is received. It was therefore difficult to maintain the contents of a facsimile message confidential.

In an office with a large number of employee it may also be difficult to simply determine where the facsimile message should be routed. In light of this difficulty, some systems have been developed to automatically route facsimile messages to their intended recipient. One type of system, such as the one disclosed in U.S. Pat. No. 5,257,112 to Okada, can route an incoming call to a particular facsimile machine based upon codes entered with telephone push-buttons by the sender of the message. Another type of system, such as the one disclosed in U.S. Pat. No. 5,115,326 to Burgess et al. or in U.S. Pat. No. 5,247,591 to Baran, requires the sender to use a specially formatted cover page which is read by the system, this type of system, however, burdens the sender, who may very well be a client or customer, by requiring the sender to take special steps or additional steps to transmit a facsimile message. These systems are therefore not very effective or desirable.

Another type of routing system links a facsimile machine to a Local Area Network (LAN) in an office. For instance, in the systems disclosed in the patents to Baran and Burgess et al., after the system reads the cover sheet to determine the intended recipient of the facsimile message, the systems send an E-mail message to the recipient through the local network connecting the facsimile machine to the recipient's computer. Other office systems, such as those in U.S. Pat. No. 5,091,790 to Silverberg and U.S. Pat. No. 5,291,546 to Giler et al., are linked to the office's voice mail system and may leave a message with the intended recipient that a facsimile message

has been received. Some systems which are even more advanced such as those in U.S. Pat. No. 5,317,628 to Misholi et al. and U.S. Pat. No. 5,333,266 to Boaz et al., are connected to an office's local network and provide integrated control of voice messages, E-mail messages, and facsimile messages.

The various systems for routing facsimile messages, and possibly messages of other types received in the office, are very sophisticated and expensive systems. While these office systems are desirable in that they can effectively route the messages at the office to their intended recipients, the systems are extremely expensive and only those companies with a great number of employees can offset the costs of the system with the benefits that the system will provide to their company. Thus, for most businesses, it still remains a problem to effectively and quickly route messages to the intended recipients. It also remains a problem for most businesses to route the messages in a manner which can preserve the confidential nature of the messages.

Even for the businesses that have a message routing system and especially for those that do not have any type of system, it is usually difficult for a person to retrieve facsimile messages while away from the office. Typically, a person away on business must call into the office and be informed by someone in the office as to the facsimile messages that have been received. Consequently, the person must call into the office during normal business hours while someone is in the office and is therefore limited in the time that the information in a facsimile message can be relayed.

If the person away on business wants to look at the facsimile message, someone at the office must resend the message to a facsimile machine accessible to that person. Since this accessible machine is often a facsimile machine at another business or at a hotel where the person is lodging, it is difficult for the person to receive the facsimile message without risking disclosure of its contents. Further, since someone at the person's office must remember to send the message and since someone at the accessible facsimile machine must route the message to the person away from the office, the person may not receive all of the facsimile messages or may have to wait to receive the messages.

The retrieval of facsimile messages, as well as voice mail messages, while away from the office is not without certain costs. For one, the person often must incur long distance telephone charges when the person calls the office to check on the messages and to have someone in the office send the messages to another facsimile. The person will then incur the expenses of transmitting the message to a fax bureau or hotel desk as well as the receiving location's own charges for use of their equipment. While these charges are certainly not substantial, the charges are nonetheless expenses incurred while the person is away from the office.

Overall, while the facsimile machine is an indispensable piece of equipment for many businesses, the facsimile machine presents a number of problems or costs. Many businesses or households are disadvantaged since they are unable to reap the benefits of the facsimile machine. For the businesses that do have facsimile machines, the businesses must incur the normal costs of operating the facsimile machine in addition to the costs that may be incurred when the facsimile machine or machines are unable to receive a message. Further, the facsimile messages may not be efficiently or reliably routed to the intended recipient and may have its contents revealed during the routing process. The costs and problems in routing a facsimile message are compounded when the intended recipient is away from the office.

Many of the problems associated with facsimile messages are not unique to just facsimile messages but are also associ-

ated with voice mail messages and data messages. With regard to voice messages, many businesses do not have voice mail systems and must write the message down. Thus, the person away from the office must call in during normal office hours to discover who has called. The information in these messages are usually limited to just the person who called, their number, and perhaps some indication as to the nature of the call. For those businesses that have voice mail, the person away from the office must call in and frequently incur long distance charges. Thus, there is a need for a system for storing and delivery voice messages which can be easily and inexpensively accessed at any time.

With regard to data messages, the transmission of the message often requires some coordination between the sender and the recipient. For instance, the recipient's computer must be turned on to receive the message, which usually occurs only when someone is present during normal office hours. Consequently, the recipient's computer is usually only able to receive a data message during normal office hours. Many households and also businesses may not have a dedicated data line and must switch the line between the phone, computer, and facsimile. In such a situation, the sender must call and inform the recipient to switch the line over to the computer and might have to wait until the sender can receive the message. The retransmission of the data message to another location, such as when someone is away from the office, only further complicates the delivery. It is therefore frequently difficult to transmit and receive data messages and is also difficult to later relay the messages to another location.

A standard business practice of many companies is to maintain records of all correspondence between itself and other entities. Traditionally, the correspondence that has been tracked and recorded includes letters or other such printed materials that is mailed to or from a company to the other entity. Although tracking correspondence of printed materials is relatively easy, non-traditional correspondence, such as facsimile messages, e-mail messages, voice messages, or data messages, are more difficult to track and record.

For example, facsimile messages may be difficult to track and record since the messages may be received on thermal papers which suffers from a disadvantage that the printing fades over time. Also, accurate tracking of facsimile messages is difficult since the facsimile messages may only be partially printed at the facsimile machine or the messages may be lost or only partially delivered to their intended recipients. Facsimile messages also present difficulties since they are often delivered within an organization through different channels than ordinary mail and thus easily fall outside the normal record keeping procedures of the company.

Voice mail messages are also difficult to track and record. Although voice messages can be saved, many voice mail servers automatically delete the messages after a certain period of time. To maintain a permanent record of a voice message, the voice message may be transcribed and a printed copy of the message may be kept in the records. This transcribed copy of the voice message, however, is less credible and thus less desirable than the original voice message since the transcribed copy may have altered material or may omit certain portions of the message.

In addition to facsimile and voice mail messages, data messages are also difficult to track and record. A download or upload of a file may only be evident by the existence of a file itself. A file transfer procedure normally does not lend itself to any permanent record of what file was transferred the dialed telephone number, the telephone number of the computer receiving the file, the time, or the date of the transfer. It is

5

therefore difficult to maintain accurate records of alt data transfers between itself and another entity.

SUMMARY OF THE INVENTION

It is an object of the invention to reliably and efficiently route messages to an intended recipient.

It is another object of the invention to route messages to the intended recipient while maintaining the contents of the message confidential.

It is another object of the invention to enable the intended recipient to access the messages easily and with minimal cost.

It is a further object of the invention to permit the simultaneous receipt of more than one message on behalf of the intended recipient.

It is a further object of the invention to enable the intended recipient of a message to access the message at any time and at virtually any location world-wide.

It is yet a further object of the invention to enable the intended recipient of a message to browse through the received messages.

It is yet a further object of the invention to quickly notify an intended recipient that a message has been received.

It is still another object of the invention to receive messages of various types.

It is still another object of the invention to deliver messages according to the preferences of die intended recipient.

It is still a further object of the invention to record and track correspondence, such as facsimile messages, voice mail messages, and data transfers.

Additional objects, advantages and novel features of the invention will be set forth in the description which follows, and will become apparent to those skilled in the art upon reading this description or practicing the invention. The objects and advantages of the invention may be realized and attained by the appended claims.

To achieve the foregoing and other objects, in accordance with the present invention, as embodied and broadly described herein, a system and method for storing and delivering messages involves receiving an incoming call and detecting an address signal associated with the incoming call, the address signal being associated with a user of the message storage and delivery system. A message accompanied with the address signal is then received and converted from a first file format to a second file format. The message is stored in the second file format within a storage area and is retrieved after a request has been received from the user. At least a portion of the message is then transmitted to the user over a network with the second file format being a mixed media page layout language.

In another aspect, a network message storage and delivery system comprises a central processor for receiving an incoming call, for detecting an address signal on the incoming call, for detecting a message on the incoming call, and for placing the message in a storage area. The address signal on the incoming call is associated with a user of the network message storage and delivery system. A network server receives the message from the storage area, converts the message into a mixed media page layout language, and places the message in the storage area. When the network server receives a request from the user over the network, the network server transmits at least a portion of the message over the network to the user.

Preferably, the network storage and delivery system can receive facsimile messages, data messages, or voice messages and the network is the Internet. The messages are converted into a standard generalized mark-up language and the

6

user is notified that a message has arrived through E-mail or through a paging system. A listing of the facsimile messages may be sent to the user in one of several formats. These formats include a textual only listing or a listing along with a full or reduced size image of the first page of each message. A full or reduced size image of each page of a message in the listing may alternatively be presented to the user.

According to a further aspect, the invention relates to a system and method for managing files or messages and involves storing message signals in storage and receiving requests from a user for a search. The search preferably comprises a search query that is completed by a user and supplied to a hyper-text transfer protocol daemon (HTTPD) in the system. The HTTPD transfers the request through a common gateway interface (CGI) to an application program which conducts the search. The results of the search are preferably returned through the HTTPD to the computer in the form of a listing of all messages or files satisfying the search parameters. The user may then select one or more of the listed messages or files and may save the search for later references.

BRIEF DESCRIPTION OF THE DRAWINGS

The accompanying drawings, which are incorporated in, and form a part of, the specification, illustrate an embodiment of the present invention and, together with the description, serve to explain the principles of the invention. In the drawings:

FIG. 1 is a block diagram illustrating the connections of a message storage and delivery system MSDS;

FIG. 2 is an overall flow chart of operations for transmitting a message to the MSDS of FIG. 1;

FIG. 3 is an overall flow chart of operations for receiving a message stored at the MSDS of FIG. 1;

FIGS. 4(A) and (B) are flowcharts of operations for generating HTML files according to user preferences;

FIG. 5 is a flowchart of operations for generating requested information;

FIG. 6 is a flowchart of operations for converting a facsimile message into HTML files;

FIG. 7 is an exemplary display of a first page of a facsimile message according to a fourth display option;

FIG. 8 is a flowchart of operations for converting a voice message into an HTML file;

FIG. 9 is a flowchart of operations for converting a data message into an HTML file;

FIG. 10 is a flowchart of operations for detecting a type of call received at the MSDS 10;

FIG. 11 is a flowchart of operations for receiving voice messages;

FIG. 12 is a flowchart of operations for interacting with an owner's call;

FIG. 13 is a more detailed block diagram of the MSDS 10 ;

FIG. 14 is a block diagram of the central processor in FIG. 13;

FIG. 15 is a block diagram of the Internet Server of FIG. 13;

FIGS. 16(A) and 16(B) depict possible software layers for the Internet Server of FIG. 13;

FIG. 17 is a diagram of a data entry for a message signal;

FIG. 18 is a flowchart of a process for sending a search query, for conducting a search, and for returning results of the search to a computer through the Internet;

FIG. 19 is an example of a search query form for defining a desired search;

FIG. 20 is an example of a completed search query;

FIG. 21 is an example of a set of search results returned to the computer in response to the search query of FIG. 20; and FIG. 22 is an example of a listing of stored searches.

DETAILED DESCRIPTION OF THE PREFERRED EMBODIMENTS

Reference will now be made in detail to the preferred embodiments of the invention, examples of which are illustrated in the accompanying drawings.

With reference to FIG. 1, a message storage and delivery system (MSDS) 10 is connected to a central office 20 of the telephone company through at least one direct inward dialing (DID) trunk 15. With each call on the DID trunk 15, an address signal indicating the telephone number being called is provided to the MSDS 10. The DID trunk 15 can carry a large number of telephone numbers or addresses. Preferably, the DID trunk 15 comprises a number of DID trunks 15 connected in parallel between the central office 20 and the MSDS 10 so that the MSDS 10 can simultaneously receive more than one call and, moreover, can simultaneously receive more than one call for a single telephone number or address.

The central office 20 is connected to a number of third parties. For instance, the central office 20 may be connected to a facsimile machine 24, a telephone set 26, and to a computer 28 with each connection being made through a separate telephone line. While a single computer 28 is shown in the figure, the single computer 28 may actually represent a local area network which is connected through the central office 20 to the MSDS 10. Although the facsimile machine 24, telephone set 26, and computer 28 have been shown on separate lines, it should be understood that one or more of these devices could share a single line.

The MSDS 10 is also connected to a network, preferably the Internet World Wide Web 30. Although the Internet 30 has been shown as a single entity, it should be understood that the Internet 30 is actually a conglomeration of computer networks and is a constantly evolving and changing structure. The MSDS 10 therefore is not limited to the current structure or form of the Internet 30 but encompasses any future changes or additions to the Internet 30. Further, the MSDS 10 is shown as being directly connected to the Internet 30, such as through its own node or portal. The MSDS 10, however, may be practiced with any suitable connection to the Internet 30, such as through an intermediate Internet access provider.

With reference to FIG. 2 depicting an overall operation of the invention, a telephone call directed to a number serviced by the MSDS 10 is initiated at step 40 by a third party, for instance, through the facsimile machine 24, telephone set 26, or computer 28. The incoming telephone call may therefore carry a facsimile message, a voice message, or a data message. At step 42, the address signal associated with the initiated call is routed through the central office 20, over the DID trunk 15, and to the MSDS 10.

When the call reaches the MSDS 10, the call is routed (see, e.g., step 44) within the MSDS 10 in a manner that will be described in more detail below with reference to FIG. 13. At step 46, the MSDS 10 answers the telephone call and receives the address signal from the DID trunk 15. Next, at step 48, the call is established between the MSDS 10 and the third party and, at step 50, the MSDS 10 receives the message transmitted over the telephone line. The message is stored at step 52, a database within the MSDS 10 is updated at step 54, and the intended recipient of the message is notified at step 56. The intended recipient of the message uses the services provided

by the MSDS 10 and will hereinafter be referred to as a user. At step 58, the message is converted into hyper-text mark-up language (HTML).

After the MSDS 10 receives a message for one of its users, the user can then communicate with the MSDS 10 at any time and at any location by connecting to the Internet World Wide Web 30 and retrieving the message stored within the MSDS 10. With reference to FIG. 3, at step 60 the user first connects to the Internet 30, such as through a personal computer 32 which may be connected to the Internet 30 in any suitable manner, such as through its own portal or node or through some intermediate access provider. The personal computer 32 is not limited to a single computer but may instead comprise a network of computers, such as a local area network within an office.

Once connected with the Internet 30, at step 62, the user accesses with a hyper-text browser the Universal Resource Locator (URL) associated with his or her MSDS 10 mailbox. The computer 32 may use any suitable hypertext browser, such as Netscape, to access the mailbox. A Hypertext Transfer Protocol Daemon (HTTPD) within the MSDS 10 receives the URL request at step 64 and, at step 66, requests user authentication. The user then supplies his or her ID and password at step 68 and, if found valid at step 70, the MSDS 10 provides the computer 32 with access to the mailbox at step 72. If the ID and password are invalid, as determined at step 70, then the HTTPD sends the computer 32 an authentication failure message at step 74.

After the user gains access to the mailbox at step 72, the user can request information stored within the MSDS 10. The MSDS 10 receives the request at step 76 and, at step 78, determines whether the information exists. As is common practice, the MSDS 10 also determines the validity of the request at step 78. The request from the user will include the mailbox number for the user, the message identifier, display preferences, and, if the message is a facsimile message, a page identifier. If for any reason the request is invalid, such as when a hacker is attempting to gain access to privileged information, the request for the information will be terminated.

If the requested information is available, then at step 80 the information is transmitted through the Internet 30 to the user's computer 32. If, on the other hand, the information does not exist, then at step 82 the MSDS 10 will generate the requested information and then send the information to the user's computer through the Internet 30 at step 80.

Prior to gaining access to the mailbox at step 72, the user is preferably sent a greeting page or other such type of information which permits the user to learn about the services provided by the MSDS 10, open an account with the MSDS 10, or gain access to an account. Once access is provided at step 72, the user is provided with information indicating the total number of messages stored in his or her mailbox within the MSDS 10. Preferably, the information sent by the MSDS 10 indicates the total number of messages for each type of message and also the total number of saved messages versus the total number of new messages.

The user is also preferably given the option at this step to change account information. The account information might include the E-mail address for the user, the manner in which messages are to be reviewed, the user's pager information, as well as other user preferences. The display options and other user preferences will be discussed in further detail below.

The general information HTML file which indicates the total number of different messages is provided with a number of anchors, which are also termed links or references. In general, an anchor permits a user on the computer 32 to

retrieve information located on another file. For instance, an anchor to a listing of facsimile messages is preferably provided on the display of the total number of messages. When the user selects the anchor for the facsimile list, the MSDS 10 pulls up and displays the file containing the list of facsimiles, such as a file "faxlist.html" The other types of messages, such as voice messages and data messages, would have similar anchors on the general information page directed to their respective HTML listing files.

When a new message is received at step 54 in FIG. 2, the users mailbox is updated to display the total number and types of messages. The MSDS 10 might also update other files in addition to the total listing of messages. Additionally, at this time, the MSDS 10 sends an E-mail message to the user's computer 32 to inform the user of the newly arrived message. The MSDS 10 could also send notice to the user through a paging system so that the user receives almost instantaneous notice that a message is received.

The MSDS 10 also generates additional information according to the user's preferences. These preferences on how the MSDS 10 is configured for the user include options on how the messages are reviewed. With facsimile messages, for instance, the user can vary the amount or the type of information that will be supplied with the listing of the facsimile messages by selecting an appropriate option. Other options are also available so that the user can custom fit the MSDS 10 to the users own computer 32 or own personal preferences.

For instance, when a facsimile message is received, the MSDS 10, at step 54, will update the total listing of all messages to indicate the newly received message and may additionally generate the HTML files for the newly received facsimile message according to the users preferences. When the user later requests information on the message at step 76, the HTML information has already been generated and the MSDS 10 may directly send the requested information to the user at step 80. If, on the other hand, the user desires to view the message according to one of the other options, the MSDS 10 will generate the HTML files at step 82 according to that other option at the time of the request.

A first option available to the user for viewing a facsimile message is a textual only listing of the messages. The information on the textual listing preferably includes the date and time that the message was received at the MSDS 10, the telephone number from where the message was transmitted, the number of pages, the page size, and the size of the message in bytes. The messages, of course, could be listed with other yes of information. When the user selects one of the facsimile messages on the list, a request is sent to the HTTPD within the MSDS 10 causing the message to be downloaded via the Internet 30 to the user's computer 32. Once the message is received by the computer 32, the message can be displayed, printed, or saved for further review.

The second through fifth options allow the user to preview an image of the facsimile message before having the message downloaded from the MSDS 10 through the Internet 30 and to the computer 32. The second option permits the user to view the list of messages with a reduced size image of the cover page next to each entry on the list. When the user selects one of the messages on the list, the selected facsimile message is transmitted through the Internet 30 to the computer 32. The user may also scroll through the listings if all of the message cannot be displayed at one time on the computer 32.

The third option provides the user with a full size view of the cover page of each facsimile message The user can quickly scroll through the cover pages of each message without downloading the entire message to the computer 32. The

full size view of the cover pages permit the user to clearly discern any comments that may be placed on the cover page, which may not be possible from just a reduced image of the cover page available through the second option.

The fourth option provides the user with a reduced size image of each page and permits the user to scroll through the entire message. The user can therefore read the entire facsimile message on screen before the message is downloaded onto the computer 32. With this option, the user can go through the pages of the facsimile message and can also skip to the next message or previous message. Additionally, the user has the option of enlarging a page to a full size view of the page. Then one of the messages is selected, as with the other options, the HTTPD within the MSDS 10 causes the facsimile message to be transmitted through the Internet 30 to the user's computer 32.

With a fifth option, a full size image of each page is transmitted to the users computer 32. The user can scroll through the pages of the facsimile message and easily read the contents of each page. If the user wants the message downloaded to the computer 32, the user select the message and the HTTPD within the MSDS 10 transmits the message to the users computer 32 through the Internet 30.

As discussed above, after the database is updated at step 54, the MSDS 10 will generate additional information based upon the option selected for displaying the facsimile messages. More specifically, as shown in FIG. 4(A), if the first option has been selected, as determined at step 100, then at step 102 the MSDS 10 will generate the textual listing of the facsimile messages with anchors or references to the respective facsimile files. The HTML files are then moved to an Internet Server at step 104.

If the first option is not selected, the MSDS 10 next determines whether the second option has been selected at step 106. With the second option, the facsimile messages are listed along with a reduced size image of the cover page. To generate this information, the cover page is extracted from the facsimile file at step 108 and a reduced size HTML image of the cover page is created at step 110. At step 112, a listing of the facsimile messages is generated with a thumbnail view of each cover page linked to its respective facsimile file. The generated HTML files are then sent to the Internet Server at step 104.

When the third option is selected, as determined at step 114, a full size image of the cover page is sent to the computer 32. The full size image of the cover page is generated by first extracting the cover page from the facsimile file at step 116. Next, the cover page is converted into a full size HTML image at step 118 and, at step 120, the listing is generated with the embedded cover page linked to the facsimile file.

If, at step 122, the fourth option is determined to be selected then a reduced size image of each page is provided to the user with the option of enlarging the page to view the contents of the page more clearly. With reference to FIG. 4(B), the information necessary for the third option is produced by first extracting the first page of the facsimile message at step 124. A reduced size HTML image is created at step 126 and then a full size HTML image is created at step 128. At step 130, the listing is generated with embedded thumbnail images of the pages with links to the full size images. If the page is not the last page, as determined at step 140, then the next page is extracted at step 142 and steps 126 to 130 are repeated to generate the HTML files for the other pages of the facsimile message. After the last page has been converted into an HTML file according to the third option, the files are moved onto the Internet Server at step 104.

At step 144, the MSDS 10 determines whether the fifth option has been selected. The fifth option provides the user with a full size image of each page of the facsimile message. While only five options have been discussed, the invention may be practiced with additional options. Consequently, with additional options and with the fourth option not being selected, the MSDS 10 would next determine whether one of the additional options have been selected. With the preferred embodiment of the invention having only five options, however, the MSDS 10 will assume that the fifth option has been selected if none of the first four options were found to be selected.

The information necessary to display the pages of the facsimile message according to the fifth option is generated by first extracting the fit page of the facsimile message at step 146. At step 148, a full size HTML image of the page is created and, at step 150, a listing is generated with an embedded image and links to previous and next pages. When the page is not the last page, as determined at step 152, the MSDS 10 extracts the next page and generates the HTML file for that page. After all pages have been converted into HTML files according to the fourth option, the files are sent to the Internet Server at step 104.

While FIGS. 4(A) and (B) describe the operations of the MSDS 10 at the time a message is received, FIG. 5 depicts an overall flowchart of operations for the MSDS 10 when the user requests a page of information in a display format other than the user's preferred option of displaying the message. FIG. 5 is therefore a more detailed explanation of how the MSDS 10 generates the necessary information at step 82 of FIG. 3.

In general, as shown in FIG. 5, the MSDS 10 first determines the type of image that is needed at step 82a. For example, at this step, the MSDS 10 will determine whether images are unnecessary, whether an image of just the cover page is necessary, whether an image is needed for every page, and whether the image needs to be a full size a reduced size, or both full and reduced sized images. At step 82b, the MSDS 10 determines whether the image has already been created. If the image has not been created, then at step 82c the MSDS 10 will extract the page from the base facsimile file and, at step 82d, generate the required HTML image. As discussed above, the required image may be for just the cover page, for all the pages, and may be a full size and/or a reduced size image of the page. At step 82e, the image is embedded with links or anchors to other HTML files. The links or anchors might be references to the next and previous pages and also to the next and previous facsimile messages. Finally, the HTML file having the embedded image and links is sent to the user at step 80 in FIG. 3.

The process for converting a facsimile message into HTML files according to the fifth option will be described with reference to FIG. 6. This process will occur at step 54 when the message is received and when the fifth option is the users preferred option of displaying the messages. It should be understood that a similar type of process will also occur when the user requests a page of information according to the fifth option when the user is retrieving a facsimile message and the fifth option is not the users preferred option. The conversion processes according to the other options will become apparent to those skilled in the art and will therefore not be discussed in further detail.

With reference to FIG. 6, when the facsimile message is received, the message is in a Tagged Image File Format/Facsimile (TIFF/F) and each page of the facsimile message is split into a separate file. Each page of the facsimile message is then converted from the TIFF/F format into a Portable Pixel

Map (PPM) format. The PPM files are next converted into separate Graphic Interchange Format (GIF) files and then into separate HTML files. Thus, each page of the facsimile message is converted into a separate HTML file. The TIFF/F files may be converted into PPM with an available software package entitled "LIBTIFF" and the PPM files may be converted into GIF files with an available software package found in "Portable Pixel Map Tools."

The invention is not limited to this exact conversion process or to the particular software packages used in the conversion process. For instance, the TIFF/F files may be converted into another portable file format, through any other type of intermediate format, or may be converted directly into the GIF format. Further, instead of GIF, the facsimile messages may be converted into JPEG, BMP, PCX, PIF, PNG, or any other suitable type of file format.

The files may be identified with any suitable filename. In the preferred embodiment, the files for each user are stored in a separate directory assigned to just that one user because an entire directory for a given user generally can be protected easier than the individual files. The memory, however, may be organized in other ways with the files for a single user being stored in different directories. The first part of the filename is a number preferably sequentially determined according to the order in which messages arrive for that user. The preferred naming convention for ending the filenames is depicted in FIG. 6. Each page of the facsimile message is saved as a separate file with an extension defined by the format of the file. Thus, the files will end with an extension of ".TIFF," ".PPM," ".GIF," or ".HTML" according to the format of the particular file. In the example shown, the separate pages have filenames which end with the respective page number, for instance, the first page ends with a "1." The files, however, are preferably terminated with a letter or multiples letters to indicate the order of the pages. For instance, page might have an ending of "aa," page 2 might have an ending of "ab," etc. The invention, however, is not limited to the disclosed naming convention but encompasses other conventions that will be apparent to those skilled in the art.

As shown in FIG. 6, in addition to the GIF files representing the pages of the facsimile message, the HTML files include a number of anchors or references. In the example shown, the first HTML file has an anchor a for the "Next Page." Anchor a is defined as `a=Next Page <a>` and will therefore reference the second HTML file when a user selects the "Next Page." The second HTML file has an anchor b for the "Previous Page" and an anchor c for the "Next Page" and the third HTML file has an anchor d for the "Previous Page." With these particular HTML files, the user can scroll through each page of the facsimile message and view a full size image of the page.

Each HTML file preferably contains anchors in addition to those relating to "Next Page" and "Previous Page." For instance, each HTML file may contain an anchor to the next facsimile message, an anchor to the previous facsimile message, and an anchor to return to the facsimile list. The HTML files preferably contain anchors relating to "Save" and "Delete." When the "Save" anchor is selected, the user would be able to save the message under a more descriptive name for the message. The "Delete" anchor is preferably followed by an inquiry as to whether the user is certain that he or she wants to delete the message. Other anchors, such as an anchor to the general listing, will be apparent to those skilled in the art and may also be provided.

FIG. 7 provides an example of a display according to the fifth option for the first page of the facsimile message shown in FIG. 6. The headings of the display provide information on

13

the telephone number from where the message was sent, the date and time the message was received at the MSDS 10, and an indication of the page of the message being displayed. The main portion of the display is the full site image of the page. At the bottom of the display, an anchor or link is provided to the "Next Page" and another anchor is provided to the "Return to Fax Listing." Additional information may also be provided on the display, such as a link to a company operating the MSDS 10.

An example of the "1.html" file for generating the display shown in FIG. 7 is shown below in Table 1.

TABLE 1

```

<HTML>
<HEAD>
<TITLE>Fax Received on May 31, 1995 at 1:58 PM from (404) 249 6801;
Page 1 of 3</TITLE>
</HEAD>
<BODY>
<H1>Fax from (404) 249-6801</H1>
<H2>Received on May 31, 1995 at 1:58 PM</H2>
<H2>Page 1 of 3</H2>
<IMG SRC="1.gif">
<P>
<A HREF="2.html">Next Page</A>
<HR>
<A HREF="faxlist.html">Return to Fax Listing</A>
<P>
This page was automatically generated by FaxWeb(tm) on May 31, 1995
at 2:05 PM.
<P>
&copy; 1995 NetOffice, Inc.
<HR>
<Address>
<A HREF="http://www.netoffice.com/">NetOffice, Inc.</A><BR>
PO Box 7115<BR>
Atlanta, GA 30357<BR>
<A HREF="mailto:info@netoffice.com">info@netoffice.com</A>
</Address>
</BODY>
</HTML>

```

As is apparent from the listing in Table 1, the image file "1.gif" for the first page is embedded into the HTML file "1.html." Also apparent from the listing is that the anchor for "Next Page" directs the MSDS 10 to the second page of the facsimile message having the filename "2.html" and the anchor for "Return to Fax Listing" directs the MSDS 10 to the filename "faxlist.html" containing the list of facsimile messages.

A process for converting a voice message into an HTML file is illustrated in FIG. 8. The voice message is originally stored in a VOX format or an AD/PCM format and is retrieved at step 170. The voice message is then converted either into an AU format or WAV format in accordance with the user's preference, which is stored in memory. Preferably, the message is in the AD/PCM format originally and is converted in WAV (e.g., as indicated at step 172), but the voice files may alternatively be stored and converted in file formats other than the ones disclosed, such as REALAUDIO® (RA) audio format.

At step 174, the listing of all of the voice messages is then updated to include a listing of the newly received voice message and an anchor to the voice message. For instance, the original voice message may be stored with filename "1.vox" and is converted into WAV and stored with a filename "1.wav." The file "voicelist.html" which contains a list of all voice messages would then have an anchor to the filename "1.wav" along with identifying information for the voice message, such as when the message was received.

14

The listing of the voice messages may have additional anchors or references. For instance, each voice message may have an anchor directing the MSDS 10 to a file which contains a short sampling of the message. Thus, when the user selects this anchor, the user could receive the first 5 seconds of the message or some other predefined number of seconds. As with the listing of facsimile messages, the listing of the voice messages also preferably has anchors to "Save" and "Delete."

FIG. 9 illustrates a process for converting a data message into HTML. At step 180, the data file is retrieved from a database and at step 182 the HTML file containing the list of data messages is updated to include a listing of the newly received message along with identifying information. For instance, the HTML file for the listing "datalist.html" would be updated to include an anchor to a data file "file1.1" and would have information such as the time and date that the data was transmitted, the size of the data file, as well as additional identifying information.

Because the MSDS 10 can receive messages of various types, such as a facsimile message, voice message or data messages the MSDS 10 must be able to determine the type of message that is being sent over the DID trunk 15. With reference to FIG. 10, when an incoming call is received, the MSDS 10 goes off hook at step 200 and starts to generate a ringing sound. If, at step 202, a facsimile calling tone is detected, then the ringing sound is stopped at step 204 and the message is received as a facsimile message at step 206. Similarly, when a data modem calling tone is detected at step 208, the ringing sound is stopped at step 210 and the message is identified as a data message at step 212.

If the MSDS 10 detects a DTMF digit at step 214, the ringing sound is stopped at step 216 and the MSDS 10 then determines which digit was pressed. When the digit is a "1," as determined at step 218, the message is identified as a facsimile message. The MSDS 10 will thereafter receive and store the facsimile message in the manner described above with reference to FIG. 2. If the digit is identified as a "0" at step 220, the call is identified as an owner's call and will be processed in a manner that will be described below with reference to FIG. 12. As will be apparent, other digits may cause the MSDS 10 to take additional steps. If any other DTMF digit is pressed, at step 224 the MSDS 10 activates a voice call system, which will be described in more detail below with reference to FIG. 11.

With step 226, the MSDS 10 will enter a loop continuously checking for a facsimile calling tone, a data modem calling tone, or for a DTMF digit. If after n rings none of these tones or digits has been detected, the ringing sound is stopped at step 228 and the voice call system is activated at step 224.

With reference to FIG. 11, when a fax calling tone or modem calling tone is not detected, the voice call system begins at step 230 by playing a voice greeting. If the greeting was not interrupted by a DTMF digit as determined at step 232, then the caller is prompted for the voice message at step 234 and, at step 236, the voice message is recorded and stored in memory. At step 238, the caller is prompted with a number of options, such as listening to the message, saving the message, or re-recording the message. Since the selection of these options with DTMF digits will be apparent to those skilled in the art the details of this subroutine or subroutines will not be described in further detail. When the caller wishes to re-record the message, as determined at step 240, the caller is again prompted for a message at step 234. If the caller does not wish to re-record the message, the call is terminated at step 242.

If the voice greeting is interrupted by a DTMF digit, as determined at step 232, then the MSDS 10 ascertains which

15

digit has been pressed. At step 244, if the digit is a "0," the MSDS 10 detects that the call is an owner's call. When the digit is a "1," the MSDS 10 is informed at step 206 that the call carries a facsimile message. As discussed above with reference to FIG. 10, other DTMF digits may cause the MSDS 10 to take additional steps. If an invalid digit is pressed, by default at step 248 the routine returns to step 234 of prompting the caller for a message.

It should be understood that the invention is not limited to the specific interactive voice response system described with reference to FIG. 11. As discussed above, the invention may be responsive to DTMF digits other than just a "0" and a "1." Further variations or alterations will be apparent to those skilled in the art.

With reference to FIG. 12, when the call is considered an owner's call, the caller is first prompted for the password at step 250. The password is received at step 252 and, if found correct at step 254, a set of announcements are played to the owner. These announcements would preferably inform the owner of the number of new messages that have been received, the number of saved messages, the number of facsimile message, the number of data messages, and the number of voice messages. Other announcements, of course, could also be made at this time.

At step 258, the owner then receives a recording of the owner's menu with the appropriate DTMF digit for each option. For instance, the 137 digit "1" may be associated with playing a message, the DTMF digit "2" may be associated with an options menu, and the DTMF digit "*" may be associated with returning to a previous menu or terminating the call if no previous menu exists.

A DTMF digit is detected at step 260 and the appropriate action is taken based upon the digit received. Thus, if the digit is determined to be a "1" at step 264, the owner can play a message at step 266. At step 266, the owner is preferably greeted with a menu giving the owner the options of playing or downloading new messages, saved messages, facsimile messages, data messages, or voice messages. As should be apparent to those skilled in the art, the owner may receive one or more menus at step 266 and the owner may enter one or more DTMF digits in order to play or download a particular message.

If, instead, the digit is determined to be a "2" at step 268, then the owner receives an options menu at step 270. With the options menu, the owner can enter or change certain parameters of the MSDS 10. For instance, the owner can change his or her password, the owner can change the manner in which facsimile messages are displayed on the computer 32, the owner can change the image file format from GIF to another format the owner can select the file formats for the voice messages, as well as other options.

If the "*" DTMF digit is received, as determined at step 272, then the owner is returned to a previous menu (see, e.g., step 274). The "*" digit is also used to terminate the call when the owner has returned to the initial menu. The "*" digit is therefore universally recognized by the MSDS 10 throughout the various menus as a command for returning to a previous menu.

If the owner enters a DTMF digit that is not being used by the MSDS 10, the owner receives an indication at step 276 that the key is invalid and the owner is then again provided with the owner's menu at step 258. When the owner does not enter a DTMF digit while the owner's menu is being played, as determined at step 260, the menu will be replayed n times. Once the menu has been replayed n times, as determined at step 262, then the call will be terminated at step 278.

16

If the password is incorrect, as determined at step 254, then the MSDS 10 checks whether the user has made more than "n" attempts at step 280. If "n" attempts have not been made, then a password incorrect message will be displayed to the user at step 282 and the user will once again be prompted for the password at step 250. When the user has made "n" attempts to enter the correct password, the MSDS 10 will play a failure message to the user at step 284 and then terminate the call at step 286. The specific number "n" may be three so that the call is terminated after three failed attempts.

The owner's menu may be responsive to an additional number of DTMF digits and may be structured in other ways. For instance, separate DTMF digits may direct the owner to the respective types of messages, such as a facsimile message, data message, or voice message. Also, separate DTMF digits may direct the owner to a recording of new messages or to a recording of saved messages. Other variations will be apparent to those skilled in the art.

A more detailed diagram of the MSDS 10 is shown in FIG. 13. As shown in the figure, a plurality of DID trunks 15 are received by an input/output device 17 and are then sent to a central processor 3. The number of DID trunks 15 may be changed to any suitable number that would be necessary to accommodate the anticipated number of telephone calls that may be made to the MSDS 10. The input/output device 17 routes a call on one of the DID trunks 15 to an open port of the central processor 3 and is preferably a DID Interface Box manufactured by Exacom.

The central processor 3 receives the calls on the DID trunks 15 and stores the messages in storage 11 in accordance with software 7. Preferably, a separate directory in storage 11 is established for each user having an account on the MSDS 10 so that all of the messages for a single user will be stored in the same directory. It should be understood that the number of processors within the central processor 3 is dependent upon the number of DID trunk 15. With a greater number of DID trunks capable of handling a larger number of telephone calls, the central processor 3 may actually comprise a number of computers. The input/output device 17 would then function to route incoming calls to an available computer within the central processor 3.

A more detailed diagram of the central processor 3 is shown in FIG. 14. The central processor 3 comprises a telephone line interface 21 for each DID trunk 15. The telephone interface 21 provides the ringing sounds and other communication interfacing with the telephone lines. The signals from the telephone interface 21 are routed to a pulse/tone decoder 23 and to a digital signal processor (DSP) 25. The pulse/tone decoder 23 detects the address signal off of an incoming call and sends the address signal onto a bus 29 to a microprocessor 27. The DSP performs the necessary signal processing on the incoming calls and routes the processed signals to the microprocessor 27.

The microprocessor 27 will then read the address signal from the pulse/tone decoder 23 and store the message from the DSP 25 in an appropriate directory in storage 11. As discussed above, the central processor 3 may comprise a number of computers or, more precisely, a number of microprocessors 27 with each microprocessor 27 handling the calls from a certain number, such as four, DID trunks 15. The microprocessor 27 may comprise any suitable microprocessor, but is preferably at least a 486 PC.

In addition to handling incoming calls and storing the messages in storage 11, the central processor 3 also coordinates the interactive voice response system of the MSDS 10. The software 7 would incorporate the flowcharts of operations for receiving a message shown in FIG. 3, for detecting

the type of message on an incoming call shown in FIG. 10, for receiving voice messages shown in FIG. 11, and for receiving an owner's call shown in FIG. 12. Based upon the above-referenced flowcharts and the respective descriptions, the production of the software 7 is within the capability of one of ordinary skill in the art and will not be described in any further detail.

The Internet Server 5 is connected to the central processor 3, such as through a local area network, and also has access to the storage 11. The Internet Server 5 performs a number of functions according to software 9. For instance, the Internet Server 5 retrieves the data files stored in storage 11 by the central computer 3 and converts the files into the appropriate HTML files. The converted HTML files are then stored in storage 11 and may be downloaded to the computer 32 through the Internet 30. The Internet Server 5 also handles the requests from the computer 32, which might require the retrieval of files from the storage 11 and possibly the generation of additional HTML files.

The software 9 for the Internet Server 5 would therefore incorporate the flowchart of operations for generating HTML files according to user preferences shown in FIG. 4, for generating requested information from a user shown in FIG. 5, for converting facsimile messages into shown in FIG. 6, for converting voice messages into HTML shown in FIG. 8, and for converting data messages into HTML shown in FIG. 9. Based upon the above-referenced flowcharts and their respective descriptions, the production of the software 9 is within the capability of one of ordinary skill in the art and need not be described in any further detail.

Nonetheless, a more detailed block diagram of the Internet Server 5 is shown in FIG. 15. The Internet Server 5 runs on a suitable operating system (OS) 39, which is preferably WINDOWS® NT operating system. The Internet Server 5 has a number of application programs 31, such as the ones depicted in the flowcharts discussed above, for communicating with the central processor 3 and for accessing data from storage 11 and also from memory 33.

The memory 33, inter alia, would contain the data indicating the preferences of each user. Thus, for example, when a facsimile message in the TIFF/F format is retrieved by the Internet Server 5, the Internet Server 5 would ascertain from the data in memory 33 the preferred option of displaying the facsimile message and would generate the appropriate HTML files.

All interfacing with the Internet 30 is handled by the HTTPD 37, which, in the preferred embodiment, is "Enterprise Server" from NetScape Communications Corp. Any requests from users, such as a request for a file, would be handled by the HTTPD 37, transferred through the CGI 35, and then received by the application programs 31. The application programs 31 would then take appropriate actions according to the request, such as transferring the requested file through the CGI 35 to the HTTPD 37 and then through the Internet 30 to the users computer 32.

The Internet Server 5 may be connected to a paging system 13. Upon the arrival of a new message, in addition to sending an E-mail message to the user's mailbox, the Internet Server 13 may also activate the paging system 13 so that a pager 15 would be activated. In this manner, the user could receive almost instantaneous notification that a message has arrived.

The paging system 13 is preferably one that transmits alphanumeric characters so that a message may be relayed to the user's pager 15. The Internet Server 5 therefore comprises a signal processor 41 for generating signals recognized by the paging system 13 and a telephone interface 43. The signal processor 4 preferably receives information from the appli-

cation programs 31 and generates a paging message in a paging file format, such as XIO/TAP. The telephone interface 43 would include a modem, an automatic dialer, and other suitable components for communicating with the paging system 13.

The information from the application programs 31 may simply notify the user of a message or may provide more detailed information. For instance, with a facsimile message, the information from the application programs 31 may comprise CSI information identifying the sender's telephone number. The user would therefore receive a message on the pager 15 informing the user that a facsimile message was received from a specified telephone number. The amount and type of information that may be sent to the user on the pager 15 may vary according to the capabilities of the paging system 13 and may provide a greater or lesser amount of information than the examples provided.

The Internet Server 5 is not limited to the structure shown FIG. 15 but may comprise additional components. For instance, the HTTPD 37 would be linked to the Internet 30 through some type of interface, such as a modem or route. The Internet Server 5 may be connected to the Internet 30 through typical phone lines, ISDN lines, a T1 circuit, a T3 circuit, or in other ways with other technologies as will be apparent to those skilled in the art.

Furthermore, the Internet Server 5 need not be connected to the Internet 30 but may be connected to other types of networks. For instance, the Internet Server 5, or more generally the network Server 5, could be connected to a large private network, such as one established for a large corporation. The network Server 5 would operate in the same manner by converting messages into HTML files, receiving requests for information from users on the network, and by transmitting the information to the users.

Also, at least one interface circuit would be located between the Internet Server 5 and the central processor 3 in order to provide communication capabilities between the Internet Server 5 and the central processor 3. This network interface may be provided within both the Internet Server 5 and the central processor 3 or within only one of the Internet Server 5 or central processor 3.

Examples of the Internet Server 5 software layers are shown in FIGS. 16(A) and 16(B), with FIG. 16(A) representing the Internet Server 5 in an asynchronous mode of communication and FIG. 16(B) representing the Internet 5 in a synchronous mode of communication. As shown in the figures, the software 9 for the Internet Server 5 may additionally comprise an Internet Daemon for running the HTTPD 37. The software 9 for the Internet Server 5 would also include TCP/IP or other transport layers. Moreover, while the authentication is provided through the HTTPD 37, the authentication of the user's password and ID may be supplemented or replaced with other ways of authentication.

The term synchronous has been used to refer to a mode of operation for the MSDS 10 in which the all possible HTML files for a message are generated at the time the message is received. The HTML files may be generated by the central processor 3 or by the application programs 31. When a request for information is then later received by the HTTPD 37, the information has already been generated and the HTTPD 37 only needs to retrieve the information from storage 11 and transmit the information to the user's computer 32. With a synchronous mode of operation, the CGI 35 would be unnecessary.

The MSDS 10 preferably operates according to an asynchronous mode of operation. In an asynchronous mode of operation, information requested by the user may not be

available and may have to be generated after the request. The asynchronous mode of operation is preferred since fewer files are generated, thereby reducing the required amount of storage 11. Because the information requested by a user may not be available, some anchors cannot specify the filename, such as "2.html," but will instead contain a command for the file. For instance, an anchor may be defined as <AHREF="/fax-web/users/2496801/viewpage.cgi?FAX_NUM=1&PAGE=1&VIEW_MODE=FULL" used in the previous system in order to provide a smooth transition to die MSDS 10.

With the invention, the MSDS 10 can reliably receive voice, facsimile, and data messages for a plurality of users and can receive more than one message for a user at a single time. The messages are stored by the MSDS 10 and can be retrieved at the user's convenience at any time by connecting to the Internet 30. The Internet World Wide Web 30 is a constantly expanding network that permits the user to retrieve the messages at virtually any location in the world. Since the user only needs to incur a local charge for connecting to the Internet 30, the user can retrieve or review messages at a relatively low cost.

Even for the user's at the office or at home, the MSDS 10 provides a great number of benefits. The user would not need a facsimile machine, voice mail system, or a machine dedicated for receiving data messages. The user also need not worry about losing part of the message or violating the confidential nature of the messages. The user, of course, can still have a facsimile machine and dedicated computer for data messages. The MSDS 10, however, will permit the user to use the telephone company's "call forwarding" feature so that messages may be transferred to the MSDS 10 at the user's convenience, such as when the user is away from the office.

The software 7 and software 9 are not limited to the exact forms of the flowcharts shown but may be varied to suit the particular hardware embodied by the invention. The software may comprise additional processes not shown or may combine one or more of the processes shown into a single process. Further the software 7 and 9 may be executed by a single computer, such as a Silicon Graphics Workstation or may be executed by a larger number of computers.

The facsimile messages preferably undergo signal processing so that the images of the facsimile messages are converted from a two tone black or white image into an image with a varying gray scale. As is known in the art a gray scale image of a facsimile message provides a better image than simply a black or white image of the message. The signal processing may comprise any suitable standard contrast curve method of processing, such as anti-aliasing or a smoothing filter. The signal processing may occur concurrently with the conversion from TIFF/F to GIF and is preferably performed for both full and reduced size images of the facsimile messages.

Furthermore, the user may be provided with a greater or fewer number of options in displaying or retrieving messages. The options are not limited to the exact forms provided but may permit the user to review or retrieve the messages in other formats. The options may also permit a user to join two or messages into a single message, to delete portions of a message, or to otherwise the contents of the messages. Also, the various menus provided to the user over the telephone may have a greater number of options and the MSDS 10 may accept responses that involve more than just a single DTMF digit.

The specific DTMF digits disclosed in the various menus are only examples and, as will be apparent to those skilled in the art, other digits may be used in their place. For instance, a "9" may be used in the place of a "*" in order to exit the menu or to return to a previous menu. Also, the DTMF digits may be changed in accordance with the users personal convention. If the user had a previous voice mail system, the user could customize the commands to correspond with the commands used in the previous system in order to provide a smooth transition to die MSDS 10.

The MSDS 10 may restrict a user to only certain types of messages. For instance, a user may want the MSDS 10 to store only facsimile messages in order to reduce costs of using the MSDS 10. In such a situation, the MSDS 10 would perform an additional step of checking that the type of message received for a user is a type of message that the MSDS 10 is authorized to receive on the user's behalf. When the message is an unauthorized type of message, the MSDS 10 may ignore the message entirely or the MSDS 10 may inform the user that someone attempted to send a message to the MSDS 10.

Moreover, the MSDS 10 has been described as having the central processor 3 for handling incoming calls and the Internet Server 10 for interfacing with the Internet 30. The invention may be practiced in various ways other than with two separate processors. For instance, the central processor 3 and the Internet Server 5 may comprise a single computer or workstation for handling the incoming calls and for interfacing with the Internet 30. The MSDS 10 may convert the messages into files prior to storing the messages. Also, the central processor 3 may communicate with the paging system 13 instead of the Internet Server 5. Additionally, as discussed above, the central processor 3 may comprise a number of microprocessors 27 for handling a large number of DID trunks.

The invention has been described as converting the messages into HTML and transmitting the HTML files over the Internet 30 to the computer 32. The HTML format, however, is only the currently preferred format for exchanging information on the Internet 30 and is actually only one type of a Standard Generalized Mark-Up Language. The invention is therefore not limited to the HTML format but may be practiced with any type of mixed media page layout language that can be used to exchange information on the Internet 30.

SGML is not limited to any specific standard but encompasses numerous dialects and variations in languages. One example of an SGML dialect is virtual reality mark-up language (VRML) which is used to deliver three dimensional images through the Internet. As another example, the computer 32 for accessing the MSDS 10 through the Internet 30 may comprise a handheld device. A handheld device is generally characterized by a small display size, limited input capabilities, limited bandwidth, and limited resources, such as limited amount of memory, processing power, or permanent storage, in view of these limited capabilities, a handheld device markup language (HDML) has been proposed to provide easy access to the Internet 30 for handheld devices. The SGML information transmitted by the MSDS 10 to the computer 32 may therefore comprise HDML information suitable for a handheld device or may comprise VRML.

As another example, Extensible Mark-Up Language (XML) is an abbreviated version of SGML, which makes it easier to define document types and makes it easier for programmers to write programs to handle them. XML omits some more complex and some less-used parts of the standard SGML in return for the benefits of being easier to write applications for, easier to understand, and more suited to delivery and inter-operability over the Web. Because XML is

nonetheless a dialect of SGML, the MSDS 10 therefore encompasses the translation of facsimile, voice, and data messages into XML, including all of its dialects and variations, and the delivery of these messages to computers 32 through the Internet 30.

As a further example, the MSDS 10 encompasses the use of "dynamic HTML." "Dynamic HTML" is a term that has been used to describe the combination of HTML, style sheets, and scripts that allows documents to be animated. The Document Object Model (DOM) is a platform-neutral and language neutral interface allowing dynamic access and updating of content, structure, and style of documents. The MSDS 10 may therefore include the use of the DOM and dynamic HTML to deliver dynamic content to the computer 32 through the Internet 30.

The MSDS 10 is also not limited to any particular version or standard of HTTP and thus not to any particular hyper-text transfer protocol deamon 37. In general, HTTP is a data access protocol run over TCP and is the basis of the World Wide Web. HTTP began as a generic request-response protocol, designed to accommodate a variety of applications ranging from document exchange and management to searching and forms processing. Through the development of HTP, the request for extensions and new features to HTTP has exploded; such extensions range from caching, distributed authoring and content negotiation to various remote procedure call mechanisms. By not having a modularized architecture, the price of new features has been an overly complex and incomprehensible protocol. For instance, a Protocol Extension Protocol (PEP) is an extension mechanism for HTTP designed to address the tension between private agreement and public specification and to accommodate extension of HTTP clients and servers by software components. Multiplexing Protocol (MUX) is another extension that introduces asynchronous messaging support at a layer below HTTP. As a result of these drawbacks of HTTP, a new version of HTTP, namely HTTP-NG has been proposed and its purpose is to provide a new architecture for the HTTP protocol based on a simple, extensible distributed object-oriented model. HTTP-NG, for instance, provides support for commercial transactions including enhanced security and support for on-line payments. Another version of HTTP, namely S-HTTP, provides secure messaging. The MSDS 10 and the HTTPD 37 may incorporate these versions or other versions of HTTP.

In addition to different versions of HTTP, the HTTPD 37 of the MSDS 10 may operate with other implementations of HTTP. For instance, the W3C's has an implementation of HTTP called "jigsaw." Jigsaw is an HTTP server entirely written in JAVA® programming language and provides benefits in terms of portability, extensibility, and efficiency. The MSDS 10 may employ Jigsaw or other implementations of HTTP.

With regard to the transmission of messages to the user's computer 32, the MSDS 10 permits the user to sample the voice message or to preview the facsimile message without requiring the MSDS 10 to transmit the entire message to the computer 32. This sampling ability is a significant benefit since the transmission of the entire message would frequently tie up the computer 32 for a rather long period of time. Thus, with the preview or sample feature, the user can determine whether the user needs the message transmitted to the computer 32.

If the user does decide that the entire message needs to be transmitted, as stated above, the user's computer 32 might be receiving the message for a relatively long period of time. After the entire message has been received, the user then has the options of viewing, listening, retrieving, or saving the

message. As an alternative, the user's computer may instead indicate the contents of the message to the user as the message is being received.

For instance, with a voice message, the user's computer 32 could send the message to an audio speaker as the message is being received. In this manner, the message would be played in real time and the user would not need to wait until the entire message is received before listening to the message. In order to play the messages in real time, the messages are preferably in the REALAUDIO® (RA) audio format, which the user can select as a preferred file format for voice messages.

In operation, the MSDS 10 would transmit an HTML file containing an RA file. If the user selects the RA file with the browser on the computer 32, the browser will activate a program for use with RA files. The operations and functioning of this program will be apparent to those skilled in the art and will be available as a separate software package or will be incorporated within a browser program. The RA program will request the RA data file containing the message from the MSDS 10 and, as the RA file is being received at the computer 32, this program will play the message in real time.

The MSDS 10 and the users computer 32 could also be arranged so that each page or even line of a facsimile message could be displayed as the computer 32 receives the facsimile message. Further, although the transmission of a data message is relatively fast in comparison to a voice or facsimile message, the computer 32 could also be programmed to permit access to the data message as the message is being received.

The invention has been described as storing and transmitting voice messages. It should be understood that the voice message would probably be the most often type of audio message stored at the MSDS 10. The invention, however, may be used with any type of audio message and is in no way limited to just voice messages.

According to another aspect of the invention, the MSDS 10 may be used as a file repository serving as an archive for a particular user or group of users. As described above, the MSDS 10 may maintain a list of all messages for a particular user which is displayed to the user when the user access his or her mailbox. The MSDS 10 may store all messages, whether they are voice, facsimile, or data, for a user in the database indefinitely. The MSDS 10 may therefore be relied upon by a user to establish the authenticity of a message and the existence or absence of a particular message. Through the MSDS 10, a user can therefore maintain an accurate record of all received email messages, facsimile messages, and data transfers.

In addition to serving as a file depository, the MSDS 10 may also function as a document management tool. As described above with reference to FIG. 2, when the MSDS 10 receives a message, the MSDS 10 updates a database with information on the message. This information includes the type of message, whether it is a facsimile message, voice message, or data message, the time and date at which the message was received, the size of the file, such as in bytes, the telephone number of the caller leaving the message, as well as other information, such as the number of pages of a facsimile message. Because the telephone number called is unique for each user, the information also includes the intended recipient of the message.

An example of a data entry 300 in storage 11 for a message is shown in FIG. 17. The data entry 300 represents the entry for just a single message with each message having a separate data entry 300. Preferably, the data entries 300 are stored in a relational database and may be searched through a structured query language (SQL).

As shown in FIG. 17, the data field 300 for a message may comprise numerous data fields for describing the message. One of these data fields may comprise a field 301 for indicating the name of the person receiving the message. As will be appreciated by those skilled in the art, the person may be identified in numerous ways, such as by a portion of the person's name or by a unique number. Another field 302 in the data entry 300 indicates the type of the document, such as whether the document is a facsimile message, voice message, or data transfer, and fields 303 and 304 respectively indicate the date and time that the message was received by the MSDS 10. The telephone number of the caller is indicated in field 305 while the size of the message, which may be measured in bytes, is indicated in field 306 and the number of pages of the message is indicated in field 307. A document number for uniquely identifying the message is indicated in field 308. As discussed above, the files or messages received for a particular user may be numbered sequentially in the order that they are received by the MSDS 10. The files and messages, however, may be numbered or identified in other ways, such as by a combination of numbers with an identifier for the date when the message was received. Also, the documents number or identifier may be unique for each file or message directed to a user or, alternatively, may be unique for each file or message directed to a plurality of users, which is advantageous when the MSDS 10 tracks documents for an entire company or other group of users.

In addition to fields 301 to 308, the data entry 300 for a message or file may have other fields 309 for describing or documenting the message or file. The other fields 309, for instance, may be used to identify the type of storage that a message should receive. The messages or files may have different lengths of time that the message is stored before being automatically deleted. The type of storage, such as whether the full text of the message is stored, may also be indicated by field 309. Another example of a trait that may be contained within the other field 309 is security. At times, a user may desire and may be granted access to another person's mailbox, such when the MSDS 10 tracks documents for an entire company. By designating a message or file as secure in field 309, a user may restrict or deny access to that message or file by other users. The other fields 309 may also be used by a user to customize the MSDS 10 according to his or her own desires. For instance, if the user is a company, the company may want to classify messages according to the division at which the message is directed, such as one code for marketing, one for sales, one for engineering, and one for legal.

As another example of a use of one of the other fields 309, a user can input notes in the other field 309. When a user initially receives a data entry 300, the entry 300, for instance, may include data in all fields 301 to 308 except field 309, which has been left blank. The user can then input his or her notes in the other field. An initial data entry 300 may include the field 305 for the caller's telephone number which contains the digits for the calling number. The user, however, may not readily recognize the caller from just reading the telephone number listed in field 305. To more clearly indicate the caller, the user may input notes in field 309 to identify the caller's name. Alternatively, the notes in field 309 may reflect part or all of the contents of the message. The user may receive a large document or message and may input a brief description of the document or message in the field 309. As another example, the recipient of the message may read the message or document and discover that the caller is requesting some service or goods from the recipient, such as a request for certain documents or delivery of a certain quantity of goods. The recipient may read the document or message and place

some notes in the field 309 to indicate the type of follow-up service or action that needs to be taken. An assistant to the recipient can then view the notes in field 309 and take appropriate steps to ensure that the requested service or goods are delivered. If the data entry is security protected, one of the other fields 309, as discussed above, may grant the assistant limited access to just the field 309 or may grant more expansive access whereby the assistant can view fields 301 to 309 as well as the actual document or message. The fields 309 may serve various other purposes, as will be apparent to those skilled in the art.

FIG. 18 illustrates a process 320 for using the MSDS 10 for document management purposes. With reference to FIG. 18, a user sends a search request to the MSDS 10 for a particular document or set of documents at step 321. The user may issue this request with the computer 32 by clicking on a link, such as a link to "Search Documents," which may be presented to the user by the MSDS 10 after the user has been granted accesses to his or her mailbox at step 72 shown in FIG. 3. The MSDS 10 may present the user with the option to search the document archives at other times, such as when the user first attempts to access the mailbox at step 62, or when the URL received by the HTTPD 37 from computer 32 points toward the document archives.

In response to this request the HTTPD 37 sends the user a search query form at step 322 to allow the user to define a desired search. An example of a search query form is shown in FIG. 19. The search query form may include an entry for each of the data fields 301 to 309 in the data entry 300. For instance, the user may input one or more names for a recipient and have the MSDS to search for all messages or files directed to just those recipients. The user may also indicate the type of document, such as whether it is a facsimile, voice message or data file. The search query form also has entries for the date or time, which preferably accept ranges of times and dates, and an entry for the telephone number of the caller to the MSDS 10. The search query form may also include an entry for the size of the file or for the number of pages, which is relevant if the message is a facsimile message. The search query form may also include an entry for the document number, which may accept a range of document numbers, and also an entry for another field.

At step 323, the user enters the search parameters in the search query form with computer 32 and returns the information to the MSDS 10 through the Internet 30. The user may define the search about any one data field or may define the search about a combination of two or more data fields. For instance, as reflected in the completed search query form shown in FIG. 20, a user may define a search by designating the document type as a facsimile and the calling number as (404)249-6801. Once the user has finished defining the search, the user then selects the "SEARCH" link shown at the bottom of the screen whereby the user's computer 32 would send the completed search query form through the Internet 30 to the HTTPD 37 of the MSDS 10.

At step 324, the HTTPD 37 receives the completed search query form and, through CGI 35, invokes one or more of the application programs 31 for performing the desired search for any files or messages falling within the parameters of the search. The results of the search are passed from the application programs 31 through the CGI 35 to the HTTPD 37 and, at step 325, are returned to the user through the Internet 37. Preferably, the MSDS 10 returns the search results. In the form of a listing of all files or messages contained within the search parameters, although the MSDS 10 may return the results in other ways.

An example of the search results of the query shown in FIG. 20 is shown in FIG. 21. As discussed above, the parameters of the search were all facsimile messages from telephone number (404)249-6081. With reference to FIG. 21, this query resulted in three messages being discovered. The first document has a document number 11 and is described as being a facsimile from the designated telephone number to Jane Doe on May 31, 1995, and consists of three pages. This first-listed document is an example of the facsimile shown in FIG. 9. The other two documents respectively correspond to document numbers 243 and 1,002 and are also from the designated telephone number.

At step 326, the user selects the desired file or message from the listing of messages and files. For instance, by clicking on the first listed document, namely document number 11, the computer 32 sends a request to the MSDS 10 for a viewing of that document and, in response, the MSDS 10 provides a viewing of the document according to the user defined preferences. As described above, the user may receive a reduced size image of the first page, a full size image of the first page, reduced size images of all pages, or full size images of all pages of the facsimile message. Thus, if the user selected the fourth display option as the user defined preference, the MSDS 10 would return an image of the first page of the facsimile, such as the one depicted in FIG. 7.

At step 326, the user may also have the MSDS 10 save the search result. For instance, as shown in FIG. 21, the user may input the name of "CHARLES R. BOBO FACSIMILES" as the name for the search. By clicking on the "SAVE SEARCH AS" link, the name of the search is provided from the computer 32 to the MSDS 10. At the MSDS 10, the HTTPD 37 transfers the information from the computer 32 to the CGI 35 and the CGI 35 invokes an application program 31 to store the results of the search in storage 11 under the designated name. The invoked application program 31 preferably does not store the contents of all messages but rather stores a listing of the search results in the storage 11.

The results of a search may be stored in storage 11 as either a closed search or an open search. If the MSDS 10 saves the results of a search as an open search, then the files or messages in that named search may be updated with recent files or messages falling within the particular search parameters for the search. On the other hand, a closed search is one in which the files or messages in the named search are limited to those existing at the time of the search. For example, if the MSDS 10 saved the search results shown in FIG. 21 as a closed search, then any retrieval of the "CHARLES R. BOBO FACSIMILES" would result in only the three listed documents. If, on the other hand, the search named as the "CHARLES R. BOBO FACSIMILES," was saved by the MSDS 10 as an open search, then the MSDS 10 would reactivate the search query shown in FIG. 20 in response to a request by the computer 32 for that search in order to obtain all facsimile messages from that particular telephone number, including those received after the initial saving of the search results.

With reference to FIG. 19, rather than defining a new search, the user may click on the "STORED SEARCHES" link in order to receive the results of a previously performed search. For example, by clicking on this link, the MSDS 10 may return a listing of searches stored for that particular user, such as the searches shown in FIG. 22. As shown in this figure, the "CHARLES R. BOBO FACSIMILES" is included within the list of stored searches. If the user then selected the "CHARLES R. BOBO FACSIMILES" search, the user may then be presented with the listing of facsimiles shown in FIG. 21, possibly including recent additions to the search group.

With reference to FIG. 19, the MSDS 10 may also provide a user with a link to "RECENT FILES" at step 322. By selecting this link, the MSDS 10 may return a listing of all facsimile, voice, and data messages received with a particular period of time, such as the last month. By placing the "RECENT FILES" link on the search query form rather than in the listing of "STORED SEARCHES," the user can quickly turn to the most recent files and messages. The search query form may contain other such easy-access links, such as a link to the last search performed by the MSDS 10 on behalf of the user.

The messages or files received by the MSDS 10 need not arrive from a third party. In other words, the MSDS 10 may be used as a file repository or as a file manager for documents generated by the user itself. The user may call the designated telephone number for receiving messages and transmit voice messages, data messages, or facsimile messages and have the MSDS 10 document the receipt and content of these messages. A user may easily use a facsimile machine as a scanner for entering documents into the storage 11 of the MSDS 10.

The MSDS 10 may have applications in addition to those discussed-above with regard to serving as a message deliverer, file repository, and file manager. For instance, the MSDS 10 may perform some additional processing on the incoming calls prior to forwarding them to the user. For voice messages, this processing may involve transcribing the message and then returning the transcribed messages to the user. The MSDS 10 may therefore be viewed as offering secretarial assistance which may be invaluable to small companies or individuals who cannot afford a secretary or even to larger businesses who may need some over-flow assistance. The transcription may be provided by individuals located in any part of the world or may be performed automatically by a speech-to-text recognition software, such as VoiceType from IBM.

Another type of processing that the MSDS 10 may provide is translation services. The incoming call, whether it is a voice, facsimile, or data message, can be converted into SGML and then forwarded first to a translator. Given the reach of the Internet the translator may be located virtually anywhere in the world and can return the translated document via the Internet to the MSDS 10. The MSDS 10 can notify the user that the translation has been completed through email, voice mail, pager, facsimile, or in other ways. The user would then connect to the Internet and retrieve the translated document. The translation services of the MSDS 10 may also provide transcription of the message, such as with speech-to-text recognition software.

The foregoing description of the preferred embodiments of the invention have been presented only for the purposes of illustration and description. It is not intended to be exhaustive or to limit the invention to the precise form disclosed. Many modifications and variations are possible in light of the above teaching.

The embodiments were chosen and described in order to explain the principles of the invention and their practical application so as to enable others skilled in the art to utilize the invention and various embodiments and with various modifications as are suited to the particular use contemplated. It is intended that the scope of the invention only be limited by the claims appended hereto.

What is claimed is:

1. A method for storing a mark-up language file and delivering the mark-up language file and delivering the mark-up language file from a network server to a user's computer via a packet switched data network using a hyper-text transfer protocol (HTTP), comprising:

27

generating the mark-up language file to include a sequence of mark-up language instructions that cause an application program executing on the user's computer to generate a user interface that provides a link to a message stored in a user-specific message storage area accessible by the network server, and that further provides information personal to the user;

storing the mark-up language file in a storage area accessible by the network server;

transmitting a notification to the user's computer, wherein the notifications serves to notify the user of the availability of the mark-up language file; and

in response to a user request made in response to the notification, transmitting the mark-up language file from the network server to the user's computer, via the packet switched data network, using the hyper-text transfer protocol.

2. The method as set forth in claim 1, wherein the mark-up language file is customized according to one or more user-selected preferences received by the network server from the user's computer.

3. The method as set forth in claim 1, wherein the information personal to the user contained in the mark-up language file comprises information pertaining to one or more messages directed to the user as an intended recipient.

4. The method as set forth in claim 3, wherein the one or more messages comprise voice mail messages.

5. The method as set forth in claim 3, wherein the one or more messages comprise facsimile messages.

6. The method as set forth in claim 3, wherein the one or more messages comprise data messages.

7. The method as set forth in claim 1, wherein the notification comprises an e-mail message.

8. The method as set forth in claim 7, wherein the e-mail message contains information regarding the content of the mark-up language file.

9. The method as set forth in claim 1, wherein the notification contains information regarding the content of the mark-up language file.

10. The method as set forth in claim 1, wherein the notification contains information that enables the user to gain access to the mark-up language file.

11. The method as set forth in claim 1, wherein the packet switched data network comprises the Internet.

12. The method as set forth in claim 1, wherein the mark-up language file comprises an HTML file.

13. The method as set forth in claim 1, wherein the mark-up language file comprises an HTML file personalized according to one or more user-selected preferences received by the network server from the user's computer.

14. The method as set forth in claim 1, wherein the packet switched data network comprises a private network.

15. The method as set forth in claim 1, wherein the user's computer comprises a personal computer that includes a display and a keyboard.

16. The method as set forth in claim 1, wherein the user's computer comprises a handheld device.

17. The method as set forth in claim 1, wherein the application program comprises a hyper-text browser which displays at least part of the content of the mark-up language file in accordance with the sequence of mark-up language instructions.

18. The method as set forth in claim 1, wherein a location of the mark-up language file in the storage area is identified by a URL.

28

19. The method as set forth in claim 18, wherein the application program enables the user to download the mark-up language file using the URL.

20. The method as set forth in claim 19, wherein the application program comprises a browser.

21. The method as set forth in claim 19, wherein the application program comprises a hyper-text browser.

22. The method as set forth in claim 18, wherein the application program comprises a hyper-text browser.

23. The method as set forth in claim 1, wherein the mark-up language file conforms with a dialect of a standardized generalized mark-up language (SGML).

24. The method as set forth in claim 1, wherein the mark-up language file comprises a standardized generalized mark-up language (SGML) file.

25. The method as set forth in claim 1, wherein the network server executes an HTTP daemon (HTTPD) which performs the transmitting.

26. The method as set forth in claim 1, wherein the network server executes an HTTP daemon (HTTPD) which handles HTTP interactions between the network server and the user's computer.

27. The method as set forth in claim 1, wherein: the network server executes an HTTP daemon (HTTPD); the application program is a browser; and wherein the HTTPD performs the transmitting by transmitting the mark-up language file to the browser, using the HTTP.

28. The method as set forth in claim 27, wherein the browser comprises a hyper-text browser.

29. The method as set forth in claim 1, wherein the network server executes an additional application program and an HTTP daemon (HTTPD), and wherein the HTTPD performs the transmitting and processing of user access requests.

30. The method as set forth in claim 29, wherein the application program executing on the user's computer is a hyper-text browser, and the HTTPD performs the transmitting by transmitting the mark-up language file to the hyper-text browser, using the HTTP.

31. The method as set forth in claim 30, wherein the HTTPD establishes an HTTP application layer session between the additional application program executing on the network server and the hyper-text browser executing on the user's computer.

32. The method as set forth in claim 1, wherein the network server comprises an HTTP server and the user's computer comprises an HTTP client.

33. The method as set forth in claim 1, wherein the notification comprises a wireless notification.

34. The method as set forth in claim 1, wherein the mark-up language file includes new information that has only become available subsequent to a prior notification.

35. The method as set forth in claim 1, wherein the mark-up language file includes a reduced size image that the user can select to produce a full-size image.

36. The method as set forth in claim 1, wherein the mark-up language file includes both graphical and textual information.

37. The method as set forth in claim 1, wherein the user interface is customized according to one or more user-selected preferences according to commands contained in the mark-up language file.

38. The method as set forth in claim 1, further comprising varying the amount of information contained in the mark-up language file according to one or more user-selected preferences received by the network server from the user's computer.

39. The method as set forth in claim 1, wherein the user-specific message storage area comprises a user-specific message mailbox within a messaging system comprising a plurality of message mailboxes for a respective plurality of users.

40. The method as set forth in claim 1, wherein the message comprises an HTML message.

41. The method as set forth in claim 40, wherein the HTML message comprises a data message encoded in HTML.

42. The method as set forth in claim 40, wherein the HTML message comprises a voice mail message encoded in HTML.

43. The method as set forth in claim 40, wherein the HTML message comprises a fax mail message encoded in HTML.

44. The method as set forth in claim 1, wherein the user-specific message storage area comprises a user-specific message mailbox within a searchable messaging database comprising a plurality of message mailboxes for a respective plurality of users.

45. The method as set forth in claim 1, wherein the message is received by the network server in a first file format other than a mark-up language file format, and further comprising converting the first file format to the mark-up language file format.

46. The method as set forth in claim 1, wherein:

the user request comprises an access request received from the user's computer by the network server, via the packet switched data network, using the hyper-text transfer protocol,

the access request is indicative of a request by the user to gain access to the user-specific message storage area, the network server making a determination to grant or deny the access request, and

in response to a determination to grant the access request, the network server transmitting the mark-up language file to the user's computer, via the packet switched data network, using the hyper-text transfer protocol.

47. The method as set forth in claim 46, wherein the application program executing on the user's computer comprises a hyper-text browser.

48. The method as set forth in claim 47, wherein the hyper-text browser generates the access request.

49. The method as set forth in claim 46, wherein the access request includes authentication information that enables the network server to authenticate the user as being authorized to access the user-specific message storage area.

50. The method as set forth in claim 49, wherein the authentication information is entered into the user's computer and transmitted to the network server.

51. The method as set forth in claim 49, wherein the authentication information includes a user-specific name.

52. The method as set forth in claim 49, wherein the authentication information includes a user-specific password.

53. The method as set forth in claim 49, wherein the authentication information includes a user-specific name and a user-specific password.

54. The method as set forth in claim 53, wherein the application program executing on the user's computer comprises a hyper-text browser that generates the access request, including the authentication information.

55. The method as set forth in claim 54, wherein the hyper-text browser comprises a web browser.

56. The method as set forth in claim 54, wherein the packet switched data network comprises the Internet.

57. The method as set forth in claim 1, wherein the user interface provides additional links to other messages stored in the user-specific storage area.

58. The method as set forth in claim 57, wherein the message and the additional messages are each addressed to the user.

59. The method as set forth in claim 58, wherein the user interface further provides an indication of a total number of new messages stored in the user-specific storage area.

60. The method as set forth in claim 59, wherein the user interface enables the user to browse through a plurality of messages stored in the user-specific storage area, including the message and the additional messages.

61. The method as set forth in claim 60, wherein the packet switched data network comprises the Internet.

62. The method as set forth in claim 60, wherein the user interface provides icons or text designations to allow the user to browse through messages stored in the user-specific message storage area in sequence.

63. The method as set forth in claim 62, wherein the sequence of browsing can be to prior or subsequent messages relative to a currently displayed or highlighted message.

64. The method as set forth in claim 58, wherein the user interface further provides an indication of a total number of messages stored in the user-specific storage area.

65. The method as set forth in claim 57, wherein the user interface enables access to one or more search fields.

66. The method as set forth in claim 65, wherein: the user interface enables the user to enter data into the one or more search fields;

the user interface enables the user to issue a search request to search the messages stored in the user-specific message storage area based on data entered by the user into the one or more search fields, and the search request is subsequently received by the network server from the user's computer.

67. The method as set forth in claim 66, wherein: in response to the search request, the network server returns a dynamically generated mark-up language file to the user's computer,

the content of the dynamically generated mark-up language file is based at least in part on results of the search request, and

the dynamically generated mark-up language file is enabled to be displayed to the user on the user's computer via the application program after it is received from the network server in an updated instance of the user interface.

68. The method as set forth in claim 67, wherein the updated instance of the user interface also provides links to one or more messages stored in the user-specific message storage area accessible by the network server, and the links to the one or more messages are generated as a result of the search request.

69. The method as set forth in claim 68, wherein the user is enabled to additionally select, at the time of the search request submission, to save the search request for future resubmission to the network server.

70. The method as set forth in claim 69, wherein: the user is enabled to assign a custom name to the saved search,

the custom name is enabled to be subsequently displayed to the user during an update of the user interface, and the custom name is enabled to be selected to initiate a resubmission of the search request to the network server.

71. The method as set forth in claim 70, wherein the resubmission of a saved search request is enabled to be manually requested by the user via the user interface or a subsequently updated instance of the user interface.

31

72. The method as set forth in claim 68, wherein the user may additionally select, upon viewing the results of the search request, to save the search request for future resubmission to the network server.

73. The method as set forth in claim 72, wherein:
the user is enabled to assign a custom name to the saved search,
the custom name is enabled to be subsequently displayed to the user during an update of the user interface, and
the custom name is enabled to be selected to initiate a resubmission of the search request to the network server.
a subsequently updated instance of the user interface.

74. The method as set forth in claim 73, wherein the resubmission of a saved search request is enabled to be manually requested by the user via the user interface or

75. The method as set forth in claim 57, wherein the user is enabled to request a message from the network server by selecting the link for that message.

76. The method as set forth in claim 75, wherein contents of the message requested by the user are embodied in a mark-up language.

77. The method as set forth in claim 76, wherein the contents of the message requested by the user are dynamically generated by the network server upon the receipt by the network server of the request for the message.

78. The method as set forth in claim 75, further comprising generating at least a portion of a content of the message as a result of a translation performed subsequent to the receipt by the network server of data intended for the user.

79. The method as set forth in claim 78, wherein the translation is performed on the network server.

80. The method as set forth in claim 78, wherein the translation is performed on a server remote to the network server.

81. The method as set forth in claim 78, wherein at least a portion of the data received at the network server that is intended for the user is in the form of audio information and the translation is a voice-to-text transcription.

82. The method as set forth in claim 78, wherein at least a portion of the data received at the network server that is intended for the user is in the form of facsimile information and the translation is a facsimile-to text-conversion.

83. The method as set forth in claim 78, wherein at least a portion of the data received at the network server that is intended for the user is in the form of text information in one linguistic form and the translation comprises translating the original linguistic form to another linguistic form.

84. The method as set forth in claim 57, wherein the user interface enables one or more additional message control functions.

85. The method as set forth in claim 84, wherein a particular one of the one or more message control functions allows a user to save one or more messages stored in the user-specific message storage area.

86. The method as set forth in claim 85, wherein a particular one of the one or more message control functions allows a user to delete one or more messages stored in the user-specific message storage area.

87. The method as set forth in claim 57, wherein messages stored in the user-specific message storage area may be stored there indefinitely.

88. The method as set forth in claim 1, wherein the message is addressed to the user.

89. The method as set forth in claim 1, wherein the message is a confidential message addressed to the user and intended to be viewed by only the user.

32

90. A method for storing and delivering a mark-up language file from a network server to a user's client device via a packet switched data network using an Internet protocol, comprising:

generating the mark-up language file to include a sequence of mark-up language instructions that cause an application program executing on the user's client device to generate a user interface that provides a link to a message stored in a user-specific message storage area accessible by the network server, and that further provides information personal to the user;

storing the mark-up language file in a storage area accessible by the network server;

transmitting a notification to the user's client device, the notification serving to notify the user of the availability of the mark-up language file; and

in response to a request received from the user's client device via the packet switched data network, transmitting the mark-up language file from the network server to the user's client device, via the packet switched data network, using the Internet protocol;

wherein the request is generated in the user's client device in response to a user action performed after the notification is received at the user's client device.

91. The method as set forth in claim 90, wherein the mark-up language file is customized according to one or more user-selected preferences received by the network server from the user's client device.

92. The method as set forth in claim 90, wherein the user-specific information contained in the mark-up language file comprises information pertaining to one or more messages directed to the user as an intended recipient.

93. The method as set forth in claim 92, wherein the one or more messages comprise voice mail messages.

94. The method as set forth in claim 92, wherein the one or more messages comprise facsimile messages.

95. The method as set forth in claim 92, wherein the one or more messages comprise data messages.

96. The method as set forth in claim 90, wherein the notification comprises an e-mail message.

97. The method as set forth in claim 96, wherein the e-mail message contains information regarding the content of the mark-up language file.

98. The method as set forth in claim 90, wherein the notification contains information regarding the content of the mark-up language file.

99. The method as set forth in claim 90, wherein the notification contains information that enables the user to gain access to the mark-up language file.

100. The method as set forth in claim 90, wherein the packet switched data network comprises the Internet.

101. The method as set forth in claim 90, wherein the mark-up language file comprises an HTML file.

102. The method as set forth in claim 90, wherein the mark-up language file comprises a web page personalized according to one or more user-selected preferences received by the network server from the user's client device.

103. The method as set forth in claim 90, wherein the packet switched data network comprises a private network.

104. The method as set forth in claim 90, wherein the user's client device comprises a personal computer that includes a display and a keyboard.

105. The method as set forth in claim 90, wherein the user's client device comprises a handheld device.

106. The method as set forth in claim 90, wherein the application program comprises a hyper-text browser which

displays at least part of the content of the mark-up language file in accordance with the sequence of mark-up language instructions.

107. The method as set forth in claim 90, wherein a location of the mark-up language file in the storage area is identified by a URL.

108. The method as set forth in claim 107, wherein the application program enables the user to download the mark-up language file using the URL.

109. The method as set forth in claim 108, wherein the application program comprises a browser.

110. The method as set forth in claim 108, wherein the application program comprises a hyper-text browser.

111. The method as set forth in claim 108, wherein the application program comprises a web browser.

112. The method as set forth in claim 90, wherein the mark-up language file conforms with a dialect of a standardized generalized mark-up language (SGML).

113. The method as set forth in claim 90, wherein the mark-up language file comprises a standardized generalized mark-up language (SGML) file.

114. The method as set forth in claim 90, wherein the network server executes an HTTP daemon (HTTPD) which performs the transmitting.

115. The method as set forth in claim 90, wherein the Internet protocol comprises a hyper-text transfer protocol (HTTP), and wherein the network server executes an HTTP daemon (HTTPD) which handles HTTP interactions between the network server and the user's client device.

116. The method as set forth in claim 90, wherein:
the Internet protocol comprises a hyper-text transfer protocol (HTTP);
the network server executes an HTTP daemon (HTTPD);
the application program is a browser; and
wherein the HTTPD performs the transmitting by transmitting the mark-up language file to the browser, using the HTTP.

117. The method as set forth in claim 116, wherein the browser comprises a hyper-text browser.

118. The method as set forth in claim 90, wherein the network server executes an additional application program and an HTTP daemon (HTTPD), and wherein the HTTPD performs the transmitting and processing of user access requests.

119. The method as set forth in claim 118, wherein the Internet protocol comprises a hyper-text transfer protocol (HTTP), the application program executing on the user's client device is a hyper-text browser, and the HTTPD performs the transmitting by transmitting the mark-up language file to the hyper-text browser, using the HTTP.

120. The method as set forth in claim 119, wherein the HTTPD establishes an HTTP application layer session between the additional application program executing on the network server and the hyper-text browser executing on the user's client device.

121. The method as set forth in claim 90, wherein the network server comprises an HTTP server and the user's client device comprises an HTTP client.

122. The method as set forth in claim 90, wherein the notification comprises a wireless notification.

123. The method as set forth in claim 90, wherein the mark-up language file includes new information that has only become available subsequent to a prior notification.

124. The method as set forth in claim 90, wherein the mark-up language file includes a reduced size image that the user can select to produce a full-size image.

125. The method as set forth in claim 90, wherein the mark-up language file includes both graphical and textual information.

126. The method as set forth in claim 90, wherein the user interface is customized according to one or more user-selected preferences.

127. The method as set forth in claim 90, further comprising varying the amount of information contained in the mark-up language file according to one or more user-selected preferences received by the network server from the user's client device.

128. The method as set forth in claim 90, wherein the user-specific message storage area comprises a user-specific message mailbox within a messaging system comprising a plurality of message mailboxes for a respective plurality of users.

129. The method as set forth in claim 90, wherein the message comprises an HTML message.

130. The method as set forth in claim 129, wherein the HTML message comprises a data message encoded in HTML.

131. The method as set forth in claim 129, wherein the HTML message comprises a voice mail message encoded in HTML.

132. The method as set forth in claim 129, wherein the HTML message comprises a fax mail message encoded in HTML.

133. The method as set forth in claim 90, wherein the user-specific message storage area comprises a user-specific message mailbox within a searchable messaging database comprising a plurality of message mailboxes for a respective plurality of users.

134. The method as set forth in claim 90, wherein the message is received by the network server in a first file format other than a mark-up language file format, and further comprising converting the first file format to the mark-up language file format.

135. The method as set forth in claim 90, wherein:
the user request comprises an access request received from the user's client device by the network server, via the packet switched data network, using the Internet protocol,
the access request is indicative of a request by the user to gain access to the user-specific message storage area,
the network server making a determination to grant or deny the access request, and
in response to a determination to grant the access request, the network server transmitting the mark-up language file to the user's client device, via the packet switched data network, using the Internet protocol.

136. The method as set forth in claim 135, wherein the application program executing on the user's client device comprises a hyper-text browser.

137. The method as set forth in claim 136, wherein the hyper-text browser generates the access request.

138. The method as set forth in claim 135, wherein the access request includes authentication information that enables the network server to authenticate the user as being authorized to access the user-specific message storage area.

139. The method as set forth in claim 138, wherein the authentication information is entered into the user's client device and transmitted to the network server.

140. The method as set forth in claim 138, wherein the authentication information includes a user-specific name.

141. The method as set forth in claim 138, wherein the authentication information includes a user-specific password.

142. The method as set forth in claim 138, wherein the authentication information includes a user-specific name and a user-specific password.

143. The method as set forth in claim 142, wherein the application program executing on the user's client device comprises a hyper-text browser that generates the access request, including the authentication information.

144. The method as set forth in claim 143, wherein the hyper-text browser comprises a web browser.

145. The method as set forth in claim 143, wherein the packet switched data network comprises the Internet.

146. The method as set forth in claim 90, wherein the user interface provides additional links to other messages stored in the user-specific storage area.

147. The method as set forth in claim 146, wherein the message and the additional messages are each addressed to the user.

148. The method as set forth in claim 147, wherein the user interface further provides an indication of a total number of new messages stored in the user-specific storage area.

149. The method as set forth in claim 147, wherein the user interface further provides an indication of a total number of messages stored in the user-specific storage area.

150. The method as set forth in claim 147, wherein the user interface enables the user to browse through a plurality of messages stored in the user-specific storage area, including the message and the additional messages.

151. The method as set forth in claim 150, wherein the user interface provides icons or text designations to allow the user to browse through messages stored in the user-specific message storage area in sequence.

152. The method as set forth in claim 151, wherein the sequence of browsing can be to prior or subsequent messages relative to a currently displayed or highlighted message.

153. The method as set forth in claim 147, wherein the packet switched data network comprises the Internet.

154. The method as set forth in claim 146, wherein the user interface enables access to one or more search fields.

155. The method as set forth in claim 154, wherein:

the user interface enables the user to enter data into the one or more search fields;

the user interface enables the user to issue a search request to search the messages stored in the user-specific message storage area based on data entered by the user into the one or more search fields, and

the search request is subsequently received by the network server from the user's client device.

156. The method as set forth in claim 155, wherein:

in response to the search request, the network server returns a dynamically generated mark-up language file to the user's client device,

the content of the dynamically generated mark-up language file is based at least in part on results of the search request, and

the dynamically generated mark-up language file is enabled to be displayed to the user on the user's client device via the application program after it is received from the network server in an updated instance of the user interface.

157. The method as set forth in claim 156, wherein the updated instance of the user interface also provides links to one or more messages stored in the user-specific message storage area accessible by the network server, and the links to the one or more messages are generated as a result of the search request.

158. The method as set forth in claim 157, wherein the user is enabled to additionally select, at the time of the search

request submission, to save the search request for future resubmission to the network server.

159. The method as set forth in claim 158, wherein:

the user is enabled to assign a custom name to the saved search,

the custom name is enabled to be subsequently displayed to the user during an update of the user interface, and the custom name is enabled to be selected to initiate a resubmission of the search request to the network server.

160. The method as set forth in claim 159, wherein the resubmission of a saved search request is enabled to be manually requested by the user via the user interface or a subsequently updated instance of the user interface.

161. The method as set forth in claim 157, wherein the user may additionally select, upon viewing the results of the search request, to save the search request for future resubmission to the network server.

162. The method as set forth in claim 161, wherein:

the user is enabled to assign a custom name to the saved search,

the custom name is enabled to be subsequently displayed to the user during an update of the user interface, and the custom name is enabled to be selected to initiate a resubmission of the search request to the network server.

163. The method as set forth in claim 162, wherein the resubmission of a saved search request is enabled to be manually requested by the user via the user interface or a subsequently updated instance of the user interface.

164. The method as set forth in claim 146, wherein the user is enabled to request a message from the network server by selecting the link for that message.

165. The method as set forth in claim 164, wherein contents of the message requested by the user are embodied in a mark-up language.

166. The method as set forth in claim 165, wherein the contents of the message requested by the user are dynamically generated by the network server upon the receipt by the network server of the request for the message.

167. The method as set forth in claim 164, further comprising generating at least a portion of a content of the message as a result of a translation performed subsequent to the receipt by the network server of data intended for the user.

168. The method as set forth in claim 167, wherein the translation is performed on the network server.

169. The method as set forth in claim 167, wherein the translation is performed on a server remote to the network server.

170. The method as set forth in claim 167, wherein at least a portion of the data received at the network server that is intended for the user is in the form of audio information and the translation is a voice-to-text transcription.

171. The method as set forth in claim 167, wherein at least a portion of the data received at the network server that is intended for the user is in the form of facsimile information and the translation is a facsimile-to text-conversion.

172. The method as set forth in claim 167, wherein at least a portion of the data received at the network server that is intended for the user is in the form of text information in one linguistic form and the translation comprises translating the original linguistic form to another linguistic form.

173. The method as set forth in claim 146, wherein the user interface enables one or more additional message control functions.

174. The method as set forth in claim 173, wherein a particular one of the one or more message control functions allows a user to save one or more messages stored in the user-specific message storage area.

37

175. The method as set forth in claim 174, wherein a particular one of the one or more message control functions allows a user to delete one or more messages stored in the user-specific message storage area.

176. The method as set forth in claim 146, wherein mes- 5 sages stored in the user-specific storage area may be stored there indefinitely.

38

177. The method as set forth in claim 90, wherein the message is addressed to the user.

178. The method as set forth in claim 90, wherein the message is a confidential message addressed to the user and intended to be viewed by only the user.

* * * * *

UNITED STATES PATENT AND TRADEMARK OFFICE
CERTIFICATE OF CORRECTION

PATENT NO. : 7,934,148 B2
APPLICATION NO. : 11/609003
DATED : April 26, 2011
INVENTOR(S) : Charles R. Bobo, II

Page 1 of 1

It is certified that error appears in the above-identified patent and that said Letters Patent is hereby corrected as shown below:

Col. 26, lines 63-64, after "language file" (first instance in claim), delete "and delivering the mark-up language file".

Signed and Sealed this
Fourteenth Day of June, 2011

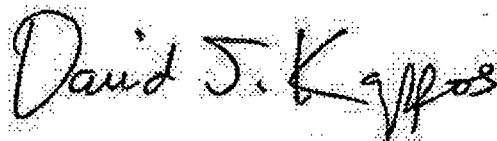

David J. Kappos
Director of the United States Patent and Trademark Office