

EXHIBIT 1



US007634504B2

(12) **United States Patent**
Amundson

(10) **Patent No.:** **US 7,634,504 B2**
(45) **Date of Patent:** **Dec. 15, 2009**

(54) **NATURAL LANGUAGE INSTALLER SETUP FOR CONTROLLER**

4,386,649 A 6/1983 Hines et al.
4,388,692 A 6/1983 Jones et al.
4,431,134 A 2/1984 Hendricks et al.
4,442,972 A 4/1984 Sahay et al.
4,446,913 A 5/1984 Krockner
4,479,604 A 10/1984 Didner
4,506,827 A 3/1985 Jamieson et al.

(75) Inventor: **John B. Amundson**, Minneapolis, MN (US)

(73) Assignee: **Honeywell International Inc.**, Morristown, NJ (US)

(*) Notice: Subject to any disclaimer, the term of this patent is extended or adjusted under 35 U.S.C. 154(b) by 137 days.

(Continued)

FOREIGN PATENT DOCUMENTS

(21) Appl. No.: **11/421,833**

DE 3334117.6 4/1985

(22) Filed: **Jun. 2, 2006**

(65) **Prior Publication Data**

US 2006/0206220 A1 Sep. 14, 2006

(Continued)

Related U.S. Application Data

OTHER PUBLICATIONS

(63) Continuation-in-part of application No. 10/726,245, filed on Dec. 2, 2003, now Pat. No. 7,181,317.

“A Full Range of Alternative User Interfaces For Building Occupants and Operators,” <http://www.automatedbuildings.com/news/jan00/articles/andover/andover.htm>, 5 pages, dated Jan. 2000, printed Sep. 20, 2004.

(51) **Int. Cl.**
G06F 17/00 (2006.01)

(Continued)

(52) **U.S. Cl.** **707/104.1; 707/101; 707/102; 707/103 R; 700/276**

Primary Examiner—Isaac M Woo

(58) **Field of Classification Search** **707/1-10, 707/100-104.1, 200-206; 700/275-285**
See application file for complete search history.

(57) **ABSTRACT**

(56) **References Cited**

Controllers and methods for programming configuration information are disclosed. An illustrative controller can include an interview question generator adapted to generate questions relating to the installation or setup of the controller and/or one or more components controlled by the controller, a user interface including a display screen adapted to display interview questions to a user along with at least two answers for each interview question, and a memory unit for storing operational parameters of the controller based at least in part on user responses to the interview questions.

U.S. PATENT DOCUMENTS

4,079,366 A 3/1978 Wong
4,174,807 A 11/1979 Smith et al.
4,206,872 A 6/1980 Levine
4,224,615 A 9/1980 Penz
4,264,034 A 4/1981 Hyltin et al.
4,298,946 A 11/1981 Hartsell et al.
4,308,991 A 1/1982 Peinetti et al.
4,337,822 A 7/1982 Hyltin et al.
4,382,544 A 5/1983 Stewart

18 Claims, 34 Drawing Sheets

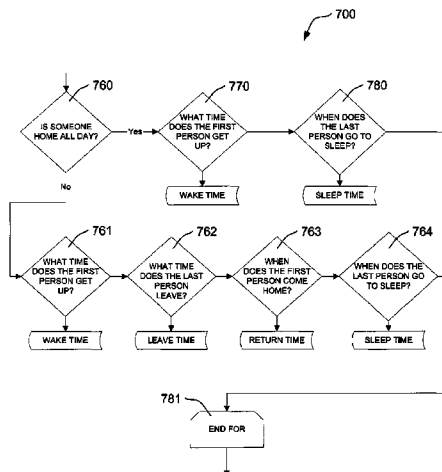

U.S. PATENT DOCUMENTS

4,606,401 A	8/1986	Levine et al.	6,621,507 B1	9/2003	Shah	
4,621,336 A	11/1986	Brown	6,786,421 B2	9/2004	Rosen	
4,622,544 A	11/1986	Bially et al.	6,824,069 B2	11/2004	Rosen	
4,717,333 A	1/1988	Carignan	6,891,838 B1 *	5/2005	Petite et al.	370/401
4,725,001 A	2/1988	Carney et al.	6,967,565 B2	11/2005	Lingemann	
4,819,714 A	4/1989	Otsuka et al.	7,050,026 B1	5/2006	Rosen	
4,837,731 A	6/1989	Levine et al.	7,246,087 B1 *	7/2007	Ruppelt et al.	705/27
4,881,686 A	11/1989	Mehta	2001/0029585 A1	10/2001	Simon et al.	
4,918,439 A	4/1990	Wozniak et al.	2001/0042684 A1	11/2001	Essalik et al.	
4,948,040 A	8/1990	Kobayashi et al.	2001/0052459 A1	12/2001	Essalik et al.	
4,992,779 A	2/1991	Sugino et al.	2002/0005435 A1	1/2002	Cottrell	
4,997,029 A	3/1991	Otsuka et al.	2002/0092779 A1	7/2002	Essalik et al.	
5,012,973 A	5/1991	Dick et al.	2003/0034897 A1	2/2003	Shamoon et al.	
5,038,851 A	8/1991	Mehta	2003/0034898 A1	2/2003	Shamoon et al.	
5,053,752 A	10/1991	Epstein et al.	2003/0121652 A1	7/2003	Carey et al.	
5,065,813 A	11/1991	Berkeley et al.	2003/0123224 A1	7/2003	LaCroix et al.	
5,086,385 A	2/1992	Launey et al.	2003/0142121 A1	7/2003	Rosen	
5,088,645 A	2/1992	Bell	2003/0150926 A1	8/2003	Rosen	
5,140,310 A	8/1992	DeLuca et al.	2003/0150927 A1	8/2003	Rosen	
5,161,606 A	11/1992	Berkeley et al.	2004/0074978 A1	4/2004	Rosen	
5,170,935 A	12/1992	Federspiel et al.	2004/0193324 A1	9/2004	Hoog et al.	
5,181,653 A	1/1993	Foster et al.	2004/0245352 A1	12/2004	Smith	
5,230,482 A	7/1993	Ratz et al.				
5,238,184 A	8/1993	Adams				
5,251,813 A	10/1993	Kniepkamp				
5,259,445 A	11/1993	Pratt et al.				
5,329,991 A	7/1994	Metha et al.				
5,348,078 A	9/1994	Dushane et al.				
5,386,577 A	1/1995	Zenda				
5,482,209 A	1/1996	Cochran et al.				
5,526,422 A	6/1996	Keen				
5,537,106 A	7/1996	Mitsubishi				
5,566,879 A	10/1996	Longtin				
5,570,837 A	11/1996	Brown et al.				
5,673,850 A	10/1997	Uptegraph				
5,761,083 A	6/1998	Brown et al.				
5,782,296 A	7/1998	Metha				
5,818,428 A	10/1998	Eisenbrandt et al.				
5,873,519 A	2/1999	Beilfuss				
5,877,957 A	3/1999	Bennett				
5,886,697 A	3/1999	Naughton et al.				
5,901,183 A	5/1999	Garin et al.				
5,902,183 A	5/1999	D'Souza				
5,937,942 A	8/1999	Bias et al.				
5,947,372 A	9/1999	Tiernan				
6,020,881 A	2/2000	Naughton et al.				
6,032,867 A	3/2000	Dushane et al.				
6,059,195 A	5/2000	Adams et al.				
6,081,197 A	6/2000	Garrick et al.				
6,121,875 A	9/2000	Hamm et al.				
6,140,987 A	10/2000	Stein et al.				
6,192,282 B1	2/2001	Smith et al.				
6,196,467 B1	3/2001	Dushane et al.				
6,208,331 B1	3/2001	Singh et al.				
6,236,326 B1	5/2001	Murphy				
6,285,912 B1	9/2001	Ellison et al.				
6,290,140 B1	9/2001	Pesko et al.				
6,315,211 B1	11/2001	Sartain et al.				
6,318,639 B1	11/2001	Toth				
6,330,806 B1	12/2001	Beaverson et al.				
6,344,861 B1	2/2002	Naughton et al.				
6,351,693 B1	2/2002	Monie et al.				
6,398,118 B1	6/2002	Rosen et al.				
6,478,233 B1	11/2002	Shah				
6,502,758 B2	1/2003	Cottrell				
6,518,957 B1	2/2003	Lehtinen et al.				
6,578,770 B1	6/2003	Rosen				
6,580,950 B1	6/2003	Johnson et al.				
6,581,846 B1	6/2003	Rosen				
6,595,430 B1	7/2003	Shah				
6,619,555 B2	9/2003	Rosen				

FOREIGN PATENT DOCUMENTS

EP	0678204	3/2000
EP	0985994	3/2000
EP	1074009	7/2001
SI	20556	10/2001
WO	WO 97/11448	3/1997
WO	WO 97/39392	10/1997
WO	WO 01/52515	7/2001
WO	WO 01/79952	10/2001
WO	WO 01/93779	12/2001

OTHER PUBLICATIONS

“CorAccess Systems/In Home,” <http://web.archive.org/web/20011212084427/www.coraccess.com/home.html>, 1 page, copyright 2001, printed Aug. 19, 2004.

“HAI Company Background,” http://www.homeauto.com/AboutHAI/abouthai_main.htm, 2 pages, printed Aug. 19, 2004.

“High-tech options take hold in new homes—200-08-28—Dallas Business Journal,” <http://bizjournals.com/dallas/stories/2000/08/28/focus4>, 3 pages, dated Aug. 28, 2000, printed Aug. 19, 2004.

“Home Toys Review—TouchLine”, <http://www.hometoys.com/htinews/aug99/reviews/touchline.htm>, 3 pages, dated Aug. 1999, printed Aug. 20, 2004.

“Mark of Excellence Award Finalist Announced,” <http://64.233.167.104/search?Q=cache:ciOA2YtYaBIJ:www.hometoys.com/releases/mar...>, 6 pages, Leopard Touchscreen on p. 2, dated prior to Mar. 4, 2000, printed Aug. 20, 2004.

“Product Review—Philips Pronto Remote Control,” http://hometheaterhifi.com/volume_6_2/philipsprontoremotecontrol.html, 5 pages, dated May 1999, printed Aug. 20, 2004.

“RC X10 Automation Forum: Control your Heating and Cooling System with Pronto(1/1),” <http://www.remotecentral.com/cgi-bin/mboard/rc-x10/thread.cgi?12>, 2 pages, dated Apr. 23, 1999, printed Aug. 20, 2004.

“Spotlight on integrated systems,” Custom Builder, V8, N2, p. 66(6), Mar.-Apr. 1993.

“Vantage Expands Controls For Audio/Video, HVAC and Security,” <http://www.hometoys.com/htinews/aug99/releases/vantage03.htm>, 2 pages, dated Aug. 3, 1999, printed Aug. 20, 2004.

ADI, “Leopard User Manual,” 93 pages, 2001.

Adicon 2500, “The Automator,” 4 pages, Oct.-Dec. 2000.

ADT Security Services, “iCenter Advanced User Interface 8142ADT,” Installation and Setup Guide, 5 pages, May 2001; First Sale Feb. 2001.

ADT Security Systems, “iCenter Advanced User Interface 8142ADT User Guide,” pp. 1-136, 2001.

Aprilaire Electronic Thermostats Models 8344, 8346, 8348, 8363, 8365, 8366 Operating Instructions, 8 pages, prior to Dec. 2, 2003.

- Aube Technologies, Electronic Thermostat for Heating System Model TH135-01, 5 pages, Aug. 14, 2001.
- Aube Technologies, TH140-28 Electronic Programmable Thermostat, Installation Instructions and User Guide, pp. 1-4, Jan. 22, 2004.
- AutomatedBuildings.com Article—"Thin Client" Solutions, "Pressure, Air Flow, Temperature, Humidity & Valves," Dwyer Instruments, Inc., 5 pages, printed Sep. 20, 2004.
- Blake et al., "Seng 310 Final Project Demo Program" Illustration, 3 pages, Apr. 6, 2001.
- Blake et al., "Seng 310 Final Project" Report, dated Apr. 6, 2001.
- Blister Pack Insert from a Ritetemp 8082 Touch Screen Thermostat Product, 2 pages, 2002.
- Braeburn Model 3000 Owner's Manual, pp. 1-13, 2001.
- Braeburn Model 5000 Owners Manual, pp. 1-17, 2001.
- BRK Electronics Maximum Protection Plus Ultimate Convenience Smoke Alarm, 24 pages, prior to Dec. 2, 2003.
- BRK First Alert, User's Manual, Smoke and Fire Alarms, pp. 1-7, Nov. 2002.
- Business Wire, "MicroTouch Specialty Products Group to Capitalize on Growing Market for Low-Cost Digital Matrix Touchscreens," p. 1174 (2 pages), Jan. 6, 1999.
- Cardio Manual, available at <http://www.secant.ca/En/Documentation/Cardio2e-Manual.pdf>, Cardio Home Automation Inc., 55 pages, printed Sep. 28, 2004.
- Cardio, by Secant; <http://www.hometoys.com/hitnews/apr98/reviews/cardio.htm>, "HTINews Review," Feb. 1998, 5 pages, printed Sep. 14, 2004.
- Carrier Microelectronic Programmable Thermostat Owner's Manual, pp. 1-24, May 1994.
- Carrier TSTATCCRFO1 Programmable Digital Thermostat, pp. 1-21, prior to Dec. 2, 2003.
- Carrier, "Programmable Dual Fuel Thermostat," Installation, Start-Up & Operating Instructions, pp. 1-12, Oct. 1998.
- Carrier, "Programmable Thermostats," Installation, Start-Up & Operating Instructions, pp. 1-16, Sep. 1998.
- Carrier, "Standard Programmable Thermostat," Homeowner's Manual, pp. 1-8 pp. 1998.
- Carrier, "Thermidistat Control," Installation, Start-Up, and Operating Instructions, pp. 1-12, Aug. 1999.
- Climatouch, User Manual, Climatouch CT03TSB Thermostat, Climatouch CT03TSHB Thermostat with Humidity Control, Outdoor UHF Temperature Transmitter 217S31, 19 pages, Printed Sep. 15, 2004.
- CorAccess, "Companion 6," User Guide, pp. 1-20, Jun. 17, 2002.
- Danfoss RT51/51RF & RT52/52RF User Instructions, 2 pages, Jun. 2004.
- DeKoven et al., "Designing Collaboration in Consumer Products," 2 pages, 2001.
- DeKoven et al., "Measuring Task Models in Designing Intelligent Products," pp. 188-189, 2002.
- Domotique Secant Home Automation—Web Page, available at <http://www.secant.ca/En/Company/Default.asp>, 1 page, printed Sep. 28, 2004.
- Fire Smoke Alarm, Ionization Models AD, ADC Photoelectric Model Pad, 4 pages, prior to Dec. 2, 2003.
- Freudenthal et al., "Communicating extensive smart home functionality to users of all ages: the design of a mixed-initiative multimodal thermostat-interface," pp. 34-39, Mar. 12-13, 2001.
- Gentex Corporation, HD135, 135° Fixed Temperature Heat Detector AC Powered, 120V, 60Hz With Battery Backup, Installation Instructions—Owner's Information, pp. 1-5, Jun. 1, 1998.
- Gentex Corporation, 9000 Series, Photoelectric Type Single Station/Multi-Station Smoke Alarms AC Powered With Battery Backup, Installation Instructions—Owner's Information, pp. 9-1 to 9-6, Jan. 1, 1993.
- Honeywell Bravis Deluxe Programmable Thermostat, pp. 1-20, 2002.
- Honeywell Bravis T8602C Chronotherm IV Deluxe Programmable Thermostats, Installation Instructions, pp. 1-12, 2002.
- Honeywell CT8602C Professional Fuel Saver Thermostat, pp. 1-6, 1995.
- Honeywell Electronic Programmable Thermostat, Owner's Guide, pp. 1-20, 2003.
- Honeywell Electronic Programmable Thermostats, Installation Instructions, pp. 1-8, 2003.
- Honeywell News Release, "Honeywell's New Sysnet Facilities Integration System For Boiler Plant and Combustion Safety Processes," 4 pages, Dec. 15, 1995.
- Honeywell T8002 Programmable Thermostat, Installation Instructions, pp. 1-8, 2002.
- Honeywell T8602A,B,C,D and TS8602A,C Chronotherm III Fuel Saver Thermostats, Installation Instructions, pp. 1-12, 1995.
- Honeywell T8602D Chronotherm IV Deluxe Programmable Thermostats, Installation Instructions, pp. 1-12, 2002.
- Honeywell TH8000 Series Programmable Thermostats, Owner's Guide, pp. 1-44, 2004.
- Honeywell, "Introduction of the S7350A Honeywell WebPAD Information Appliance," Home and Building Control Bulletin, 2 pages, Aug. 29, 2000; Picture of WebPad Device with touch screen, 1 Page; and screen shots of WebPad Device, 4 pages.
- Honeywell, "Vision Pro 8000 Touchscreen Programmable Thermostat," Honeywell International, Inc., 40 pages, 2004.
- Honeywell, "W7006A Home Controller Gateway User Guide," 31 pages, Jul. 2001.
- Honeywell, MagicStat® CT3200 Programmable Thermostat, Installation and Programming Instructions, pp. 1-24, 2001.
- http://www.cc.gatech.edu/computing/classes/cs6751_94_fall/group/climate-2/node1.html, "Contents," 53 pages, printed Sep. 20, 2004.
- <http://www.hometoys.com/hitnews/apr99/releases/hal01.htm>, HTI News Release, pp. 1-3.
- http://www.ritetemp.info/rtMenu_13.html, Rite Temp 8082, 6 pages, printed Jun. 20, 2003.
- <http://www.thermostatsales.com>, Robertshaw, "9610 Digital Programmable Thermostat," 3 pages, printed Jun. 17, 2004.
- <http://www.thermostatsales.com>, Robertshaw, "9700 Deluxe Programmable Thermostat" 3 pages, printed Jun. 17, 2004.
- <http://www.thermostatsales.com>, Robertshaw, "9710 Deluxe Programmable Thermostat," 3 pages, printed Jun. 17, 2004.
- <http://www.thermostatsales.com>, Robertshaw, "9720 Deluxe Programmable Thermostat," 3 pages, printed Jun. 17, 2004.
- Hunter, "44200/44250," Owner's Manual, 32 pages, printed prior to Dec. 2, 2003.
- Hunter, "44300/44350," Owner's Manual, 35 pages, printed prior to Dec. 2, 2003.
- Hunter, "Auto Saver 550", Owner's Manual Model 44550, 44 pages, printed prior to Dec. 2, 2003.
- Install Guide for Ritetemp Thermostat 8082, 6 pages, 2002.
- Invensys Deluxe Programmable Thermostats 9700, 9701, 9715, 9720, User's Manual, 21 pages, prior to Dec. 2, 2003.
- Invensys™, "9700i 9701i 9715i 9720i Deluxe Programmable Thermostats," User's Manual, pp. 1-28, printed prior to Dec. 2, 2003.
- Lux TX9000 Installation, 3 pages, prior to Dec. 2, 2003.
- Lux, "ELV1 Programmable Line Voltage Thermostat," Owner's Manual, 3 pages, printed prior to Dec. 2, 2003.
- Lux, "511 Series Smart Temp Electronic Thermostat," Owner's Manual, 3 pages, printed prior to Dec. 2, 2003.
- Lux, "600 Series Smart Temp Electronic Thermostat," Owner's Manual, 3 pages, printed prior to Dec. 2, 2003.
- Lux, "602 Series Multi-Stage Programmable Thermostat," Owner's Manual, 2 pages, printed prior to Dec. 2, 2003.
- Lux, "605/2110 Series Programmable Heat Pump Thermostat," Owner's Manual, 3 pages, printed prior to Dec. 2, 2003.
- Lux, "700/9000 Series Smart Temp Electronic Thermostat," Owner's Manual, 3 pages, printed prior to Dec. 2, 2003.
- Lux, "PSPH521 Series Programmable Heat Pump Thermostat," Owner's Manual, 3 pages, printed prior to Dec. 2, 2003.
- Lux, "TX1500 Series Smart Temp Electronic Thermostat," Owner's Manual, 6 pages, printed prior to Dec. 2, 2003.
- Lux, "TX500 Series Smart Temp Electronic Thermostat," Owner's Manual, 3 pages, printed prior to Dec. 2, 2003.
- Metasys, "HVAC PRO for Windows User's Manual," 308 pages, 1998.
- Mounting Template for Ritetemp Thermostat 8082, 1 page, 2002.
- Operation Manual for Ritetemp Touch Screen Thermostat 8082, 8 pages, 2002.

- Proliphix Inc., "Web Enabled IP Thermostats," 2 pages, prior to Dec. 2, 2003.
- Quick Start Guide for Ritetemp Thermostat 8082, 1 page, 2002.
- Remote Control Power Requirement for Ritetemp Thermostat 8082, 1 page, 2002.
- Ritetemp Operation 8029, 3 pages, Jun. 19, 2002.
- Ritetemp Operation 8050, 5 pages, Jun. 26, 2002.
- Ritetemp Operation 8085, pp. 1-6, prior to Dec. 2, 2003.
- Sealed Unit Parts Co., Inc., Supco & CTC Thermostats . . . loaded with features, designed for value!, 6 pages, prior to Dec. 2, 2003.
- Totaline Model P474-1035 Owner's Manual Programmable 5-2 Day Digital Thermostat, pp. 1-21, prior to Dec. 2, 2003.
- Totaline Star CPE230RF, Commercial Programmable Thermostat Wireless Transmitter, Owner's Manual, pp. 1-16, Oct. 1998.
- Totaline Star P/N P474-0130 Non-Programmable Digital Thermostat Owner's Manual, pp. 1-22, prior to Dec. 2, 2003.
- Totaline, "1 For All programmable Digital Thermostat," Owner's Manual P/N P374-1100FM, 23 pages, Nov. 1998.
- Totaline, "1 For All Programmable Digital Thermostat," Owner's Manual P/N P474-1050, 21 pages, Nov. 1998.
- Totaline, "1 For All Programmable Digital Thermostat," Owner's Manual P/N P374-1100, 24 pages, Apr. 2001.
- Totaline, "Intellistat Combination Temperature and Humidity Control," Owner's Manual P/N P374-1600, 25 pages, Jun. 2001.
- Totaline, "Programmable Thermostat Configurable for Advanced Heat Pump or Dual Fuel Operation," Owner's Manual P/N P374-1500, 24 pages, Jun. 1999.
- Totaline, "Instructions P/N P474-1010", Manual, 2 pages, Dec. 1998.
- Totaline, "Programmable Thermostat", Homeowner's Guide, 27 pages, Dec. 1998.
- Totaline, "Wireless Programmable Digital Thermostat," Owner's Manual 474-1100RF, 21 pages, 2000.
- Trouble Shooting Guide for Ritetemp Thermostat 8082, 1 page, 2002.
- U.S. Appl. No. 10/654,230, filed Sep. 3, 2003, entitled "Programmable Thermostat Incorporating a Liquid Crystal Display and Having a Feature for Mounting Horizontally, Vertically and any Intermediate Orientation."
- U.S. Appl. No. 10/654,235, filed Sep. 3, 2003, entitled "Programmable Thermostat Incorporating a Liquid Crystal Display Selectively Presenting Adaptable System Menus Including Changeable Interactive Virtual Buttons."
- Visor Handheld User Guide, Copyright 1999-2000.
- Warmly Yours, "Model TH111GFCI-P (120 VAC)," Manual, pp. 1-4, printed prior to Dec. 2, 2003.
- White-Rodgers 1F80-224 Programmable Electronic Digital Thermostat, Installation and Operation Instructions, 8 pages, prior to Dec. 2, 2003.
- White-Rodgers Installation Instructions for Heating & Air Conditioning 1F78 Non-Programmable Thermostat, 6 pages, prior to Dec. 2, 2003.
- White-Rodgers, "Installation Instructions for Heating & Air Conditioning 1F72 5/2 Day Programmable Heat Pump Thermostat," 8 pages, printed prior to Dec. 2, 2003.
- White-Rodgers, "Installation Instructions for Heating & Air Conditioning 1F78 5/2 Day Programmable Thermostat," 7 pages, printed prior to Dec. 2, 2003.
- White-Rodgers, "Comfort-Set 90 Series Thermostat," Manual, pp. 1-24, printed prior to Dec. 2, 2003.
- White-Rodgers, "Comfort-Set III Thermostat," Manual, pp. 1-44, printed prior to Dec. 2, 2003.
- White-Rodgers, 1F80-240 "(for Heating Only systems) Programmable Electronic Digital Thermostat," Installation and Operation Instructions, 8 pages, printed prior to Dec. 2, 2003.
- White-Rodgers, 1F80-241 "Programmable Electronic Digital Thermostat," Installation and Operation Instructions, 6 pages, printed prior to filing date.
- White-Rodgers, 1F80-261 "Programmable Electronic Digital Thermostat," Installation and Operation Instructions, 8 pages, printed prior to Dec. 2, 2003.
- White-Rodgers, 1F81-261 "Programmable Electronic Digital Multi-Stage Thermostat," Installation and Operation Instructions, 8 pages, printed prior to Dec. 2, 2003.
- White-Rodgers, 1F82-261 "Programmable Electronic Digital Heat Pump Thermostat," Installation and Operation Instructions, 8 pages, prior to Dec. 2, 2003.
- White-Rodgers, Comfort-Set 90 Series Premium, 4 pages, prior to Dec. 2, 2003.
- www.icmcontrols.com, Simplecomfort, SC3000 Single Stage Heat/Single Stage Cool or Single Stage Heat Pump/Manual Changeover, 1 page, printed prior to Dec. 2, 2003.
- www.icmcontrols.com, Simplecomfort, SC3001 Single Stage Heat/Single Stage Cool or Single Stage Heat Pump/Manual Changeover, 1 page, printed prior to Dec. 2, 2003.
- www.icmcontrols.com, Simplecomfort, SC3006 Single Stage Heat/Single Stage Cool or Single Stage Heat Pump/Manual Changeover, 1 page, printed prior to Dec. 2, 2003.
- www.icmcontrols.com, Simplecomfort, SC3201 2 Stage Heat Pump Manual Changeover, 1 page, printed prior to Dec. 2, 2003.
- www.icmcontrols.com, Simplecomfort, SC3801 2 Stage Heat/2 Stage Cool 2 Stage Heat Pump/Audio Changeover, 1 page, printed prior to Dec. 2, 2003.

* cited by examiner

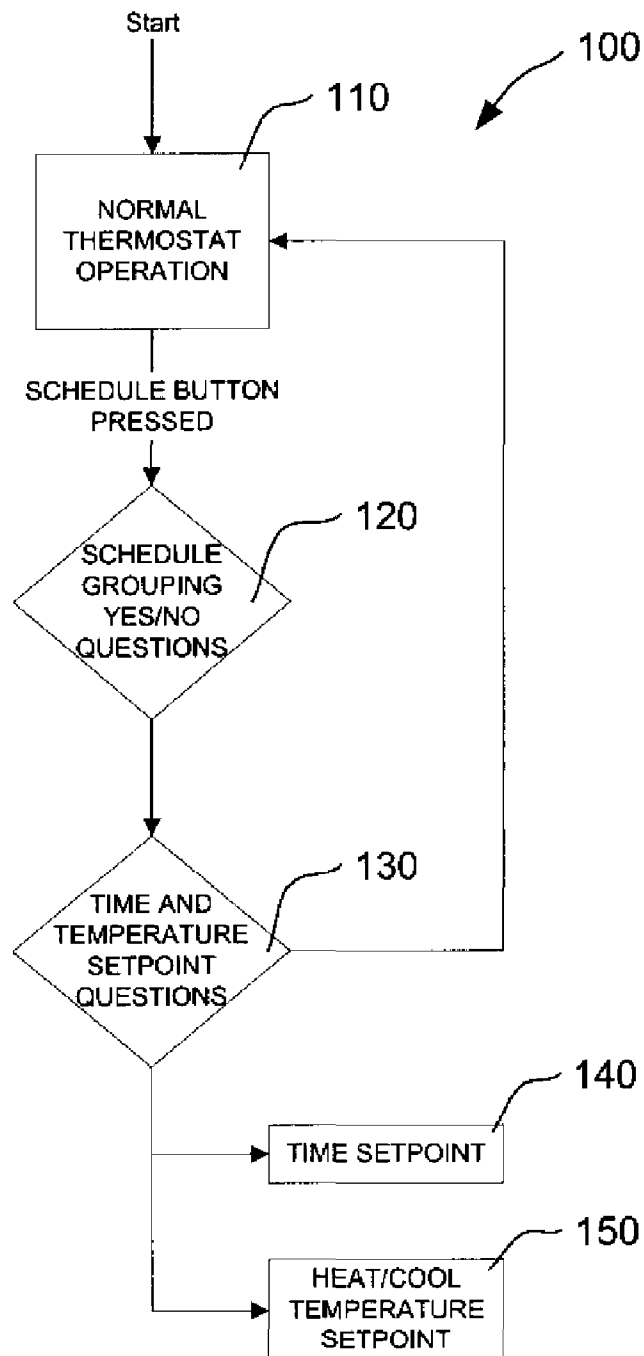

Figure 1

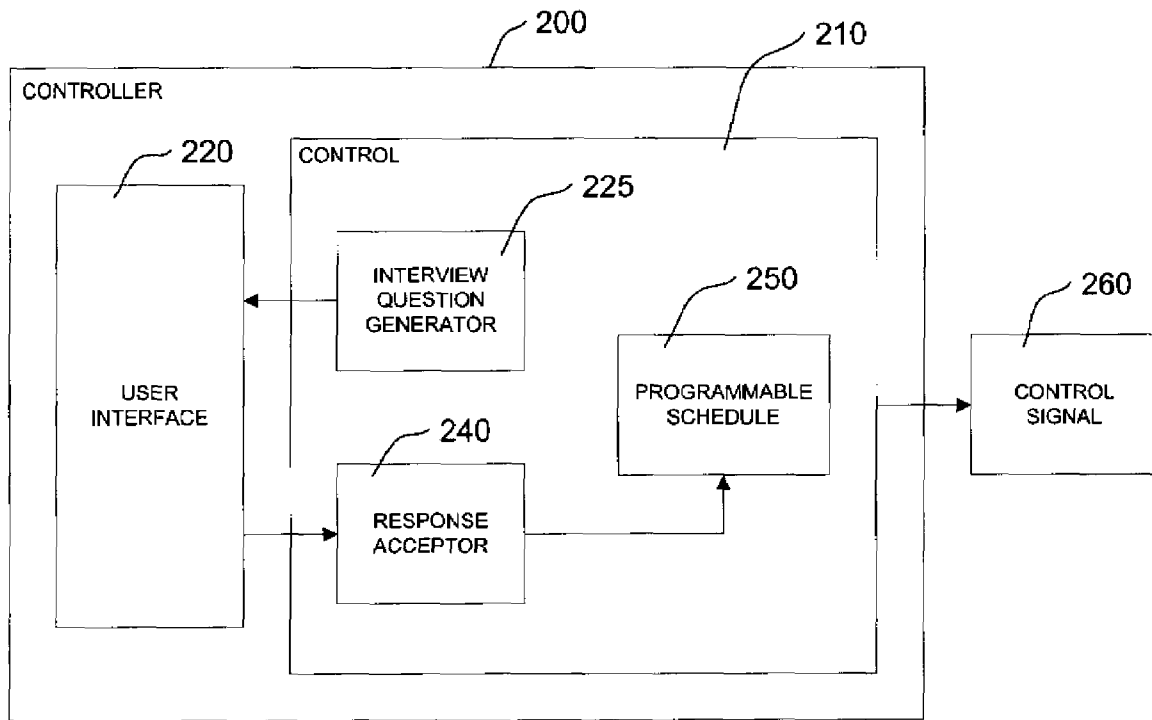

Figure 2

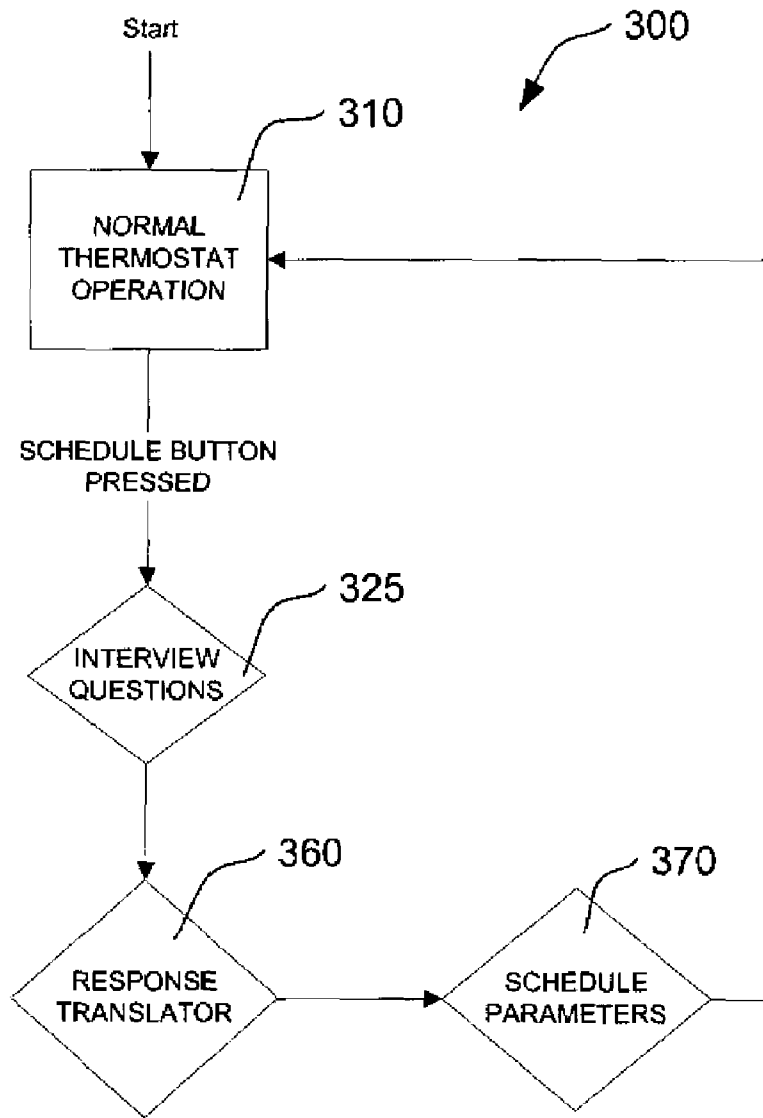

Figure 3

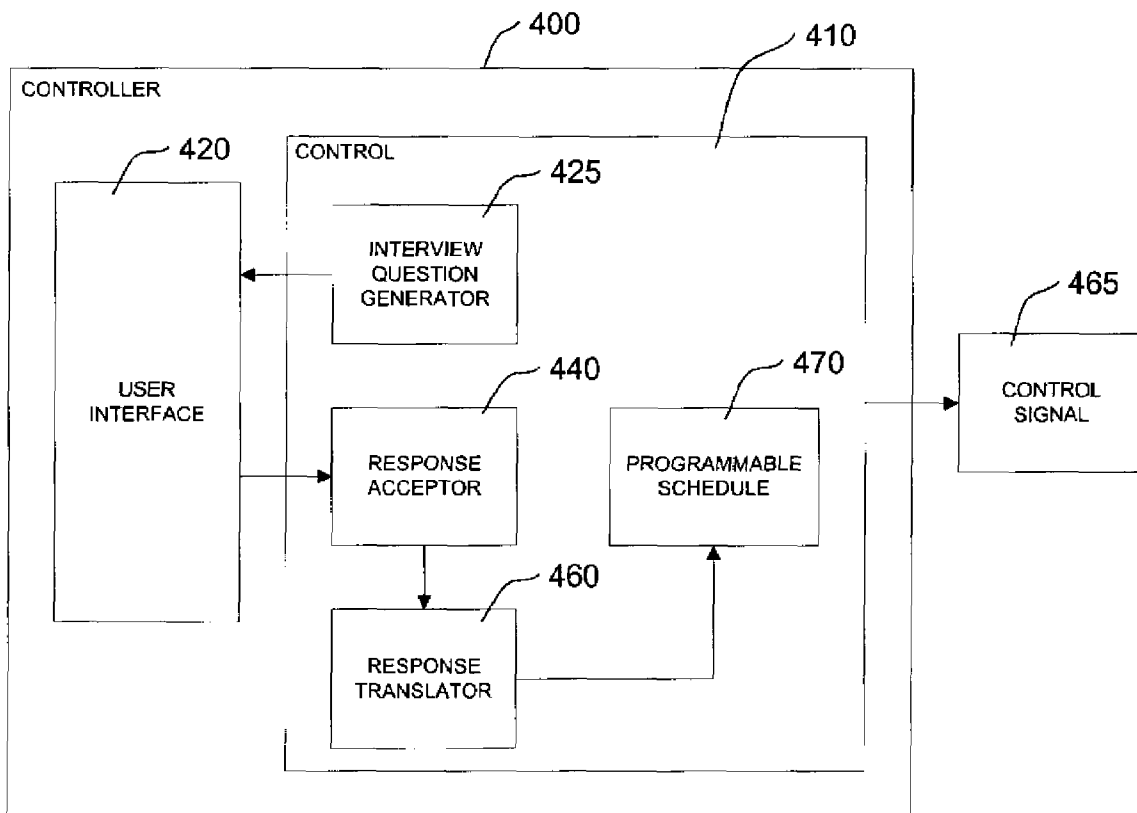

Figure 4A

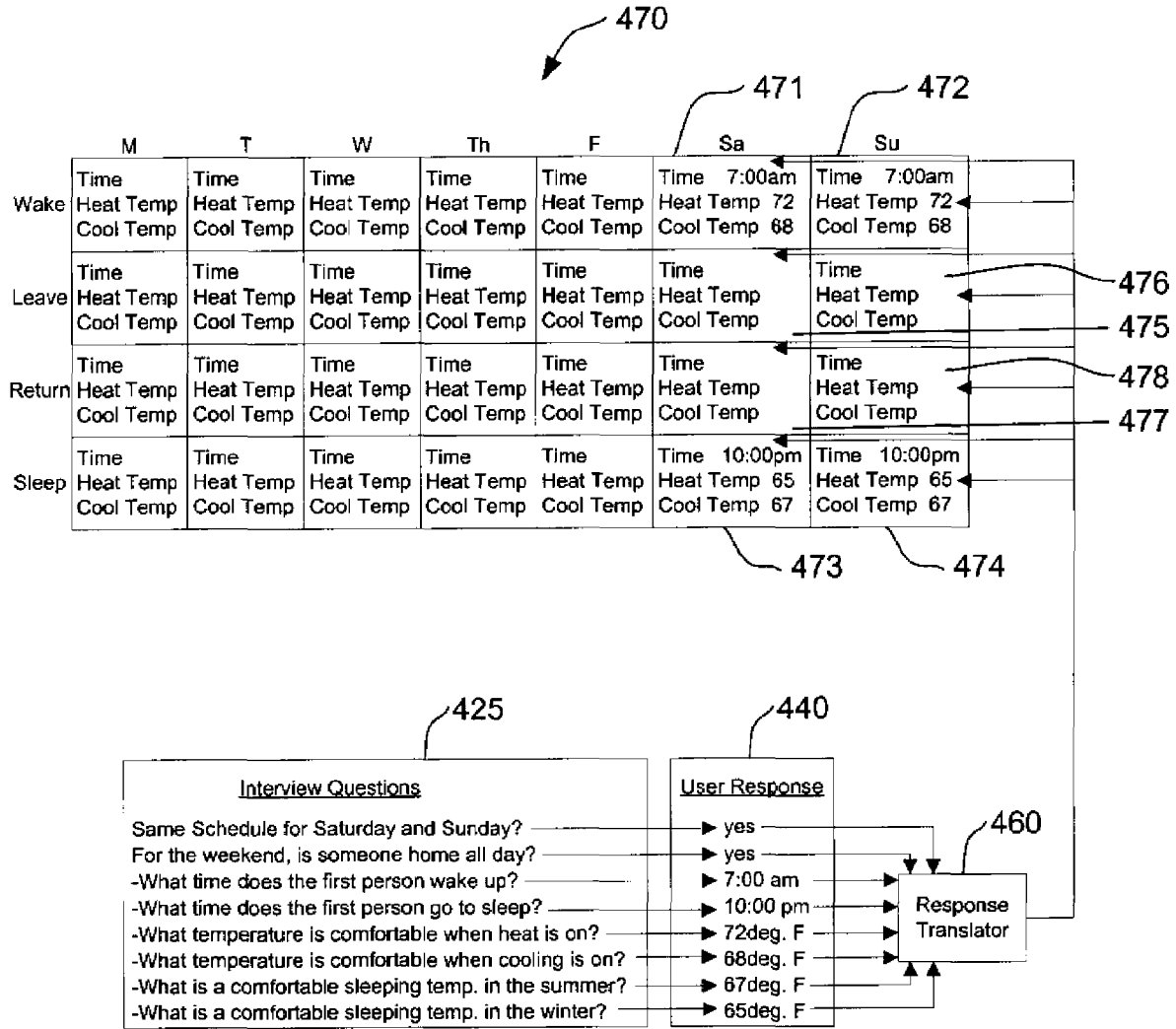

Figure 4B

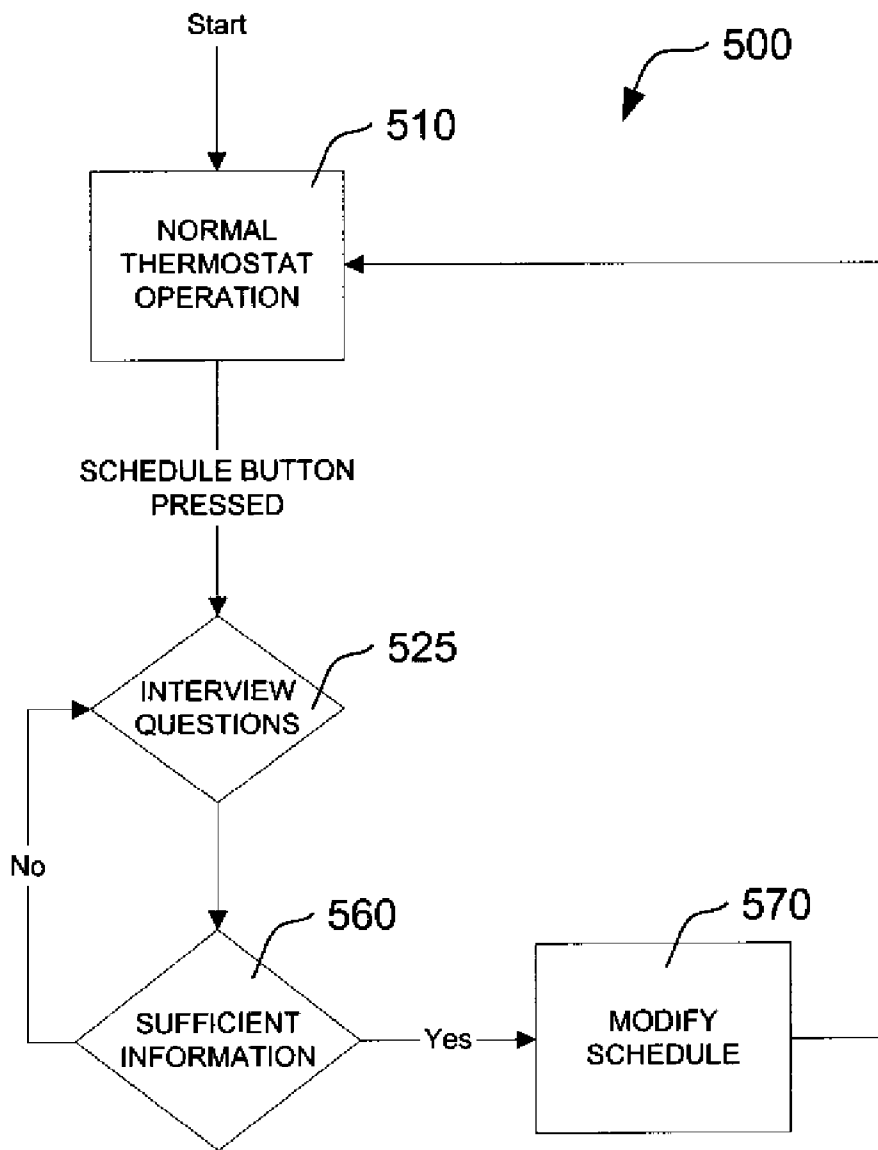

Figure 5

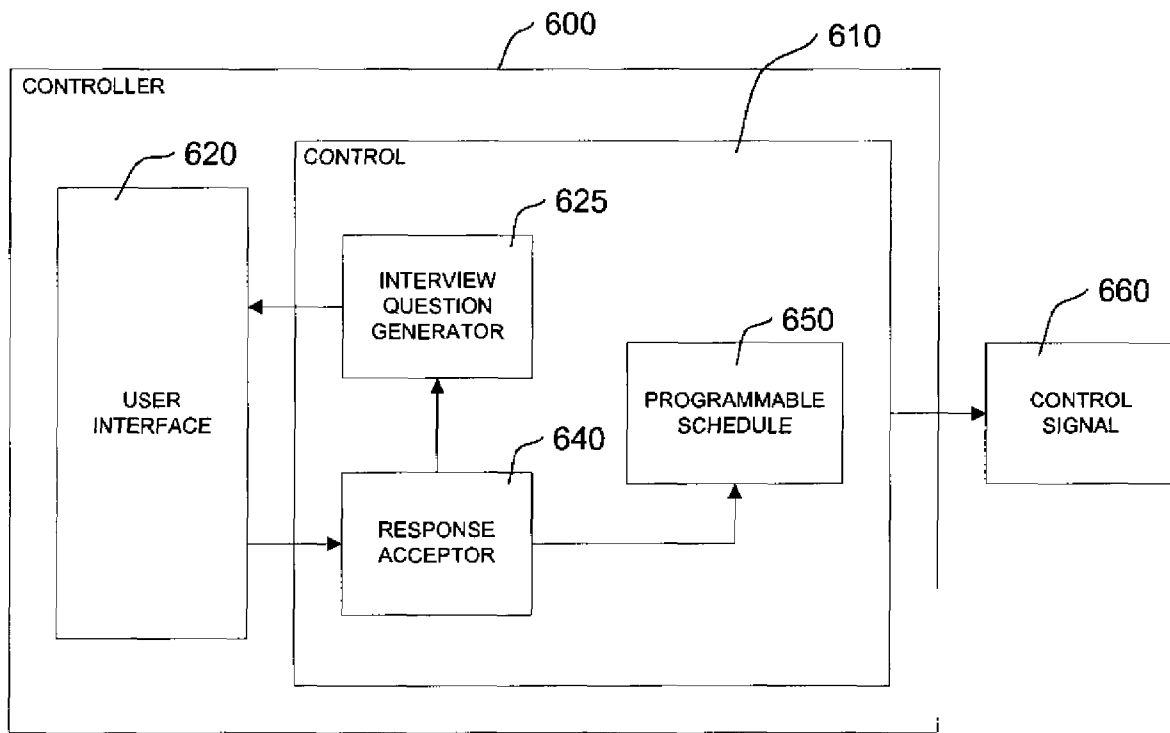

Figure 6

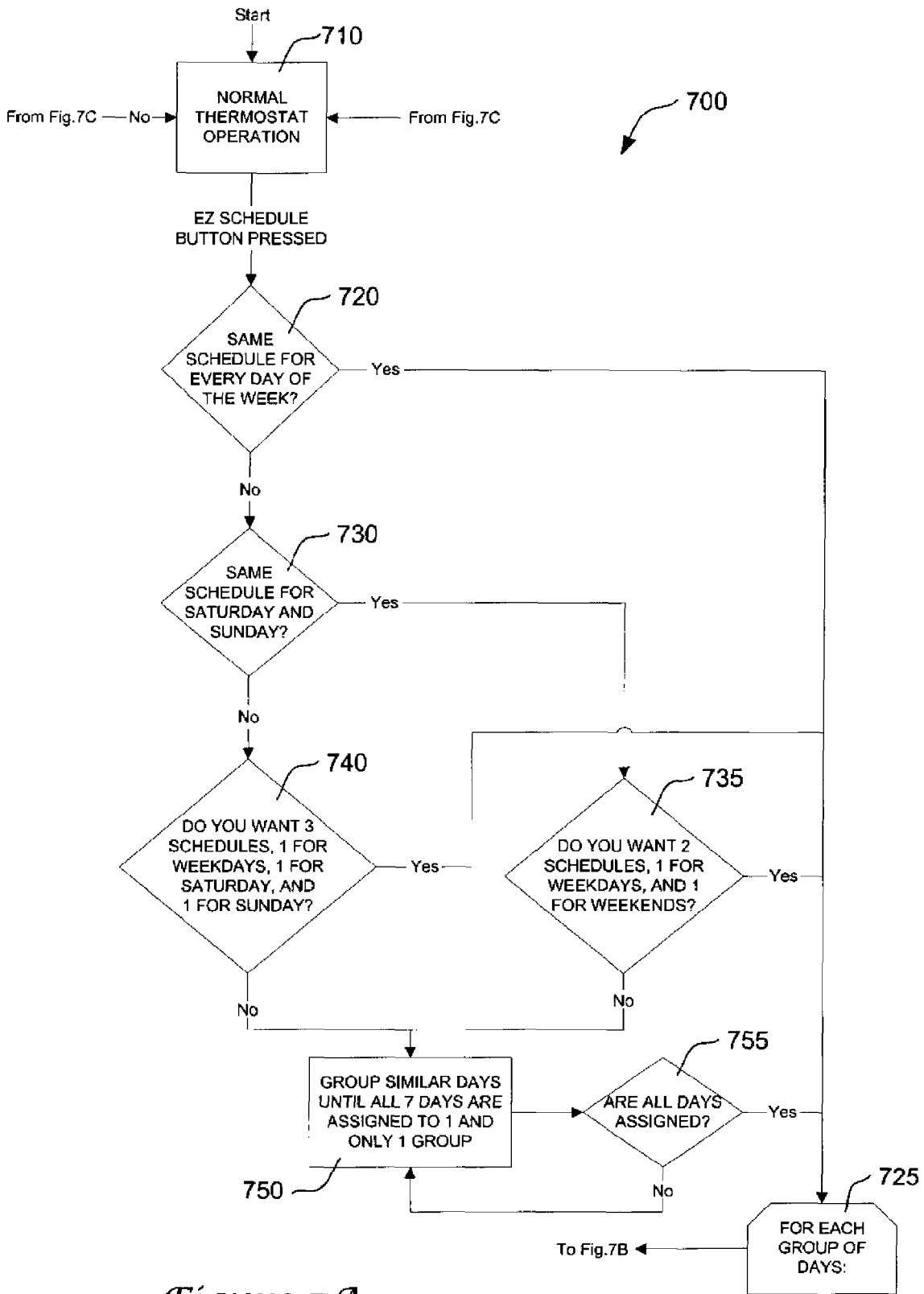

Figure 7A

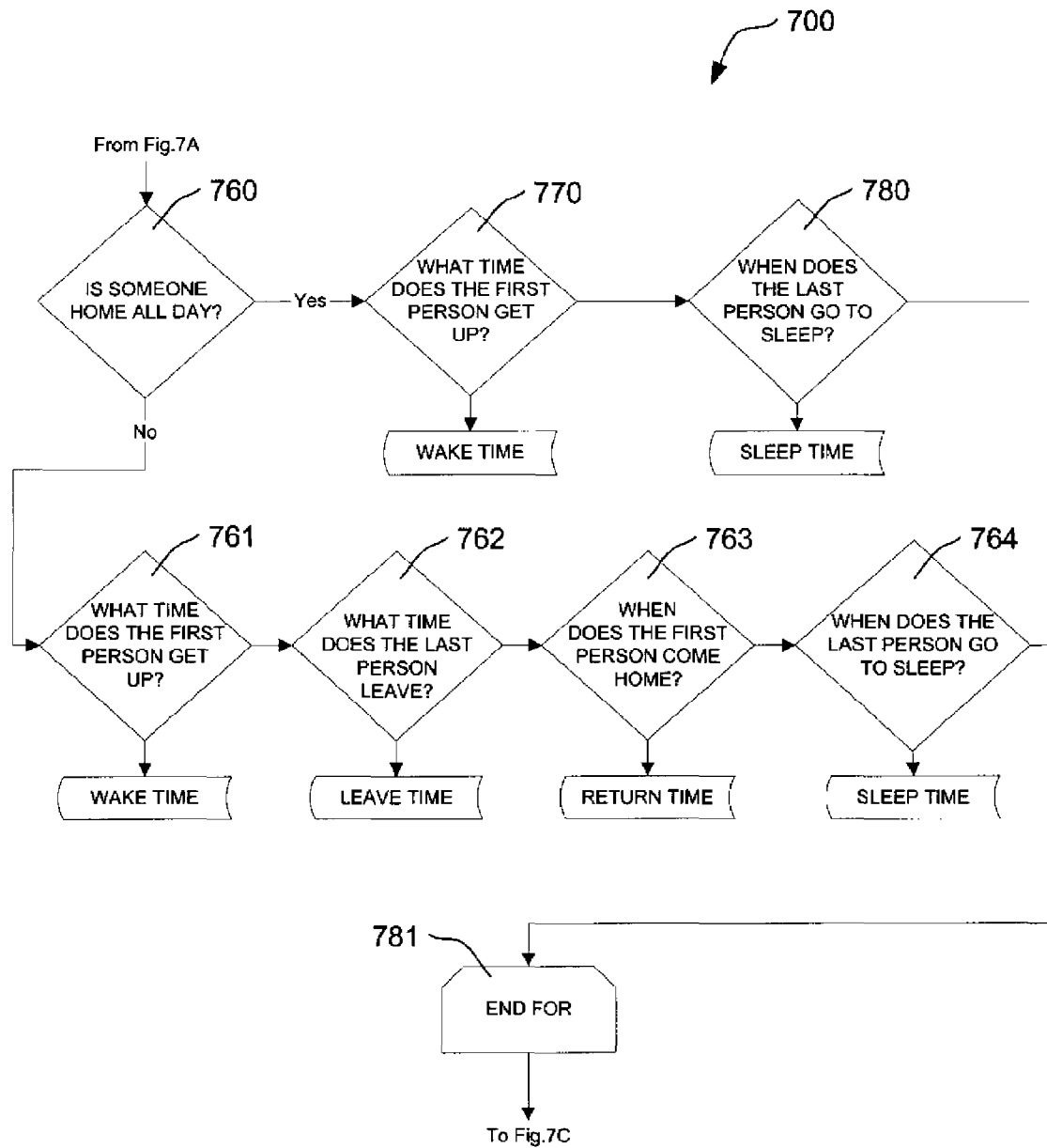

Figure 7B

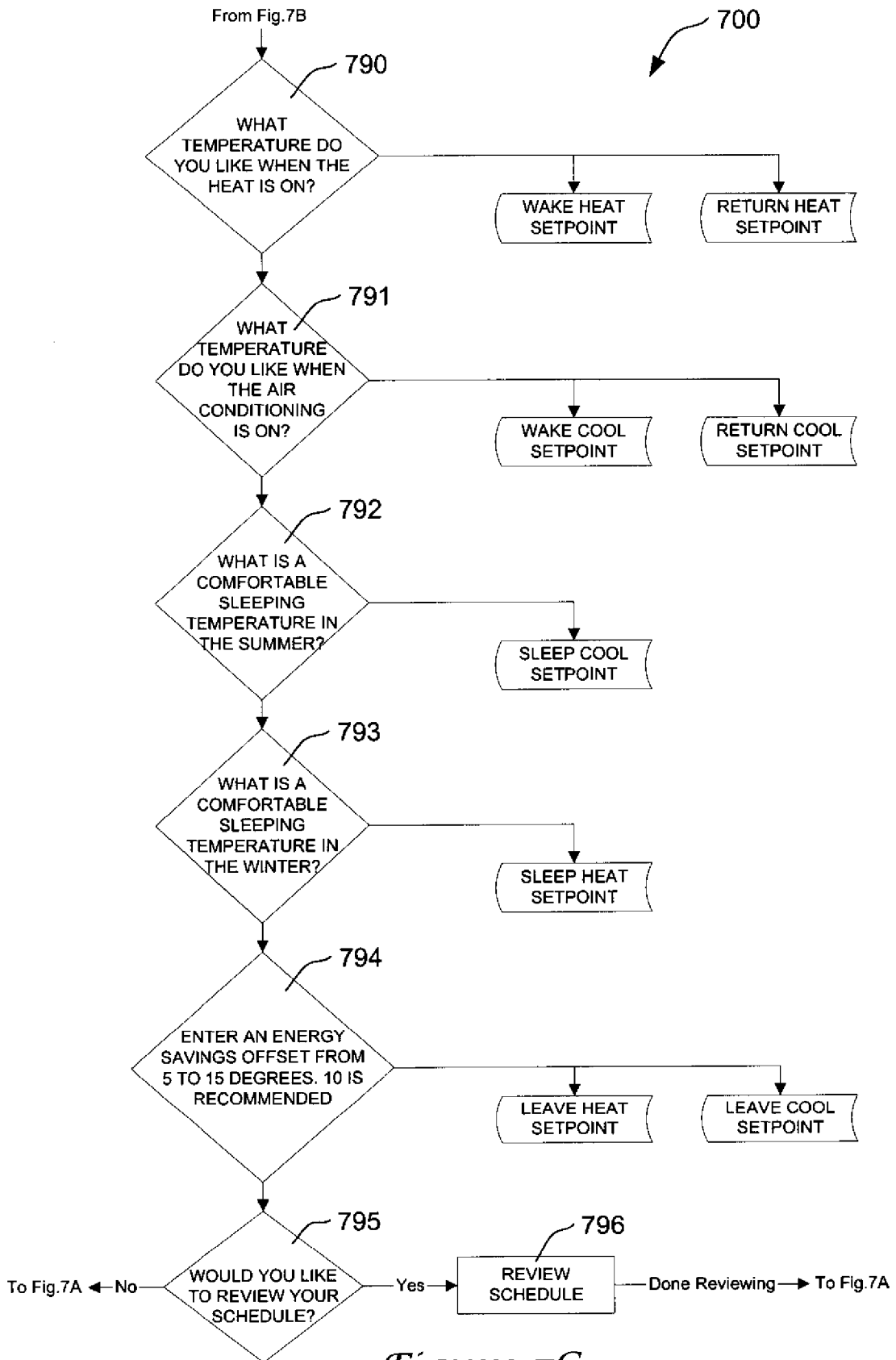

Figure 7C

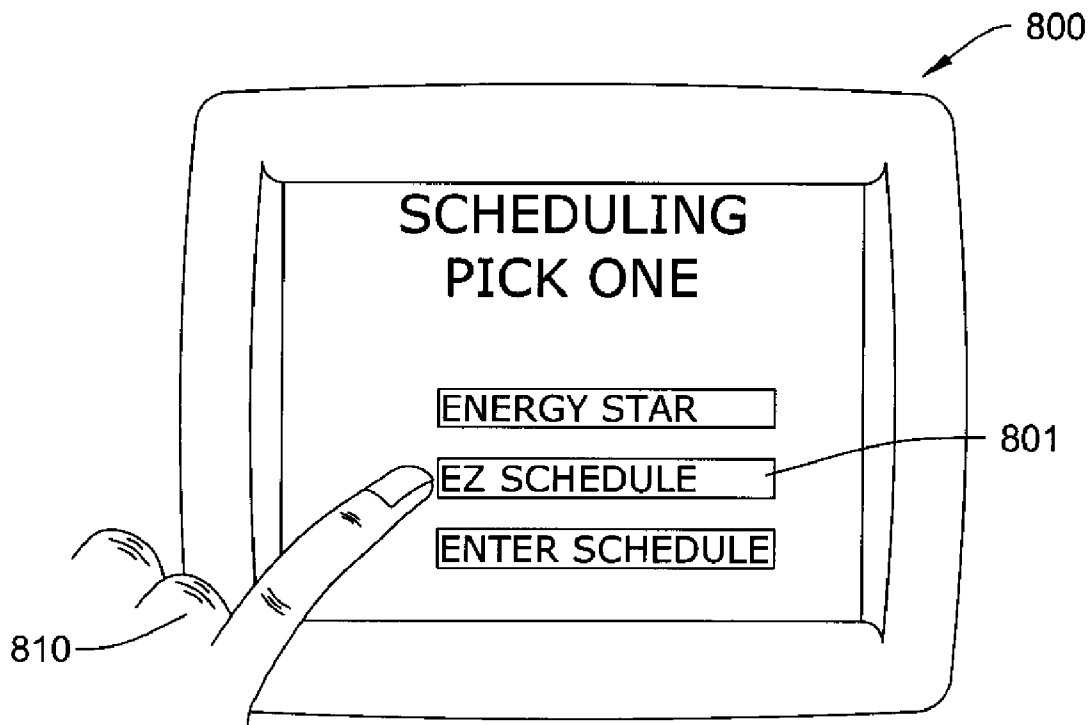

Figure 8A

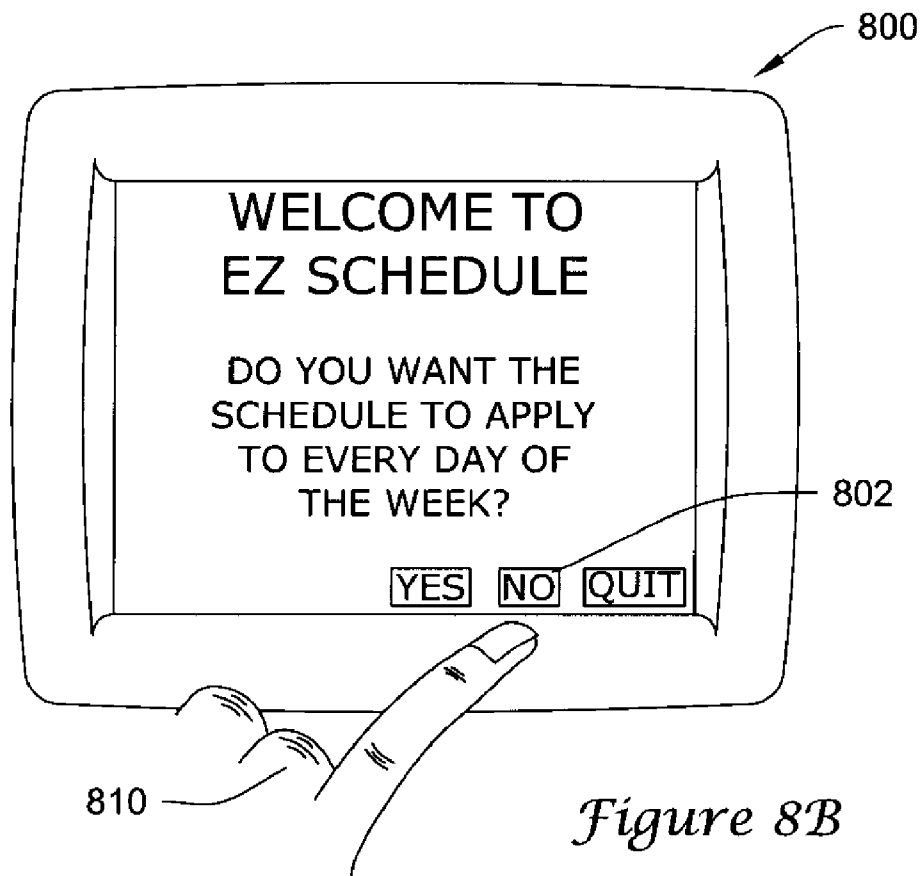
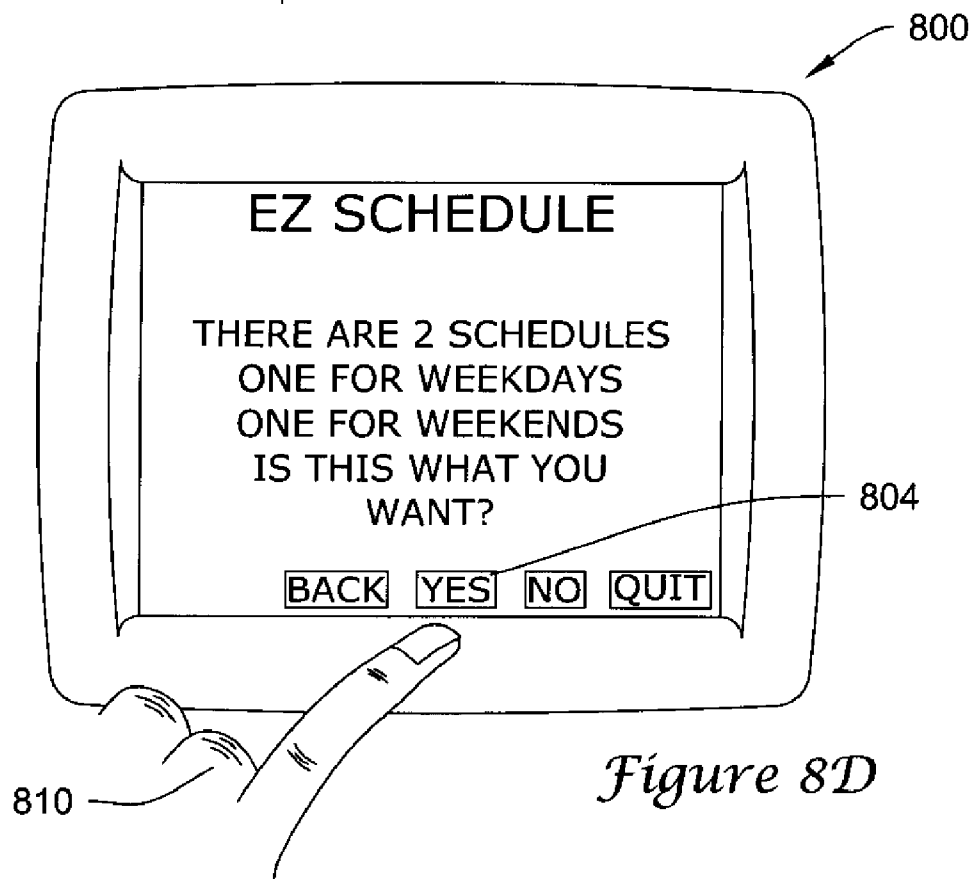
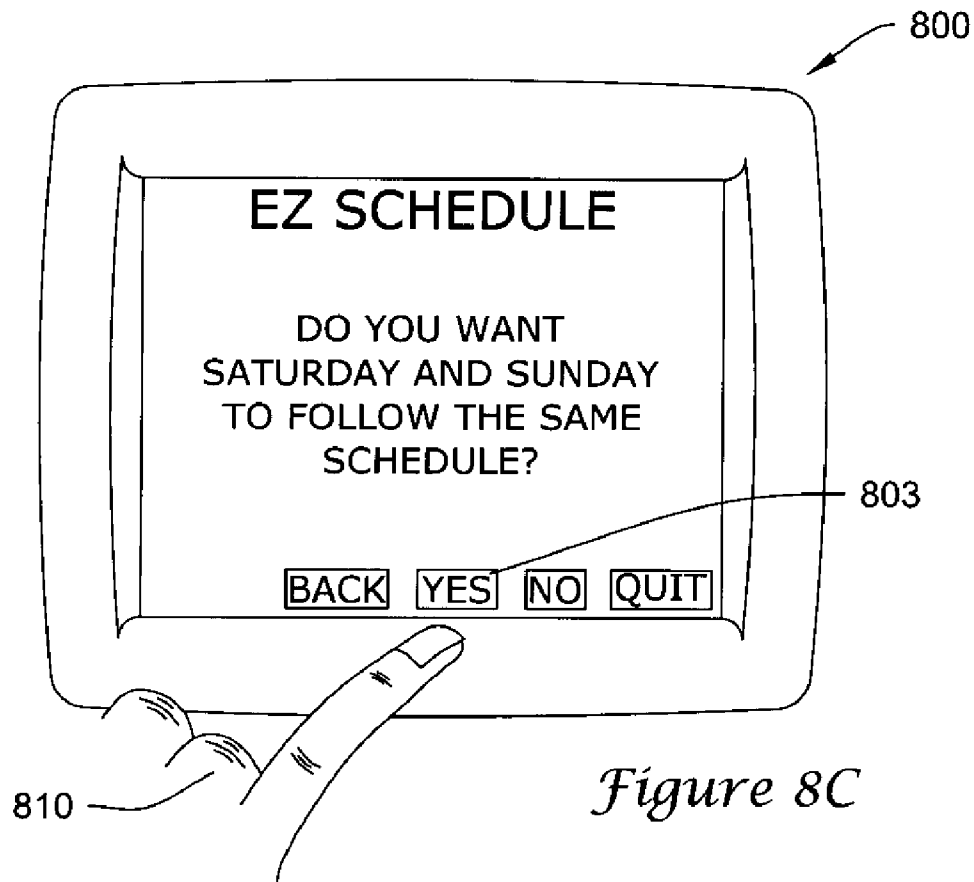
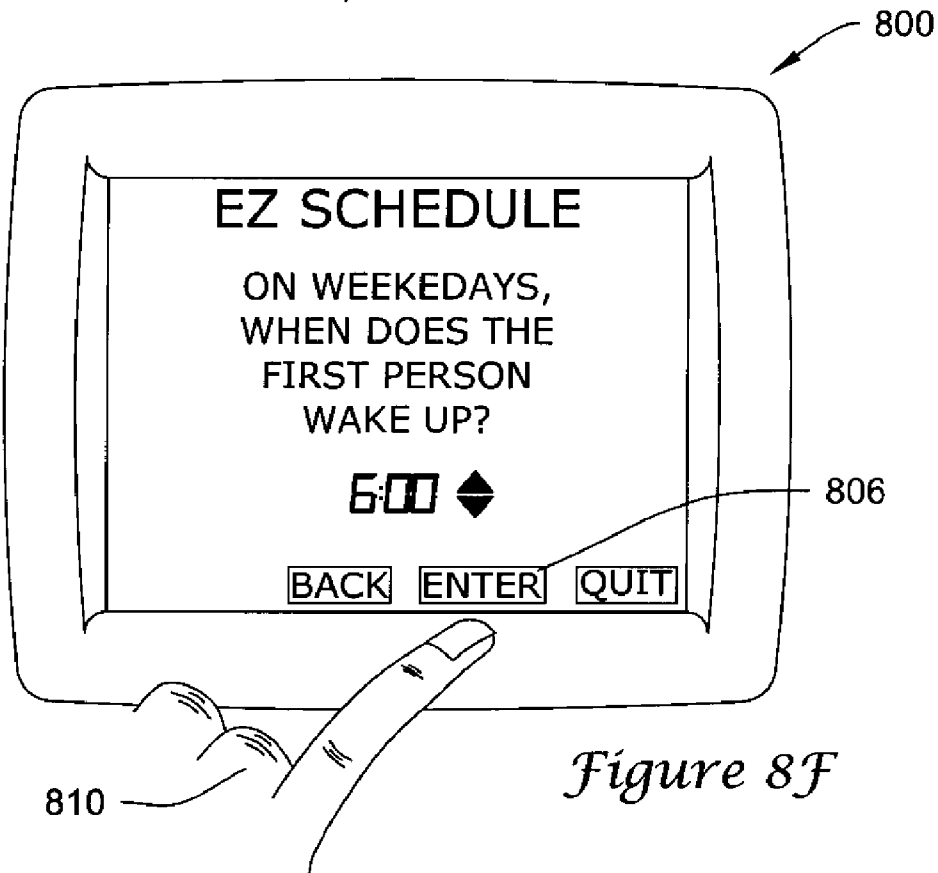
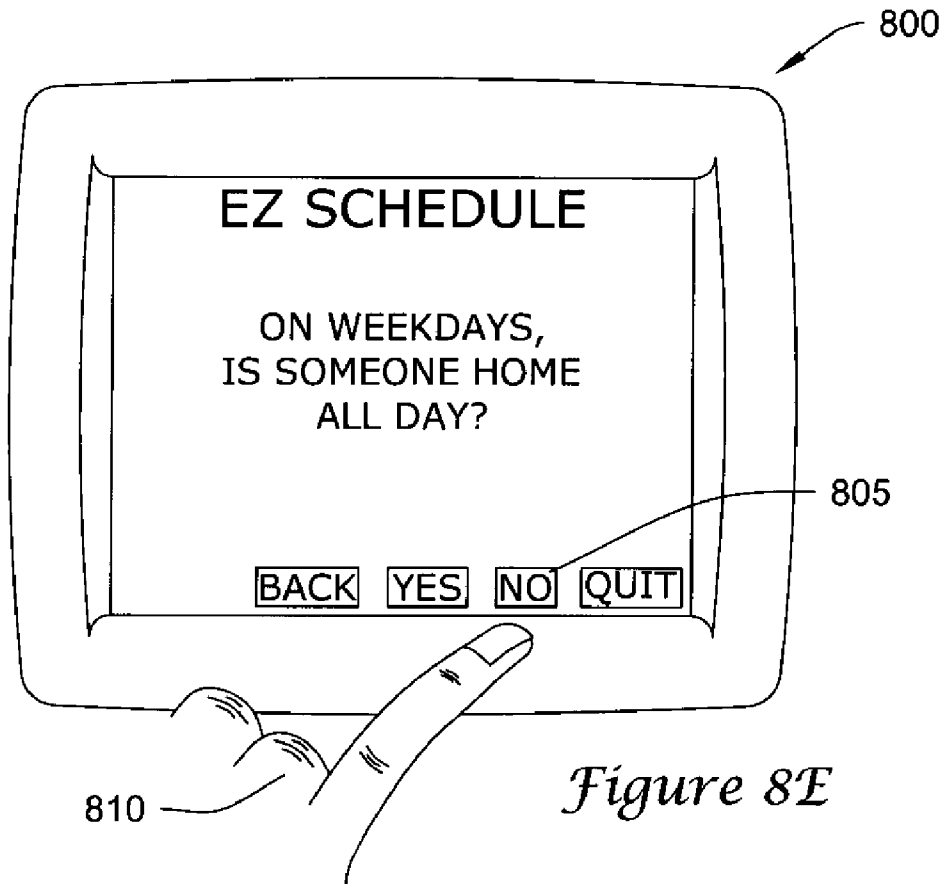

Figure 8B





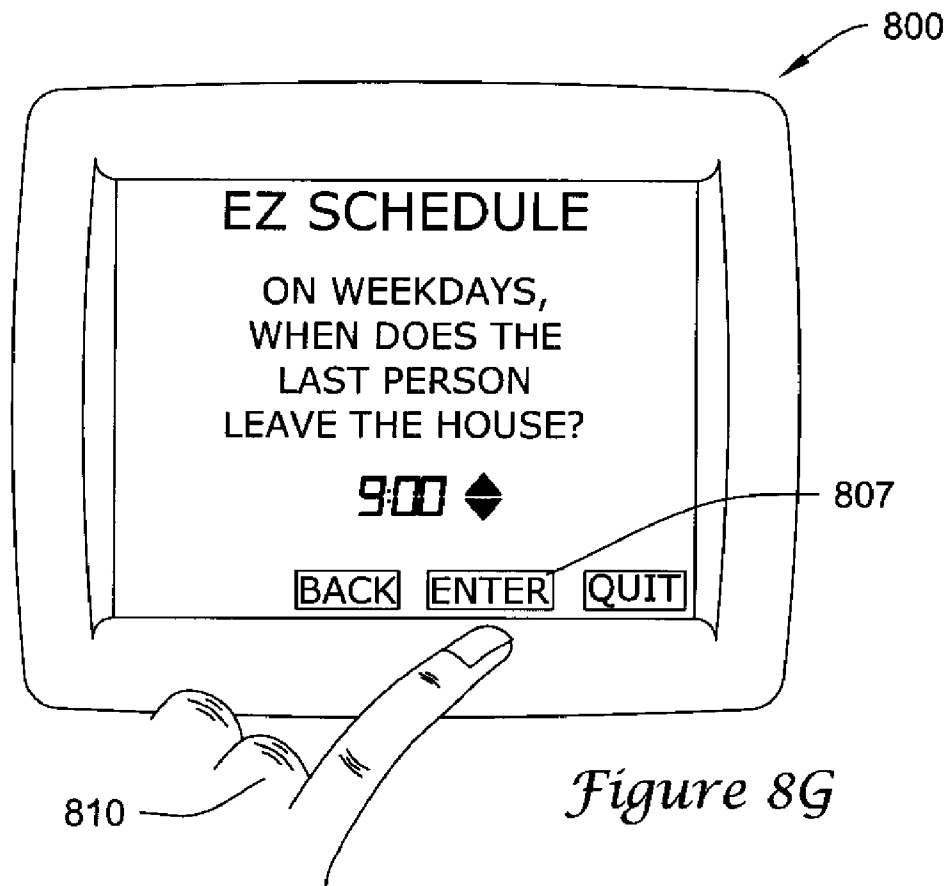

Figure 8G

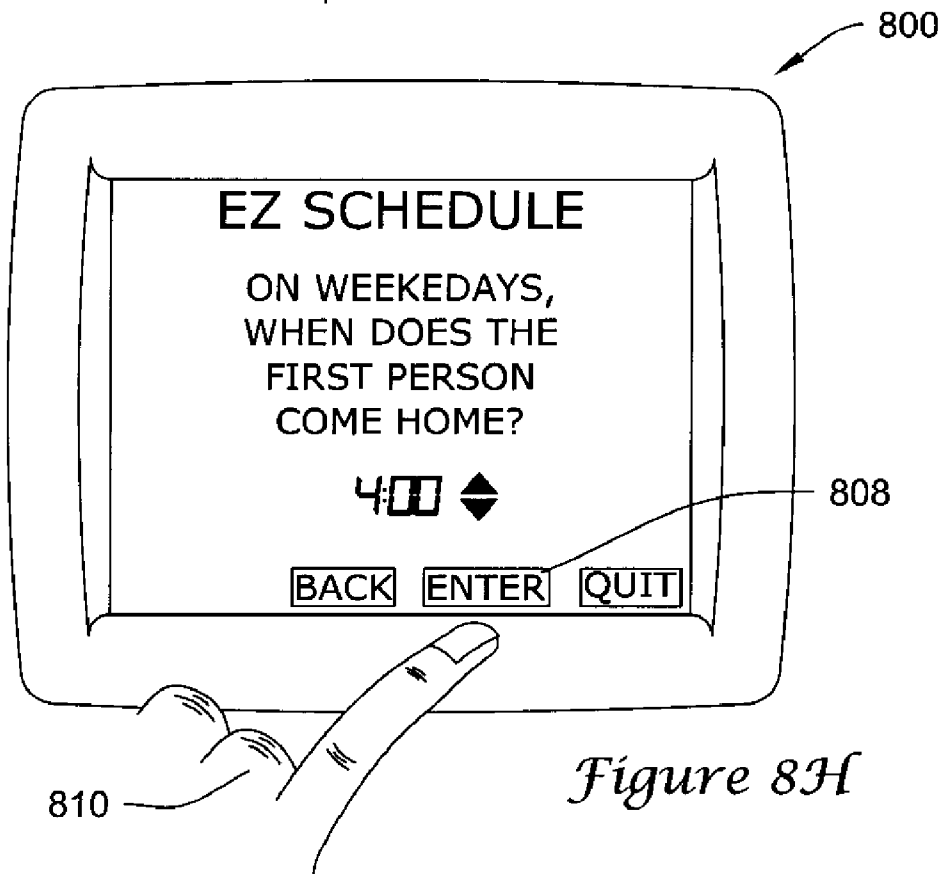
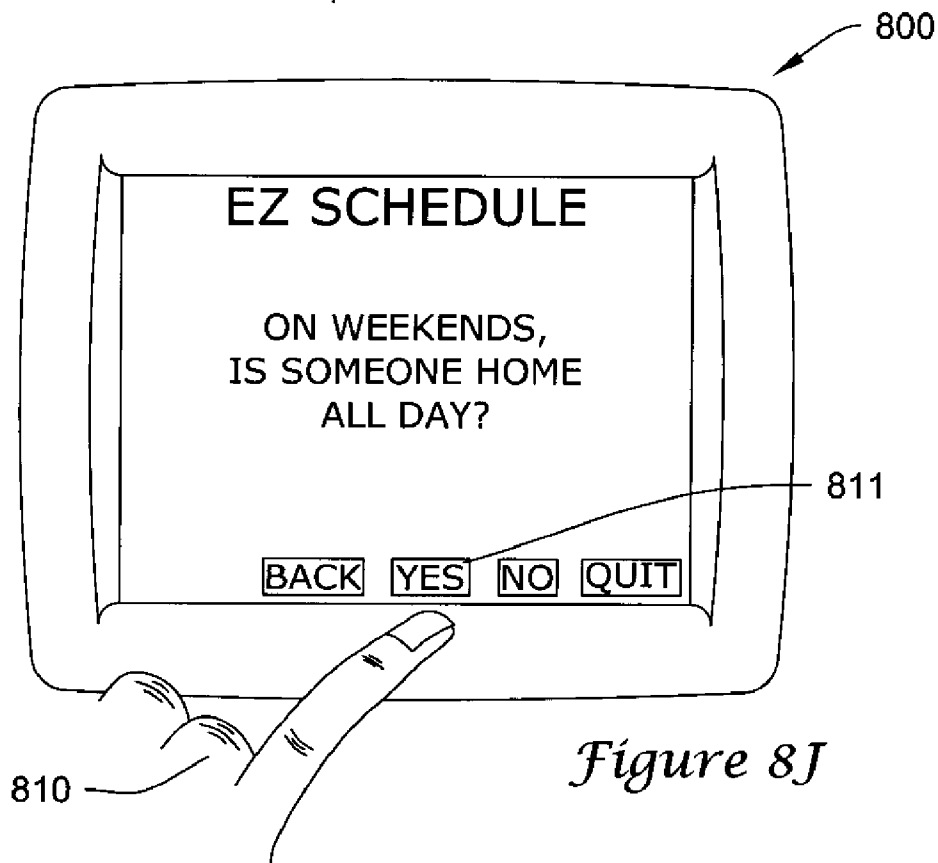
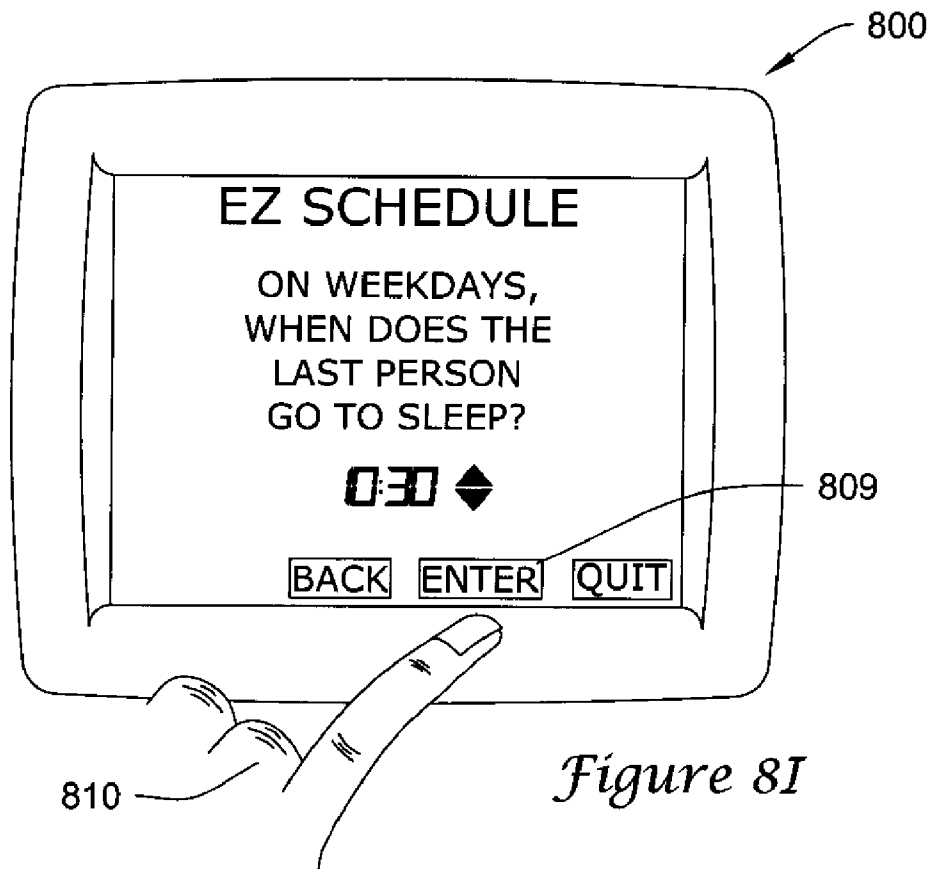

Figure 8H



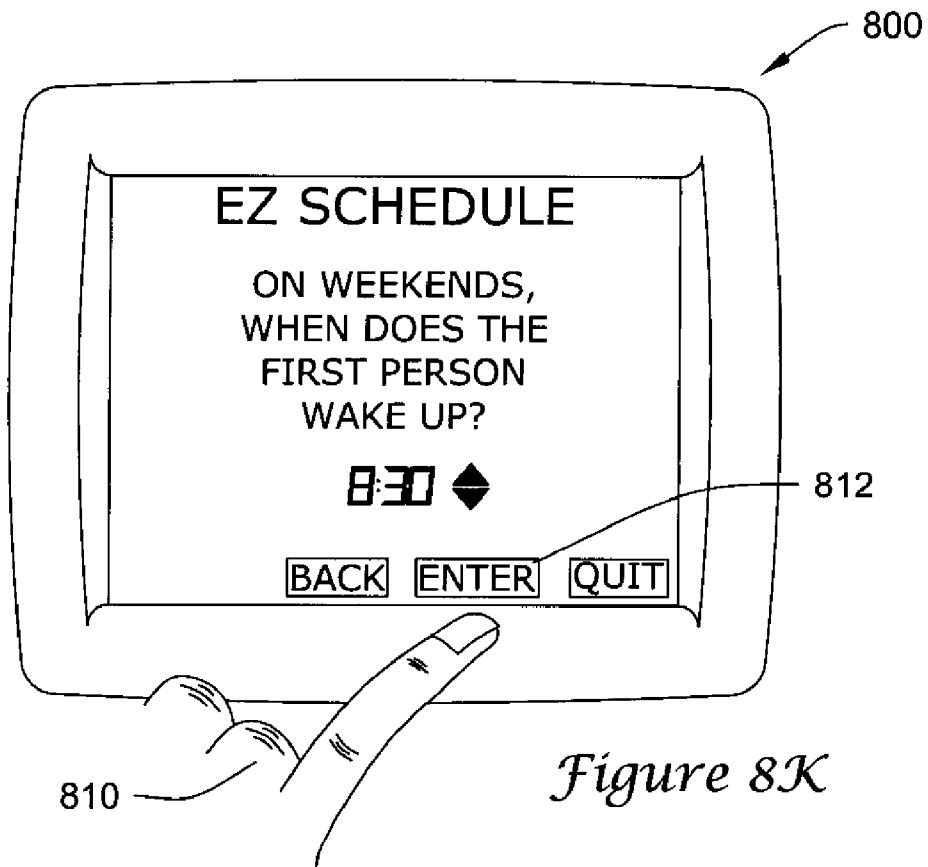

Figure 8K

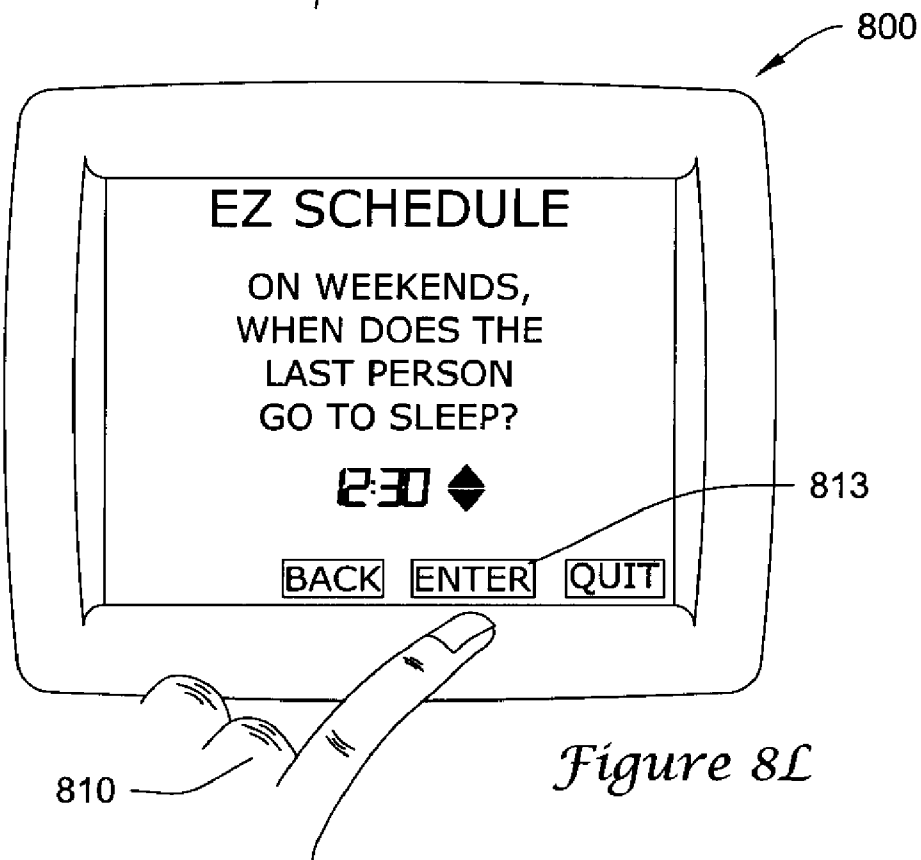

Figure 8L

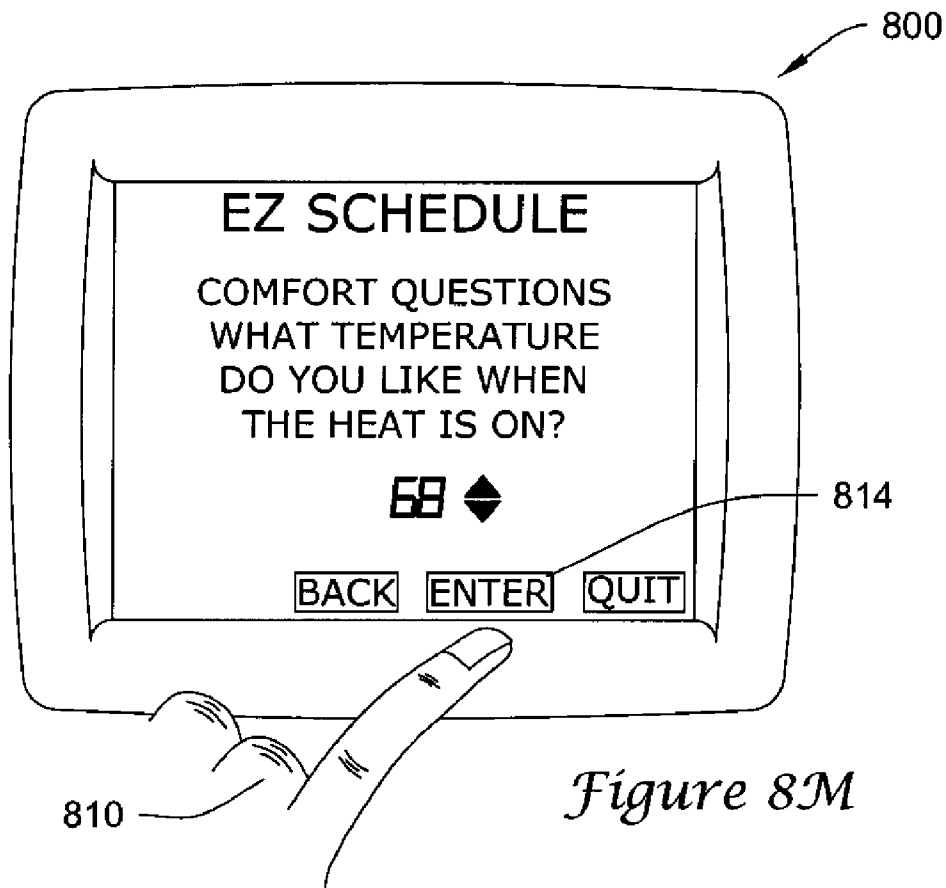

Figure 8M

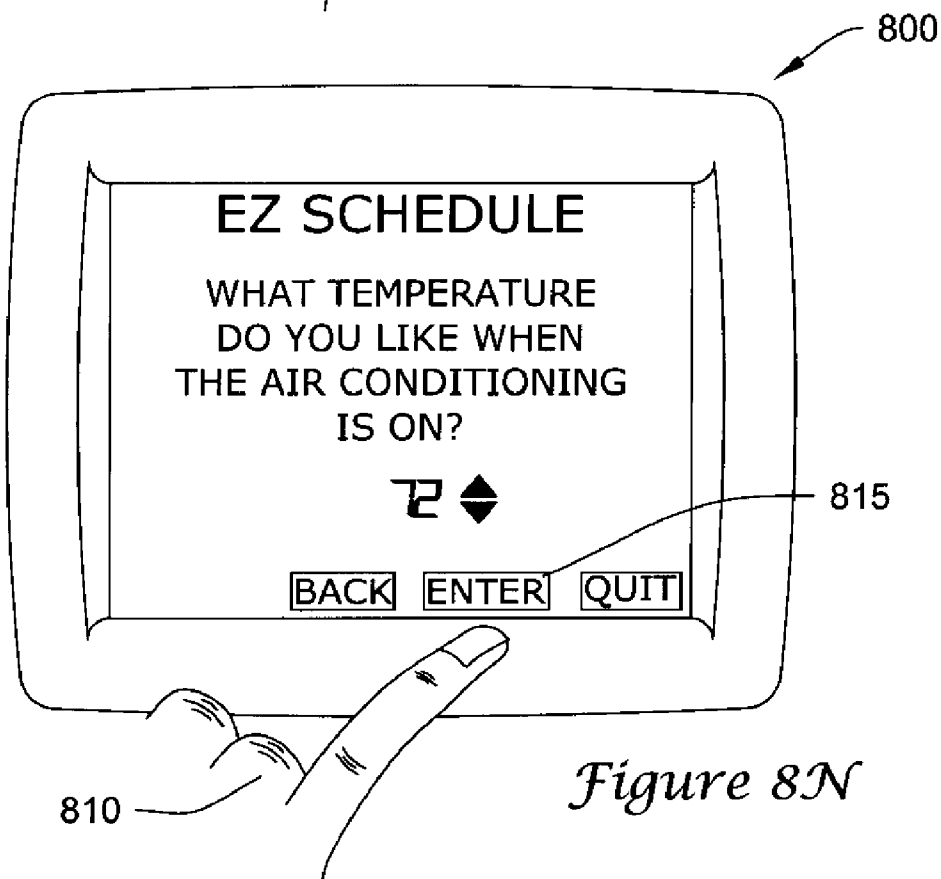
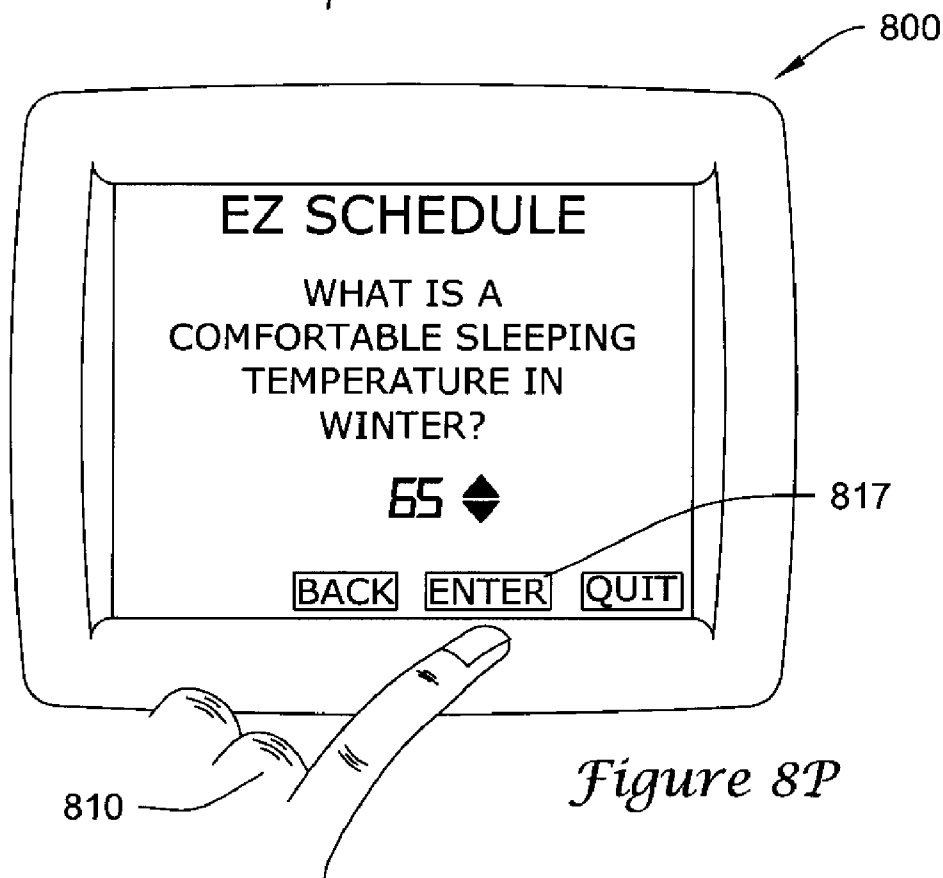
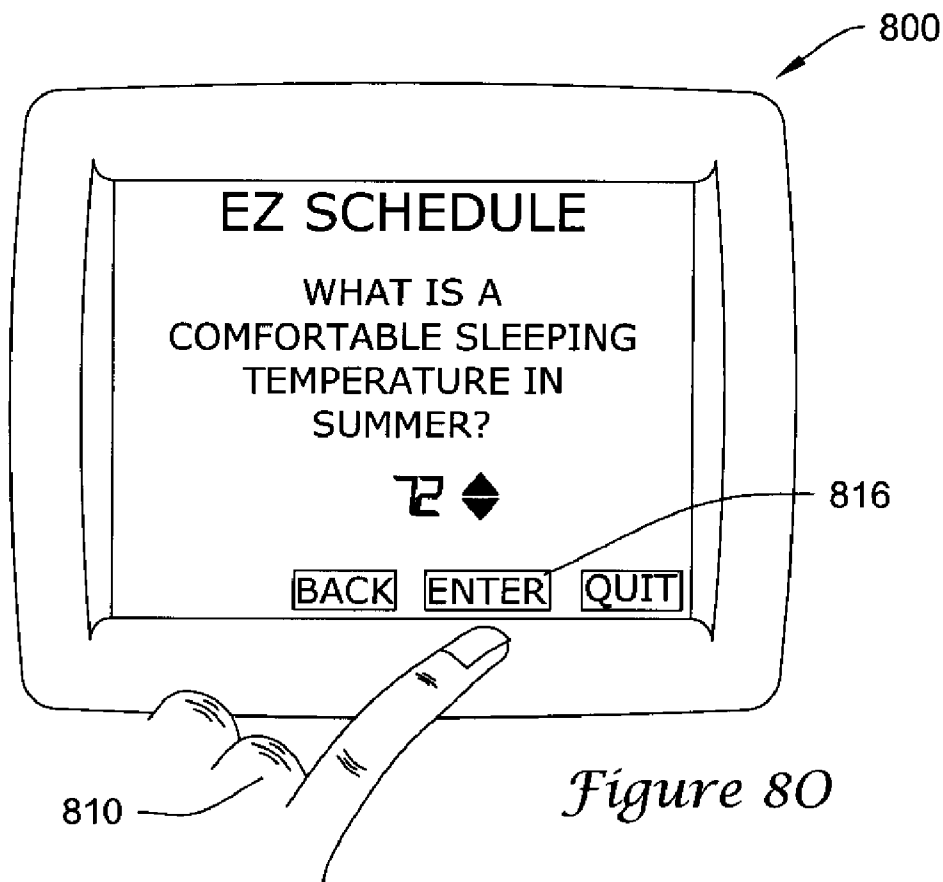
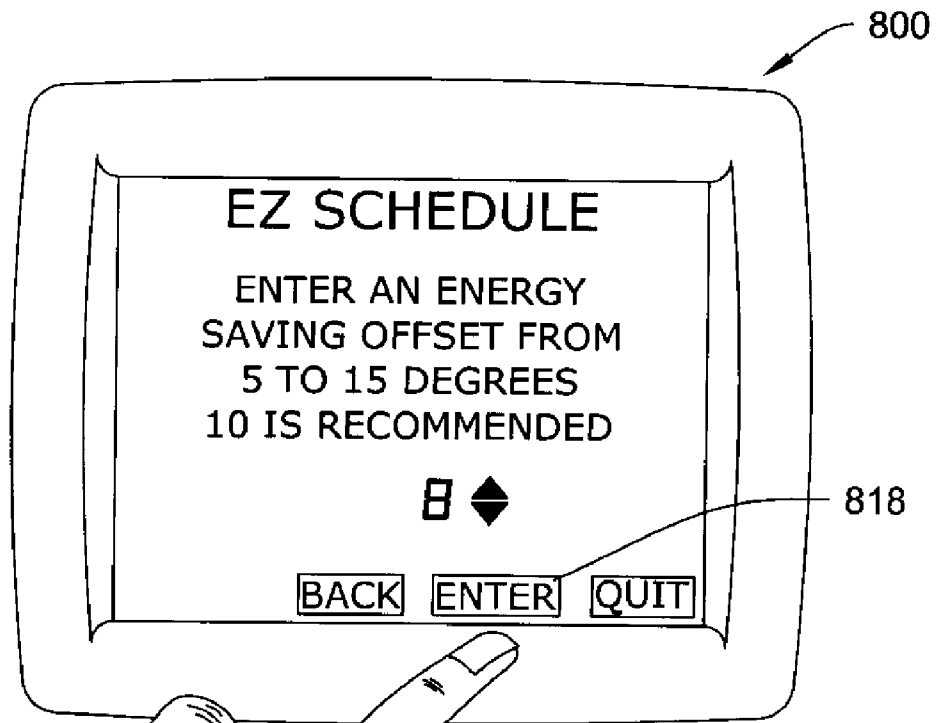
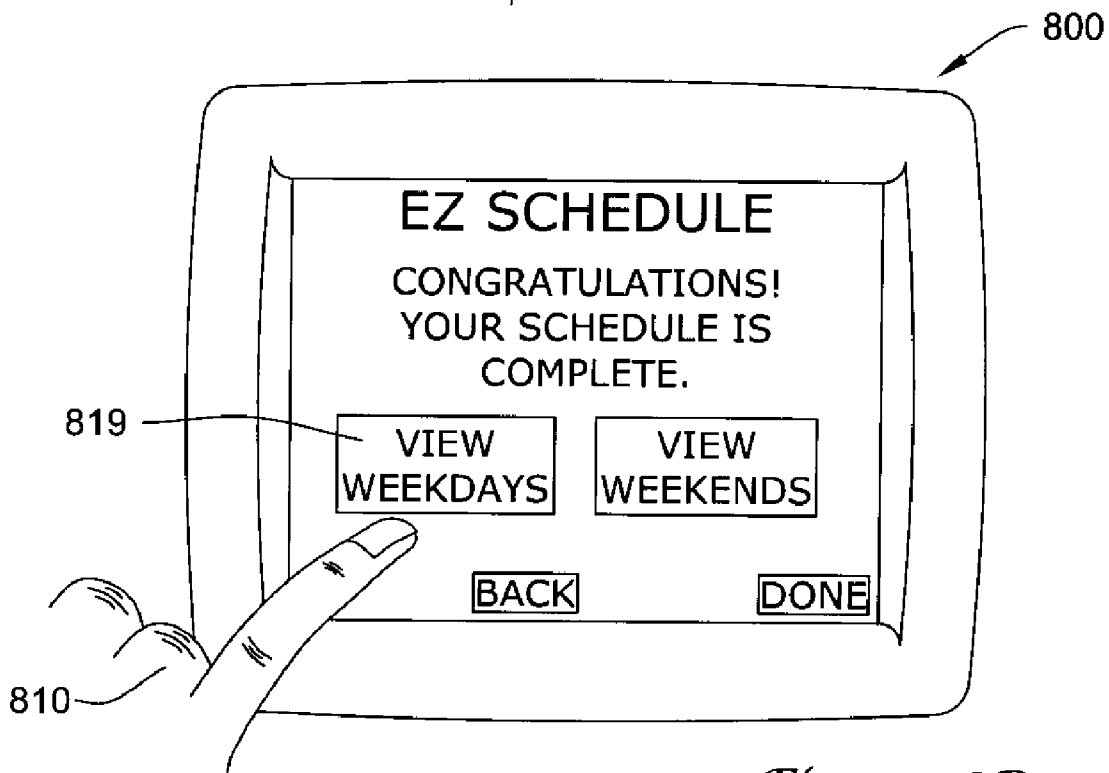

Figure 8N





810 *Figure 8Q*



810 *Figure 8R*

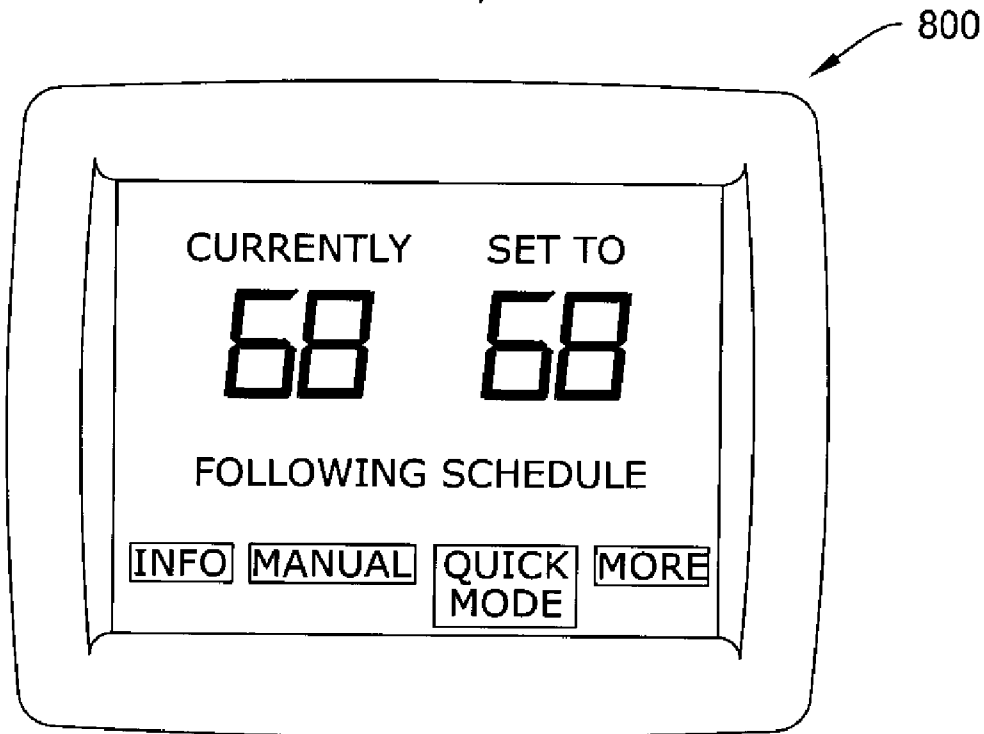
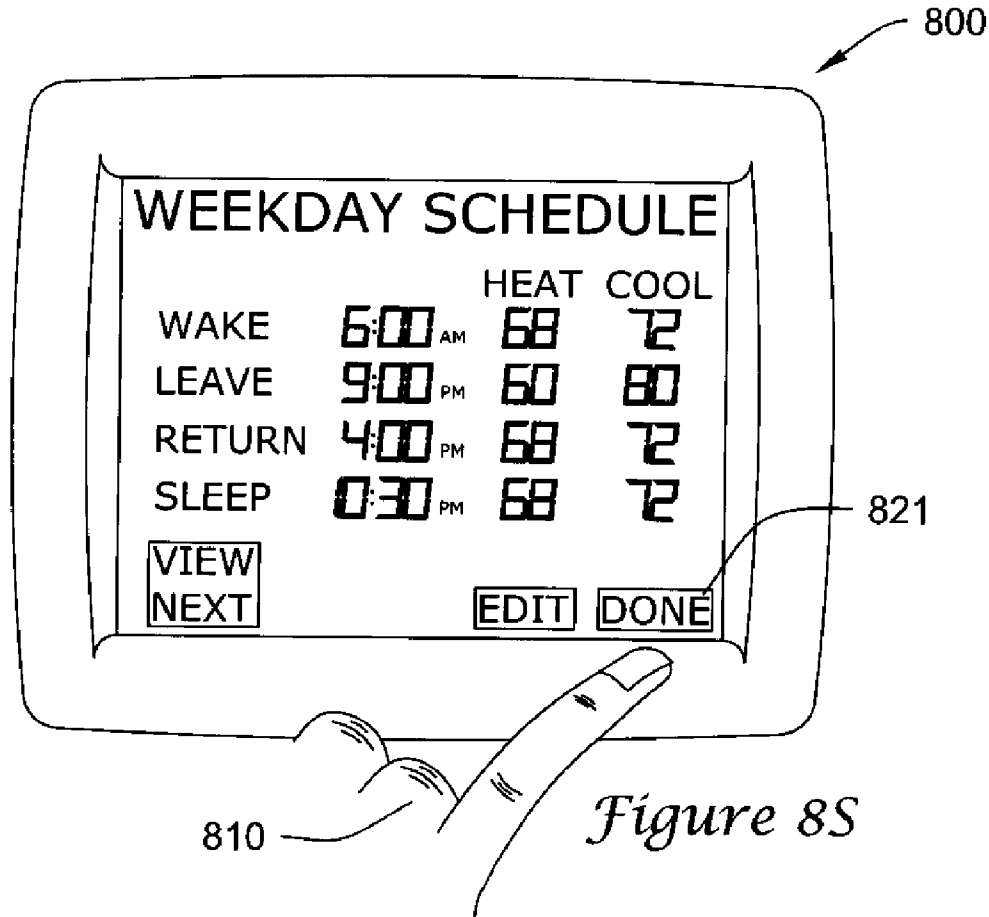

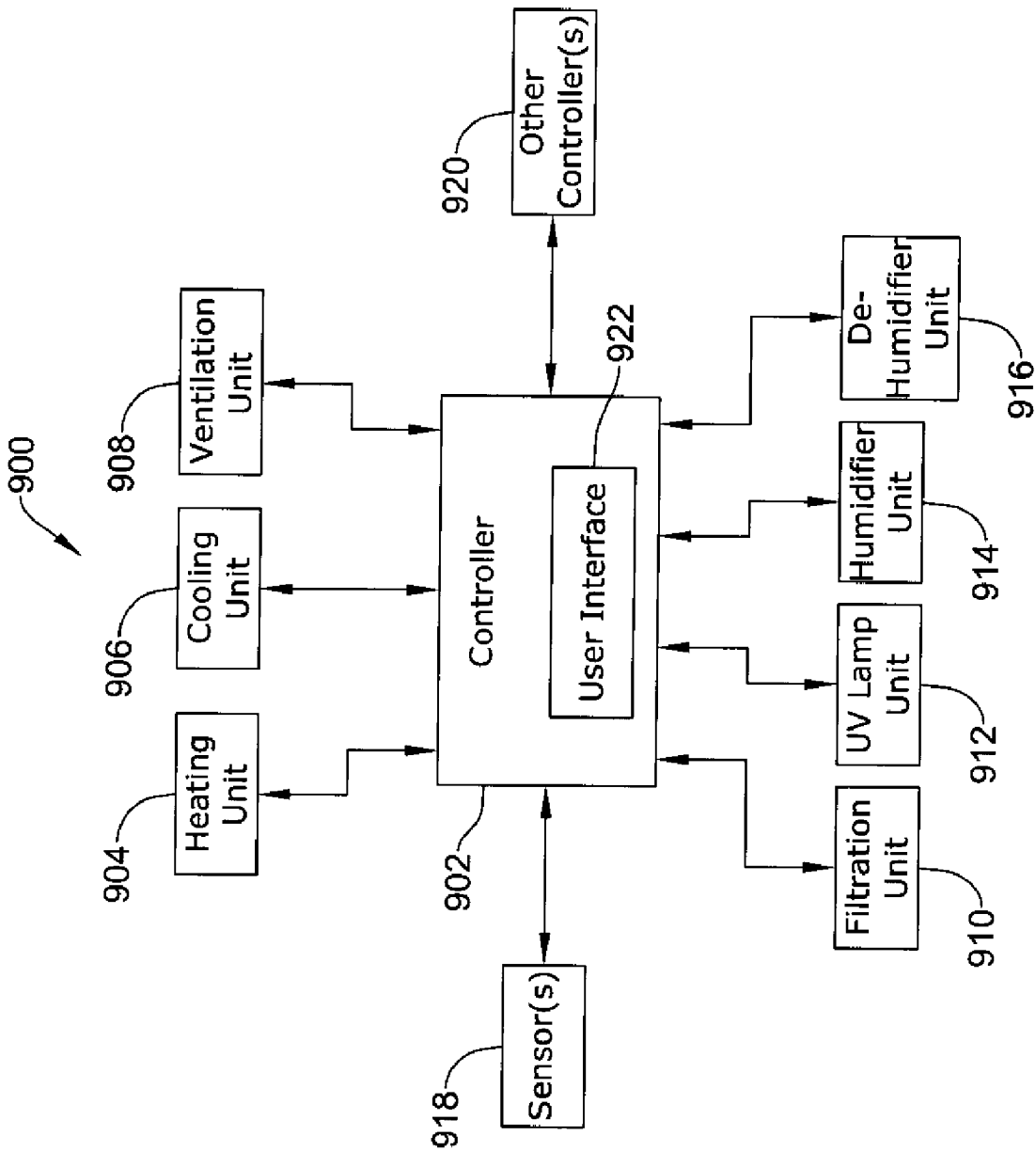

Figure 9

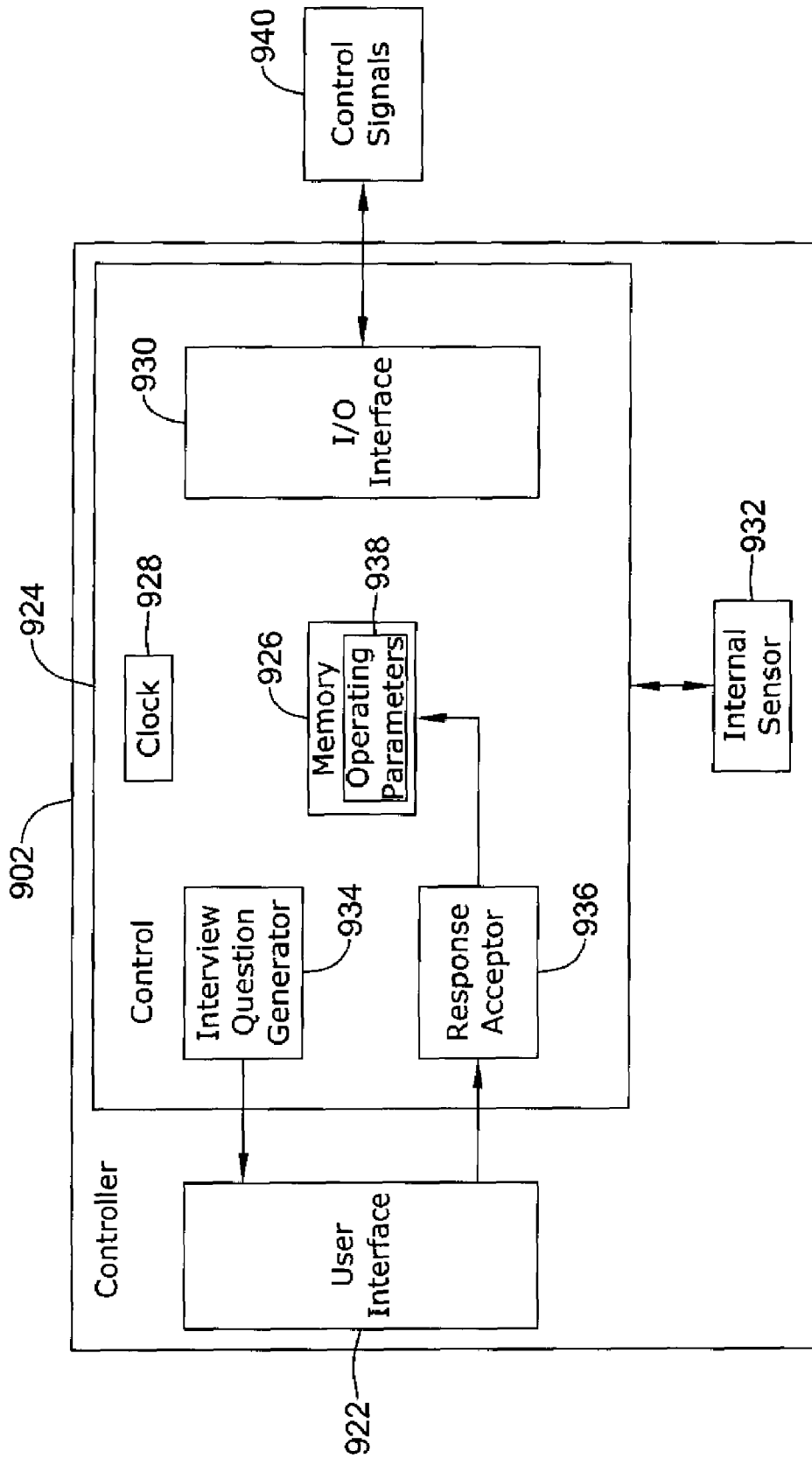

Figure 10

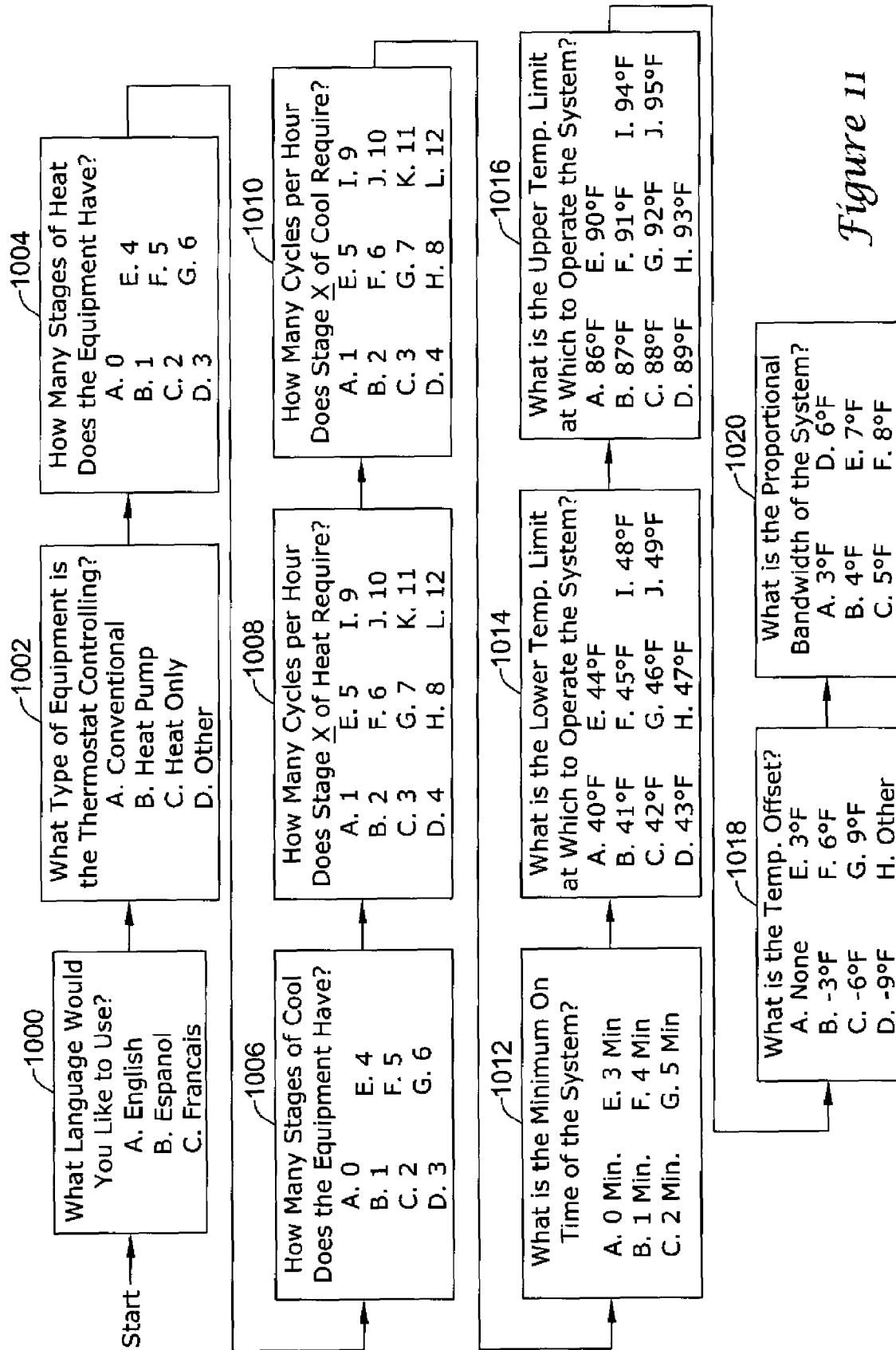

Figure 11

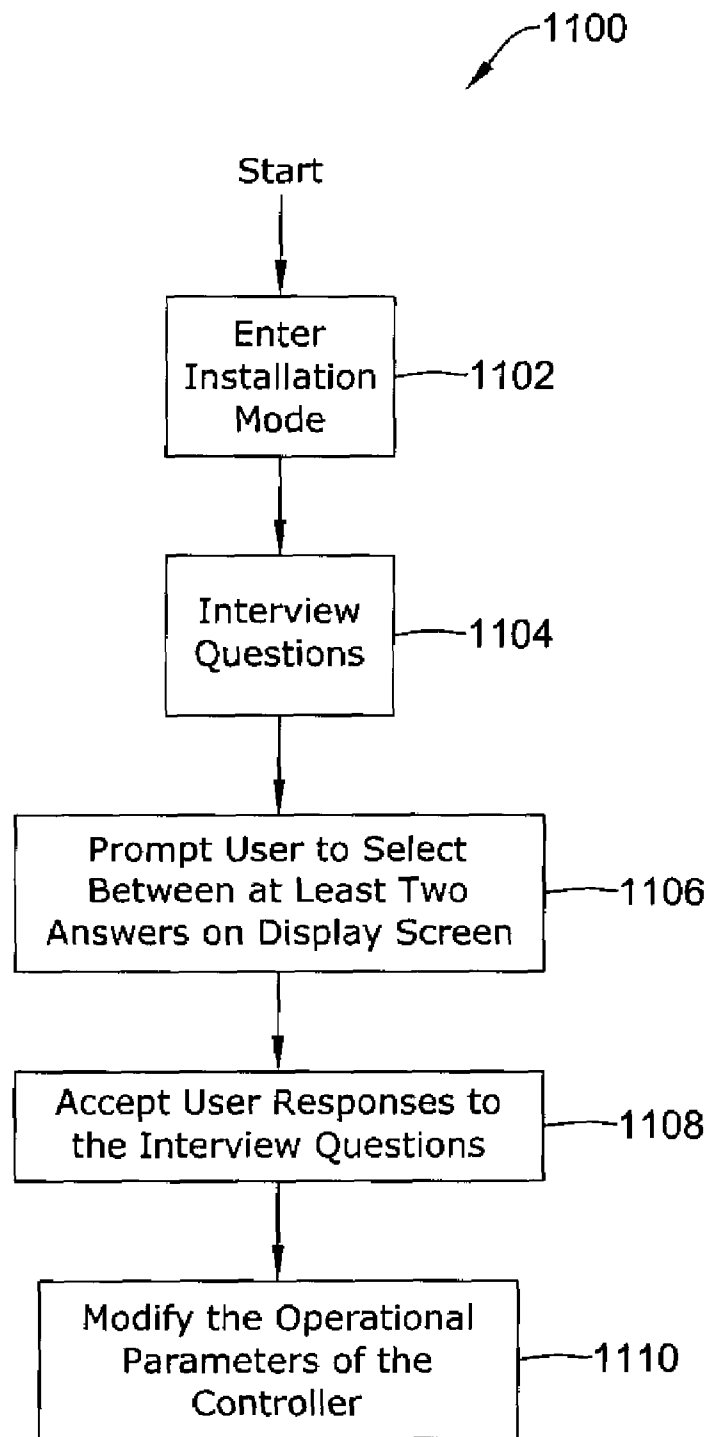

Figure 12

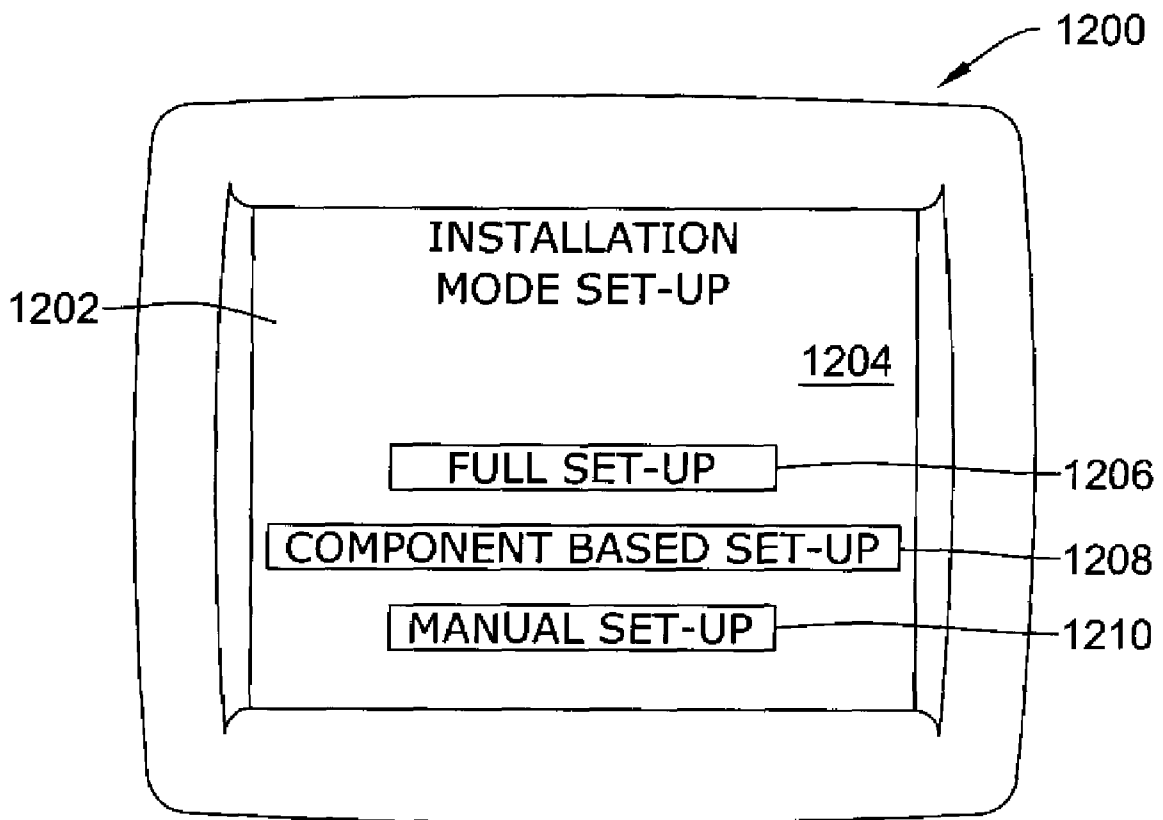

Figure 13A

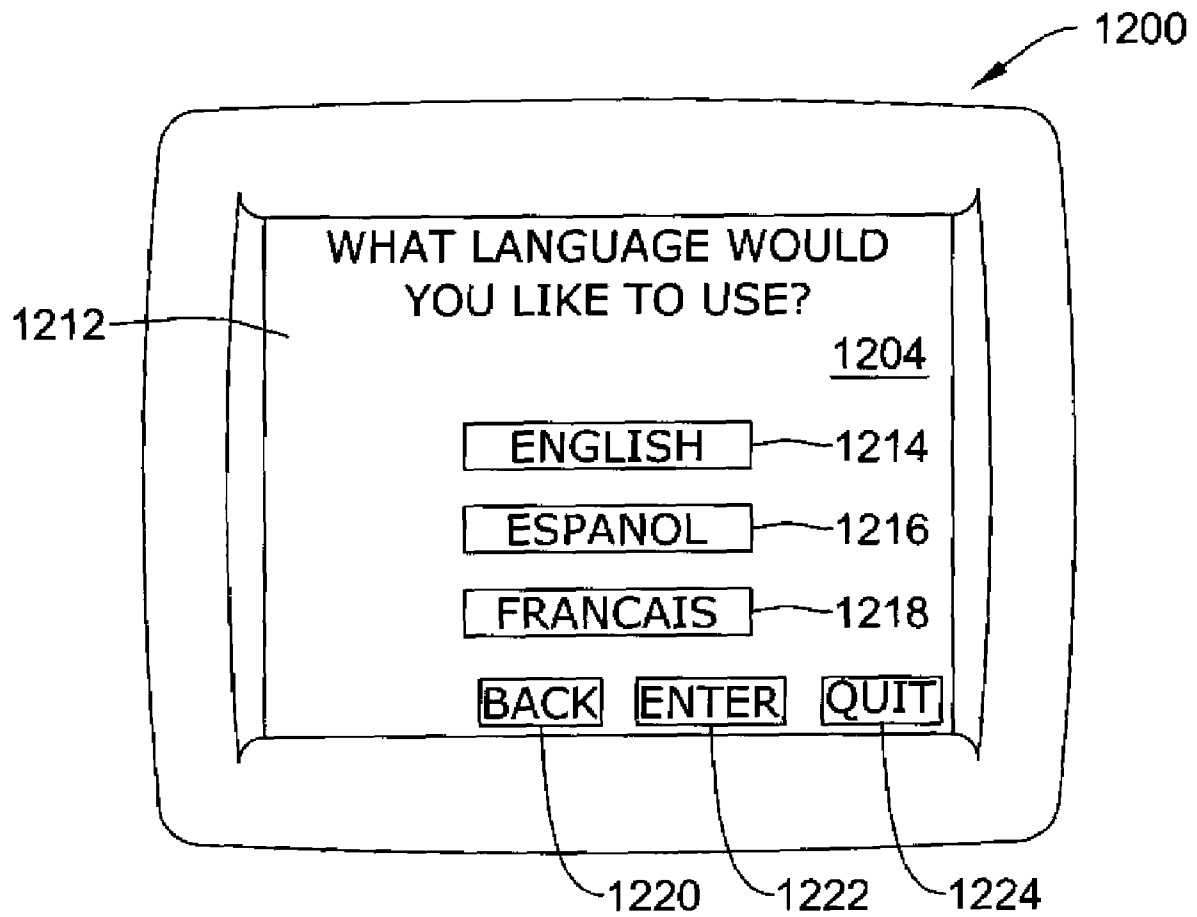

Figure 13B

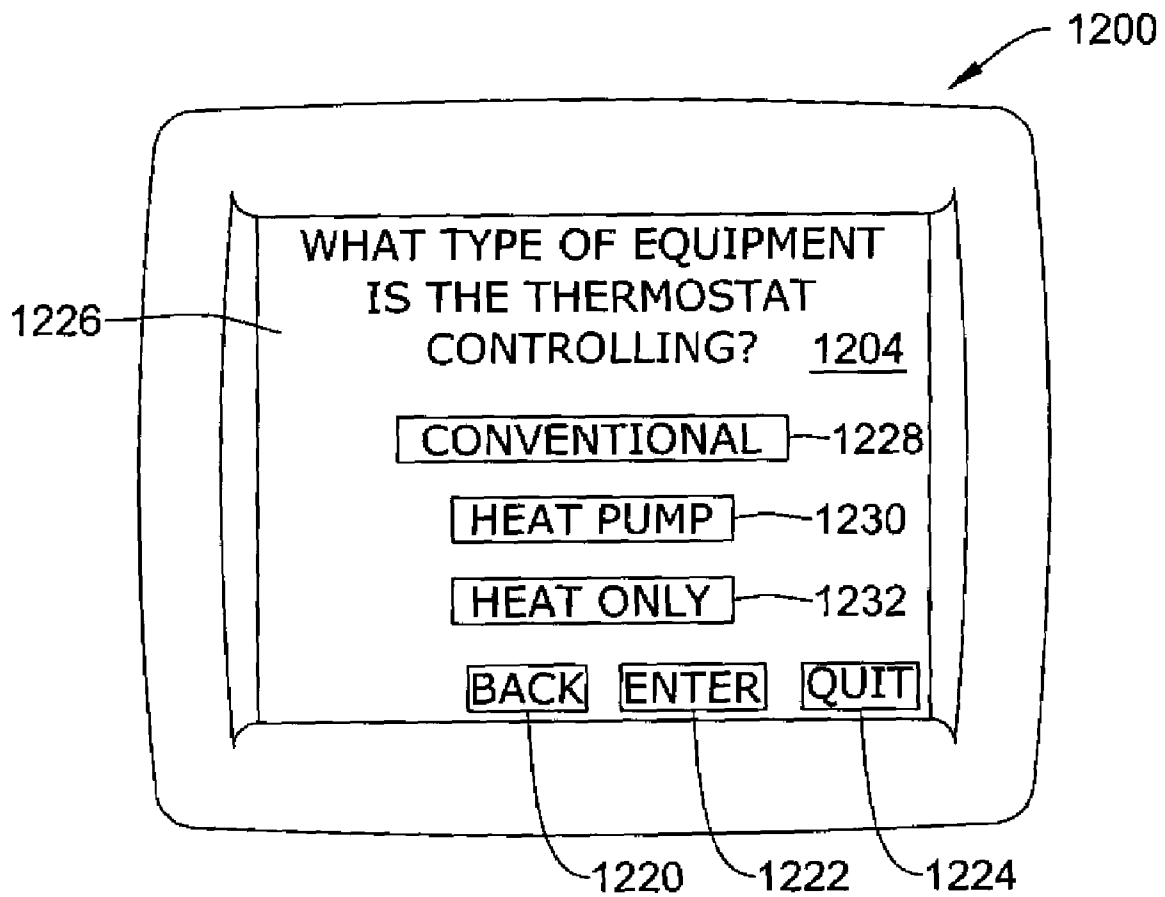

Figure 13C

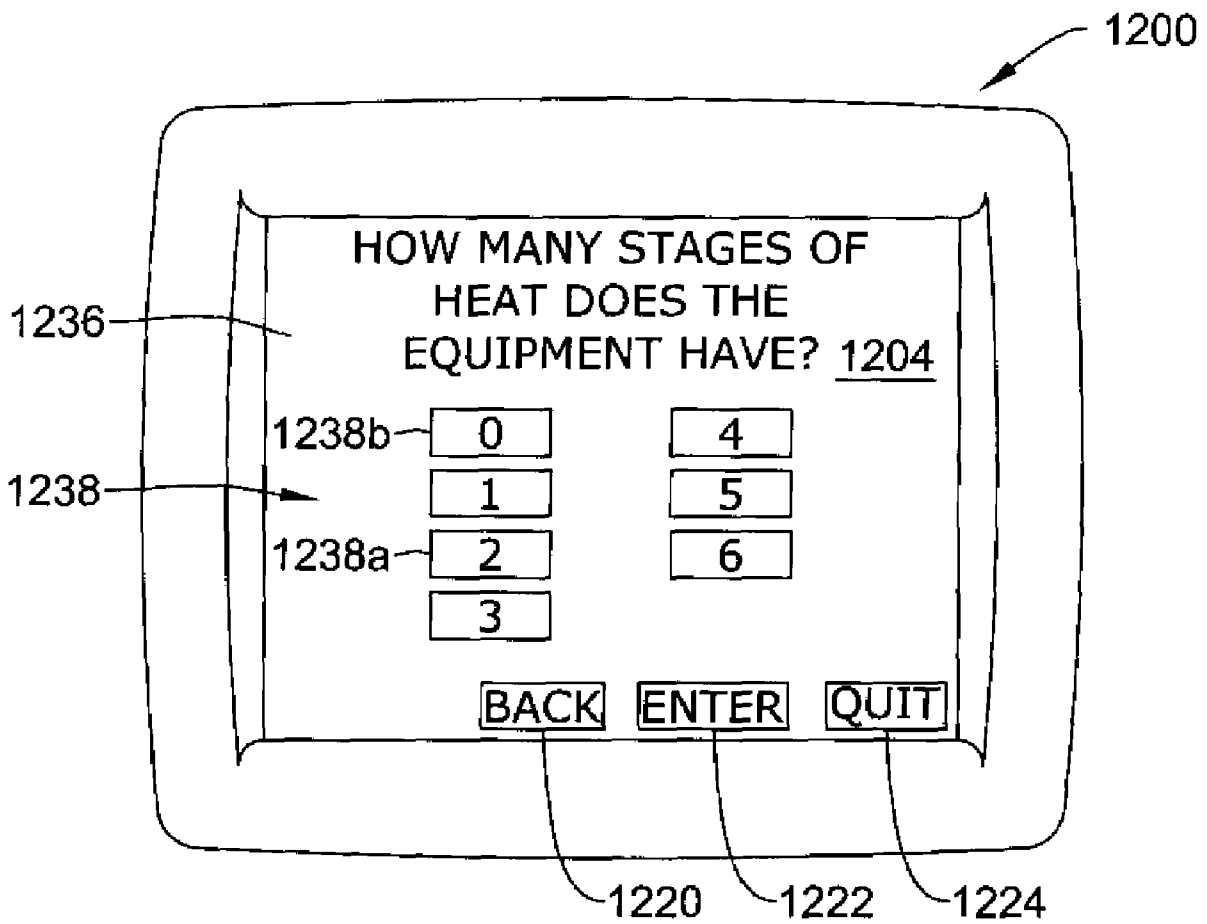

Figure 13D

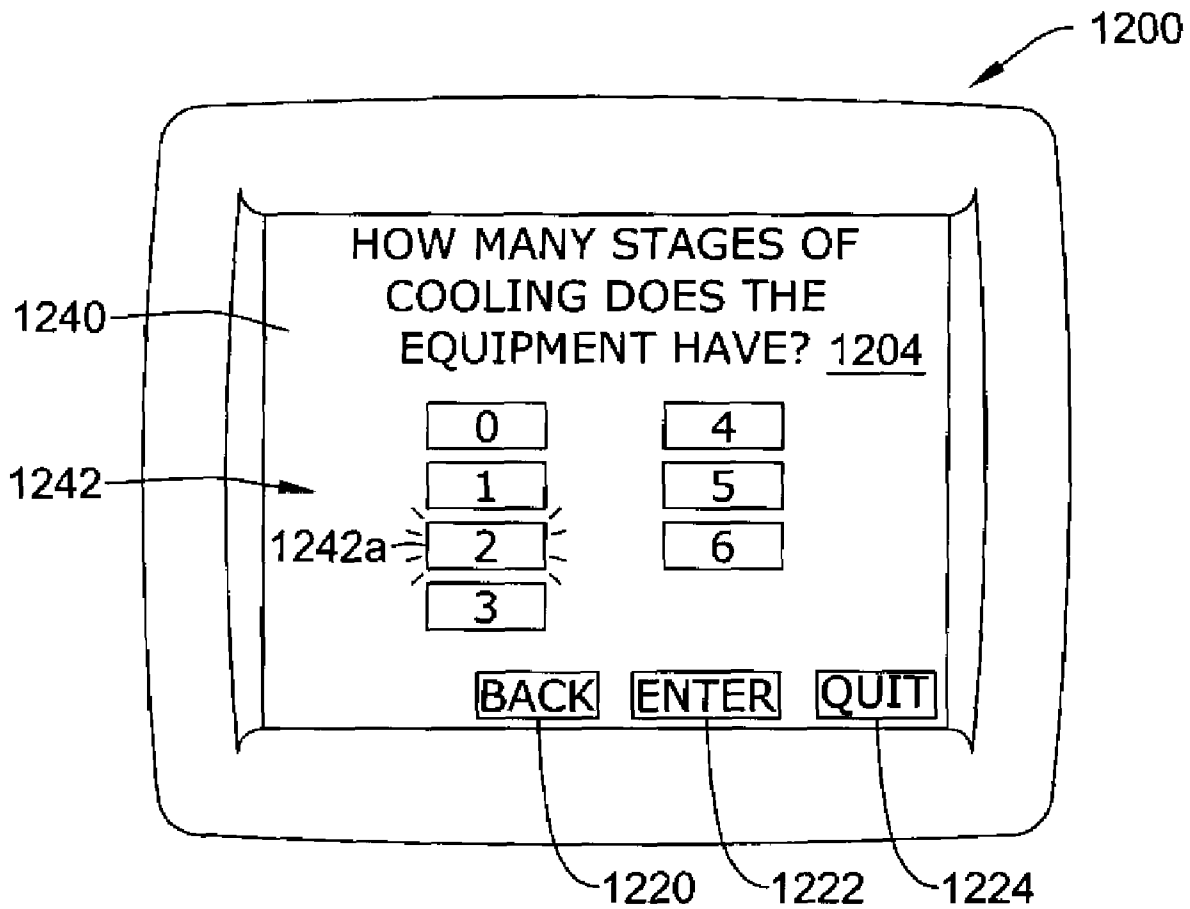

Figure 13E

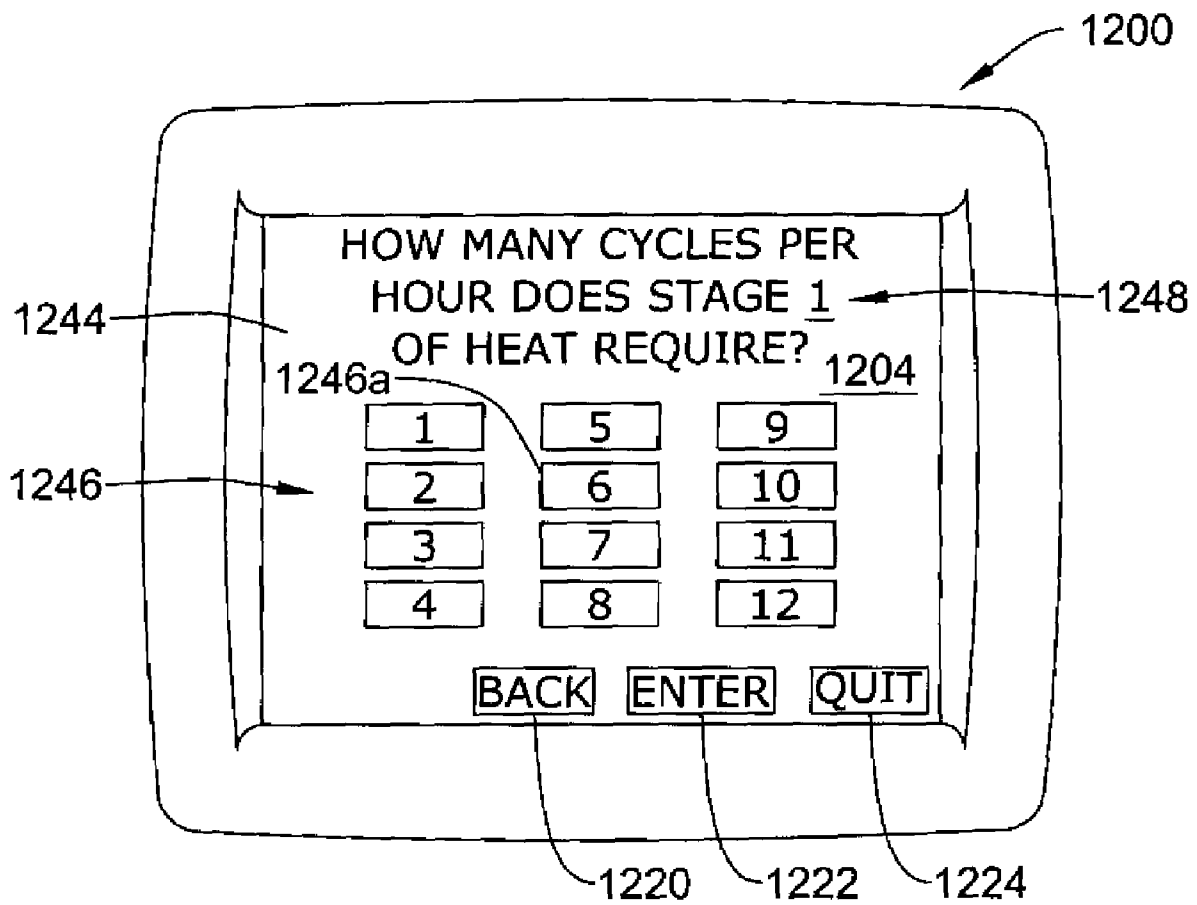

Figure 13F

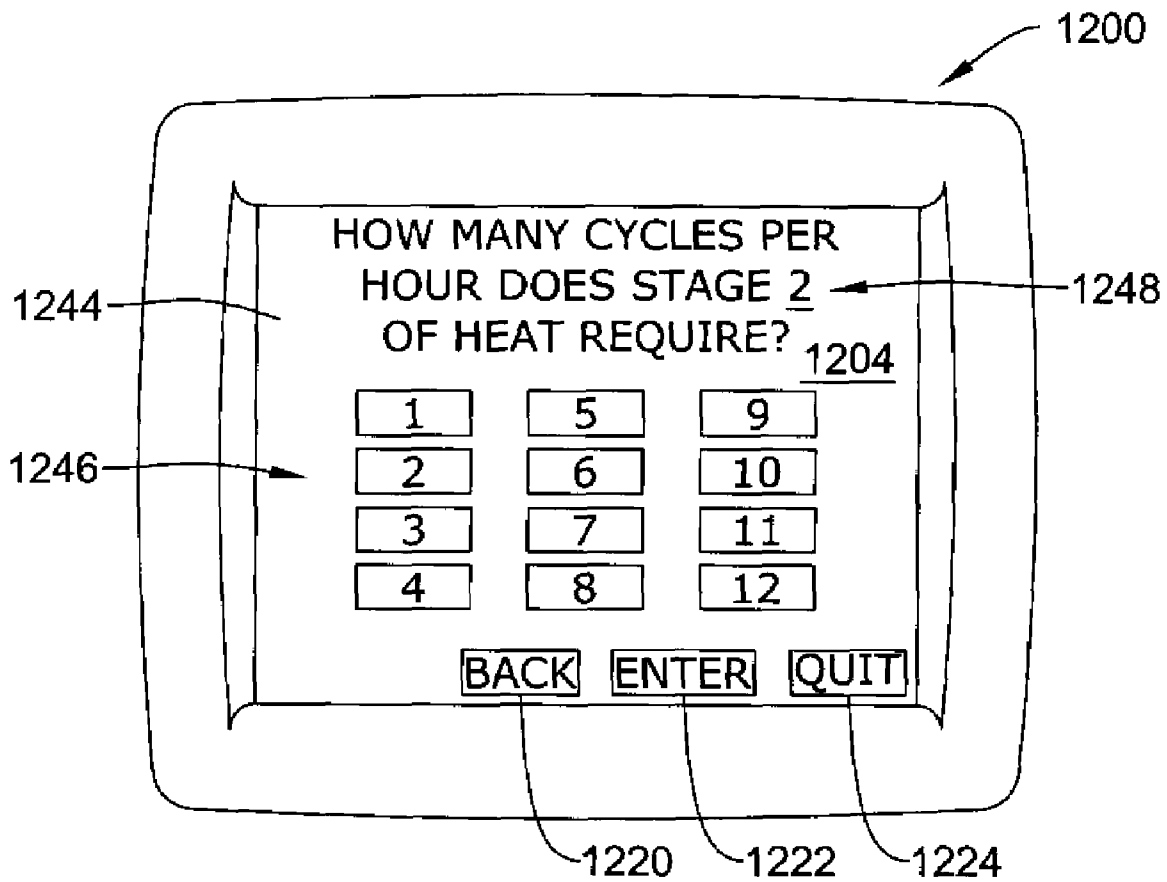

Figure 13G

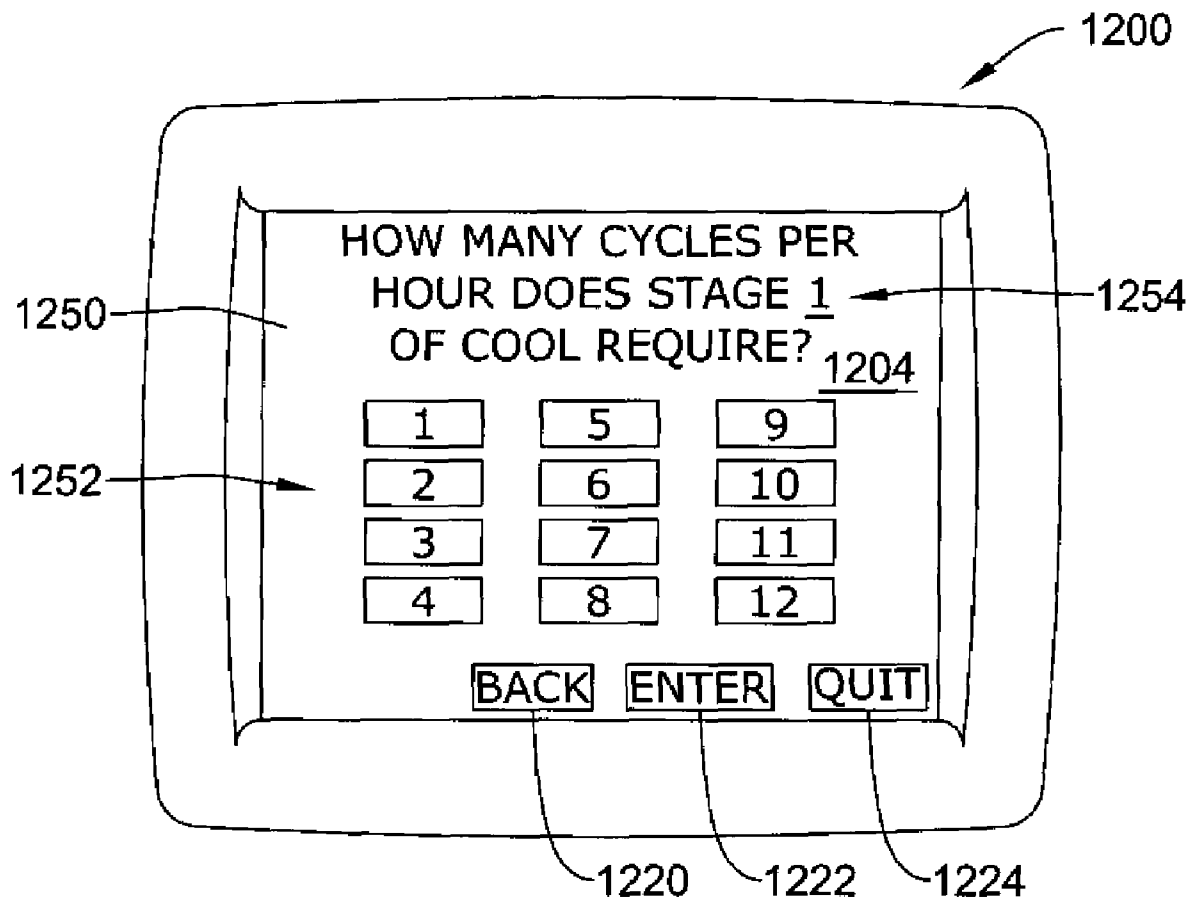

Figure 13H

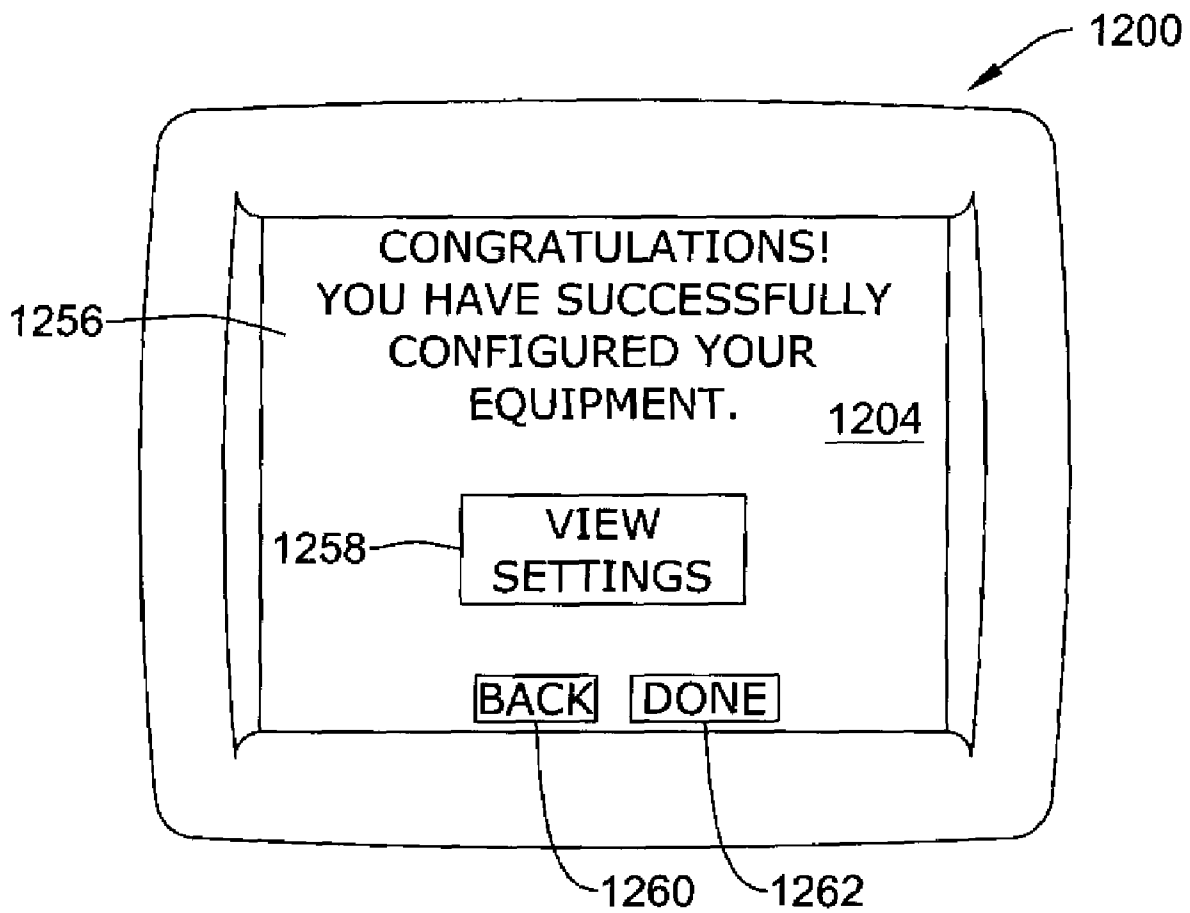

Figure 13I

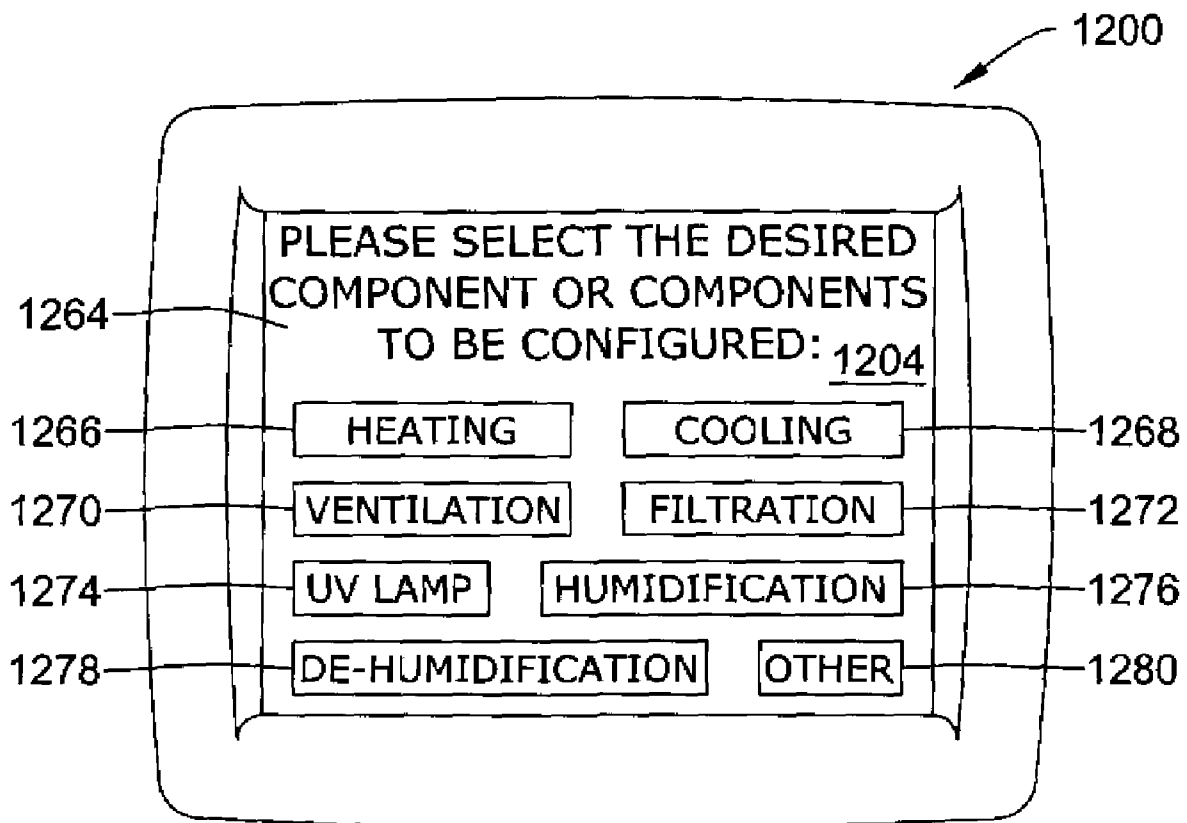

Figure 13J

NATURAL LANGUAGE INSTALLER SETUP FOR CONTROLLER

CROSS REFERENCE TO RELATED APPLICATION

The present invention is a continuation-in-part of U.S. patent application Ser. No. 10/726,245, entitled "Controller Interface With Interview Programming", filed on Dec. 2, 2003.

FIELD

The present invention relates generally to the field of programmable controllers for homes and/or buildings and their related grounds. More specifically, the present invention relates to simplified interfaces for such controllers having interview programming capabilities.

BACKGROUND

Controllers are used on a wide variety of devices and systems for controlling various functions in homes and/or buildings and their related grounds. Some controllers have schedule programming that modifies device parameter set points as a function of date and/or time. Some such device or system controllers that utilize schedule programming for controlling various functions in homes and/or buildings and their related grounds include, for example, HVAC controllers, water heater controllers, water softener controllers, security system controllers, lawn sprinkler controllers, and lighting system controllers.

HVAC controllers, for example, are employed to monitor and, if necessary, control various environmental conditions within a home, office, or other enclosed space. Such devices are useful, for example, in regulating any number of environmental conditions with a particular space including for example, temperature, humidity, venting, air quality, etc. The controller may include a microprocessor that interacts with other components in the system. For example, in many modern thermostats for use in the home, a controller unit equipped with temperature and humidity sensing capabilities may be provided to interact with a heater, blower, flue vent, air compressor, humidifier and/or other components, to control the temperature and humidity levels at various locations within the home. A sensor located within the controller unit and/or one or more remote sensors may be employed to sense when the temperature or humidity reaches a certain threshold level, causing the controller unit to send a signal to activate or deactivate one or more components in the system.

The controller may be equipped with an interface that allows the user to monitor and adjust the environmental conditions at one or more locations within the building. With more modern designs, the interface typically includes a liquid crystal display (LCD) panel inset within a housing that contains the microprocessor as well as other components of the controller. In some designs, the interface may permit the user to program the controller to activate on a certain schedule determined by the user. For example, the interface may include a separate menu routine that permits the user to change the temperature at one or more times during a particular day. Once the settings for that day have been programmed, the user can then repeat the process to change the settings for the other remaining days.

With more modern designs, the programmable controller may include a feature that allows the user to set a separate schedule for weekday and weekend use, or to copy the set-

tings for a particular day and then apply them towards other selected days of the week. While these designs allow the user to copy settings from one day to another, a number of steps are often required to establish a program, adding to the complexity of the interface. In some cases, the interface may not permit the user to select multiple days outside of the normal weekday/weekend scheme. In other cases, the interface is simply too complex to be conveniently used to program a temperature scheme and is simply by-passed or not programmed by the user. Accordingly, there is an ongoing need in the art to decrease the time and complexity associated with programming a multi-day schedule in a programmable controller.

During the installation process, the steps required to program the controller to operate with other system components can also add to the time and complexity associated with configuring the controller. Typically, programming of the controller is accomplished by entering in numeric codes via a fixed segment user interface, by manually setting jumper switches on a circuit board, or by adjusting screws or potentiometers on a circuit board. In some cases, the codes or settings used to program the controller are obtained from a manual or table which must be consulted by the installer during the installation process. For example, to configure an HVAC system having a multistage heat pump, the controller may require the installer to enter a numeric or alphanumeric code (e.g. 91199) from a manual or table in order to program the controller to properly operate the various stages of the heat pump. Such process of referring to a manual or table of codes is not often intuitive to the user, and requires the user to store the manual in a safe place for subsequent use. Accordingly, there is also an ongoing need in the art to decrease the time and complexity associated with programming the controller during the installation process.

SUMMARY

Generally, the present invention pertains to simplified interfaces for controllers having interview programming capabilities.

In one illustrative embodiment, a method of programming a schedule of a controller having a user interface is described. The illustrative method includes the steps of providing one or more interview questions to a user via the user interface; accepting one or more user responses to the one or more interview questions from the user via the user interface; and creating and/or modifying or building a schedule based on the user responses.

In another illustrative embodiment, a method of programming configuration information within a controller is further described. An illustrative method can include the steps of providing one or more interview questions to a user via a user interface, prompting the user to selected between at least two answers simultaneously displayed on the user interface, accepting one or more user responses to the interview questions via the user interface, and modifying the operational parameters of the controller and/or one or more components controlled by the controlled based at least in part on the user responses. The interview questions can include at least one question relating to the installation or setup of the controller as well as any components controlled by the controller.

An illustrative controller having interview programming capabilities can include an interview question generator adapted to generate a number of interview questions relating to the installation or setup of the controller and/or any components controlled by the controller, a user interface including a display screen adapted to display interview questions to

a user along with at least two answers for each interview question, and a memory unit for storing operational parameters within the controller based at least in part on the user responses to the interview questions.

The above summary of the present invention is not intended to describe each disclosed embodiment or every implementation of the present invention. The Figures, Detailed Description and Examples which follow more particularly exemplify these embodiments.

BRIEF DESCRIPTION OF THE DRAWINGS

The invention may be more completely understood in consideration of the following detailed description of various embodiments of the invention in connection with the accompanying drawings, in which:

FIG. 1 is a flow diagram of an illustrative HVAC interview program;

FIG. 2 is a block diagram of the illustrative HVAC interview program shown in FIG. 1;

FIG. 3 is a flow diagram of another illustrative HVAC interview program;

FIG. 4A is a block diagram of the illustrative HVAC interview program shown in FIG. 3;

FIG. 4B is an illustrative partial block diagram of the block diagram shown in FIG. 4A;

FIG. 5 is a flow diagram of another illustrative HVAC interview program;

FIG. 6 is a block diagram of the illustrative HVAC interview program shown in FIG. 5;

FIGS. 7A-C are flow diagrams of another illustrative HVAC interview program;

FIGS. 8A-T are schematic drawings of an illustrative HVAC interface showing an embodiment of the flow diagram of the illustrative HVAC interview program shown in FIG. 7;

FIG. 9 is a block diagram of an illustrative HVAC system including a programmable controller having interview capabilities for configuring one or more HVAC components;

FIG. 10 is a block diagram showing the controller and user interface of FIG. 9;

FIG. 11 is a flow diagram showing several illustrative interview questions and answers that can be provided by the interview question generator of FIG. 10;

FIG. 12 is a flow diagram of an illustrative method of programming configuration information within a controller; and

FIGS. 13A-13J are schematic drawings of an illustrative user interface showing an illustrative implementation of the flow diagram depicted in FIG. 12.

While the invention is amenable to various modifications and alternative forms, specifics thereof have been shown by way of example in the drawings and will be described in detail. It should be understood, however, that the intention is not to limit the invention to the particular embodiments described. On the contrary, the intention is to cover all modifications, equivalents, and alternatives falling within the spirit and scope of the invention.

DETAILED DESCRIPTION

The following description should be read with reference to the drawings, in which like elements in different drawings are numbered in like fashion. The drawings, which are not necessarily to scale, depict selected embodiments and are not intended to limit the scope of the invention. Although examples of construction, dimensions, and materials are illustrated for the various elements, those skilled in the art will

recognize that many of the examples provided have suitable alternatives that may be utilized.

Generally, the present invention pertains to simplified interfaces for controllers having interview programming capabilities. These controllers can be used in a variety of systems such as, for example, HVAC systems, water heater systems, water softener systems, sprinkler systems, security systems, lighting systems, and the like. The Figures depict HVAC controllers. While the present invention is not so limited, an appreciation of various aspects of the invention will be gained through a discussion of the examples provided below.

FIG. 1 is a flow diagram of an illustrative HVAC interview program **100**. The flow diagram starts at a normal thermostat operation block **110**. Normal thermostat operation block **110** can be an initial parameter setting operation or a modification of parameter settings. Interview scheduling block **120**, **130** provides one or more interview questions to a user via the user interface. The user interface can accept one or more responses to the one or more interview questions from the user via the user interface. The schedule is then built or modified, in some cases by adding or modifying one or more schedule parameters **140**, **150**, based on the user responses provided via the user interface. Once the schedule parameters **140**, **150** are modified, the controller can return to the normal operation block **110**, and follow the new schedule.

In some embodiments, the interview scheduling blocks **120** and **130** can provide interview questions that elicit an affirmative (e.g., "yes") or negative (e.g., "no") user response. Alternatively, or in addition, the interview scheduling blocks **120**, and **130** can provide include interview questions that allow a user to select one (or more) answers from a predetermined list of answers.

In some embodiments, these interview questions can solicit information from the user regarding the grouping of the controller set points entered or the temporal relationship of the controller set points such as, for example, the interview question may ask "Do you want the schedule to apply to every day of the week?", requiring the user to respond with a "YES" or "NO" answer. The interview scheduling block **120** preferably includes questions that are natural language questions, which may be phrases that have one, two, three, four, five, six, or seven or more words, although this is not required in all embodiments.

Alternatively, or in addition, interview scheduling block **130** can provide interview questions that require a numerical user response. For example, these interview questions can solicit information from the user regarding the specific time and temperature set points for each grouping of controller set points solicited by the interview block **120** described above. Interview block **130** can provide a question such as, for example, "What is a comfortable sleeping temperature in the winter?", requiring the user to respond with a numerical temperature answer. Like interview schedule block **120** above, interview scheduling block **130** can include questions that are natural language questions, which may be phrases that have one, two, three, four, five, six, or seven or more words, although this is not required in all embodiments.

The interview scheduling blocks **120** and **130** can provide one or more interview questions about, for example, which weekdays will have the same schedule?, when a first person wakes up?, when a last person goes to sleep?, when a last person leaves during the day?, when a first person arrives home?, what a comfortable temperature is when heat is on?, what a comfortable temperature is when air conditioning is on?, what a comfortable sleeping temperature is in summer?, and/or what a comfortable sleeping temperature is in winter?

Alternatively, or in addition, the interview scheduling blocks 120 and 130 may provide one or more interview questions that provide a plurality of predetermined answers or responses (e.g., multiple choice format) where the user selects an answer or response. For example, the interview question may provide a question such as, "What type of schedule do you desire?" In this illustrative embodiment, a series of predetermined responses or answers can be provided such as, "Every day of the week is the same," "Weekdays are the same and Saturday/Sunday is the same," "Weekday are the same and Saturday/Sunday is different," "Each Weekday is different and Saturday/Sunday is the same," and "Each day of the week is different."

Alternatively, or in addition, once an initial schedule has been built, the interview scheduling blocks 120, and 130 can display a previous answer that was accepted by the user interface based on the prior built schedule. This illustrative feature can provide the user with a convenient option to select and alter only the schedule parameters 140, 150 that the user desires to modify. This feature can be utilized in all illustrative embodiments described herein, however it is not required.

FIG. 2 is a block diagram of the illustrative HVAC controller with an illustrative interview function similar to that shown in FIG. 1. Controller 200 includes a control module 210 that can be a microprocessor or the like. The control module 210 communicates with a user interface 220, and can include an interview question generator 225, a response acceptor 240 and a programmable schedule 250. The control module 210 can also generate a control signal 260 to a device (not shown), such as an HVAC system or device.

In an illustrative embodiment, the interview question generator 225 provides interview questions, such as those described above, to the user interface 220. The user interface 220 can be any form of user interface such as, for example, a physical interface including a touchscreen, an LCD with buttons, and/or an aural interface including a speaker and microphone, or any other suitable user interface. A user can activate the interview question generator 225 by any suitable mechanism, such as by pressing a schedule button on a touchscreen of the user interface 220. Alternatively, or in addition, the controller 210 may activate the interview question generator 225 on its own, such as when it believes additional scheduling information is needed or might otherwise be desired. In response to questions posed by the interview question generator 225, the user can enter one or more user responses into the user interface 220. The response acceptor 240 accepts the user responses and provides the response to the programmable schedule 250. In some embodiments, the programmable schedule 250 has a number of time and temperature set points that can be entered or modified by the response acceptor 240. Once the schedule is built and/or modified, a control signal 260 is generated by the control module 210 based on the programmable schedule 250.

FIG. 3 is a flow diagram of another illustrative HVAC interview program 300. The flow diagram starts at a normal thermostat operation block 310. Normal thermostat operation block 310 can be an initial parameter setting operation or a modification of parameter settings. Interview scheduling block 325 provides one or more interview questions to a user via a user interface. The user interface then accepts one or more responses to the one or more interview questions from the user via the user interface. A user response translator 360 translates the one or more user responses to form a translated response. One or more schedule parameters 370 are then modified based on the translated responses from the response

translator 360. Once the schedule parameters 370 are modified, the controller can return to the normal operation block 310.

In some embodiments, the interview scheduling block 325 includes interview questions that require an affirmative (e.g., "yes") or negative (e.g., "no") user response. In addition, the interview questions can solicit information from the user regarding the grouping of the controller set points entered or the temporal relationship of the controller set points. For example, the interview question may ask "Do you want the schedule to apply to every day of the week?", requiring the user to respond with a "YES" or "NO" answer. The interview scheduling block 325 can include questions that are natural language questions such as, for example, phrases that can have one, two, three, four, five, six, or seven or more words.

In an illustrative embodiment, interview scheduling block 325 may also provide interview questions that require a numerical user response. These interview questions can solicit information from the user regarding the specific time and temperature set points for each grouping of controller set points solicited by the interview block 325 described above. The interview block 325 can provide a question such as, for example, "What is a comfortable sleeping temperature in the winter?", requiring the user to respond with a numerical temperature answer. The interview scheduling block 325 can include questions that are natural language questions such as, for example, phrases that can have one, two, three, four, five, six, or seven or more words.

In the illustrative embodiment, the interview scheduling block 325 can also provide one or more interview questions related to, for example, which weekdays will have the same schedule?, when a first person wakes up?, when a last person goes to sleep?, when a last person leaves during the day?, when a first person arrives home?, what a comfortable temperature is when heat is on?, what a comfortable temperature is when air conditioning is on?, what a comfortable sleeping temperature is in the summer?, or what a comfortable sleeping temperature is in the winter?

The response translator 360 can translate the user responses to create appropriate schedule parameters 370 that help define the schedule of the controller. That is, the response translator 360 applies the user responses to one or more interview questions to establish the controller schedule. For example, the response translator 360 can take an affirmative user response to the interview question, "Do you want the same schedule for Saturday and Sunday?" and correlate with the interview question, "What temperature do you like when the heat is on?" to establish the schedule parameters for the heating temperature during at least selected periods on Saturday and Sunday.

Alternatively, or in addition, the interview scheduling block 325 may provide one or more interview questions that provide a plurality of predetermined answers or responses (e.g., multiple choice format) where the user selects an answer or response. For example, the interview question may provide a question such as, "What type of schedule do you desire?" In this illustrative embodiment, a series of predetermined responses or answers can be provided such as, "Every day of the week is the same," "Weekdays are the same and Saturday/Sunday is the same," "Weekday are the same and Saturday/Sunday is different," "Each Weekday is different and Saturday/Sunday is the same," and "Each day of the week is different."

FIG. 4A is a block diagram of the illustrative HVAC controller with an illustrative interview function similar to that shown in FIG. 3. Controller 400 includes a control module 410 that can be a microprocessor or the like. The control

module **410** communicates with a user interface **420**, and may include an interview question generator **425**, a response acceptor **440**, a response translator **460**, and a programmable schedule **470**. The control module **410** can also generate a control signal **465** to a device (not shown), such as an HVAC system or device.

In the illustrative embodiment, the interview question generator **435** provides interview questions, such as those described above, to the user interface **420**. The user interface **420** can be any form of user interface such as, for example, a physical interface including a touchscreen, an LCD with buttons, and/or an aural interface including a speaker and microphone, or any other suitable user interface. A user can activate the interview question generator **435** by any suitable mechanism, such as by pressing a mechanical schedule button on the controller, touching an appropriate region of a touchscreen, voice activation, etc. Alternatively, or in addition, the controller **410** may activate the interview question generator **425** on its own, such as when it believes additional scheduling information is needed or might otherwise be desired. In response to questions posed by the interview question generator **425**, the user can enter one or more user responses into the user interface **420**. The response acceptor **440** accepts the user responses and provides the response to the response translator **460**. The response translator **460** provides a translated response to a programmable schedule **470**. In some embodiments, the programmable schedule **470** has a number of time and temperature set points that can be entered or modified by the response translator **470**. Once the schedule is built and/or modified a control signal **465** is generated by the control module **410** based on the programmable schedule **470**.

FIG. 4B is an illustrative partial block diagram of the block diagram shown in FIG. 4A showing one embodiment of the interaction of the interview question generator **425**, response acceptor **440**, response translator **460** and programmable schedule **470**. The illustrative programmable schedule **470** has a plurality of cells such as, for example, a Saturday wake cell **471**, a Sunday wake cell **472**, a Saturday sleep cell **473**, and a Sunday sleep cell **474**. In this embodiment, each cell **471**, **472**, **473**, **474** may include a number of schedule parameters such as, for example, a start time, a heat temperature and a cool temperature.

Interview questions **425** are posed to the user. As shown in the illustrative example: an interview question **425** of "Same schedule for Saturday and Sunday?" elicits an user response **440** of "YES"; an interview question **425** of "For the weekend, is someone home all day?" elicits an user response **440** of "YES"; an interview question **425** of "What time does the first person wake up?" elicits an user response **440** of "7:00 a.m."; an interview question **425** of "what time does the last person go to sleep?" elicits an user response **440** of "10:00 p.m."; an interview question **425** of "What temperature is comfortable when the heat is on?" elicits an user response **440** of "72° F."; an interview question **425** of "What temperature is comfortable when the air conditioning is on?" elicits an user response **440** of "68° F."; an interview question **425** of "What is a comfortable sleeping temperature in summer?" elicits an user response **440** of "67° F."; and an interview question **425** of "What is a comfortable sleeping temperature in winter?" elicits an user response **440** of "65° F."

In the illustrative embodiment, the response translator **460** accepts the user responses provided in block **440**. The response translator **460** then builds and/or modifies the programmable schedule **470**. In the illustrative embodiment, each cell **471**, **472**, **473**, **474** includes a start time, a heat temperature and a cool temperature. The Saturday wake cell **471** and the Sunday wake cell **472** has a start time of 7:00

a.m., a heat temperature of 72° F., and a cool temperature of 68° F., all of the times and temperatures are provided by the response translator. The Saturday sleep cell **473** and the Sunday sleep cell **474** has a start time of 10:00 p.m., a heat temperature of 65° F., and a cool temperature of 67° F., all of the times and temperatures are provided by the response translator.

In this illustrative embodiment, the response translator **460** takes a plurality of user responses **440** to the interview questions **425** and builds and/or modifies a plurality of schedule parameters. The Saturday and Sunday Leave and Return cells **475**, **476**, **477**, and **478** are ignored and/or zeroed out by the response translator **460** since they are not required based on the user responses **425** for this example.

FIG. 5 is a flow diagram of another illustrative HVAC interview program **500**. The flow diagram starts at a normal thermostat operation block **510**. Normal thermostat operation block **510** can be an initial parameter setting operation or a modification of parameter settings. Interview scheduling block **525** provides one or more interview questions to a user via a user interface. The user interface then accepts one or more responses to the one or more interview questions from the user via the user interface. A sufficient information block **560** determines if enough information has been solicited from the user response to the interview questions sufficient to build or modify the schedule at block **570**. If not, the interview scheduling block **525** provides another interview question to the user via the user interface. If the sufficient information block **560** determines that enough information has been solicited, then the schedule is built or modified by the modify schedule block **570**. Once the schedule is built or modified by the modify schedule block **570**, the controller can return to the normal operation block **510**.

The sufficient information block **560** can, for example, help ensure that a sufficient number of schedule parameters are defined, such as, for example, a start time, a heating temperature and a cooling temperature for a particular time period such as, for example, a specific day or group of days wake period, leave period, return period and/or sleep period, as shown in FIG. 4B.

In some embodiments, the interview scheduling block **525** provides a number of predetermined interview questions in a predetermined sequential order. The number of questions or queries may be adapted to collect information from the user responses to generate at least a portion of the schedule parameters.

Like above, the interview scheduling block **525** can include interview questions that require an affirmative (e.g., "yes") or negative (e.g., "no") user response. For example, interview scheduling block **525** can provide interview questions solicit information from the user regarding the grouping of the controller set points entered or the temporal relationship of the controller set points such as, for example, "Do you want the schedule to apply to every day of the week?", requiring the user to respond with a "YES" or "NO" answer. The interview scheduling block **525** can include questions that are natural language questions which can be phrases that have one, two, three, four, five, six, or seven or more words in length.

Alternatively or in addition, interview scheduling block **525** can provide interview questions that require a numerical user response. For example, these interview questions can solicit information from the user regarding the specific time and temperature set points for each grouping of controller set points solicited by the interview block **525** described above. The interview block **525** can provide a question such as, for example, "What is a comfortable sleeping temperature in the winter?", requiring the user to respond with a numerical

temperature answer. Again, the interview scheduling block 525 can include questions that are natural language questions that can be phrases which can be one, two, three, four, five, six, seven or more words, although this is not required in all embodiments.

The interview scheduling block 525 may also provide one or more interview questions about, which weekdays will have a same schedule?, when a first person wakes up?, when a last person goes to sleep?, when a last person leaves during the day?, when a first person arrives home?, what a comfortable temperature is when heat is on?, what a comfortable temperature is when air conditioning is on?, what a comfortable sleeping temperature is in the summer?, or what a comfortable sleeping temperature is in the winter?

Alternatively, or in addition, the interview scheduling block 525 may provide one or more interview questions that provide a plurality of predetermined answers or responses (e.g., multiple choice format) where the user selects an answer or response. For example, the interview question may provide a question such as, "What type of schedule do you desire?" In this illustrative embodiment, a series of predetermined responses or answers can be provided such as, "Every day of the week is the same," "Weekdays are the same and Saturday/Sunday is the same," "Weekday are the same and Saturday/Sunday is different," "Each Weekday is different and Saturday/Sunday is the same," and "Each day of the week is different."

FIG. 6 is a block diagram of the illustrative HVAC controller with an illustrative interview function similar to that shown in FIG. 5. Controller 600 includes a control module 610 that can be a microprocessor or the like. The control module 610 communicates with a user interface 620, and may include an interview question generator 625, a response acceptor 640 and a programmable schedule 650. The control module 610 can also generate a control signal 660 to a device (not shown), such as an HVAC system or device.

In the illustrative embodiment, the interview question generator 625 provides interview questions, such as those described above, to the user interface 620. The user interface 620 can be any form of user interface such as, for example, a physical interface including a touchscreen, an LCD with buttons, an aural interface including a speaker and microphone, or any other suitable user interface. A user can activate the interview question generator 625 by any suitable mechanism, such as by pressing a schedule button on a touchscreen of the user interface 620. Alternatively, or in addition, the controller 610 may activate the interview question generator 625 on its own, such as when it believes additional scheduling information is needed or might otherwise be desired. In response to the questions posed by the interview question generator 625, the user can enter one or more user responses into the user interface 620. The response acceptor 640 accepts the user responses and provides the responses to the programmable schedule 650 if it determines that sufficient information has been provided by the user responses to establish a program schedule. If not, the response acceptor 640 instructs the interview question generator 625 to provide another interview question to the user via the user interface 620. Once the response acceptor 640 determines that sufficient information has been provided by the user to establish a program schedule 650 the program schedule 650 is built and/or modified. In some embodiments, the programmable schedule 650 has a number of time and temperature set points that can be entered or modified by the response acceptor 640. Once the programmable schedule 650 is built and/or modified, a control signal 660 is generated by the control module 610 based on the programmable schedule 650.

FIGS. 7A-C are flow diagrams of another illustrative HVAC interview program 700. The flow diagram starts at a normal thermostat operation block 710, but this is not required in all embodiments. In the illustrative embodiment, the interview program 700 can be initiated by pressing a program initiation button or key such as, for example, an "EZ Schedule" button.

The program can begin by asking whether the user wants the same schedule to be used for every day of the week, as shown at block 720. If the user responds with a "YES" response, then the program can move to ask context questions for that group of days, as shown at block 725, which may set the schedule for the week assuming the same schedule for every 24 hour period or day. If the user responds with a "NO" response, the program may ask the user if the same schedule applies to both weekend days, Saturday and Sunday, as shown at block 730. If the user responds with a "YES" response, then the program can ask if the user wants two schedules, one for weekdays and one for weekends, as shown at block 735. A "YES" response to block 735 can move the program to asking context questions for a weekend group of days and a weekdays group of days, as shown at block 725, to set the schedule for the week assuming a first schedule for weekend days and a second schedule for weekdays. A "NO" response to block 730 can cause the program to ask whether the user wants three schedules including a weekday schedule, a Saturday schedule, and a Sunday schedule, as shown at block 740. A "YES" response to block 740 moves the program to asking context questions for a week day group of days schedule, a Saturday schedule and a Sunday schedule, as shown at block 725, to set the schedule for the week assuming a first schedule for weekdays, and a second schedule for Saturday and a third schedule for Sundays. A "NO" response to either block 740 or block 735 moves the program to asking the user to group each day of the seven days of the week into similar schedule groupings until all days are assigned to one group, as shown at block 750. The program can ask if all days are assigned at block 755, with a "NO" response returning the user to block 750 to assign a non-assigned day or days until all days have been assigned. Once all days have been assigned to a group, the program moves to asking context questions for each group of days schedule, as shown at block 725, to set the schedule for the each grouping of days assuming a first schedule for a first group, a second schedule for a second group, a third schedule for a third group and so on until all groupings of days are scheduled.

The program 700 can ask a variety of context sensitive question to determine the desired schedule for each grouping of days identified by the program 700 above. For example, and as shown in FIG. 7B, the program 700 can inquire whether someone is home all day, as shown at block 760. If the user enters a "YES" response to block 760, the program can ask when the first person gets and request that the user to enter a wake time, as shown at block 770. Then the program 700 can ask when the last person goes to sleep and request that the user to enter a sleep time, as shown at block 780. If the user enters a "NO" response to block 760, the program can ask when the first person gets up, and request that the user to enter a wake time, as shown at block 761. Then the program can ask what time the first person leaves home and request that the user enter a leave time, as shown at block 762. The program can also ask when the last person gets home for the day, and request the user to enter a return time, as shown at block 763. The program can also ask when the last person goes to sleep, and request that the user enter a sleep time, as shown at block

764. Once all the above information has been entered by the user for each grouping of days, the program may move to an end block 781.

The program 700 can then request information from the user regarding comfortable awake, sleeping and away temperatures. For example, and referring to FIG. 7C, the program can request that the user enter a comfortable temperature when the heat is on, as shown at block 790. The temperature information received in block 790 can be automatically inserted into a program schedule for each grouping of days to set the wake heat and return heat set points. The program can also request that the user enter a comfortable temperature when the air conditioning is on, as shown at block 791. This information can be automatically inserted into a program schedule for each grouping of days to set the wake cool and return cool set points. This illustrative program can also request that the user enter a comfortable summer sleeping temperature, as shown at block 792. This information can be automatically inserted into a program schedule for each grouping of days to set the sleep cool set point. The program can also request that the user enter a comfortable winter sleeping temperature, as shown at block 793. This information can be automatically inserted into a program schedule for each grouping of days to set the sleep heat set point. The program can also request that the user to enter an energy savings offset at block 794. This information can be automatically inserted into a program schedule for each grouping of days to set the leave cool and leave heat set points.

In some embodiments, the program 700 can allow the user to request a schedule review at block 795, which can allow the user to review the built or modified schedule, as shown at block 796. If the user does not wish to review the schedule or when the user is done reviewing the schedule, the program returns to normal thermostat operation block 710 under the newly built or modified schedule.

FIGS. 8A-T are schematic drawings of an illustrative HVAC interface 800 showing an illustrative embodiment of the flow diagram of the HVAC interview program shown in FIGS. 7A-7C. The schematic screen shots are taken in sequential order based on the user selections shown in each screen shot. At FIG. 8A, a user 810 selects an "EZ Schedule" 801 button located on the interface 800 to begin the interview scheduling program.

At FIG. 8B, the program asks the user 810, via the interface 800, if the user 810 wants the same schedule to apply to every day of the week. The user 810 is shown selecting a "NO" response 802.

At FIG. 8C, the program asks the user 810, via the interface 800, if the user 810 wants Saturday and Sunday to follow the same schedule. The user 810 is shown selecting a "YES" response 803.

At FIG. 8D, the program asks the user 810, via the interface 800, to verify that there will be two schedules, one for weekends and a second for weekdays. The user 810 is shown selecting a "YES" response 804.

At FIG. 8E, the program asks the user 810, via the interface 800, whether someone will be home all day on weekdays. The user 810 is shown selecting a "NO" response 805.

At FIG. 8F, the program asks the user 810, via the interface 800, to enter what time the first person wakes up on weekdays. The user 810 is shown pressing an "ENTER" button 806 after selecting a wake time.

At FIG. 8G, the program asks the user 810, via the interface 800, to enter what time the last person leaves the house on weekdays. The user 810 is shown pressing an "ENTER" button 807 after selecting a leave time.

At FIG. 8H, the program asks the user 810, via the interface 800, to enter what time the first person arrives home on weekdays. The user 810 is shown pressing an "ENTER" button 808 after selecting a return time.

At FIG. 8I, the program asks the user 810, via the interface 800, to enter what time the last person goes to sleep on weekdays. The user 810 is shown pressing an "ENTER" button 809 after selecting a sleep time.

At FIG. 8J, the program asks the user 810, via the interface 800, whether someone will be home all day on weekends. The user 810 is shown selecting a "YES" response 811.

At FIG. 8K, the program asks the user 810, via the interface 800, to enter what time the first person wakes up on weekends. The user 810 is shown pressing an "ENTER" button 812 after selecting a wake time.

At FIG. 8L, the program asks the user 810, via the interface 800, to enter what time the last person goes to sleep on weekends. The user 810 is shown pressing an "ENTER" button 813 after selecting a sleep time.

At FIG. 8M, the program asks the user 810, via the interface 800, a comfort question such as, what temperature do you like when the heat is on? The user 810 is shown pressing an "ENTER" button 814 after selecting a desired temperature.

At FIG. 8N, the program asks the user 810, via the interface 800, a comfort question such as, what temperature do you like when the air conditioning is on? The user 810 is shown pressing an "ENTER" button 815 after selecting a desired temperature.

At FIG. 8O, the program asks the user 810, via the interface 800, a comfort question such as, what is a comfortable sleeping temperature in the summer? The user 810 is shown pressing an "ENTER" button 816 after selecting a desired temperature.

At FIG. 8P, the program asks the user 810, via the interface 800, another comfort question such as, what is a comfortable sleeping temperature in the winter? The user 810 is shown pressing an "ENTER" button 817 after selecting a desired temperature.

At FIG. 8Q, the program asks the user 810, via the interface 800, another comfort question such as, what energy saving offset is desired? The user 810 is shown pressing an "ENTER" button 818 after selecting a desired energy saving offset.

At FIG. 8R, the program informs the user 810, via the interface 800, that the schedule has been completed, and may allow the user to view a portion of the schedule or selected day groupings. The user 810 is shown pressing a "VIEW WEEKDAYS" button 819.

At FIG. 8S, the program informs the user 810, via the interface 800, specifics of the selected schedule. The user 810 is shown pressing a "DONE" button 821.

At FIG. 8T, the program displays, via the interface 800, specifics of the currently running schedule.

Referring now to FIG. 9, a block diagram of an illustrative HVAC system including a programmable controller having interview capabilities for configuring one or more HVAC components will now be described. The HVAC system 900 can include a programmable controller 902 in communication with a number of system components that can be activated to regulate various environmental conditions such as temperature, humidity, and air quality levels occurring within the space to be controlled. As shown in FIG. 9, for example, the controller 902 can be connected to a heating unit 904 and cooling unit 906 that can be activated to regulate temperature. The heating unit 904 can include a boiler, furnace, heat pump, electric heater, and/or other suitable heating device. In some

embodiments, the heating unit **904** can include a multistage device such as a multistage heat pump, the various stages of which can be controlled by the controller **902**. The cooling unit **906** can include an air-conditioner, heat pump, chiller, and/or other suitable cooling device which can likewise be

either single staged or multistaged depending on the application. A ventilation unit **908** such as a fan or blower equipped with one or more dampers can be employed to regulate the volume of air delivered to various locations within the controlled space. A filtration unit **910**, UV lamp unit **912**, humidifier unit **914**, and dehumidifier unit **916** can also be provided in some embodiments to regulate the air quality and moisture levels within the controlled space. One or more local and/or remote sensors **918** can be connected to the controller **902** to monitor temperature or humidity levels inside, and in some cases, outside of the space to be controlled. In some embodiments, the controller **902** can be connected to one or more other controllers **920** such as another HVAC controller for providing multi-zoned climate control. The system components can be directly connected to a corresponding I/O port or I/O pins on the controller **902**, and/or can be connected to the controller **902** via a network or the like.

The controller **902** can include a user interface **922** to permit an installer or service technician to input commands for programming the controller **902** to operate with the various system components and any other connected controllers **922**. The user interface **922** can include, for example, a touch screen, liquid crystal display (LCD) or dot matrix display, an aural interface including a speaker and microphone, a computer, or any other suitable device for sending and receiving signals to and from the controller **902**. Depending on the configuration, the user interface **922** can also include buttons, knobs, slides, a keypad, or other suitable selector means for inputting commands into the controller **902**.

FIG. **10** is a block diagram showing the controller **902** and user interface **922** of FIG. **9** in greater detail. As can be further seen in FIG. **10**, the controller **902** can include a control module **924** such as a microprocessor/CPU, a storage memory **926**, a clock **928**, and an I/O interface **930** that connects the controller **902** to the various system components in FIG. **9**. An internal sensor **932** located within the controller housing can be used to measure the temperature, humidity levels, and/or other environmental conditions occurring within the controlled space.

During installation, the control module **924** communicates with the user interface **922** to provide the installer with interview questions relating to the configuration of one or more of the system components. In the illustrative embodiment of FIG. **10**, the controller **902** includes an interview question generator **934** that prompts the installer to provide feedback to the controller **902** regarding the types of system components to be controlled, the dates and times such components are to be operated, the power or temperature levels in which such components are to be operated, the bandwidth or offsets at which such components are to be operated, the type of space to be controlled, as well as other operating parameters. Activation of the interview question generator **934** can occur, for example, by pressing an installation button on a touchscreen or keypad of the user interface **922**. Alternatively, or in addition, the controller **902** may activate the interview question generator **934** on its own when a new system component is connected to the I/O interface **930** or when additional setup information is needed or desired by the controller **902**.

Input commands received via the user interface **922** can be fed to a response acceptor **936**, which accepts the user responses to the interview questions generated by the inter-

view question generator **934**. The response acceptor **936** can be configured to translate the user responses into operation parameters **938** that can be stored within the memory unit **926** along with other information such as prior usage, scheduling parameters, user preferences, etc. The operation parameters **938** can then be used by the controller **902** to generate control signals **940** to operate the various system components in a particular manner.

FIG. **11** is a flow chart showing several illustrative interview questions and answers that can be provided by the interview question generator of FIG. **10**. As shown in FIG. **11**, once the installation mode has been initiated, the user interface can be configured to prompt the installer to enter a desired language in which to display the interview question and answer queries, as indicated generally by block **1000**. For example, the user interface may prompt the installer to select between “English”, “Español”, or “Français” as language choices. The selection of a particular language at block **1000** causes the user interface to subsequently display the interview questions and answers in that selected language.

Once the desired language is chosen, the user interface can be configured to provide interview questions pertaining to the various system components to be installed. At block **1002**, for example, the user interface can prompt the installer to select the type of equipment to be controlled by the controller. In certain embodiments, for example, the user interface can prompt the installer to select between a conventional heating/cooling unit, a heat pump, or heat only. Once the type of equipment has been selected, the user interface may then prompt the installer to enter the number of stages of heat and cool to be controlled by the controller, as indicated generally by blocks **1004** and **1006**. In some embodiments, the answers provided to the interview question at block **1004** may affect whether the user interface displays a follow-up query at block **1006**. For example, if the response to the interview question regarding the number of heat stages at block **1004** is “2”, the interview question generator may assume that there are 2 cooling stages, and thus skip the query at block **1006**.

For each stage of heat and cool, the user interface can be configured to prompt the installer to select the number of cycles per hour to be provided by the equipment, as indicated generally by block **1008** and **1010**, respectively. At block **1008**, for example, the user interface may prompt the installer to select the cycles per hour to be provided by each stage of heating selected at block **1004**. If, for example, the installer indicates at block **1004** that the equipment has 3 stages of heating, the user interface can be configured to repeat query block **1008** three separate times for each individual stage to be configured. A similar process can then be performed at block **1010** for each stage of cooling to be controlled by the controller. If at block **1004** the installer indicates that there are “0” stages of heat, the user interface can be configured to skip the query at block **1008**. In addition, if at block **1006** the installer indicates that there are “0” stages of cool, or if at block **1002** the installer indicates that the equipment is “Heat Only”, the user interface can be configured to skip the query at block **1010**.

In some embodiments, the user interface can be further configured to provide the installer with interview questions and answers that can be used to set other operational parameters within the controller. As indicated generally at block **1012**, for example, the user interface can be configured to prompt the installer to select the minimum amount of on time that the equipment operates. The user interface can further prompt the installer to select a lower and/or upper temperature limit at which the system operates, as indicated generally at blocks **1014** and **1016**, respectively. If desired, the tempera-

15

ture offset and proportional bandwidth of the system can be further set via query blocks 1018 and 1020, respectively.

Although several exemplary interview questions and answers are illustrated in FIG. 11, it should be understood that the type, number, and ordering of the interview questions and answers provided to the installer may be varied based on the type of equipment to be configured, the user's previous answers to interview questions, the number of stages to be controlled, as well as other factors. In some embodiments, the interview questions and answers can be grouped together to permit the installer to configure a particular system component or components without having to answer interview questions for the remaining system components. If, for example, the installer desires to only configure a newly installed heat pump, the user interface can be configured to provide the installer with interview questions and answers relating to the cooling unit, skipping those queries related to other components not affected by the installation.

FIG. 12 is a flow diagram of an illustrative method 1100 of programming configuration information within a controller. The method 1100 can begin generally at block 1102 in which an installation mode of the controller is activated to permit an installer to configure the controller to operate with one or more system components. Initiation of the installation mode can occur, for example, by the installer selecting an installation mode button on a touchscreen or keypad of the user interface, or automatically when the controller is activated for the first time or when one or more system components are connected to the controller.

Once the installation mode has been initiated, the controller can then be configured to provide one or more interview questions to the installer via the user interface, as indicated generally by block 1104. The interview questions provided can be configured to solicit information from the installer regarding the type and configuration of the various system components to be controlled by the controller. In certain embodiments, for example, the interview questions can include a sequence of interview questions relating to the type of equipment to be controlled, the number of heat stages the equipment has, the number of cooling stages the equipment has, the number of cycles per hour each stage of heating requires, and the number of cycles per hour each stage of cooling requires.

In some embodiments, other interview questions pertaining to the type or configuration of the controller and/or any system components controlled by the controller can be further presented to the installer via the user interface. Examples of other interview questions can include, but are not limited to, the minimum operating time desired to operate the system, whether a pump exercise is to be enabled for any installed heat pumps, the upper temperature limit at which to operate the system, the lower temperature limit at which to operate the system, the temperature offset at which the controller operates, the proportional bandwidth of the equipment, the type and operating times of the ventilation fan employed, the type and rating of the UV lamp employed, and the type and rating of the humidifier or dehumidifier employed. Other interview questions relating to the user's preferences such as the date and time format, daylight savings options, schedule programming options, temperature display options, etc. can also be provided, if desired. It should be understood that the types of interview questions and their ordering will vary depending on the type of equipment to be controlled.

The interview questions may be provided to the installer in the form of natural language questions, which may be phrases having one or more words that prompt the installer to select between one or more answers from a predetermined list of

16

answers. For example, the interview questions can include a question such as "What type of equipment is the thermostat controlling?" In some embodiments, one or more of the interview questions may elicit an affirmative "YES" or "NO" user response. Alternatively, or in addition, one or more of the interview questions can solicit information requiring a numeric or alphanumeric user response.

With certain interview questions, and in some embodiments, the controller can be configured to prompt the installer to select between at least two answers or responses displayed on the display screen of the user interface, as indicated generally by block 1106. For example, in response to the interview question "What type of equipment is the thermostat controlling?", the user interface can be configured to display the answers "Conventional", "Heat Pump", and "Heat Only", prompting the installer to select the appropriate type of equipment to be installed and/or configured. The user interface can then be configured to accept the user responses to each of the questions and then modify the operational parameters of the controller based on the user responses, as indicated generally by blocks 1108 and 1110, respectively.

In some embodiments, the user interface can be configured to display each of the answers simultaneously on the display screen of the user interface. In such configuration, the selection of a user response at block 1108 can be accomplished by the installer selecting an answer to the interview question from a list of multiple answers graphically displayed on the screen. In those embodiments in which the user interface includes a touchscreen, for example, the selection of a response can be accomplished directly by pressing the desired answer from a choice of answers provided on the screen, causing the controller to store that parameter and cycle to the next interview question in the queue. Alternatively, in those embodiments in which the user interface includes an LCD or dot matrix screen, the selection of the desired answer from the choice of answers can be accomplished via a button, knob, slide, keypad, or other suitable selector means on the user interface.

The user interface can vary the presentation of the interview questions based at least in part on the installer's previous responses to other interview questions. If, for example, the installer selects on the user interface that the type equipment being installed is "Heat Only", the interview question generator can be configured to skip those questions pertaining to the stages and cycle times for cooling. The ordering of the interview questions can also be varied based on the particular piece of equipment being configured. If, for example, the installation mode at block 1102 is initiated in response to a new piece of equipment connected to the controller, the interview question generator can be configured to present to the installer only those questions pertaining to the new equipment.

The interview question generator can also be configured to suggest a default answer based on any previous responses, based on any previous controller settings, and/or based on settings which are commonly selected for that particular piece of equipment. For example, with respect to the selection of the number of stages for heating, the user interface can be configured to default to a common answer or response of "2" while providing the installer with the ability to select among other numbers of heating stages (e.g., "0", "1", "3", "4", "5", "6", etc.), if desired. The suggestion of a default answer can be accomplished, for example, by highlighting or flashing the answer on the display screen, by moving a selection indicator adjacent to the answer on the display screen, or by other suitable means.

17

FIGS. 13A-13J are schematic drawings of an illustrative HVAC touchscreen interface **1200** showing an illustrative implementation of the flow diagram depicted in FIG. 12. In a first view depicted in FIG. 13A, the interface **1200** can be configured to display a main installation menu screen **1202** on the display panel **1204**, providing the installer with the choice of configuring one or more HVAC system components. The main installation menu screen **1202** can include, for example, a "FULL SET-UP" icon button **1206**, a "COMPONENT BASED SET-UP" icon button **1208**, and a "MANUAL SET-UP" icon button **1210**.

The "FULL SET-UP" icon button **1206** can be selected on the display panel **1204** to permit the installer to fully configure the controller to work with the system components for the first time, or when the installer otherwise desires to cycle through each of the interview questions in sequence. The "COMPONENT BASED SET-UP" icon button **1208**, in turn, can be selected to permit the installer to configure only certain system components or to configure the system in a different order than that normally provided by the interface **1200**. The "MANUAL SET-UP" icon button **1210** can be selected to permit the installer to configure the controller manually using numeric or alphanumeric codes, if desired.

FIG. 13B is a schematic drawing showing the selection of the "FULL SET-UP" icon button **1206** on the main installation menu screen **1202** of FIG. 13A. As shown in FIG. 13B, the selection of icon button **1206** causes the interface **1200** to display a language setup screen **1212** that prompts the installer to select a desired language format for the remainder of the installation configuration. The interface **1200** can be configured to display, for example, an "ENGLISH" icon button **1214**, an "ESPAÑOL" icon button **1216**, and a "FRANCAIS" icon button **1218**. Other language choices can also be displayed on the language setup screen **1212**, if desired. A "BACK" icon button **1220** and "ENTER" icon button **1222** can be provided on the display panel **1204** to permit the installer to move back to the prior screen or to enter the current setting selected and move forward to the next question in the queue. A "QUIT" icon button **1224** can be provided on the display panel **1204** to permit the installer to quit the installation configuration mode, save any changes made, and then return the controller to normal operation.

FIG. 13C is a schematic view showing the interface **1200** after the selection of the "ENGLISH" icon button **1214** on the language setup screen **1212** of FIG. 13B. As shown in FIG. 13C, once the installer has selected a desired language, the interface **1200** can be configured to display an equipment type screen **1226** allowing the installer to select the type of equipment to be configured. In some embodiments, for example, the equipment type screen **1226** may prompt the installer to select among a "CONVENTIONAL" icon button **1228**, a "HEAT PUMP" icon button **1230**, or a "HEAT ONLY" icon button **1232** each simultaneously displayed on the display panel **1204**.

Once the installer has selected the desired equipment to be installed via the equipment type screen **1226**, and as further shown in FIG. 13D, the interface **1200** can be configured to display a screen **1236** prompting the installer to select the number of heat stages to be configured, if any. Several numeric icon buttons **1238** can be provided on the screen **1236** to permit the installer to select the desired number of heat stages to be controlled. If, for example, the equipment to be configured has 2 stages of heating, the installer may select a "2" icon button **1238a** on the screen **1236**. Conversely, if the equipment to be configured has no heating stages, the installer may select a "0" icon button **1238b** on the display screen **1236**,

18

causing the interface **1200** to thereafter skip those interview questions pertaining to heating stages and cycles.

Once the number of heat stages has been configured via screen **1236**, and as further shown in FIG. 13E, the interface **1200** can be configured to display another screen **1240** prompting the installer to select the number of cooling stages to be configured, if any. Several numeric icon buttons **1242** can be provided simultaneously on the screen **1240** to permit the installer to select the desired number of cooling stages. If, for example, the equipment to be configured has 2 stages of cooling, the installer may select a "2" icon button **1242a** on the screen **1240**. Depending on the response to the previous interview question on screen **1236** of FIG. 13D, the interface **1200** can be configured to default to a particular answer (e.g. "2") by blinking or flashing the answer on the screen **1240**. In some cases, the interface **1240** may assume that the number of cooling stages is the same as the number of heating stages and skip screen **1240** altogether.

FIG. 13F is a schematic view showing the interface **1200** subsequent to the steps of configuring the heating and cooling stages in FIGS. 13D-13E. As shown in FIG. 13F, the interface **1200** can be configured to provide a screen **1244** initially prompting the installer to select a desired number of cycles per hour for the first stage of heating. Several numeric icon buttons **1246** can be provided simultaneously on the screen **1244** to permit the user to select the cycle rate at which the system operates for the particular stage number **1248** displayed on the screen **1244**. For the first stage of heating for a two-stage system, for example, the installer may select the "6" icon button **1246a** to operate the first heating stage for six cycles per each hour. Once a response is received for the first heating cycle, the interface **1200** may then prompt the installer to select the number of cycles for the second heating stage, as further shown in FIG. 13G. The process can be repeated one or more times depending on the number of heating stages to be configured.

FIG. 13H is a schematic view showing the presentation of another screen **1250** on the interface **1200** for selecting the cycle rate for each cooling stage to be configured within the controller. Similar to the screen **1244** depicted in FIGS. 13F-13G, the screen **1250** may prompt the installer to initially select a desired number of cycles per hour for the first stage of cooling, and then repeat the interview process for each additional stage to be programmed, if any. Several numeric icon buttons **1252** can be provided simultaneously on the screen **1250** to permit the installer to select the cycle rate at which the system operates for the particular stage number **1254** displayed on the screen **1250**. Once the installer has completed configuring each stage of heating and cooling, the interface **1200** can be configured jump to additional interview questions for any other components to be configured, or, alternatively, can exit the routine and return to normal operation using the newly programmed settings.

Once programming is complete, and as further shown in FIG. 13I, the interface **1200** can be configured to display a screen **1256** indicating that the configuration was successful along with a "VIEW SETTINGS" icon button **1258** allowing the installer to view the controller settings. A "BACK" icon button **1260** can be selected if the installer desires to go back and modify or change any settings. A "DONE" icon button **1262**, in turn, can be selected by the installer to return the controller to normal operation.

Referring back to FIG. 13A, if the installer desires to configure only selective components of the system, or prefers to enter configuration information in an order different than that generated by the interview question generator, the installer may select the "COMPONENT BASED SET-UP" icon but-

ton 1208 on the main installation menu screen 1202. When selected, the interface 1200 can be configured to display a component selection screen 1264, allowing the installer to select from among several different categories of equipment for configuration, as shown in FIG. 13J. The component selection screen 1264 can include, for example, a “HEATING” icon button 1266, a “COOLING” icon button 1268, a “VENTILATION” icon button 1270, a “FILTRATION” icon button 1272, a “UV LAMP” icon button 1274, a “HUMIDIFICATION” icon button 1276, and a “DEHUMIDIFICATION” icon button 1278. The icon buttons can correspond, for example, to the system components described above with respect to FIG. 9, although other combinations of system components are contemplated. An “OTHER” icon button 1280 provided on the screen 1264 can be selected by the installer to configure other system components such as any sensors or other connected controllers, if desired.

The selection of the icon buttons on the component selection screen 1264 causes the interface 1200 to display one or more interview questions and answers on the display panel 1204 based on the type of equipment to be configured. If, for example, the installer desires to configure only the heating and cooling system components, the installer may select both the “HEATING” icon button 1266 and “COOLING” icon button 1268 on the screen 1264, causing the user interface 1200 to present only those interview questions that pertain to heating and cooling control. The process of providing the installer interview questions and answers in multiple-choice format can then be performed in a manner similar to that described above with respect to FIGS. 13C-13H. If desired, the process can be performed for any other system component or components to be configured.

The present invention should not be considered limited to the particular examples described above, but rather should be understood to cover all aspects of the invention as fairly set out in the attached claims. Various modifications, equivalent processes, as well as numerous structures to which the present invention can be applicable will be readily apparent to those of skill in the art to which the present invention is directed upon review of the instant specification.

What is claimed is:

1. A method of programming configuration information of an HVAC controller, wherein the configuration information is related to characteristics of one or more system components of an HVAC system to be controlled by the HVAC controller, the HVAC controller is configured to use the configuration information to properly control the one or more system components of the HVAC system to be controlled by the HVAC controller, the method comprising the steps of:

displaying one or more grammatically complete sentences on a user interface of the HVAC controller, the one or more grammatically complete sentences soliciting a response from a user related to configuration information of the HVAC system, wherein the configuration information is related to characteristics of one or more system components of the HVAC system to be controlled by the HVAC controller;

in response to displaying at least one of the grammatically complete sentences on the user interface, allowing the user to select between at least two responses simultaneously displayed on the user interface;

accepting a user selection;

modifying the configuration information of the HVAC controller based at least in part on said accepted user selection; and

using the modified configuration information of the HVAC controller when controlling one or more system components of the HVAC system.

2. The method according to claim 1, wherein the displaying step comprises displaying one or more grammatically complete sentences that include a natural language question.

3. The method according to claim 1, wherein the displaying step comprises displaying one or more grammatically complete sentences that are phrases.

4. The method according to claim 1, wherein the user interface includes a touch screen, and where said step of allowing the user to select between at least two responses simultaneously displayed on the touch screen includes the step of allowing the user to select between responses directly on the touch screen.

5. The method according to claim 1, wherein the user interface is an LCD or dot matrix screen, and wherein said step of allowing the user to select between at least two responses simultaneously displayed on the LCD or dot matrix screen includes the step of allowing the user to select between responses via a selector displayed on the user interface.

6. The method according to claim 1, wherein the modifying step includes modifying configuration information related to a heating unit.

7. The method according to claim 1, wherein the modifying step includes modifying configuration information related to a cooling unit.

8. The method according to claim 1, further comprising the step of varying the presentation of the one or more grammatically complete sentences to the user based at least in part on a previous user selected response.

9. The method according to claim 1, wherein the allowing step includes the step of providing a default response on the user interface for confirmation by the user.

10. The method according to claim 1 wherein the displaying step comprises displaying one or more grammatically complete sentences that include punctuation.

11. A method of programming configuration information of an HVAC controller, wherein the HVAC controller is configured to use the configuration information when controlling one or more system components of an HVAC system, the method comprising the steps of:

displaying a first query in the form of a grammatically complete sentence to a user via a user interface of the HVAC controller while not displaying a second query, the first query soliciting configuration information from the user, wherein the configuration information is related to characteristics of one or more system components of the HVAC system to be controlled by the HVAC controller;

accepting one or more user responses to the first query via the user interface;

after accepting the one or more user responses to the first query, displaying the second query in the form of a grammatically complete sentence to a user via a user interface of the HVAC controller while not displaying the first query, the second query soliciting different configuration information from the user;

accepting one or more user responses to the second query via the user interface;

modifying the configuration information of the HVAC controller based at least in part on the one or more user responses to the first and second queries; and

using the modified configuration information of the HVAC controller when controlling one or more HVAC components of an HVAC system.

21

12. The method according to claim 11 wherein at least one of the first query and the second query include punctuation.

13. The method according to claim 11, wherein the user interface is a touch screen, and where the step of accepting one or more user responses includes the step of allowing the user to select between two or more responses directly on the touch screen.

14. The method according to claim 11, wherein the user interface is an LCD or dot matrix screen, and wherein said step of accepting one or more user responses includes the step of allowing the user to select between two or more responses via a selector displayed on the user interface.

15. The method according to claim 11, wherein the modifying step includes modifying configuration information related to a heating unit.

16. The method according to claim 11, wherein the modifying step includes modifying configuration information related to a cooling unit.

17. A method of programming configuration information for an HVAC controller, wherein the HVAC controller is configured to control different types of HVAC system components and to use the programmed configuration information to properly control the one or more HVAC system components, the method comprising the steps of:

displaying a first query in the form of a grammatically complete sentence to a user via a user interface of the

22

HVAC controller while not displaying a second query, the first query requesting information regarding a type of system component to be controlled by the controller; allowing the user to select between at least two types of system components to be controlled by the controller; accepting a first selection by the user; after accepting the first selection, displaying a second query in the form of a grammatically complete sentence to a user via the user interface while not displaying the first query, the second query requesting additional information regarding the selected type of system component selected in the first selection; allowing the user to select between at least two second responses relating to additional information regarding the selected type of system component made by the user in the first selection; accepting a second selection by the user; modifying the configuration information of the HVAC controller based at least in part on said first and second selections; and using the modified configuration information of the HVAC controller when controlling one or more HVAC components of an HVAC system.

18. The method according to claim 17 wherein at least one of the first query and the second query include punctuation.

* * * * *