

EXHIBIT B



US006529824B1

(12) **United States Patent**
Obradovich et al.

(10) **Patent No.: US 6,529,824 B1**
(45) **Date of Patent: *Mar. 4, 2003**

(54) **PERSONAL COMMUNICATION SYSTEM FOR COMMUNICATING VOICE DATA POSITIONING INFORMATION**
(75) Inventors: **Michael L. Obradovich**, San Clemente; **John Dinkel**, Irvine; **Michael Kent**, Garden Grove, all of CA (US)

(73) Assignee: **American Calcar, Inc.**, Wilmington, DE (US)

(*) Notice: This patent issued on a continued prosecution application filed under 37 CFR 1.53(d), and is subject to the twenty year patent term provisions of 35 U.S.C. 154(a)(2).

Subject to any disclaimer, the term of this patent is extended or adjusted under 35 U.S.C. 154(b) by 0 days.

(21) Appl. No.: **09/669,527**

(22) Filed: **Sep. 25, 2000**

Related U.S. Application Data

(62) Division of application No. 08/879,955, filed on Jun. 20, 1997, now Pat. No. 6,148,261.

(51) **Int. Cl.⁷** **G06F 7/00**

(52) **U.S. Cl.** **701/208**; 340/995; 342/357.1; 342/457; 455/456; 455/461

(58) **Field of Search** 701/207, 208, 701/209, 213, 300; 340/944, 945, 961, 971, 979, 988, 989, 990, 995, 286.01, 286.06; 342/352, 357.1, 457; 455/433, 437, 438, 439, 440, 459, 461, 456, 457

(56) **References Cited**

U.S. PATENT DOCUMENTS

4,350,970 A 9/1982 von Tomkewitsch
4,521,857 A 6/1985 Reynolds, III
4,792,803 A 12/1988 Madnick et al.

4,812,843 A 3/1989 Champion et al. 340/905
4,977,509 A 12/1990 Pitchford et al. 701/200
5,023,934 A 6/1991 Wheelless
5,043,736 A 8/1991 Darnell et al. 342/357
5,119,504 A 6/1992 Durboraw, III 455/54.1
5,124,915 A 6/1992 Krensel 364/420
5,127,674 A 7/1992 Lamphere et al.
5,164,904 A 11/1992 Summer
5,189,632 A 2/1993 Paajanen et al.
5,225,843 A 7/1993 Thompson
5,235,633 A 8/1993 Dennison et al. 379/60
5,265,024 A 11/1993 Crabill et al.

(List continued on next page.)

OTHER PUBLICATIONS

Geosystems, Home and Corporate web pages, 4 pages.
Geosystems, Products and MapRoom web pages, Products & Services, 23 pages.
Geosystems, Corporate web pages, Corporate Back-grounder, 14 pages.
WorldPages web pages, 5 pages.
DineNet web pages, 19 pages.
AAA Map'n 'Go Travel Package web pages, 7 pages.
Nokia 9000 Communicator web pages, 16 pages.

(List continued on next page.)

Primary Examiner—William A. Cuchlinski, Jr.

Assistant Examiner—Ed Pipala

(74) *Attorney, Agent, or Firm*—Christie, Parker & Hale, LLP

(57) **ABSTRACT**

A location tagged data provision and display system. A personal communication device (PCD) with electromagnetic communication capability has a GPS receiver and a display. The PCD requests maps and location tagged data from data providers and other for display on the PCD. The data providers respond to requests by using searching and sorting schemes to interrogate data bases and then automatically transmitting data responsive to the requests to the requesting PCD.

15 Claims, 31 Drawing Sheets

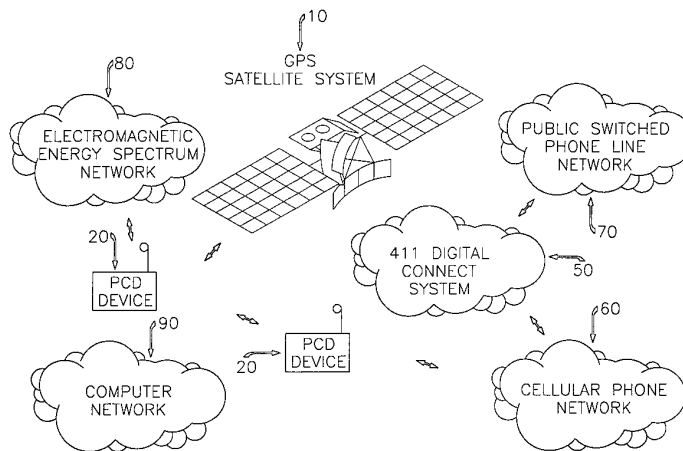

US 6,529,824 B1

Page 2

U.S. PATENT DOCUMENTS

5,267,042 A	11/1993	Tsuchiya et al.	
5,272,638 A	12/1993	Martin et al.	
5,295,064 A	3/1994	Malec et al.	
5,299,132 A	3/1994	Wortham	364/460
5,334,974 A	8/1994	Simms et al.	340/990
5,335,276 A	8/1994	Thompson et al.	380/21
5,420,592 A	5/1995	Johnson	
5,432,841 A	7/1995	Rimer	
5,450,329 A	9/1995	Tanner	364/449
5,479,351 A	12/1995	Woo et al.	
5,479,482 A	12/1995	Grimes	379/59
5,497,339 A	3/1996	Bernard	364/705.5
5,504,482 A	4/1996	Schreder, III	340/995
5,504,684 A	4/1996	Lau et al.	
5,517,193 A	5/1996	Allison et al.	
5,519,403 A	5/1996	Bickley et al.	342/352
5,523,950 A	6/1996	Peterson	
5,528,248 A	6/1996	Steiner et al.	342/357
5,528,493 A	6/1996	Potter	
5,539,645 A	7/1996	Mandhyan et al.	
5,543,789 A	8/1996	Behr et al.	340/995
5,555,286 A	9/1996	Tendler	
5,555,386 A	9/1996	Tendler	379/59
5,559,520 A	9/1996	Barzegar et al.	342/357
5,572,204 A	11/1996	Timm et al.	340/988
5,579,535 A	11/1996	Orden et al.	455/33.1
5,600,796 A	2/1997	Okamura et al.	
5,604,676 A	2/1997	Penzias	
5,625,668 A	4/1997	Loomis et al.	379/58
5,625,884 A	4/1997	Gitlin et al.	
5,627,547 A	5/1997	Ramaswamy et al.	342/357
5,627,549 A	5/1997	Park	
5,630,068 A	5/1997	Vela et al.	
5,638,279 A	6/1997	Kishi et al.	
5,640,156 A	6/1997	Okuda et al.	
5,642,285 A	6/1997	Woo et al.	
5,648,763 A	7/1997	Long	
5,648,769 A	7/1997	Sato et al.	340/988
5,652,379 A	7/1997	Fukatani	
5,654,886 A	8/1997	Zereski, Jr. et al.	
5,661,652 A	8/1997	Sprague et al.	364/449.7
5,663,548 A	9/1997	Hayashi et al.	
5,673,039 A	9/1997	Pietzsch et al.	
5,675,732 A	10/1997	Majeti et al.	
5,677,837 A	10/1997	Reynolds	364/424.028
5,680,444 A	10/1997	Reeves	
5,689,252 A	11/1997	Ayonoglu et al.	340/991
5,694,514 A	12/1997	Evans et al.	
5,699,056 A	12/1997	Yoshida	340/905
5,699,255 A	12/1997	Ellis et al.	701/212
5,719,936 A	2/1998	Hillenmayer	
5,727,053 A	3/1998	Sizer, II et al.	
5,731,997 A	3/1998	Manson et al.	
5,742,509 A	4/1998	Goldberg et al.	
5,745,855 A	4/1998	Futamura	
5,748,106 A	5/1998	Schoenian et al.	
5,760,742 A	6/1998	Branch et al.	342/457
5,774,070 A	6/1998	Rendon	340/905
5,774,825 A	6/1998	Reynolds	
5,774,827 A	6/1998	Smith et al.	701/209
5,781,150 A	7/1998	Norris	
5,786,789 A	7/1998	Janky	
5,790,974 A	8/1998	Tognazzini	702/204
5,794,174 A	8/1998	Janky et al.	
5,802,492 A	9/1998	DeLorme et al.	
5,809,247 A	9/1998	Richardson et al.	
5,815,683 A	9/1998	Vogler	
5,819,227 A	10/1998	Obuchi	
5,864,305 A	1/1999	Rosenquist	340/905
5,908,464 A	6/1999	Kishigami et al.	701/208
5,917,405 A	6/1999	Joao	
5,919,246 A	7/1999	Waizmann et al.	701/209
5,929,774 A	7/1999	Charlton	
5,938,721 A	8/1999	Dussell et al.	
5,946,626 A	8/1999	Foladare et al.	
5,948,040 A	* 9/1999	DeLorme et al.	701/201
5,950,173 A	9/1999	Perkowski	
5,963,956 A	10/1999	Smartt	707/104
5,982,298 A	11/1999	Lappenbusch et al.	340/905
5,999,124 A	12/1999	Sheynblat	
5,999,877 A	12/1999	Takahashi et al.	71/117
6,028,550 A	2/2000	Froeberg et al.	
6,047,327 A	4/2000	Tso et al.	
6,075,874 A	6/2000	Higashikubo et al.	
6,087,965 A	7/2000	Murphy	
6,092,076 A	7/2000	McDonough et al.	707/102
6,107,944 A	8/2000	Behr et al.	340/995
6,119,066 A	9/2000	Sugiura et al.	701/208
6,122,506 A	9/2000	Lau et al.	
6,124,825 A	9/2000	Eschenbach	
6,127,945 A	10/2000	Mura-Smith	
6,131,066 A	10/2000	Ahrens et al.	701/200
6,131,067 A	10/2000	Girerd et al.	
6,134,501 A	10/2000	Oumi	701/209
6,144,920 A	11/2000	Mikame	701/212
6,147,598 A	11/2000	Murphy et al.	
6,148,261 A	11/2000	Obradovich et al.	701/208
6,163,749 A	12/2000	McDonough et al.	701/208
6,163,753 A	12/2000	Beckmann et al.	
6,166,626 A	12/2000	Janky et al.	
6,169,955 B1	1/2001	Fultz	
6,173,231 B1	1/2001	Chojnacki	701/208
6,184,801 B1	2/2001	Janky	
6,185,427 B1	2/2001	Krasner et al.	455/456
6,188,957 B1	2/2001	Bechtolsheim et al.	701/209
6,192,312 B1	2/2001	Hummelsheim	701/118
6,192,314 B1	2/2001	Khavakh et al.	701/209
6,199,013 B1	3/2001	O'Shea	701/211
6,202,023 B1	3/2001	Hancock et al.	701/201
6,208,934 B1	3/2001	Bechtolsheim et al.	701/209
6,212,392 B1	4/2001	Fitch et al.	455/456
6,212,470 B1	4/2001	Seymour et al.	701/207
6,212,472 B1	4/2001	Nonaka et al.	701/208
6,212,473 B1	4/2001	Stefan et al.	701/210
6,212,550 B1	4/2001	Segur	709/206
6,219,557 B1	4/2001	Havinis	
6,219,614 B1	4/2001	Uchigaki et al.	
6,219,694 B1	4/2001	Lazaridis et al.	709/206
6,321,158 B1	11/2001	DeLorme et al.	
6,332,127 B1	12/2001	Bandera et al.	

OTHER PUBLICATIONS

Global Map 2000 web pages, 6 pages.

Demmler, "Another Car Navigation System," *Automotive Engineering*, Jun. 1996, pp. 87, 89, 2 pages.

Sedgwick, "Butterfly gives clue to cars of tomorrow," *Automotive News*, Oct. 28, 1996, p. 43, 2 pages.

Jewett, "Toyota offers navigation system as U.S. option," *Automotive News*, Nov. 18, 1996, p. 16, 2 pages.

Yamaguchi, "Honda in-car navigation system for the U.S.," *Automotive Engineering*, Jun. 1996, pp. 82-84, 3 pages.

Heuchert, "Eyes Forward: An ergonomic solution to driver information overload," *Automotive Engineering*, Sep. 1996, pp. 27-31, 5 pages.

Noriyuki, "Just Think of It as a Big Eye in the Sky . . . Watching," *Los Angeles Times*, Section E, pp. 1, 8, Apr. 27, 1997, 2 pages.

BigYellow web pages, 6 pages.

Maps On Us web pages, 14 pages.

- Maps On Us web pages, Search Categories, 14 pages.
Mapquest web pages, 1 page.
Advertisement, "Collision Avoidance is Critical . . . Now it's Affordable," 1 page.
Advertisement, "Duats," 1 page.
"Trimble Demonstrates Trimconnect," Flying, Jul. 1997, p. 51, 1 page.
Advertisement, "MFD 5200 Multi-Function Display," 1 page.
Advertisement, "SUPER Road Whiz", 2 pages.
Yoshikazu Noguchi, "Intelligent Car—History and the Future in Japan and Toyota," Toyota Motor Corporation 98C015, 5 pages.
Monet (Mobile Network), 2 pages.
Steve Dye with Dr. Frank Baylin, The GPS Manual Principles and Applications, "Land Navigation Market—Overview", Feb. 1997, ISBN:0-917893-29-8, 23 pages.
Martin Wolk, "Microsoft unveils plans for car dashboard computer," Reuters Article, Copyright date 1998.
- Edward W. Desmond, "Malone Again," Fortune Cover Stories, Publication Date Feb. 16, 1998, pp. 66, 68 & 69.
Alcatel web pages, Alcatel, Nov. 24, 1998 (58 pages).
Giga Information Group, Inc. web pages, Giga Information Group, Inc. Nov. 24, 1998 (4 pages).
Spyglass web pages, Spyglass, Nov. 24, 1998 (58 pages).
Think Thin, PC Magazine, Dec. 01, 1998 (p. 9).
McDonald, Keith D., "Course 122 –GPS Fundamentals & Applications", Navtech Seminars & GPS Supply, Inc., Cata-maran Resort Hotel, San Diego, CA, Mar. 22-23, 1999 (336 sheets).
Kelley, Tom, "Traffic Control Traffic Data, Unplugged", ITS World, Jul./Aug. 2000 (pp. 28-30).
Bishop, Richard, "The Final Stop Remember IVHS?", ITS World, Jul./Aug. 2000 (pp. 14-15).
Metricom in the News, web pages, Metricom, Inc., Nov. 24, 1998 (8 pages).

* cited by examiner

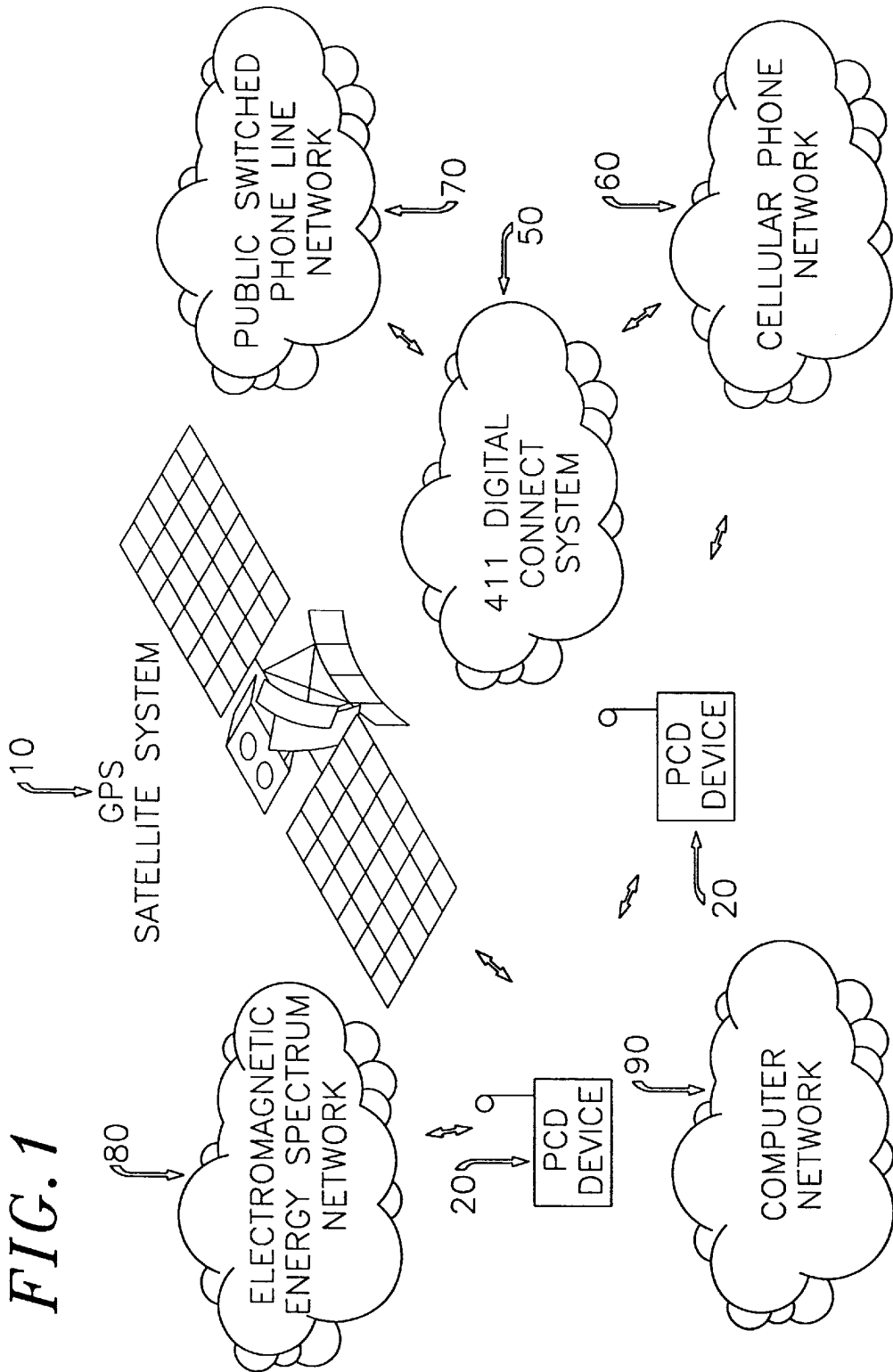

FIG. 2

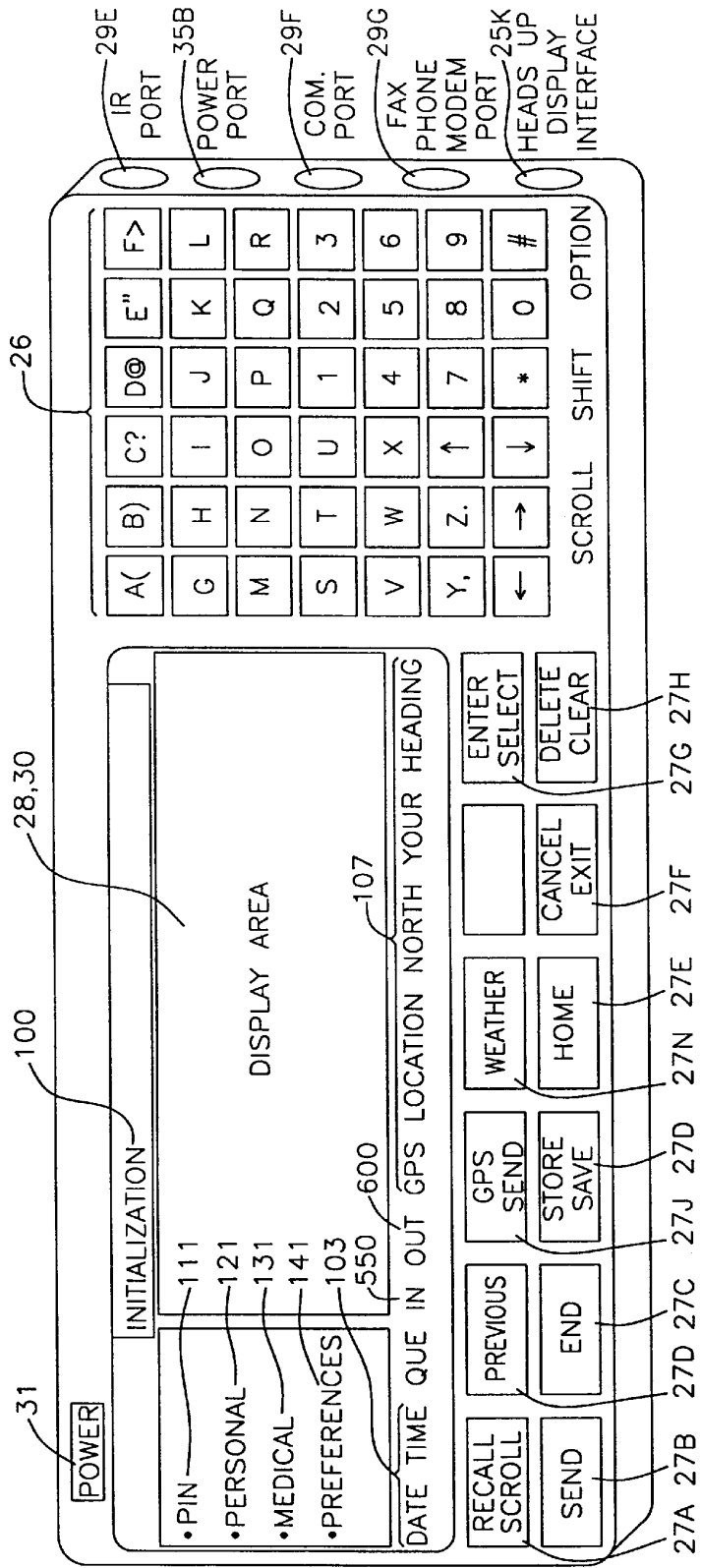

FIG. 3

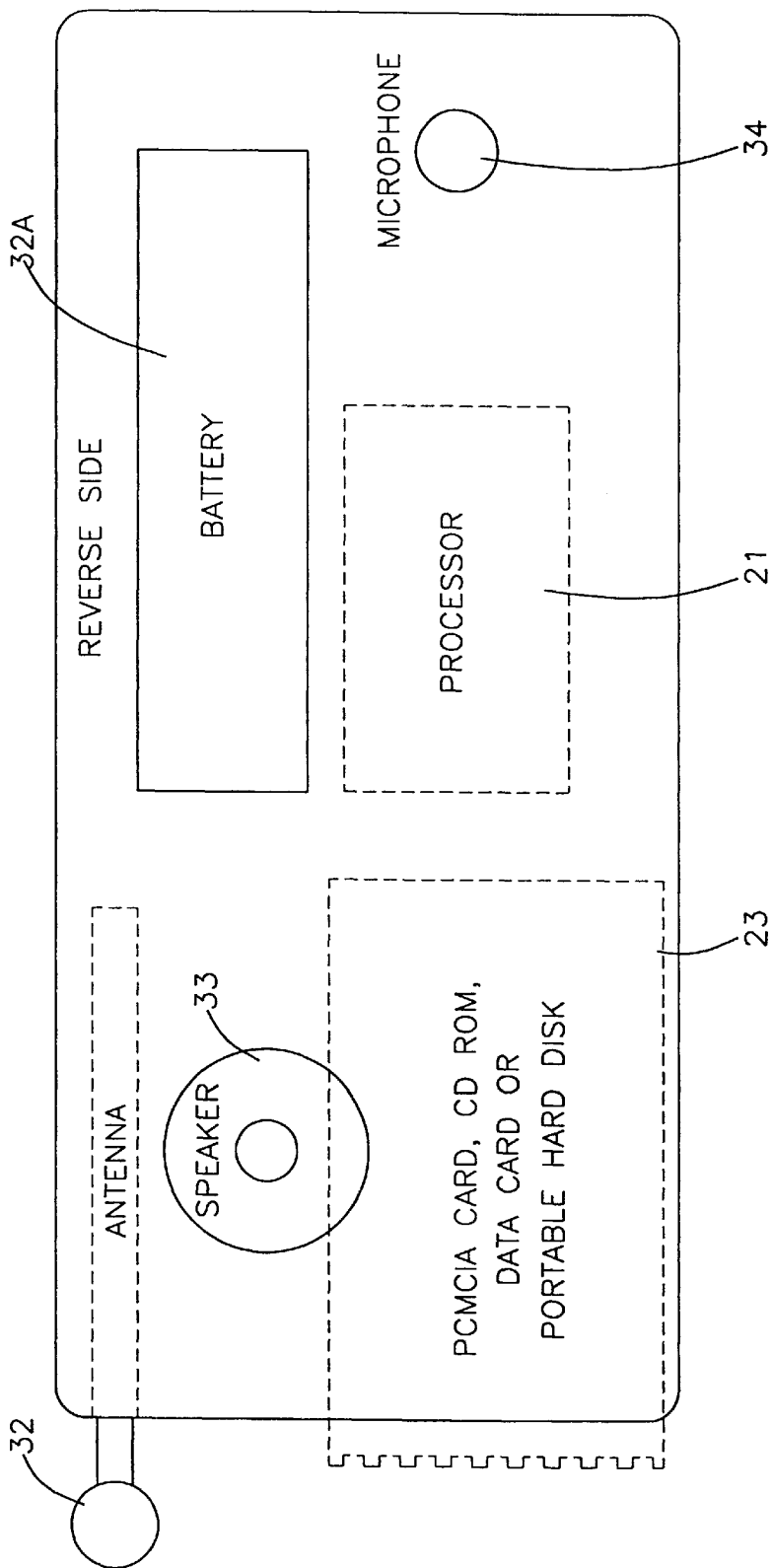

FIG. 4

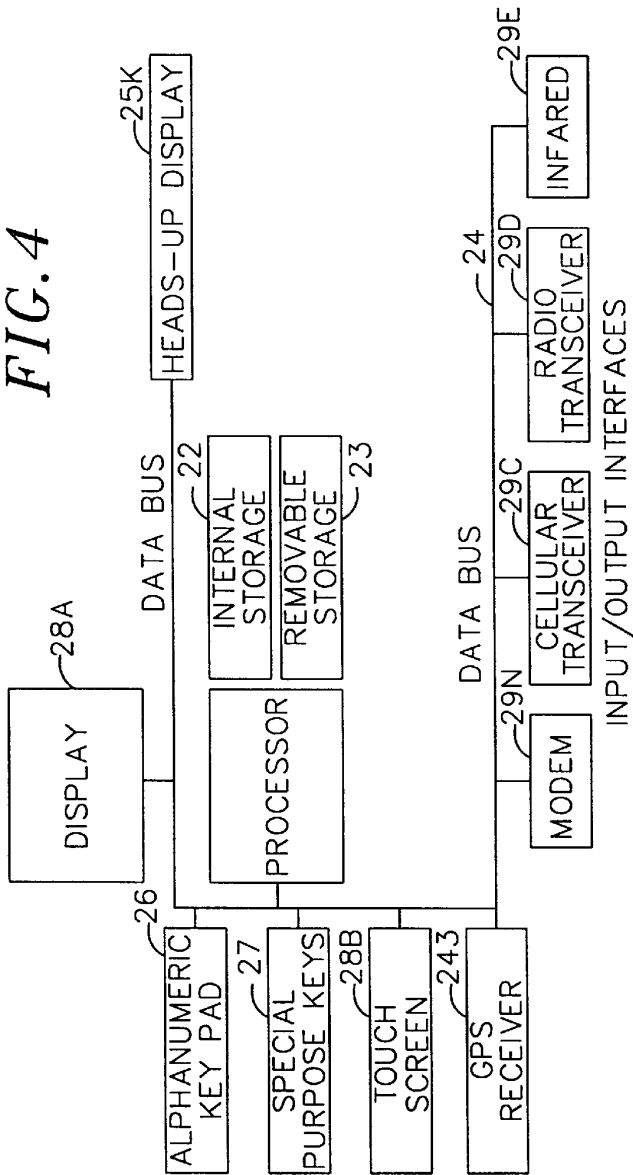

FIG. 4A

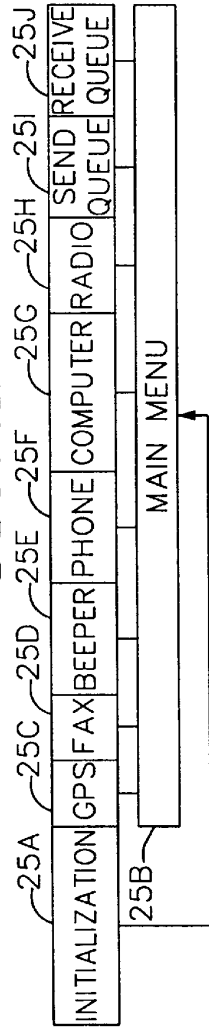
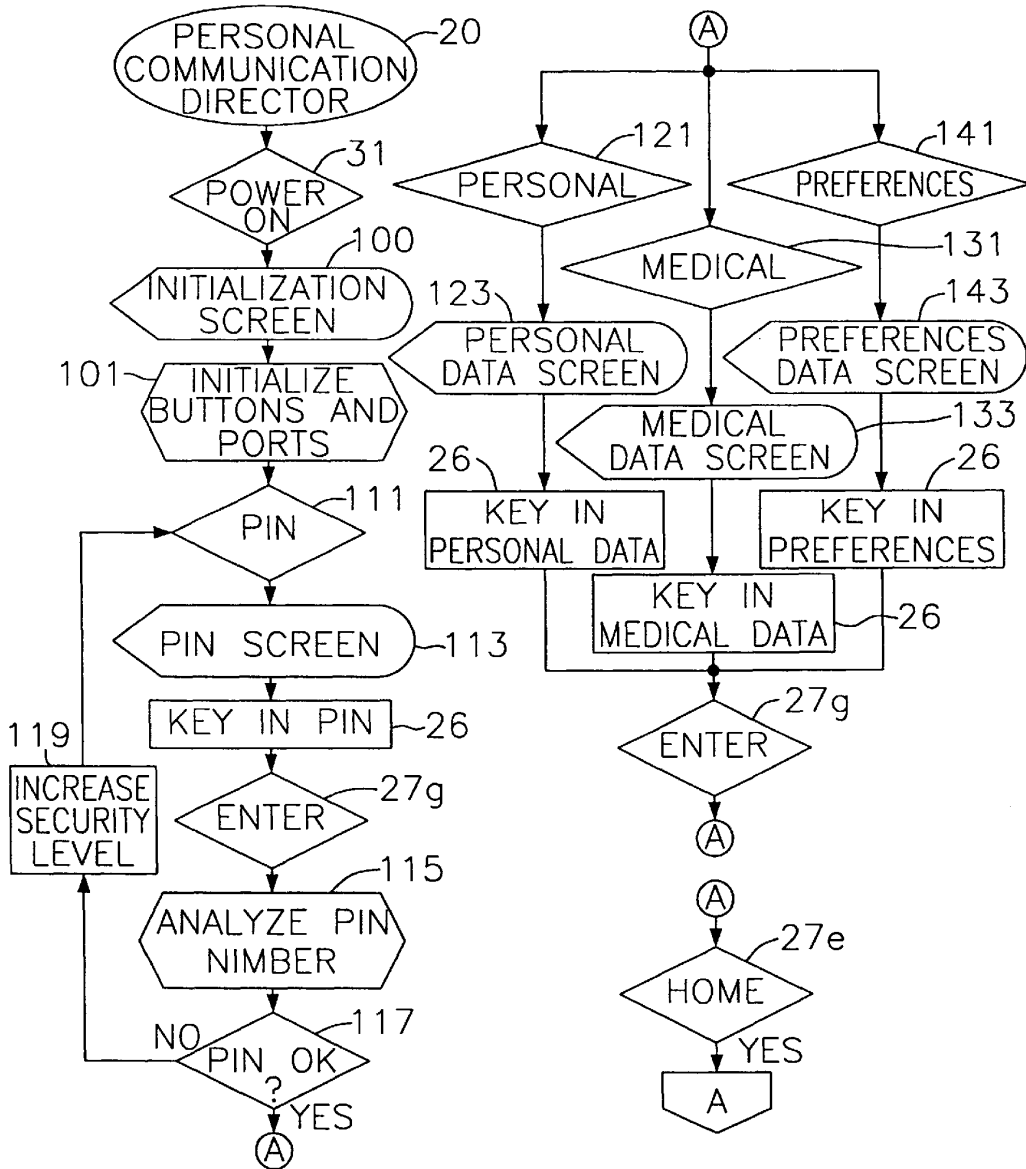
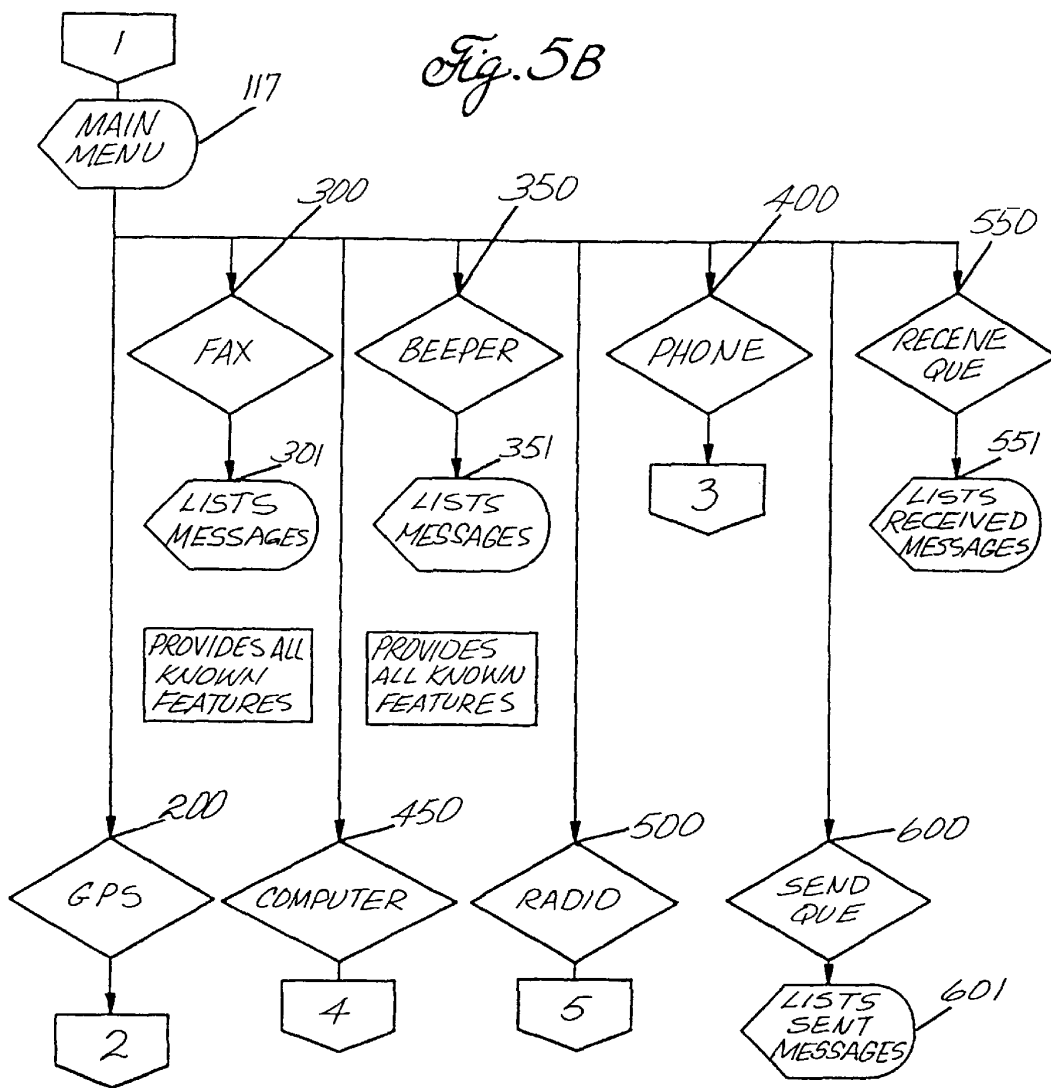

FIG. 5A





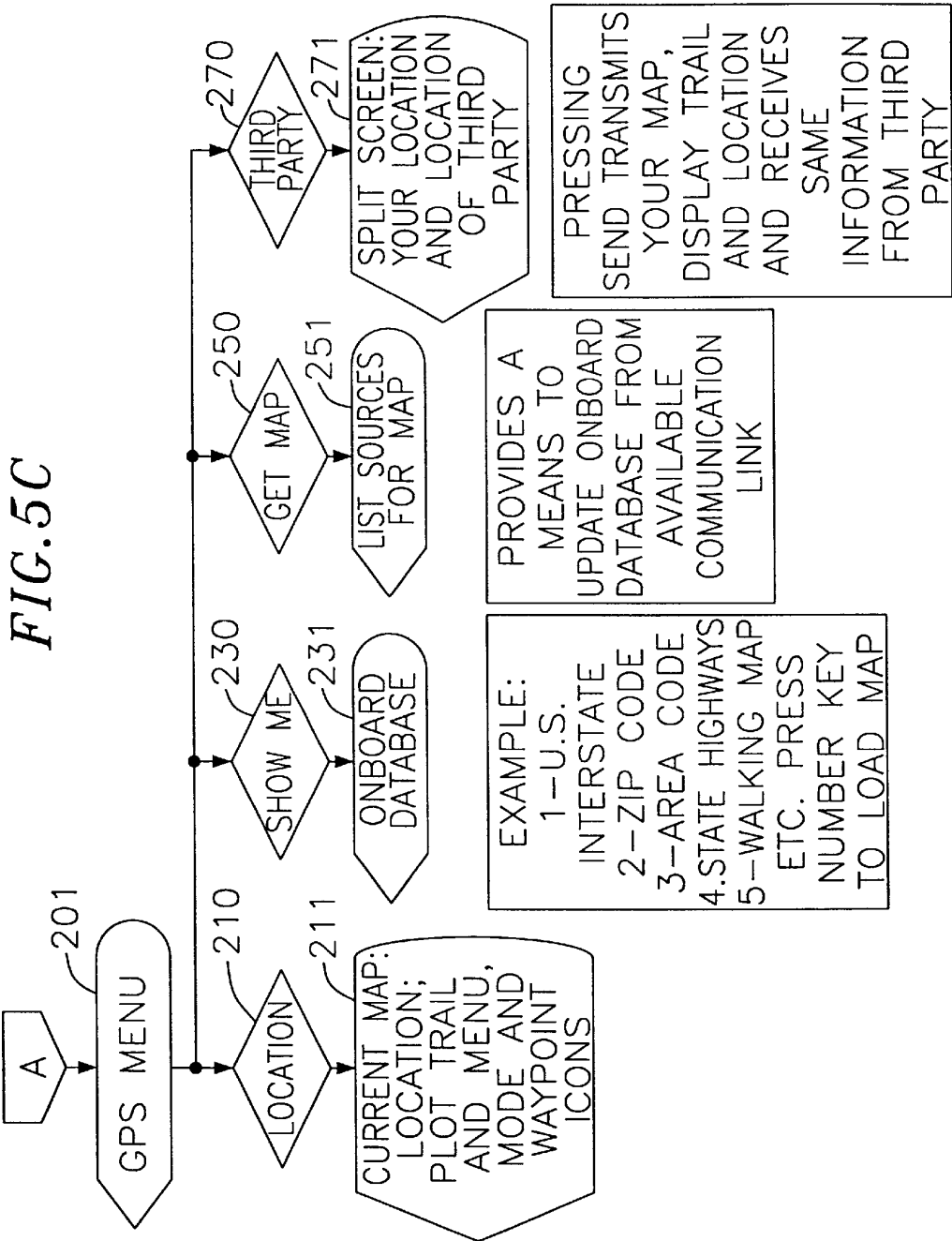
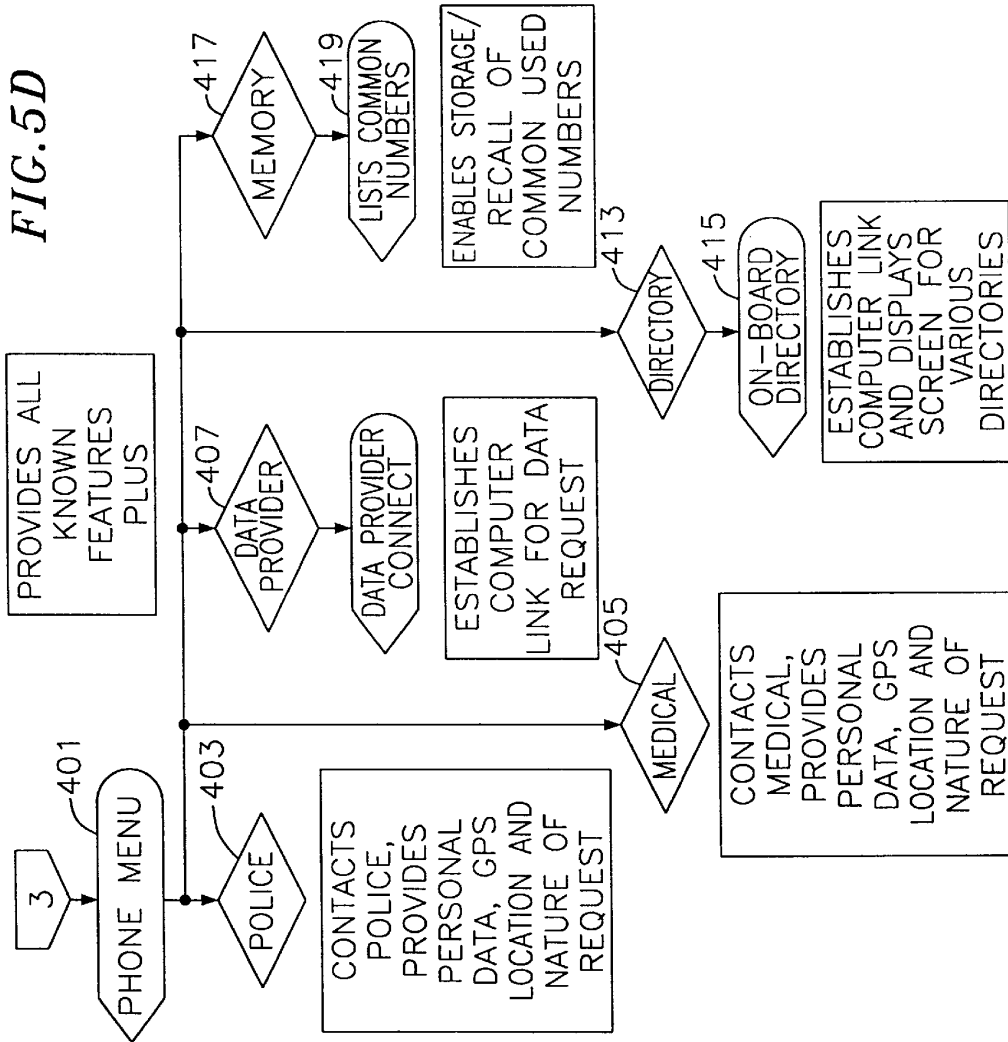
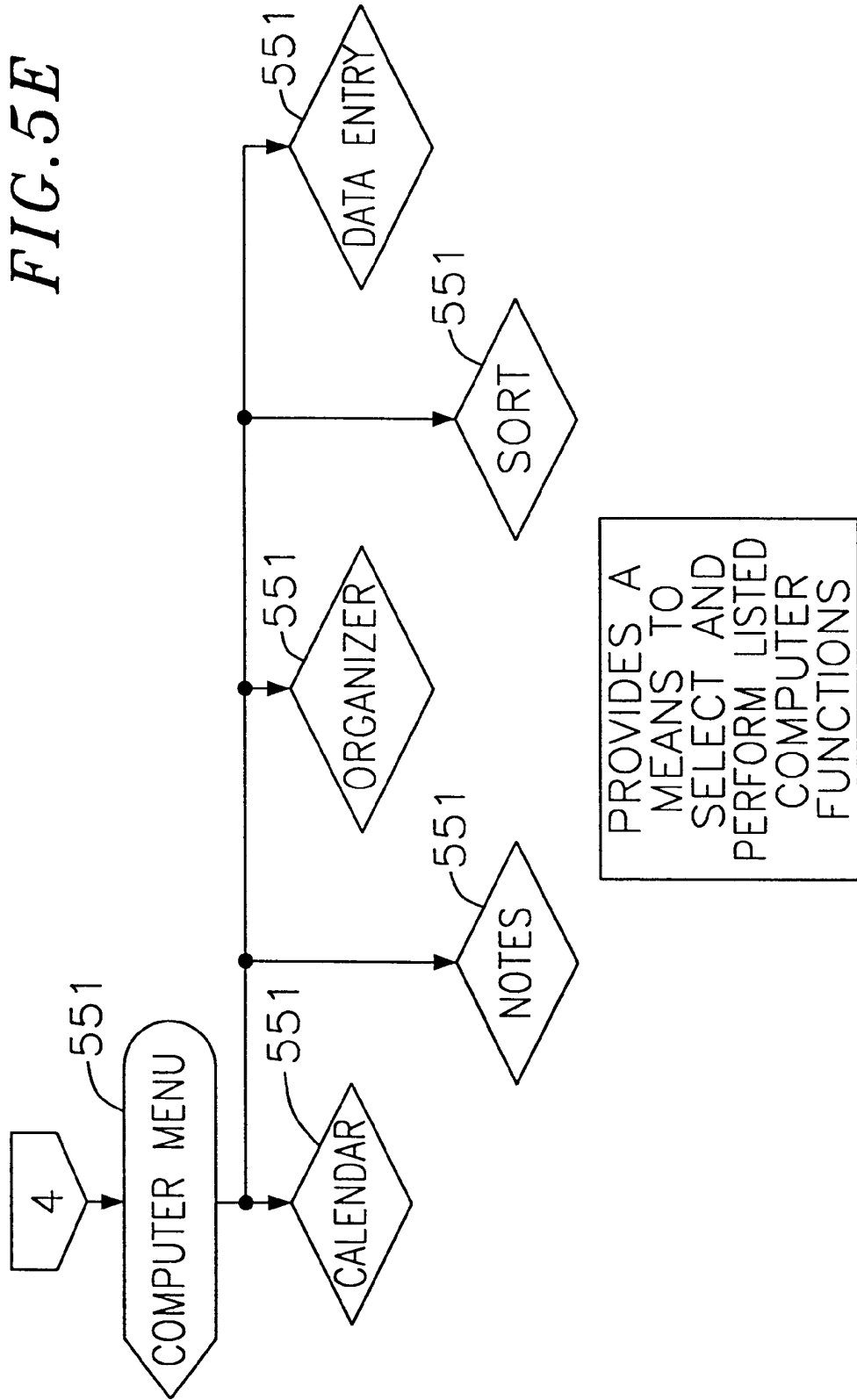

FIG. 5D





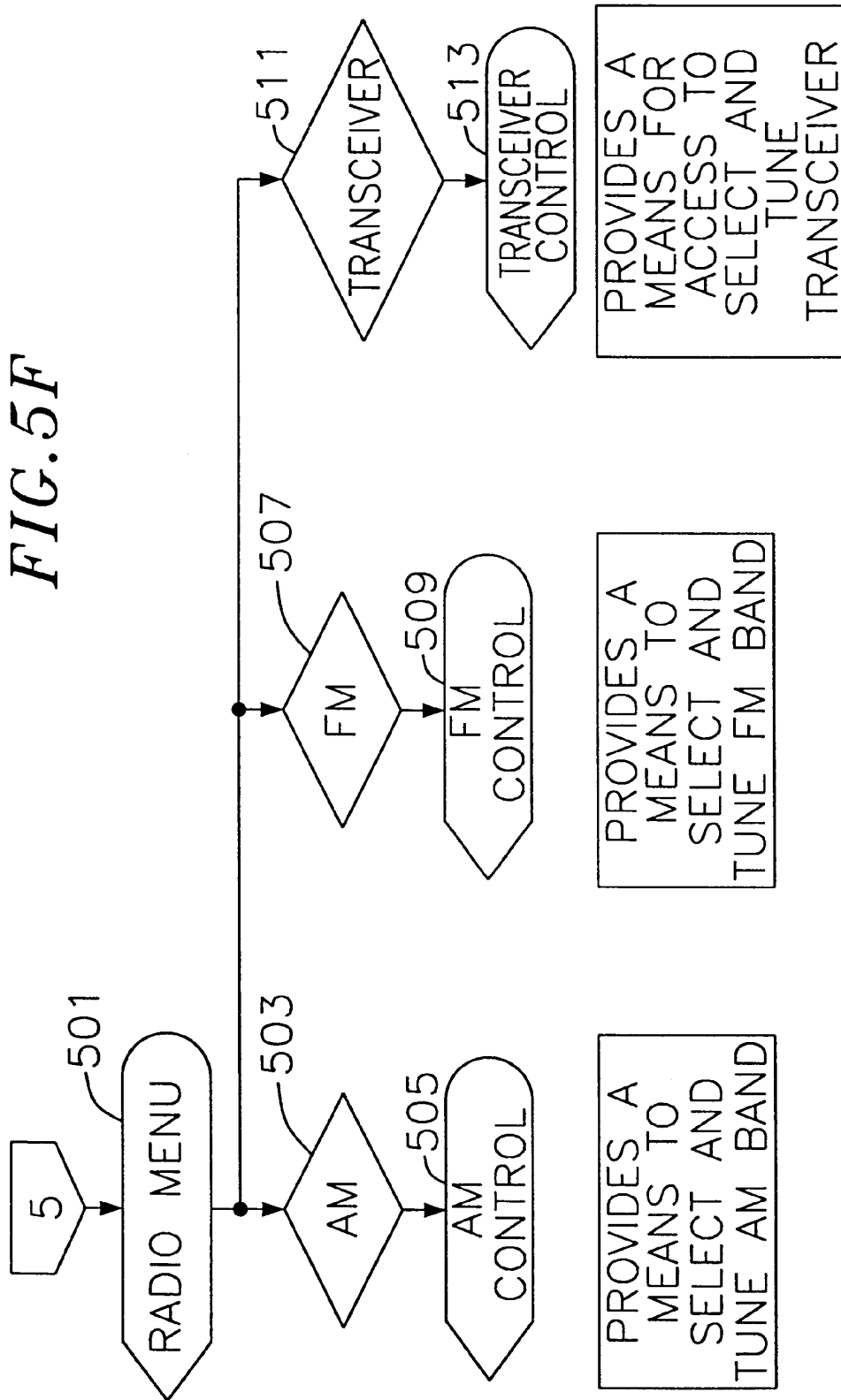

FIG. 6

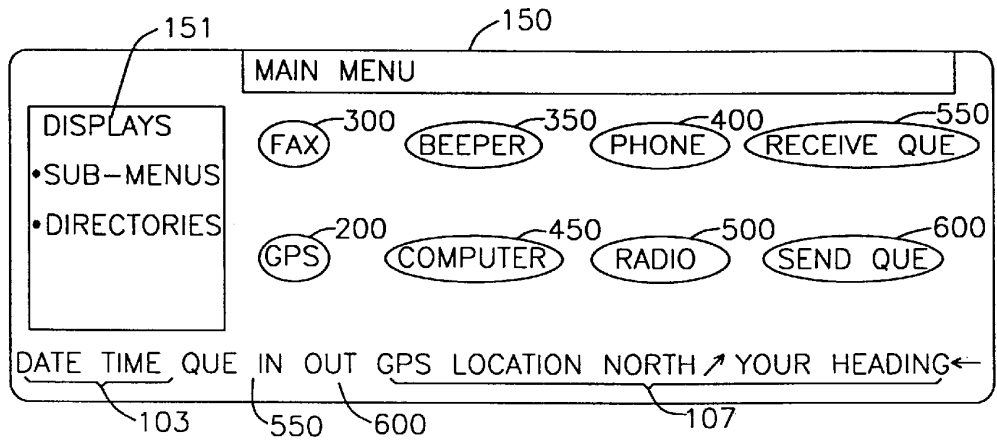

FIG. 7

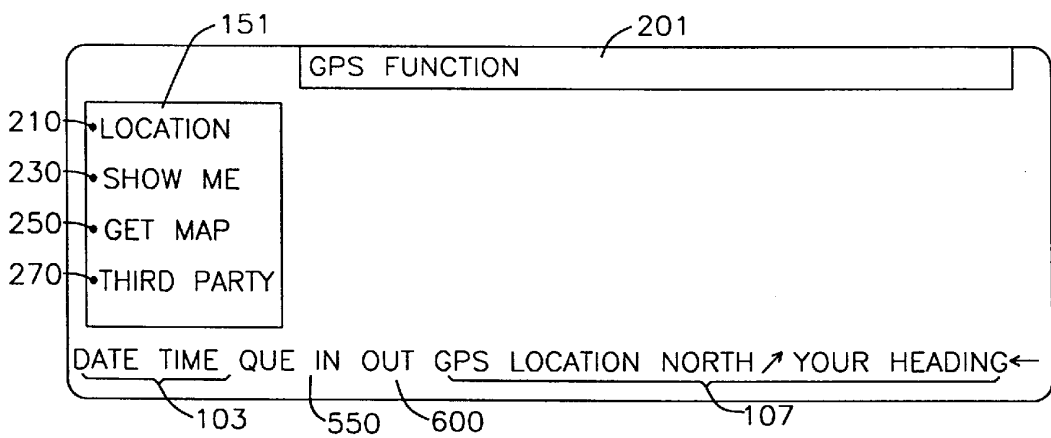

FIG. 8

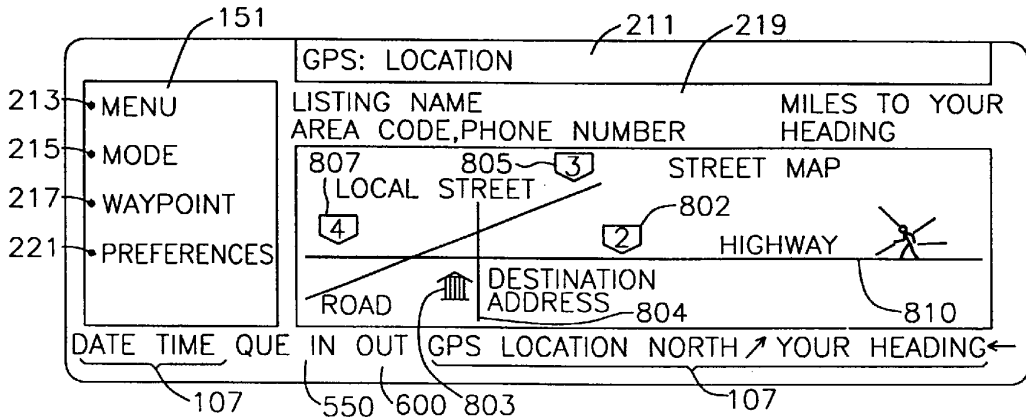

FIG. 9

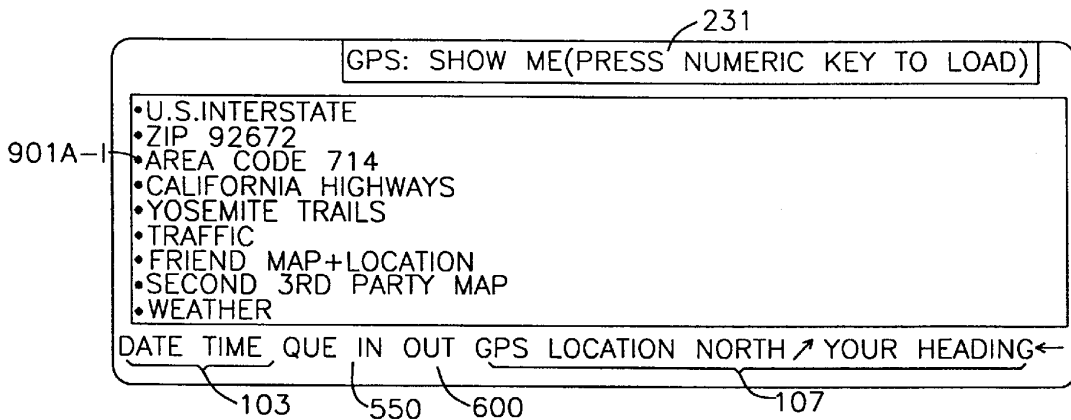

FIG. 10

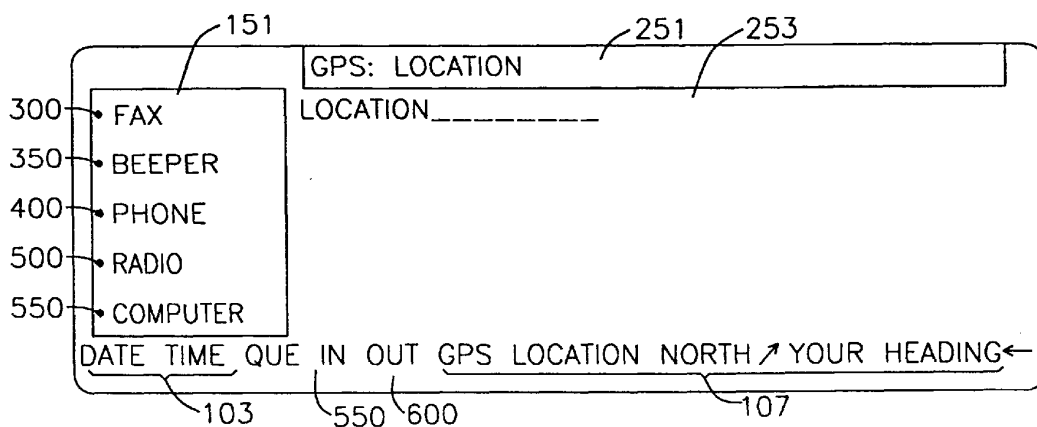

FIG. 11

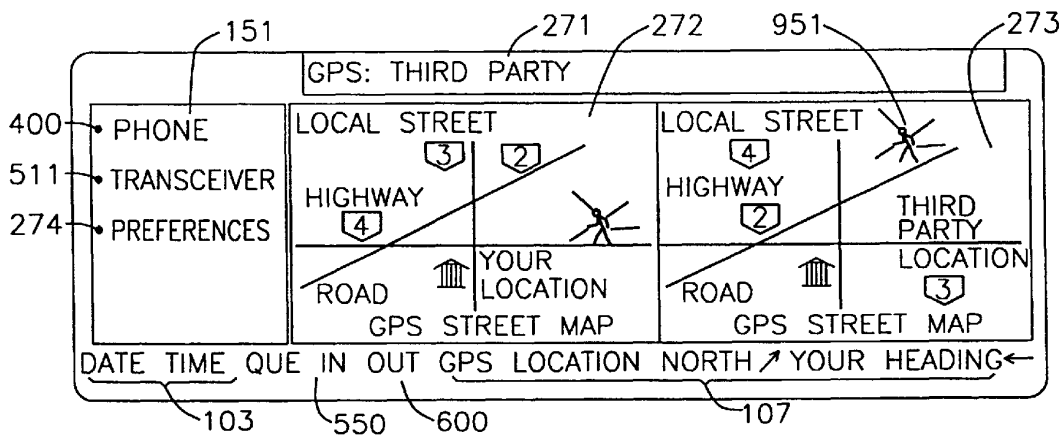

FIG. 12

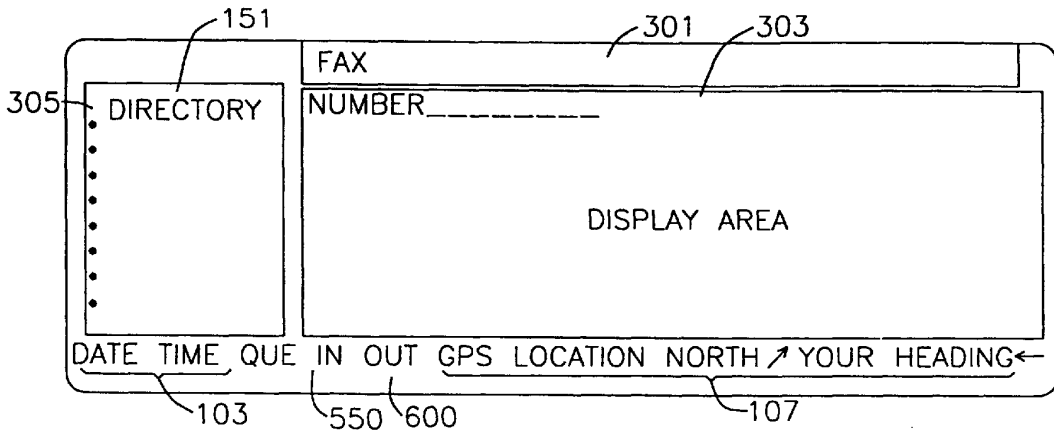

FIG. 13

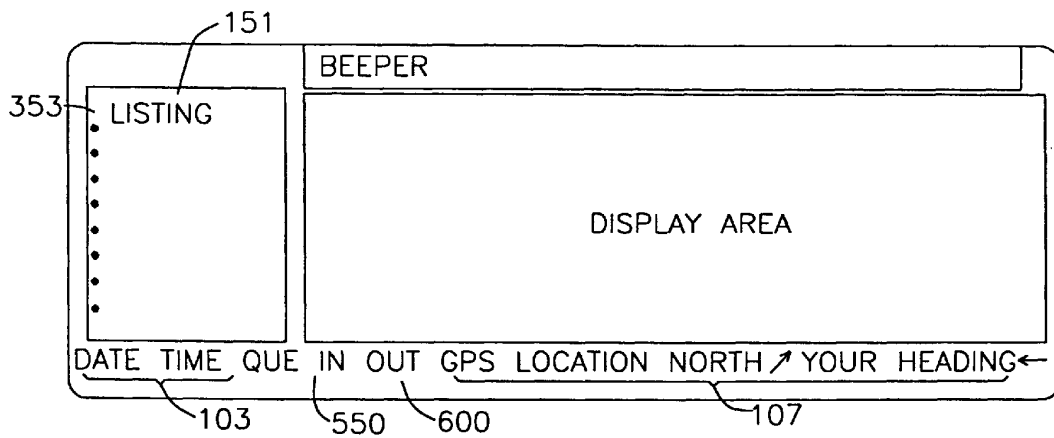

FIG. 14

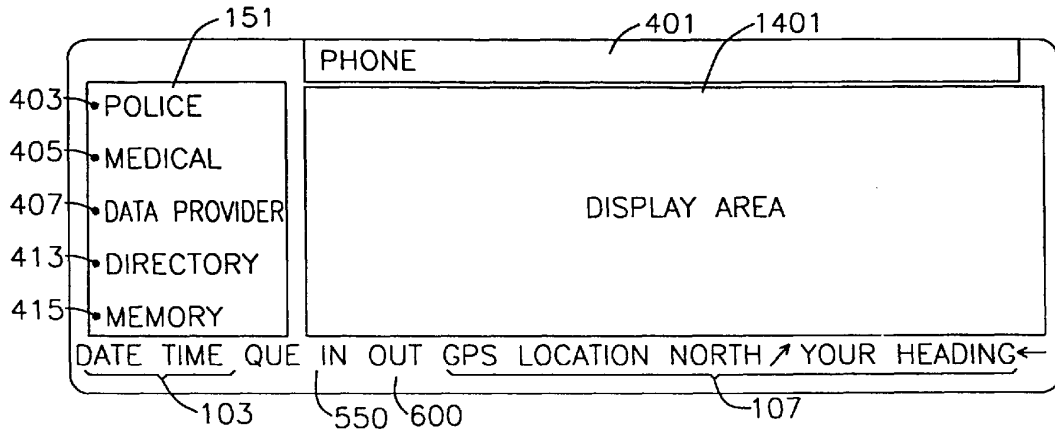

FIG. 15

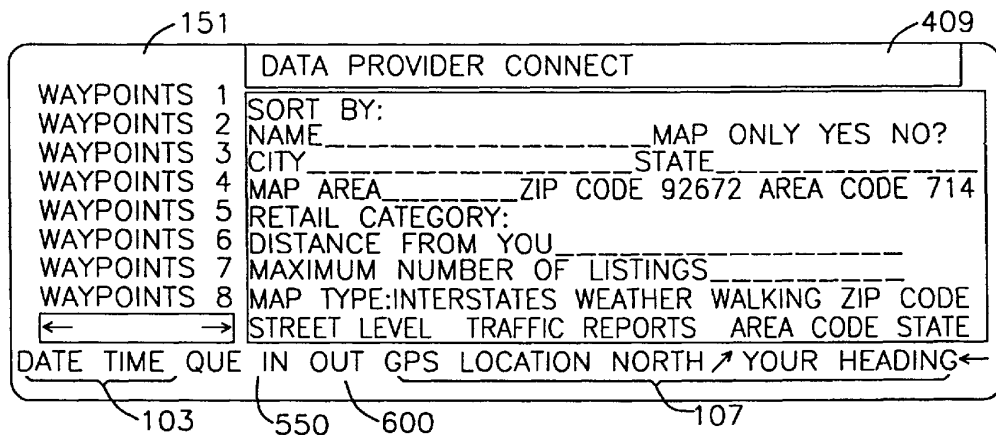

FIG. 16

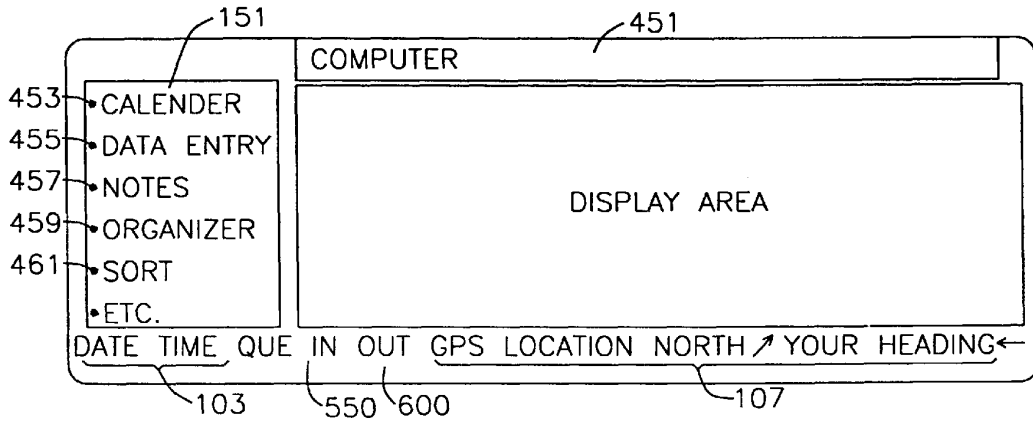

FIG. 17

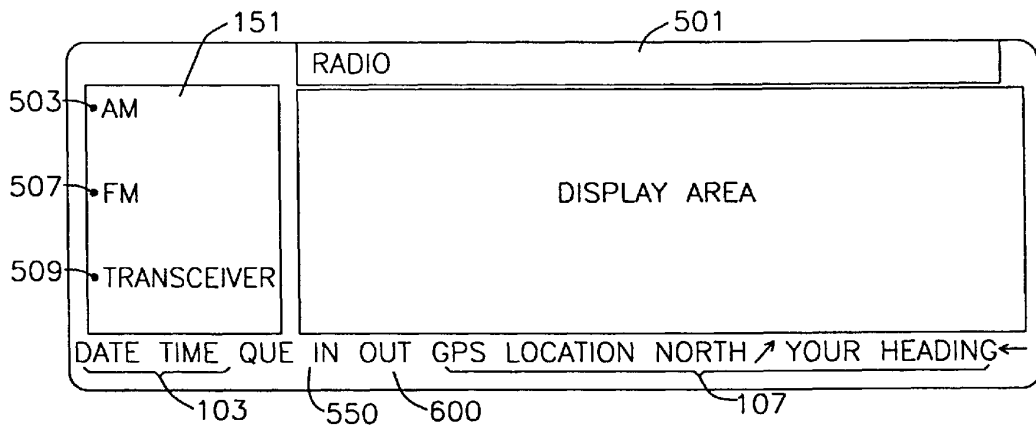

FIG. 18

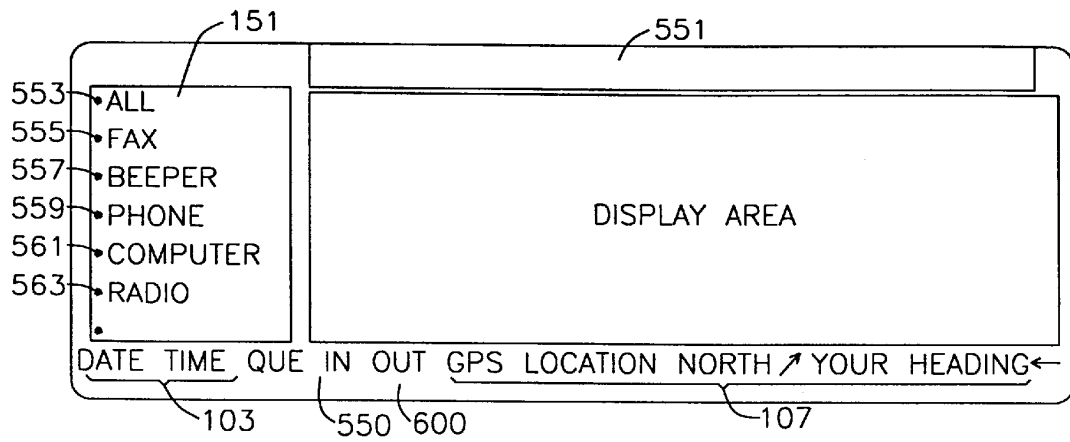

FIG. 19

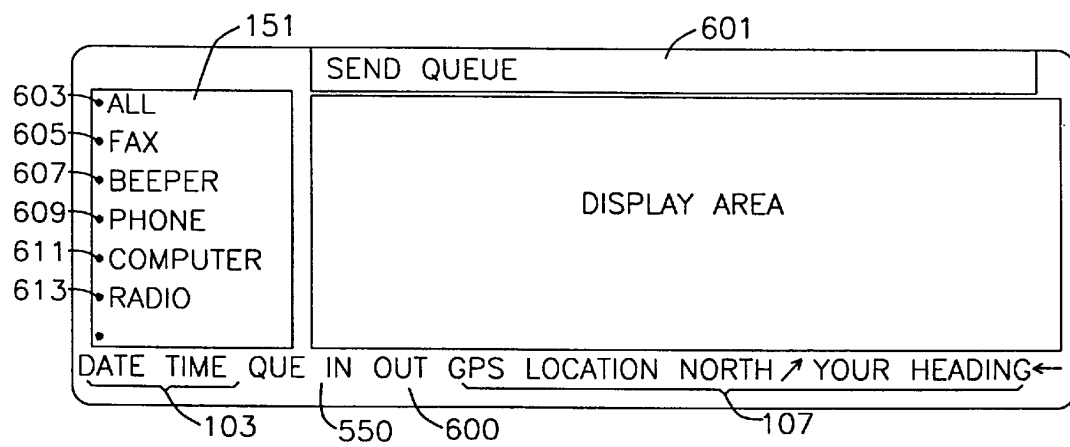

FIG. 20

LISTING / NAME / WAYPOINT	ADDRESS	CITY	STATE	PHONE NO	GPS LOCATION NORTH	GPS WEST	WAYPOINT
ALEX'S GERMAN-AMERICAN RESTAURANT	2801 S. EL CAMINO REAL	SAN CLEMENTE	CA	714-492-8986	33°24.60	117°36.25	1
ANTOINE'S CAFE	218 S. EL CAMINO REAL	SAN CLEMENTE	CA	714-492-1763	33°25.40	117°37.38	2
BAKERS'S SQUARE RESTAURANT & PIES	610 CAMINO DE LOS MARES	SAN CLEMENTE	CA	714-661-3100	33°27.80	117°39.60	3
BEACH GARDEN CAFE	618 1/2 AVENIDA VICTORIA	SAN CLEMENTE	CA	714-498-8145	33°25.35	117°37.36	4
BOOTLEGGERS GRILL & SPEAKEASY	111 AVE. PALIZADA	SAN CLEMENTE	CA	714-361-8658	33°25.65	117°37.85	5
BURBON STREET SANDWICHERY	430 N. EL CAMINO REAL	SAN CLEMENTE	CA	714-492-7827	33°25.58	117°37.76	6
BURGER STOP	524 AVENIDA PICO	SAN CLEMENTE	CA	714-492-2350	33°25.92	117°37.12	7
BURRITO BASKET, THE	2017 S. EL CAMINO REAL	SAN CLEMENTE	CA	714-498-5002	33°25.10	117°36.34	8
CAFE CALYPSO	114 AVENIDA DEL MAR	SAN CLEMENTE	CA	714-366-9346	33°25.42	117°37.42	9
CAFE EXPRESSO	641 CAMINO DE LOS MARES	SAN CLEMENTE	CA	714-240-3467	33°25.81	117°37.31	10
CAPTAN CULVER COUNTERCULTURE NATURAL FOODS	149 AVENIDA DEL MAR	SAN CLEMENTE	CA	714-498-8098	33°25.39	117°37.40	11
CARL'S JR. RESTAURANT	638 CAMINO DE LOS MARES	SAN CLEMENTE	CA	714-493-0189	33°27.65	117°39.45	12
CARL'S JR. RESTAURANT	3929 S. EL CAMINO REAL	SAN CLEMENTE	CA	714-498-5841	33°24.50	117°35.95	13
CARROWS RESTAURANT	620 AVENIDA PICO	SAN CLEMENTE	CA	714-492-4290	33°25.85	117°37.10	14
CHINA BEACH CANTEEN	2369 S. EL CAMINO REAL	SAN CLEMENTE	CA	714-492-6228	33°27.80	117°37.15	15
CHINA WELL RESTAURANT	620 CAMINO DE LOS MARES	SAN CLEMENTE	CA	714-661-6813	33°27.61	117°39.42	16
COCO'S FAMILY RESTAURANT	2350 S. EL CAMINO REAL	SAN CLEMENTE	CA	714-498-1542	33°24.90	117°36.18	17
CORKY'S CAFE	2727 VIA CASCADITA	SAN CLEMENTE	CA	714-492-1135	33°25.10	117°37.48	18
COURTSIDE RESTAURANT	111 AVE. VISTA MONTANA	SAN CLEMENTE	CA	714-361-2211	33°25.10	117°36.10	19
DAVE'S MEXICAN RESTAURANT	1701 N. EL CAMINO REAL	SAN CLEMENTE	CA	714-492-7867	33°25.50	117°38.90	20
DEL TACO	109 CALLE DE INDUSTRIAS	SAN CLEMENTE	CA	714-492-5311	33°25.51	117°36.50	21
DENNY'S RESTAURANT	529 AVENIDA PICO	SAN CLEMENTE	CA	714-492-2382	33°25.48	117°36.15	22
DOMINOES PIZZA	1502 N. EL CAMINO REAL	SAN CLEMENTE	CA	714-498-9002	33°25.25	117°37.50	23
EASTERN WINDS	201 N. EL CAMINO REAL	SAN CLEMENTE	CA	714-492-3008	33°25.01	117°37.05	24
EL CAMINO TACOS	420 S. EL CAMINO REAL	SAN CLEMENTE	CA	714-366-8358	33°25.10	117°37.25	25
EL JEFF CAFE	106 E. ESCALONES	SAN CLEMENTE	CA	714-492-4010	33°25.25	117°37.03	26
EL MIRADOR	301 N. EL CAMINO REAL	SAN CLEMENTE	CA	714-366-0855	33°25.08	117°37.10	27

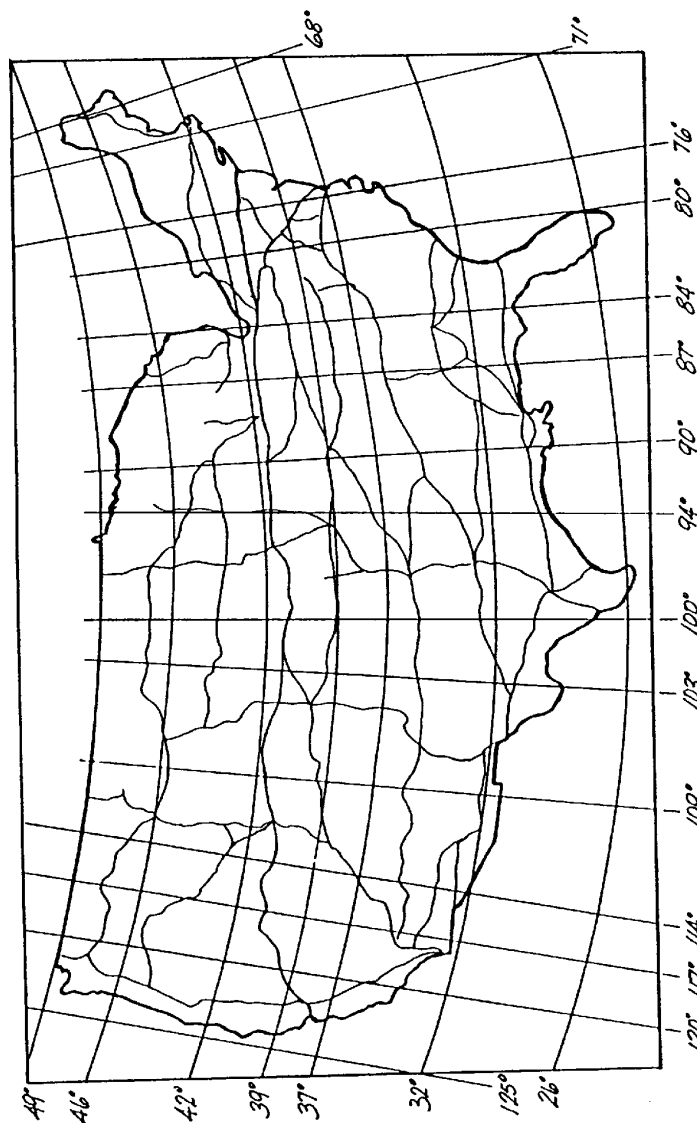

Fig. 21

- 115 LONGITUDE AND LATITUDE COORDINATES.
 - AREA CODE BOUNDARIES.
 - ZIP CODE BOUNDARIES.
 - NATIONAL PARK BOUNDARIES.
 - METRO TRAFFIC ZONES.
 - INTERSTATE BOUNDARIES.
 - US HIGHWAY BOUNDARIES.
 - STATE ROUTE BOUNDARIES.
 - CITY COUNTY STATE PROVINCE BOUNDARIES.
 - POLITICAL BOUNDARIES.
 - ECONOMIC, RETAIL, BUSINESS ZONE BOUNDARIES.
- GPS ENCODED EMBODIMENTS ARE NOT LIMITED TO THE ABOVE EXAMPLES AND MAY INCLUDE MANY OTHER SYSTEMS USING VARIOUS RECORDING TECHNIQUES

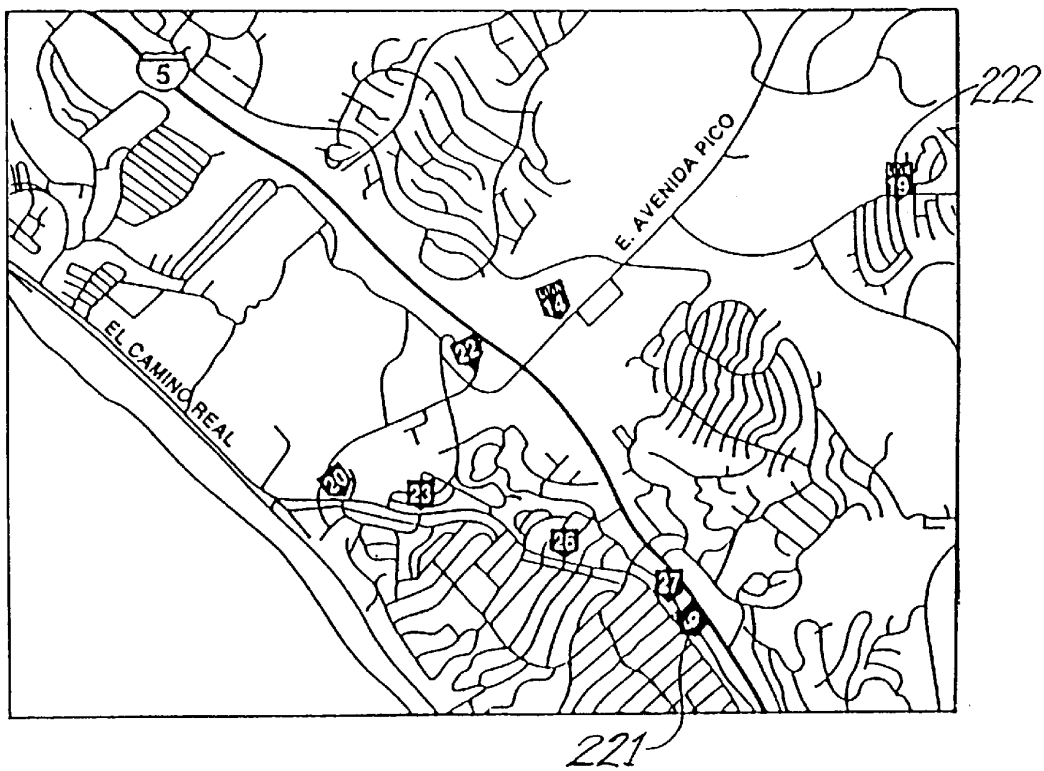

Fig. 22

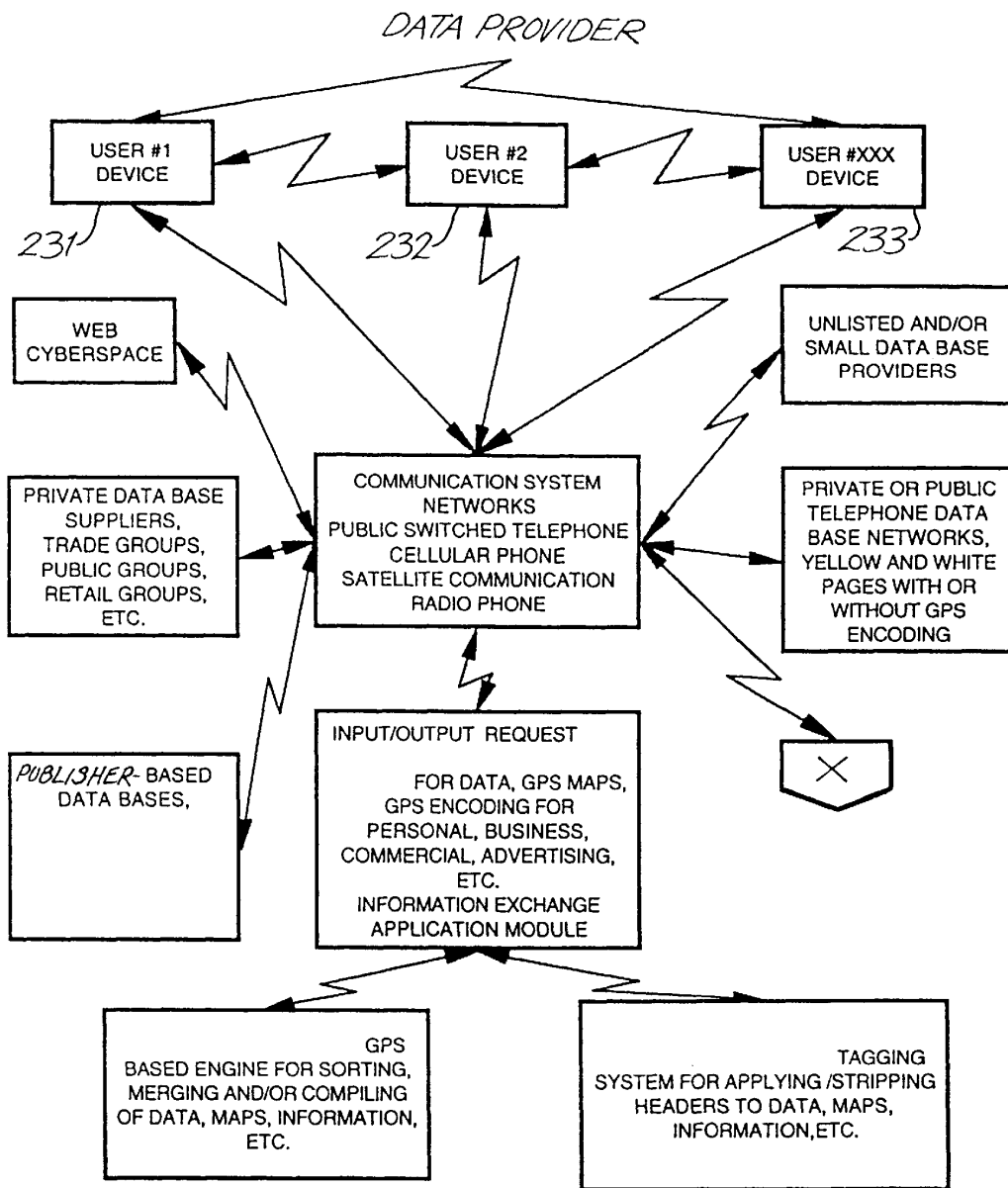

Fig. 23A

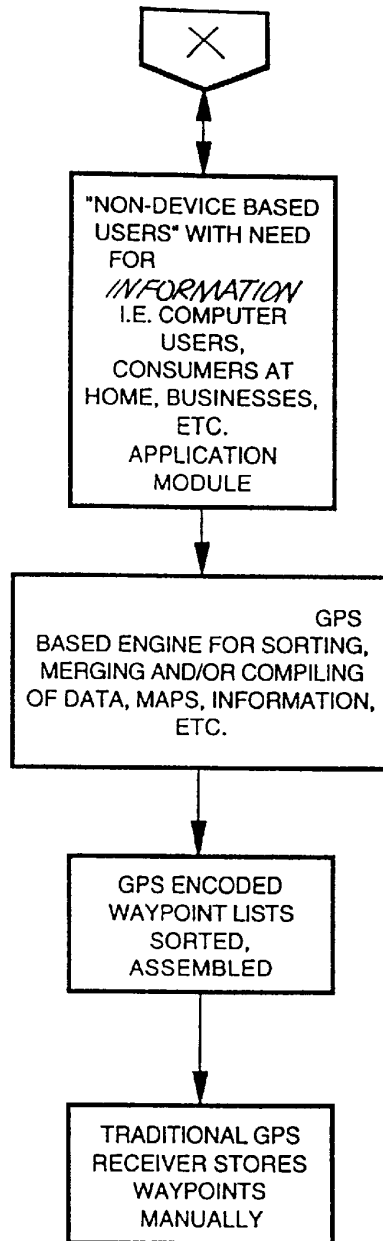

Fig. 23B

REQUESTER

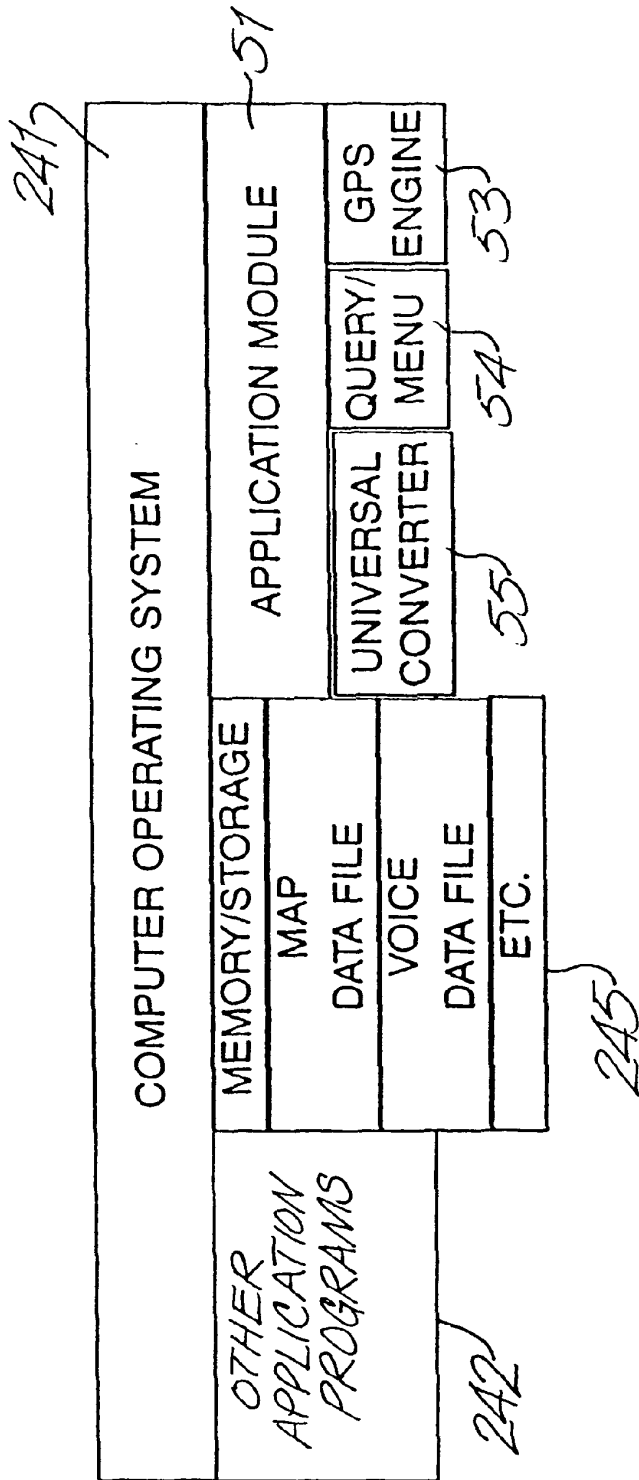

Fig. 24

PROVIDER

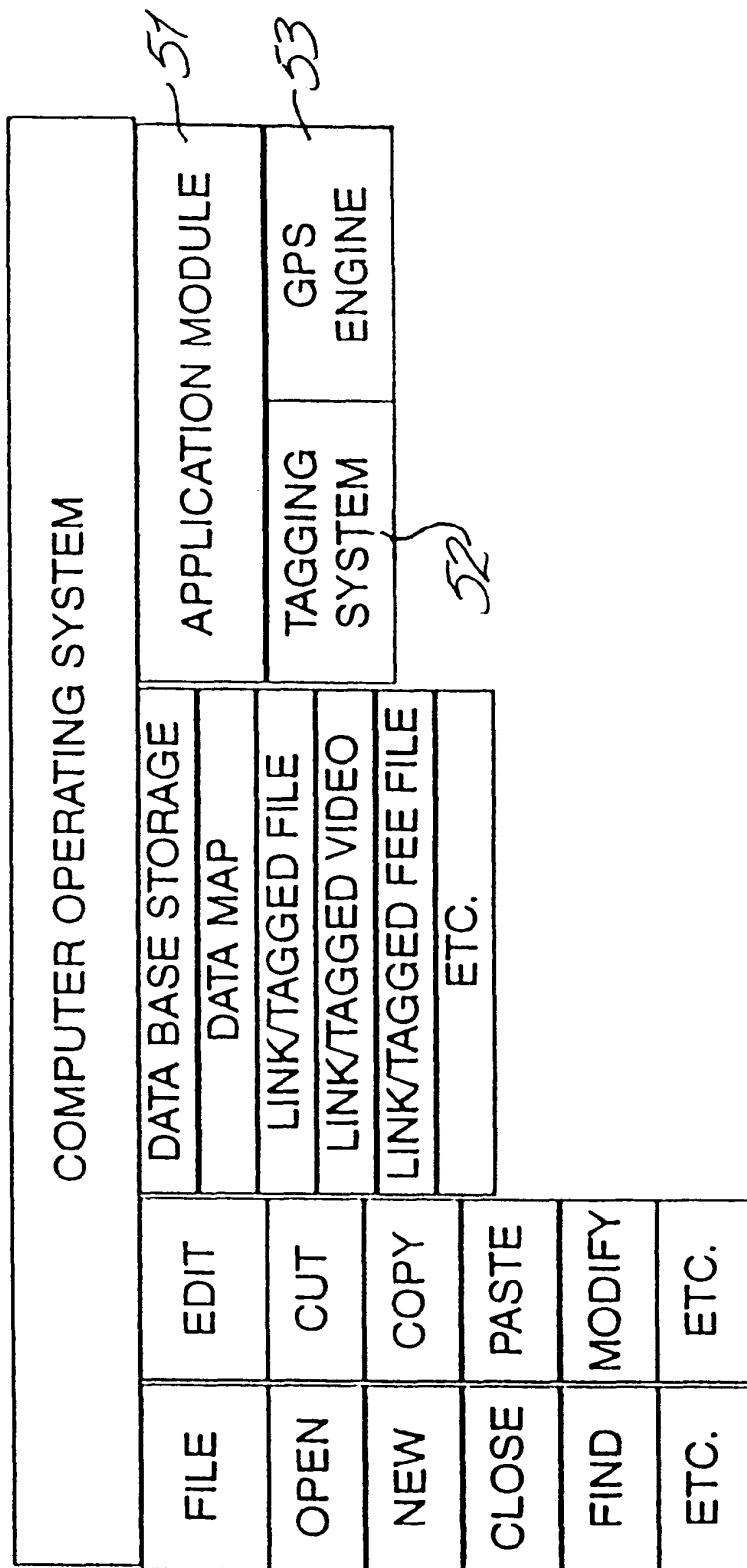

Fig. 25

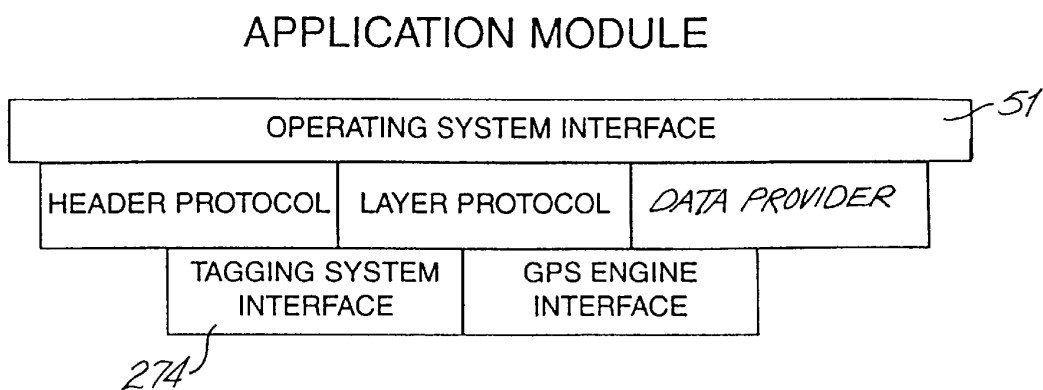

Fig. 26

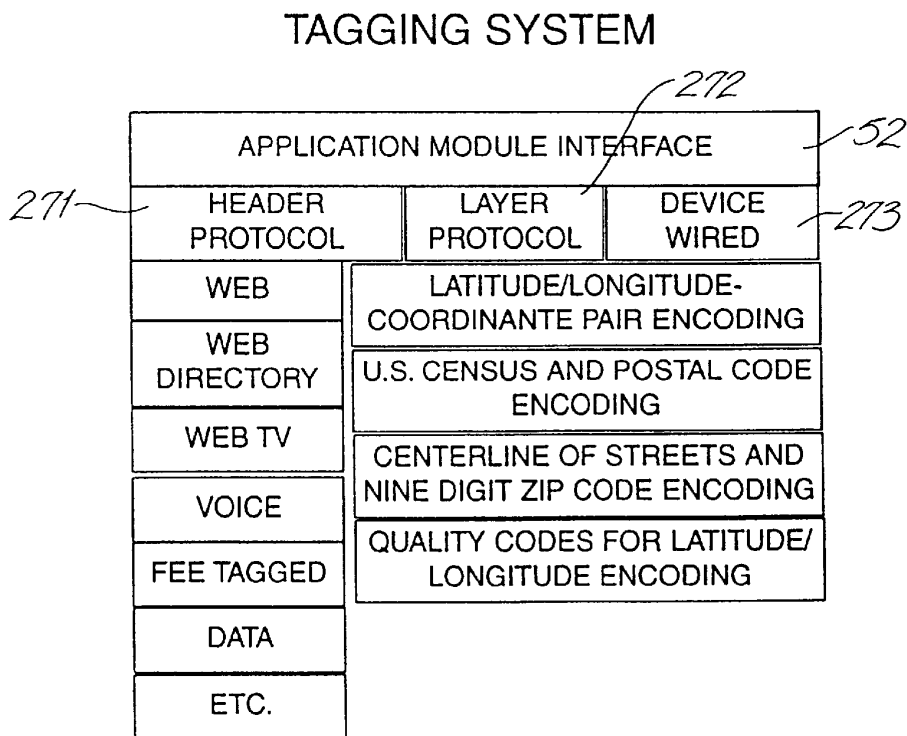

Fig. 27

GPS ENGINE

53

APPLICATION MODULE INTERFACE	
HEADER PROTOCOL	LAYER SYSTEM
TAG TYPE	LAYER PROTOCOL
LATITUDE/ LONGITUDE	ROUTE PLANNING
RADIUS	ACCESS LATITUDE/LONGITUDE QUALITY CODES FOR BEST DISPLAY SCALES
MAP	USE SPATIAL QUERY FUNCTIONS
WAYPOINT LINKS	USE CENTROID INTERPOLATION FUNCTIONS
ETC.	USE MATCH-RATE COMPARISON FUNCTIONS

Fig. 28

UNIVERSAL TRANSLATOR

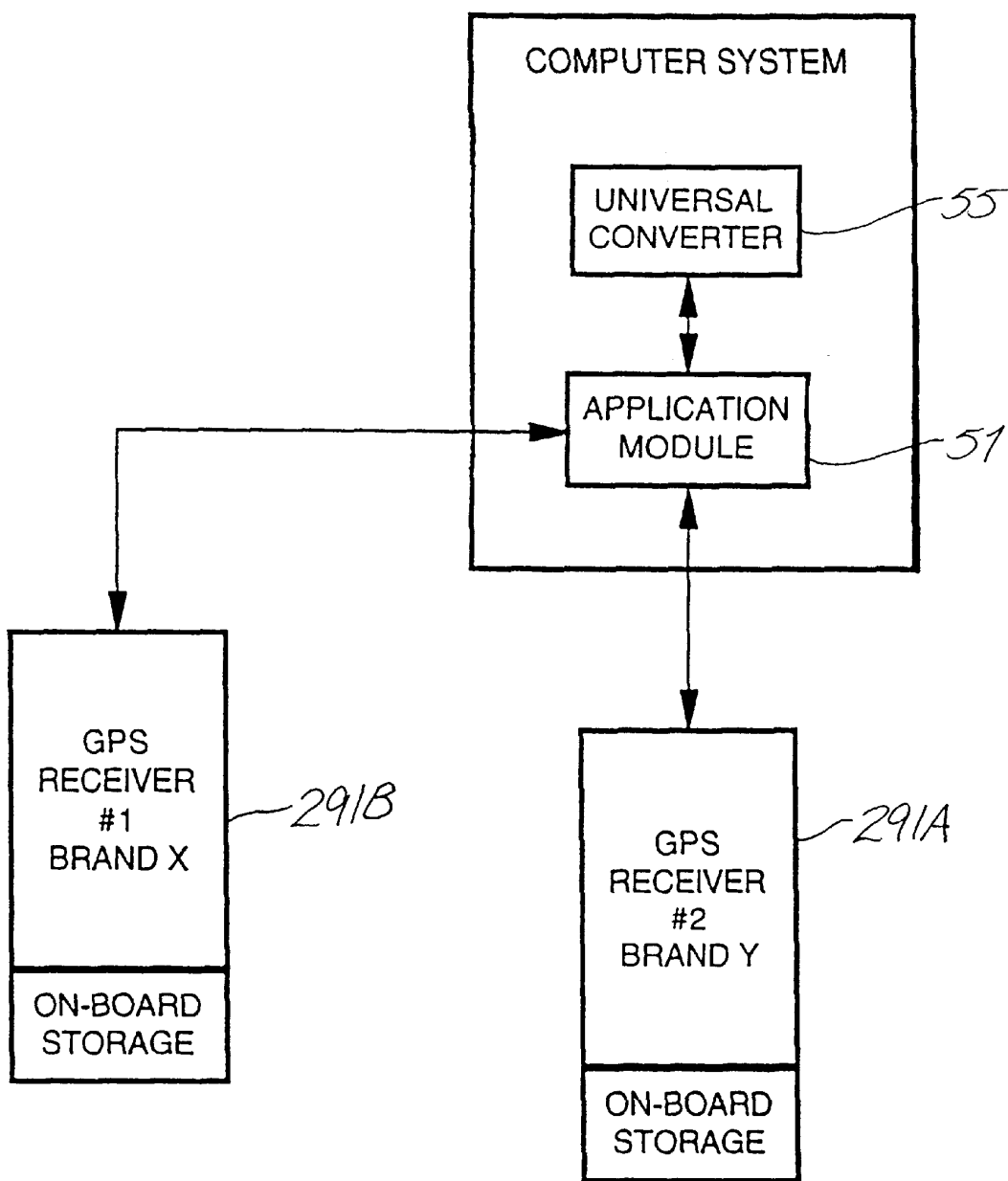

Fig. 29

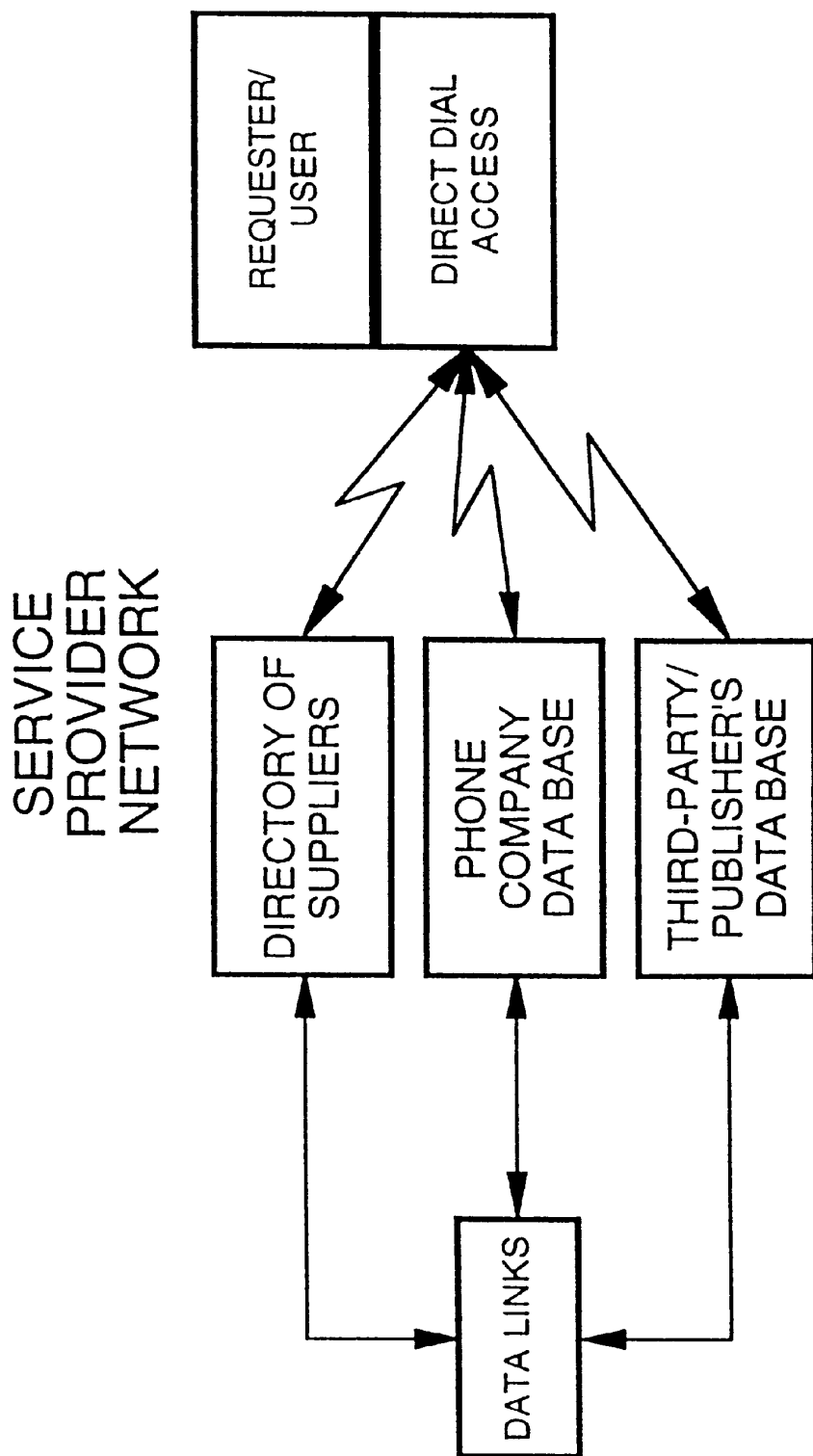

Fig. 30

DIGITAL WEB TV

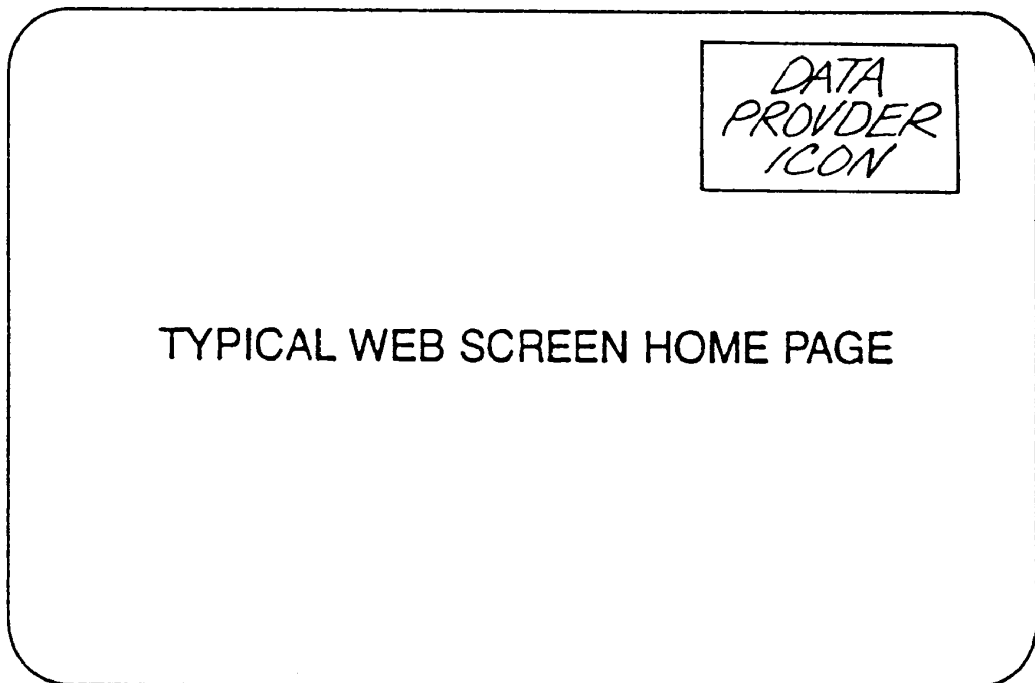

Fig. 31

US SATELLITE
 RADAR CURRENT
 DELTA RADAR
 LOCAL RADAR
 SURFACE MAPS
 WIND CHILL
 CURRENT TEMPS.
 JET STREAM
 TRAVEL HAZARDS
 FORECASTS
 SURFACE WINDS
 FARM
 SHORT RANGE

WEATHER MAP PROVIDER (PRESS TO UPDATE)

CENTER MAP BY:
 CITY _____ STATE _____
 LAYER MAPS _____ ZIP CODE _____
 AREA CODE _____
 DISTANCE FROM YOU _____ MILES/KILOMETERS
 DISTANCE FROM _____ MILES

MAP TYPE:
 (PRESS TO SELECT FROM LIST)
 UPDATE MAP LIST @ _____ HOUR
 UPDATE EVERY _____ HOUR, PROMPT Y/N ?
 ANIMATE MAPS Y/N PLAY NAVIGATE MAP Y/N

DATE TIME QUE IN → OUT ← GPS LOCATION NORTH ↗ YOUR HEADING ←

3:21A-M

107

FIGURE 32

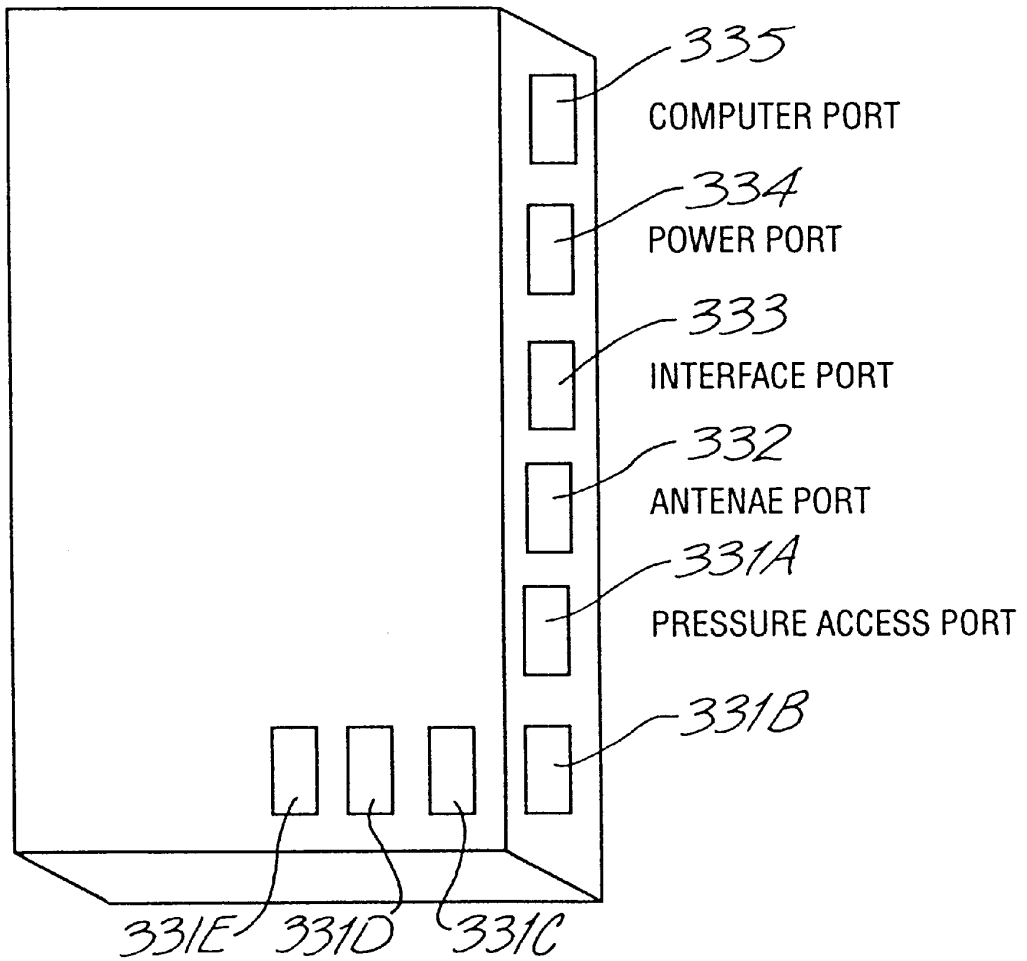

FIGURE 33

**PERSONAL COMMUNICATION SYSTEM
FOR COMMUNICATING VOICE DATA
POSITIONING INFORMATION**

**CROSS-REFERENCE TO RELATED
APPLICATIONS**

This patent application is a divisional application of U.S. patent application Ser. No. 08/879,955, filed on Jun. 20, 1997 now U.S. Pat. No. 6,148,261 the disclosure of which is incorporated by reference.

FIELD OF THE INVENTION

The invention relates generally to a system for communicating data including global-positioning-encoded information. In particular, the present invention relates specifically to a device and system for communicating and retrieving position and position related data.

BACKGROUND OF THE INVENTION

Availability of up-to-date information is more important today than ever before and this will continue to be true for the foreseeable future. People want to be well informed, so much so that they travel with cellular phones, beepers, and even portable hand-held Global Positioning System (GPS) satellite receivers.

GPS capable devices generally have a GPS receiver for receiving satellite signals from the GPS satellite network that allow for determination of the device's position. Such devices allow for precisely locating the device in terms of latitude and longitude using the GPS receiver. Some devices have map data stored in memory and a display for showing the device position with reference to the map data. Other devices have no underlying map data base for reference. Rather, they show only the geographic coordinates of the device's location. These coordinates may be referred to as waypoints. Most GPS receiver devices can store many waypoints. Some GPS receiver devices can plot and display a trail of waypoints and store this trail for future retrieval. Sophisticated devices may compute the device's heading, speed, and other information based on comparisons with previous GPS determined positions.

GPS receiver devices with map display capability may store the map information on computer diskettes, CD-ROMs, or other computer memory storage devices. The device location may then be displayed on a display terminal with reference to a map stored in the computer memory storage device. The available quantity of map data, however, can overwhelm the memory capability of easily portable computer devices. This problem is exacerbated when additional information is included and linked with the map data. In addition, information is more valuable when it is up to date and available at the time of consumption, and such devices do not incorporate a means for updating the stored information. By way of example, a CD ROM could never maintain an up-to-date list of every 5-star restaurant.

Some GPS receiver devices have the ability to communicate over a telecommunications network. These devices do not provide for automatic or semi-automatic dynamic exchange of on-line position dependent or related information. In addition, these devices cannot communicate with third parties in the absence of a uniform data format standard. For example, a cellular-phone-based system comprising GPS location information working in conjunction with proprietary Public Safety Answering Point (PSAP) telephone equipment is known. The device provides personal

and medical information on an emergency basis to the proper authorities. Such a device does not allow third parties to communicate, tag, interrogate, limit, designate, modify or share this information amongst themselves for any other use.

To that end, the ability to receive digital data structures with GPS encoding, and storing this information for eventual use or broadcast to third parties, would be valuable. Today, the U.S. and several other countries have independent publishers busily GPS mapping everything down to the most minute detail. Most of these data bases are available on CD ROM storage. The problem is that no one data base can contain enough information to fulfill the unique requests of every particular and picky consumer. The costs associated with providing and maintaining such a large data base would be overwhelming and over-burdening. Additionally, most consumers do not like reading or compiling vast data bases.

SUMMARY OF THE INVENTION

The system of the present invention comprises Personal Communications Devices (PCDs), and traditional computer systems with GPS engines, routers, and other application programs to request, process, and transmit tagged GPS encoded information. The system, with related applications, can be accessed by device users, traditional computer users, web-site users (cyberspace), data publishers, public or private enterprises or individuals, by means of application programs. The tagged GPS encoded data files can be stored or sent via communication links using AM, FM, spread spectrum, microwave, laser or light beam in free or fiber optic, line-of-sight, reflected, satellite, secure or non-secure, or any type of communications between multiple points that the application or the state-of-the-art may allow. The system is a waypoint tag and interrogation system using various protocols to answer requests and provide GPS-encoded information. The applications use GPS devices, engines, routing and encoding for access to specific requester-designated data retrieval requests. The applications access fax machines, beepers, telephones and other communication linked devices. The system accesses computer and storage systems with various applications in order to provide this information from a plurality of providers. The system thereby eliminates or reduces the need for large storage devices and interchangeable storage modules.

One embodiment of the present invention includes a requesting device, a data provider (hardware and software), a user, tagger applications or GPS engine and router system with protocols for encoding, tagging, modifying, interrogating, arranging, limiting, displaying, sorting, mapping, segregating, sending, receiving and updating waypoint and the waypoints connected data structures with digital or graphic maps, digital voice files, linked digital web files properly encoded and tagged by way of specific devices, or by traditional computer and storage systems.

The application programs contain protocols for users, providers, taggers, list maintenance organizations, and others, and will use a dynamic identification system from applications containing GPS search engines, route planners, compilers, designators, publishers, and others is to permit communication of information.

The PCD is a cellular-phone-sized electronic device, combining the capabilities of a GPS receiver, transceiver, digital beeper, cell phone and projection system into one compact unit. The PCD is capable of uploading emergency information (medical, police alert, etc.) via a one-push button that phones 911 or a security monitoring center similar to those used for house alarms. The alert continues to be broadcast until a response is made.

3

The PCD is also capable of downloading information via a request to a data provider, similar to a request for directory information from a phone company or other service. In this mode the PCD acts similar to calling a phone operator for information. However, in this instance, no human contact is required. The caller requests specific information (location of gas stations, names of restaurants, local banks, etc.) via a voice command ("Download e.g., Wells Fargo Banks") or via digital commands using a keypad or other input device and the requested information is automatically downloaded to and stored in the memory of the user's PCD. This information can be accessed off-line via the screen on the PCD. It is all done digitally, eliminating having to write down information such as name, address, location map, GPS latitude and longitude encoding, direction and distance to location, hours of operation, or other items of information. The PCD can be plugged into an automobile input port or similar device, if available, and provide distances and directions to locations of interest. Similar information of a condensed nature can also be provided to the user via the screen of the PCD. The user is not required to be a subscriber to some proprietary system, instead the PCD can use any means to access any data base from any potential provider, whether GPS encoded or not.

In some areas the information would be sent and received by way of a Local Area Broadcast via radio frequency signals to each home, car or PCD within a reception area. In such an embodiment, users are able to access companies listed on the broadcast network from data providers of properly tagged, yellow page-type information or are provided with GPS encoded information and maps similar to web page listings. This would be advantageous to small towns with little information available for travelers, but which have an interest in providing up-to-date traffic, weather and travel advisories to benefit the local community and businesses. Such a system does not require a master, home or base unit. The providers of data base or advertising information could be a single data provider and could also be individual users with application programs that allow provision of such data. The application programs provide a means for sending and receiving data, GPS encoded data and graphics encoded data. The application programs can also act as a universal coder/decoder to other proprietary GPS data bases.

The present invention allows users to request detailed information relating to their present location as well as information related to distant locales. Some of the advantages provided by the invention include:

1. Information can be received digitally by a PCD user from any system.
2. Multiple requests can be retained, stored or resent.
3. In-depth dynamic data retrievals are possible and could be viewed later.
4. GPS tagging and encoding with latitude and longitude information along with encoded maps for navigation.
5. Small non-contiguous map segments are possible.
6. On-line storage of data personal and other information, along with GPS encoded maps on some data files.
7. Display menus, interfaces and applications can be viewed on heads-up display systems in automobiles, homes, businesses and various commercial applications.
8. Allows for portable Internet access.
9. Provides a means for an Internet based telephone directory access tagged and linked to the originating area code and phone numbers.

4

Remote and distant third parties could communicate with each other and, by sending and receiving GPS encoded data, can meet or find each other in remote locations. Maps and other digital data may be transmitted/received by fax, beeper (receive only), computer, phone and radio.

One embodiment of this invention would include a system of non-subscribers communicating to each other in a similar fashion, without the use of base stations. In addition, the non-subscribers could send personal data bases with maps included, GPS information, and other information of non-related data or graphics from publishers of any such data base. In this embodiment the device would act as a transceiver, sending and receiving dynamic moving waypoint information in digital formats, including maps of various sizes and embodiments.

The PCD can display a singular or a plurality of images and displays, project an image on to a screen or viewing surface, store or communicate data (depicted as a line, graphic, icon, etc.) to and/or receive latitude and longitude data from third parties. Additionally, the device can send/receive latitude- and longitude-encoded maps and other data to/from a third party, send/receive standard or non-standard phone and fax communications (AM, FM, spread spectrum, microwave, laser or light beam in free or fiber optic, line of sight, reflected, satellite, secure or non-secure, or any type of communications between two points that the application or state-of-the-art may allow), perform computer functions from existing application software and operating systems, receive standard or non-standard beeper messages, interface with a conventional computer and provide an interface to a heads-up display, an external viewing device or any projection system.

An embodiment of this invention incorporates a GPS transceiver with a designated application used with a communication system or network. Several users of this invention can communicate and send data, maps and graphic files with or without GPS encoding. By example, a user could request from another party a map of walking trails of Yosemite Valley with latitude and longitude designations properly GPS encoded. This map may not be in the requesting user's data base or in a large number of subscriber's or non-subscriber's data bases. This highly stylized map and encoded information, of a possible non-uniform nature, could be on just one user's PCD device or external source. The requesting user could contact the specialized source for specific information, and be sent via a communication link, the specific data, this data could then be modified by the user and sent back to the original provider.

The preferred embodiment of the PCD and system provides a means for requesting and receiving data files which can be tagged, modified and interrogated. This data can be comprised of many different formats and applications with potentially unique compilations from potentially unrelated, (non)-subscribers or (non)-linked users. These users can communicate with commercial, business and personal computer systems and devices having the capability of running an application (or applications) and having the ability to request and provide waypoint information which can be tagged, modified and interrogated.

Another preferred embodiment of this invention provides a means for decoding tagged, modifiable and interrogatable maps and data files furnished by third parties for display on the user's PCD or traditional computer devices.

In one embodiment of the device and tagging system the GPS information is communicated from locations, homes, businesses, commercial designations, government resources, public and private areas, cyberspace and other

5

communication systems. Various designated locations, or a plurality and multiplicity of locations, or data structures, are assigned as waypoints. These waypoints could be tagged, or interrogated from an application program which describes, encodes, reports, modifies and communicates this encoded information and data from any location. In addition, the transmitting device may report a plurality and multiplicity of locations or events unrelated to either the location of either the transmitting or receiving device. Indeed, the device could communicate to many unlinked, unreported or unconnected waypoints and send active dynamic information to the requester. Cyberspace providers may enter the network web system, use applications for device communications and participate in the exchange of information using designated GPS engines and applications. By way of example, the invention can provide a requester with dynamic advertisements encoded with maps, location information, or other data to a location anywhere in the U.S. Indeed, tagged files which are linked can be sent from a third-party publisher located in another state.

The system is similar to the world wide web, except the web does not use GPS engines, applications, tagging systems, etc. By way of example, one difference is that the invention uses GPS devices, engines, applications and encoding for access to specific requester designated data retrieval techniques. The invention provides a means to locate specific individuals or places using standard GPS search techniques.

The system includes the concept of storing data, including voice messages. The system encodes files for use in a location tagged data format system. Users can request and compile information and store the information on remote computer systems. Certain protocols for compilation, encoding and tagging data files may be desirable in order to create files for system usage.

An embodiment of the invention uses fax, beepers, telephones, and/or computer and storage systems with application programs to properly GPS encode, tag, modify and interrogate requests and provide same from a plurality of providers. An embodiment of the invention includes applications or GPS engine systems for encoding, tagging, modifying, interrogating, arranging, limiting, displaying, sorting, mapping, segregating, sending, receiving and updating waypoints and its connected data structures with maps, or by any other means by way of specific devices, or by traditional computer and storage systems.

Another advantage the invention provides is a means to display this type of information and a means to store data unrelated to any interrogation by the PCD device. Methods of display include multiple of displays including, by example, overhead displays, heads-up displays, projection systems, LCD displays, computer displays or any past or future designed displays whether connected directly or by some electromagnetic means. The preferred embodiment of the device could include any means of display or combinations thereof. In addition, the device could include many control devices such as remote control, remote mouse type devices and any combination of keyboards.

Further objects, features and advantages of the invention will become apparent from the following detailed description taken in conjunction with the accompanying drawings showing an illustrative embodiment of the invention in which like parts are designated by like reference numerals throughout.

DESCRIPTION OF THE DRAWINGS

FIG. 1 illustrates a GPS transceiver system and communication links incorporating the present invention;

6

FIG. 2 is a front perspective view of a PCD of the present invention showing a layout of controls and an initialization screen;

FIG. 3 is a rear view of the PCD of FIG. 2;

FIG. 4 is a block diagram of the PCD of FIG. 2;

FIG. 4A shows a screen menu hierarchy of the PCD of FIG. 2;

FIG. 5A illustrates a flow chart depicting the program sequence for the entry of a personal identification number (PIN) and personal data into the PCD of FIG. 2

FIG. 5B illustrates a flow chart depicting the program sequence for the user to select a mode of operation using the PCD of FIG. 2;

FIG. 5C illustrates a flow chart depicting the program sequence for the user to control the GPS mode of the PCD of FIG. 2;

FIG. 5D illustrates a flow chart depicting the program sequence for the user to control the phone mode of the PCD of FIG. 2;

FIG. 5E illustrates a flow chart depicting the program sequence for the user to control the computer mode of the PCD of FIG. 2;

FIG. 5F illustrates a flow chart depicting the program sequence for the user to control the radio mode of the PCD of FIG. 2;

FIG. 6 illustrates the Main Menu page of the PCD of FIG. 2;

FIG. 7 illustrates the select GPS Function page of the PCD of FIG. 2;

FIG. 8 illustrates the GPS: Location page of the PCD of FIG. 2;

FIG. 9 illustrates the GPS: Show Me page of the PCD of FIG. 2;

FIG. 10 illustrates the GPS: Get Map page of the PCD of FIG. 2;

FIG. 11 illustrates the GPS: Third Party page of the PCD of FIG. 2;

FIG. 12 illustrates the FAX page of the PCD of FIG. 2;

FIG. 13 illustrates the Beeper page of the PCD of FIG. 2;

FIG. 14 illustrates the Phone page of the PCD of FIG. 2;

FIG. 15 illustrates an Information Request page of the PCD of FIG. 2;

FIG. 16 illustrates the Computer page of the PCD of FIG. 2;

FIG. 17 illustrates the Radio page of the PCD of FIG. 2;

FIG. 18 illustrates the Receive Queue page of the PCD of FIG. 2;

FIG. 19 illustrates the Send Queue page of the PCD of FIG. 2;

FIG. 20 illustrates a typical listing downloaded from a data provider;

FIG. 21 illustrates a typical GPS encoded map downloaded from a data provider;

FIG. 22 illustrates atypical GPS encoded map with waypoints locating restaurants within a specified radius;

FIG. 23A illustrates an exemplary data provider;

FIG. 23B illustrates an exemplary configuration of a non-PCD computer utilizing a modified application module;

FIG. 24 illustrates a software module configuration of a requester;

FIG. 25 illustrates a software module configuration of a provider;

FIG. 26 illustrates a software module configuration of the application module;

FIG. 27 illustrates a software module configuration of the tagging system;

FIG. 28 illustrates a software module configuration of the

FIG. 29 illustrates a software module configuration of the universal translator;

FIG. 30 illustrates a typical configuration of the service provider;

FIG. 31 illustrates a possible configuration of the digital web TV;

FIG. 32 illustrates the Weather Map Request page of the PCD of FIG. 2; and

FIG. 33 illustrates a weather reporting device.

DETAILED DESCRIPTION OF THE INVENTION

FIG. 1 shows a system capable of communicating using the electromagnetic energy spectrum, traditional computer networks, cellular phone networks, public telephone networks, and satellite system networks. The major components of the system comprises personal communication devices (PCDs) 20 and one or more of the following: a cellular phone network 60, a standard phone line network 70, an electromagnetic energy spectrum network 80 and/or a computer network 90. The PCD receives signals from a GPS satellite system 10.

FIG. 2 illustrates a PCD of the present invention. The PCD has a display 28a. The display may be of a LCD type or other types known in the art. Incorporated with the display is a touch screen input device 28b, which are known in the art. The PCD also has an alphanumeric key pad 26, which includes many of the standard keys generally found on computer keyboards. The location of the keys, and the selection of the characters used on a single key, may be varied as desired. The PCD also has specialized keys 27a-g, n related to GPS, telecommunications, and other functions. Located on one side of the PCD are a number of input and output ports. In the embodiment shown, these ports include a modem output port 29g, a generalized communication port 29f, a power port 35b, an infrared port 29e, and a heads-up display interface port 25k. The location of these ports are shown for descriptive purposes only, the specific location of these ports on the PCD is not critical. The power port allows the PCD to be operated from an external power source (not shown). The communication port allows the PCD to be connected to printers, local computer networks, and the like.

FIG. 3 shows a rear view of the PCD of FIG. 2. The rear of the PCD contains a microphone 34 towards one edge of the rear of the PCD and a speaker 33 towards the opposing edge. The layout of the microphone and the speaker is similar to that found in portable cellular telephones. An antenna 32 extends from the edge near the speaker to allow for communication in a cellular telephone network or via other electromagnetic spectrum means. The PCD contains a battery 32a. The battery allows for mobile operation of the PCD and is the selected power source if an external power source is not available through the power port. The PCD's operation is governed by a processor 21. A variety of microprocessors may be used, with the selection of such determined by processing power, power utilization, and other factors and requirements. The PCD has a slot 23 for a PCMCIA card, CD-ROM, or other computer accessory. The PCD is powered on when the power button 31 (shown in

FIG. 2) is depressed. In the embodiment shown, at initial device power on, the processor causes the PCD to display the initialization screen 100 (shown in FIG. 2).

FIG. 4 shows a block diagram of the PCD. Control and logic functions are performed by the processor 21. Internal data storage 22, which is provided by conventional memory such as RAM or ROM or variations thereof, may be accessed by the processor. The processor may also access removable data storage devices 23 such as a hard disk installed via the PCMCIA slot, a CD-ROM type device or other similar removable data storage devices. The processor is connected by a data bus 24 to a number of devices. These include the alphanumeric key pad and other special purpose keys, the touch screen, and other hard wired input devices. The heads-up display output port and the display screen are also connected via the data bus to the processor, it being recognized that a number of display related devices such as VGA cards, chips, and the like are also required to implement the display device functions and the other previously mentioned functions. The microprocessor may also access or control communications with telephone networks, either hardwired or cellular, radio transmissions, infra-red transmissions, or communications with other computer devices.

All known verbal commands from GPS systems can be implemented and attachment or inclusion of voice activation for map instructions relative to location, GPS and street designations, including heading descriptions, distance, and arrival time estimates can be included.

FIG. 24 illustrates a block diagram of the PCD's software components. An application module or program 51 interfaces with the PCD's operating system 241. The operating system may be DOS, UNIX, Windows 95, Windows NT, O/S2 Apple McIntosh, Next Computer, or other operating systems, including operating systems well suited to devices with constrained memory or other limitations due to the small physical size of the PCD. The operating system additionally interfaces with other application programs 242 that provide standard file edit and other functions typically found in personal computers. The operating system, or other application programs interfacing with the operating system, provide for maintenance of data bases 245 used by the PCD. The application module includes a GPS engine 53 providing GPS functions, including interfacing with the GPS receiver 243 (shown in FIG. 4). A query menu program 54 of the application module controls the graphical user interface and related functions for the device. Included in the application module is a universal converter 55.

As illustrated in FIG. 29, the universal converter enables the PCD to read in data provided by third parties 291a, b and convert or filter such data to a format useable by the PCD. The universal converter first inspects the received data to determine if the data is in a known format which can be converted to the format used by the PCD. If the format is not known by the device, the universal converter attempts to extract any ASCII data or format the data as a bit map as appropriate.

As illustrated in FIG. 26, the application module further includes programs to implement data formatting and communication protocols using header protocols 271, layer protocols 272, and data provider protocols 273. The application module also includes a tagging system interface program 274. The elements of the tagging system are illustrated in FIG. 27. The purpose of the tagging system is to provide a common universal data structure for requests and responding to requests. Various techniques common in

the GEO coding industry, using U.S. Census bureau data and tiger files with certain modifications, can establish parameters for software suppliers to use latitude and longitude encoding as coordinate pairs, postal code encoding and street centering encoding, all for the benefit of accuracy in designating certain files as "tagged". The tagging system provides the ability to apply and strip header and layer information to and from data files.

FIG. 4A shows the top level page menu display hierarchy of the PCD. At initial power on the initialization page 25a (shown in FIG. 2) is displayed. The initialization page allows for the entry of a personal identification number and other data. Depressing the home button 27E (shown in FIG. 2) displays the Main Menu page 25b. A number of additional pages are available from the Main Menu page. These include the GPS 25c, Fax 25d, Beeper 25e, Phone 25f, Computer 25g, Radio 25h, Send Queue 25i, and Receive Queue 25j pages.

FIG. 5A lists a sequence for the operator of the PCD to answer certain questions, provide information for future access regarding handling of emergency events and handling of same by civil authorities or private individuals empowered to act on behalf of the operator. Access is denied or provided based upon user codes. The entry of a user code may allow for limited to full access of the data stored in the device and usage of same with different codes providing different levels of access and usage. Similar information and sequencing is provided by the application modules and operating system for medical and other information in the event of emergencies. In one embodiment of the preferences screen (not shown) information can be displayed in a specified manner, events recorded and equipment options listed. Specific usage of the device and furnished software would be recalled by each user having access and user codes to operate the PCD, each user having unique individual screens and setups based on that user's preferences. The initial setup of screen preferences and other user configuration details are well known in the art.

Selecting PIN 111 from the Main Menu page displays a screen 113 prompting the user to input a personal identification number. Using an alphanumeric key pad 26, the user inputs a personal identification number and presses ENTER 27g. The processor analyzes the entered personal identification number and determines if the number is valid 115 FIG. If the entered personal identification number is valid the processor enables PERSONAL 121, MEDICAL 131, PREFERENCES 141 touch points on the display screen. These touchpoints, and touchpoints later referred to, are selectable either by pressing the display screen at the touchpoint location or by selecting the underlying display item with the cursor. If the PCD already contains personal, medical and preference data, the HOME button 27e is enabled. If the personal identification number is not valid, the processor 21 will increase the device security level 119. This may include, but is not limited to, disabling the PCD operation for a specified time. Selecting PERSONAL 121, MEDICAL 131 or PREFERENCES 141 touchpoints displays the corresponding pages 123, 133, or 143. These pages request specific data, and allow the user to input data using alphanumeric key pad 26. Completion of data entry is indicated by pressing the ENTER button 27g.

In addition, the Initialization page 100 FIG. 2, as well as all other pages, displays the time and the date 103, touch points for QUE IN 550 and OUT 600 (described later in this document) and limited GPS information 107. The limited GPS information comprises of the user's location (latitude and longitude), an arrow pointing to north and an arrow indicating direction of device travel.

When enabled, pressing the HOME button 27e (FIG. 2) signals the processor to display the Main Menu page 150 FIG. 5B. As shown in FIG. 6, the Main Menu page allows the operator to use the touch screen to select the GPS 200, FAX 300, BEEPER 350, PHONE 400, COMPUTER 450, RADIO 500, RECEIVE QUE 550 and SEND QUE 600 touchpoints. The heading and directional information are displayed in real time and are dynamic. Pressing the FAX touchpoint causes the processor to display a Fax page (shown in FIG. 12) which lists received facsimile messages 301. The Fax page includes display interfaces appropriate for the sending and receiving of facsimile communications through the FAX Phone Modem port 29g, and such displays and functions are well known in the art. Pressing the BEEPER touchpoint causes the processor to display a Beeper page (shown in FIG. 13). The Beeper page displays received beeper messages 351 and allows for the deletion of such messages from the display and internal memory storage. Also, a sub-menu portion of the display 151 is reserved for sub-menus and directories.

Pressing GPS 200 causes the processor 21 to display a GPS Function page 201, which is illustrated in FIG. 7. The GPS page provides for selection of a GPS mode through touch points in the sub-menu portion of the display. The available modes are location 210, show me 230, get map 250 and third party 270 modes. The display returns to the GPS Function page when the PREVIOUS button 27i (shown in FIG. 2) is pressed. The display hierarchy for the GPS functions is illustrated in FIG. 5C. The Location, Show Me, Get Map, and Third Party pages descend from the GPS Menu page. The Location page comprises the current map, the location on the map of the device, and a plot of the trail of the device on the map. The sub-menu portion of the display provides for additional selection of still further pages. These pages include a Menu page, a Mode page, a Waypoint page, and a Preferences page.

The Location page is illustrated in FIG. 8. The Location page includes a GPS map 219 (latitude and longitude encoded coordinate pairs). The sample page shown is an encoded map showing the device position, plot trail and the encoded map location of the selected waypoint. The map displayed could be from on-board memory or sent by other third parties by way of communication links to the PCD. When map data files are encoded with location information, the location information can be referred to as waypoints. These tagged waypoints, with links to other data structures, can then be sent to users via an application to various communication systems. Closed-loop or proprietary GPS receivers can send/receive data to/from other third parties (Brand X, Brand Y) via their own proprietary format using an application system as a universal converter. The location information is dynamic and updated periodically by the PCD's communication system via link-up with GPS-based satellites. The Location page indicates the PCD position 801, indicated by a walking person, as being located on a highway 810. A waypoint 802 is along the highway en route to the desired destination address 803 located on a local street 804 which intersects the highway. A first point of interest 807 is also displayed as being along the highway, as is a second point of interest 805 along a second local road intersecting the highway. The limited GPS information, providing location, heading and north, is also displayed. The illustrated Location page display shows only one possible combination of a map layout. Other display sequences such as North up, course up, user at top of screen, user in middle, and other display sequences are possible. The dynamic nature of the PCD allows the PCD to display GPS encoded maps as the PCD progresses dynamically with relation to the maps.

11

Using interpolation techniques, performing spatial query analysis, and establishing layers for best display scale for any given map record allows the device to provide the user extended capability not possessed by traditional GPS devices. Applying various protocols and interpolation techniques allow files to be arranged geographically by distance from a designated point (usually the requesters latitude and longitude as the starting point, but other locations may also be used). The maps are also arranged in layers, menus, limited, listed, showed, displayed, and sorted.

The Location mode provides typical GPS system functions. The touch points MENU 213, MODE 215 and WAY-POINT 217 and PREFERENCES 221 provide access to the Menu, Mode, Waypoint, and Preferences pages. These pages, along with various buttons on the alphanumeric key pad 26 FIGS. 2 and 4 and special function buttons 27, are used to configure the display to the user's preference. The preferences page 221 enables selection of such features as voice, maps, scroll, off screen maps away from cursor and other features. The listing name 219 portion of the Location page displays information pertaining to a waypoint selected through the use of the cursor.

FIG. 9 illustrates the Show Me page accessed from the GPS page. The Show Me page shows a list of available maps 901a-i stored on-board, which includes maps retrieved from the receive queue area of the PCD memory. The user can load a map into the location or third party pages by pressing the corresponding number key on alphanumeric key pad 26 (shown in FIG. 2) or by scrolling through the list to highlight the appropriate map and then pressing ENTER button 27g. Maps may also be removed from on-board storage using the DELETE button 27h.

FIG. 10 illustrates the Get Map page accessed from the GPS Menu page. The user of the PCD can request the map by location from PCD memory or an external source. The user may enter a desired map location. If a map location is entered, the PCD will only search PCD memory for a map for the entered location. Maps from an external source are downloaded via any of the communication links such as the FAX, BEEPER, PHONE or RADIO touchpoints provided in the sub-menu portion of the display 151. Depending on the users requirements, several maps could exist showing similar map areas with different layers for viewing. By way of example, airport maps with air space requirements, coastal waterway, maps, and interstate maps, and even hand drawn maps scanned into a computer system all show different resources within a given geographic area. These maps, when presented on the PCD, could over-saturate the display map detail for any given map area. Therefore, it is preferred that the actual map displayed be selectable. Maps are retrieved by pressing QUE IN 550, scrolling to highlight the desired map, and pressing ENTER 27g FIG. 2.

FIG. 11 illustrates the Third Party page accessed from the GPS menu page. The Third Party page provides an interface to communications with a third party through touch points in the sub-menu display 151. In the display shown, a user can receive a third party's data and GPS encoded map for viewing on the device or save it for future usage. The user can also dynamically track the third party by periodically having the third party send updates via normal communication links. The third party location can be displayed on maps dynamically sent by map publishers, maps already on-board (furnished at some earlier date), or on maps sent by the third party. The PCD plots and interpolates the GPS data sent by the third party and places an icon 951 (GPS latitude and longitude coordinate pair) on the displayed map using spatial query analysis techniques performed by an applica-

12

tion module. The information received from the third party may be other than maps or GPS encoded information, but may be information of any type. The data is received from the third party using phone 400 and radio communication links 500. A PREFERENCES touch point 274 enables entry of items such as phone numbers for automatic call back and time interval for automatic transmission of information. If the radio, a satellite phone, or other frequency based communications link is utilized, the PREFERENCES touch point allows entry of frequencies for use for automatic transmission of information. A split screen displays the user's location on a map on the left side of display 272 and, after contact with a third party via a communication link, the third party's map and location on the right side of display 273. If the third party's location is sufficiently close to the user's location, or if the user's displayed map covers a sufficiently large area, both the user's and third party's location can be shown on the same map without resort to a split screen display.

FIG. 32 illustrates a Weather Map Request page. The Weather Map Request page is accessed by pressing the Weather button 27n (shown in FIG. 2) on the PCD. The Weather Map Request page allows the PCD user to specify the map location and scale, the map type, whether the selected map should be automatically updated at specified intervals, and whether a set of maps should be displayed in a sequential fashion. The PCD displays a number of different types of weather maps, including satellite images, radar maps, temperature maps, wind chill maps, and any other type of weather map available. Some weather information is more perfectly provided by showing a sequence of displays indicating the change in weather over time. Therefore, the PCD allows the operator to sequentially display a set of maps, thus providing an animated map display.

FIG. 33 illustrates a weather reporting device. The weather reporting device has a power port 334 to provide electrical power to the weather reporting device. As with the PCD, the weather reporting device may also be powered by a battery (not shown). The weather reporting device also has a computer port 335, an interface port 333, an antenna port 332, a pressure access port 331a, and a number of auxiliary ports 331b-e. The computer port provides a communications interface to a standard personal computer or the PCD. The interface port provides an interface to systems with weather detection features, such as aircraft with weather radars or lightning strike finders. The antenna port allows an external antenna to be connected to the weather reporting device, thereby providing remote operation capability. The pressure access port provides external access for an internal pressure sensitive device (not shown) for the determination of barometric pressure. A plurality of auxiliary input ports 331b-e provide an interface for connecting the weather reporting device to external weather detection sensors such as temperature sensors, wind sensors, and other weather sensing devices.

The Fax page is accessed by pressing the FAX touchpoint on the Main Menu page. FIG. 12 illustrates the Fax page. The sub-menu portion of the display is available for listing previously stored phone numbers. These phone numbers are selectable as a facsimile destination. In addition, the user can directly enter the phone number to indicate the facsimile destination. As with other pages, the PCD continues to dynamically display the limited GPS information of location, north and heading. The PCD facsimile function is performed by application software executed by the processor. Multiple fax locations, time set, send after certain time, and other traditional functions of fax machines and their

implementation are well known in the art. The Fax page provides for display of a message (not shown) entered via the alphanumeric key pad **26** (shown in FIG. 2) or through selection of messages stored in the send queue area of device memory. Messages stored in the queue area of PCD memory can be selected by scrolling through a directory **305** of all fax messages stored. To view a stored message the user uses the SCROLL button **27a** (shown in FIG. 2) to highlight an entry, and then press ENTER button **27g**. Pressing the SEND button **27b** transmits the selected or entered facsimile. The user may also view received faxes using this mode by pressing QUE IN **550** FIG. 12, using the SCROLL button **27a** to highlight the desired message, and pressing the ENTER button **27g**.

The Beeper page is accessed from the Main Menu page. Pressing the BEEPER touch point on the Main Menu page causes the processor to display the Beeper page. The device contains capabilities consistent with common practices of beepers, also known as pagers, such as sending and receiving messages. These functions and their implementation are well known in the art. The PCD is also satellite communications capable. Beeper messages can be received by the PCD without interference to the other device capabilities. Therefore, the user could continue using the telephone or other features seemingly uninterrupted by the reception of digital beeper messages and display of those messages. The Beeper page provides a list of beeper messages (not shown) stored in the receive queue area. Messages stored in the receive queue can be selected by scrolling through listing **353** FIG. 13 of all beeper messages stored. To view a stored message, the user uses the SCROLL button to highlight a desired message and presses the ENTER button **27g**. Messages are deleted when the DELETE button is pressed with at least one message selected.

The Phone page is illustrated in FIG. 14. The Phone page is accessed from the Main Menu page. Pressing the PHONE touchpoint on the Main Menu page causes the processor to display the Phone page. The Phone page is also accessed by pressing the PHONE touchpoint on the Get Map and Third Party pages. As with the other pages, the limited GPS data is continuously displayed showing PCD location, heading, and north. The PCD can access several areas of the display even while the PCD is being used as a telephone. Information provided in the display area **1401** will vary depending upon the page from which the phone page was accessed. The Phone page provides for selection of a function through touch points displayed in the sub-menu portion of the display. The selectable touchpoints are: POLICE **403**, MEDICAL **405**, DATA PROVIDER **407**, DIRECTORY **413**, and MEMORY **415**.

When the POLICE touchpoint is pressed, the PCD places a call to emergency 911. The 911 telephone number is the default, another number could instead have been entered for any particular user through the preferences selection. Once the telephone call is answered, the PCD provides the information entered using the Preferences function and the device location. The user may also establish voice and data communications through the microphone **34** and speaker **33** (shown in FIG. 3).

The PCD performs equivalent functions when the MEDICAL touchpoint is pressed. As different phone numbers and information can be entered in the selection of user preferences, however, different phone numbers may be used and different information may be transmitted.

When the DATA PROVIDER touchpoint is pressed, the processor displays the Data Provider Connect page. The

Data Provider Connect page provides a means to specify the type and amount of data to be downloaded from a specified data provider. The Data Provider Connect page has numerous data fields which are selected by use of the cursor. Once a field is selected, the user may enter data in that field using the alphanumeric keys. The data fields include data for name, city, state, map area, zip code, telephone area code, retail category, distance from device location, and maximum number of listings to be provided by the data supplier. Whether a map only is requested and what particular types of maps, such as interstate maps, walking area maps, zip code maps, street maps, area code maps, or state maps, are requested are also provided as options. Touch points for weather information and traffic reports are also provided. Once the appropriate data fields and/or type of data required is input or selected, pressing the send key transmits the data request to the data provider. Details regarding the method of transmission of the responsive data is automatically sent by the data provider to the data provider along with the data request.

The primary data providers may include the public telephone company networks but may also include other entities. The data providers maintain data, including maps, telephone yellow page entries, and other information such as traffic and weather reports. This information is maintained in a timely manner and is accessible through the use of data base methods well known in those in the art. Upon receiving a request for data, the data provider determines the nature of the data request, searches the appropriate data base or data bases, and transmits the requested information to the requesting device in the manner specified by the requesting device. The user, after the PCD receives the data as requested, disconnects, goes off line to review the information, deleting some, saving others, and storing other encoded information on the PCD. The user can now further edit the device's entire data base and decide a sequence for navigating to the locations listed in the various menus as waypoints. Thus users of the PCD can decide to navigate using the GPS features of the PCD and select certain waypoints and the order in which to proceed. By way of example, but not limited to same, users could select gas stations, banks, restaurants, shopping centers in unfamiliar areas, navigate today from one point of beginning and tomorrow continue navigating from another point of beginning, being assured that the device will always know how to get to various locations. Should the user require further locations to visit, the PCD is capable of obtaining new navigational data and adding to the already active route plan without having to completely start over.

Pressing the DIRECTORY touchpoint **413** displays an alphabetical listing (not shown) of phone numbers stored on-board. The user may scroll through the listing and select a desired phone number. Pressing MEMORY **415**, displays an alphabetical listing (not shown) of frequently used phone numbers. The user may scroll through the listing and select a desired number. Pressing the SEND button causes the device to dial the selected phone number.

FIG. 16 illustrates the Computer page. The Computer page is accessed by pressing the COMPUTER touchpoint **450** (shown in FIG. 6) on the Main Menu page. The Computer page allows the user to operate the device as a standard personal computer utilizing application programs of the type normally present on personal computers. As examples, the display of FIG. 16 provides for touchpoints in the sub-menu portion of the display for calendar date entry, notes, and organizer application programs. As with the other pages, the limited GPS information is also displayed.

15

FIG. 17 illustrates the Radio page. The Radio page is accessed by pressing the RADIO touchpoint 500 on the Main Menu page. The radio mode provides the user with an interface for selecting the type of radio signal through touch points displayed in the sub-menu 151 area. The selectable types are: AM 503, FM 507 and TRANSCEIVER 511. Selecting any type will display a page (not shown) requesting frequency, volume, and other parameters relating to radio transmission and reception. The AM and FM are standard receivers. The device can thereby tune and listen to broadcasts that provide data links and receive data files using legal AM or FM radio bands (or any other radio band legal to access and provide radio station information). The device therefore allows users to communicate information amongst themselves without having to rely on telephone technology. This is especially valuable when telephone technology is not available.

The Receive Queue page displays stored received messages. The received messages may be displayed by reception type through selection of the transmission line type listed in the sub-menu portion of the display, the selectable types, through touch points displayed in the sub-menu 151 area, are: ALL 553, FAX 555, BEEPER 557, PHONE 559, COMPUTER 561 and RADIO 563. Selecting a type, will sort (by specified type) and display (by date and time) all messages received. By way of example, the radio queue contains GPS-encoded voice mail or digital files (containing information to various sites) provided by private third-party sources. The phone system queue contains previous calls with digital messages linked to web pages containing voice and video data. The computer which may be queued contains personal letters, calendars, notes and the like from more traditional sources or user created tagged files for storage. The fax queue contains traditional faxes which may illustrate maps with waypoints. The beeper mode queue contains received beeper messages (digital and voice).

The Send Queue page is accessed by pressing the SEND QUE touchpoint on the Main Menu page. The Send Queue page includes similar functions as the receive queue, except the Send Queue is a staging area for sending messages. The Send Queue page displays sent or to-be-sent data and an interface for selecting the specific type of queue. The selectable types, through touch points displayed in the sub-menu portion of the display 151, are: ALL 603, FAX 605, BEEPER 607, PHONE 609, COMPUTER 611 and RADIO 613. Selecting a type, will sort (by specified type) and display (by date and time) all messages sent or waiting to be sent.

FIGS. 23A and B are a system block diagram including a block diagram of a data provider. A plurality of PCDs 231, 232, 233 communicate with each other using the aforementioned communication means. The PCDs also communicate with various data base information suppliers including private data base information suppliers, publisher data base information suppliers, telephone service data base information suppliers, and a data base provider. The data base provider receives digital requests for map information or other data regarding a geographic area. The data provider collects map data and other data and tags the other data to the map data and maintains the map and location tagged data in a data base. Human intervention is not required in responding to data requests.

As shown in FIG. 23B, the application module of the device is ported to a computer system not GPS capable, or merely not portable so as to have no need for a GPS receiver. The application module allows non-PCD based computer users to provide data to the data provider in the correct

16

format, as well as receive data from devices or the data provider. This allows the non-device base computer user to track the location of devices and to collect information to be manually entered into a traditional GPS capable device as an aid in future trip planning.

FIG. 20 illustrates a list of GPS encoded data for a restaurant listing of restaurants in a requested area. This list may have been furnished by third parties or a data provider. The PCD has stored this information in digital format and is displayed on a GEO coded map, GIFF map or any other map the PCD stored in memory or receives from a third party or data provider. The information can be arranged by the PCD using criteria enabling the user unlimited access to the data. If the user chooses to navigate to these locations singularly or as a group, the GPS engine performs these functions, allowing a user of the device to accurately travel to the desired restaurant. As shown in FIG. 21, the PCD can use any scale of map or combinations and other types of maps as shown. The user of the PCD selects certain maps for storage and recalls same when needed for navigation. By way of example, the user's device could have a local Los Angeles street map, an interstate map (as shown in FIG. 21), and a New York city map in device memory. The user could navigate to the airport using the GPS functions and stored Los Angeles map, fly to New Jersey, rent a car and navigate to New York using the interstate map and, finally, find a specific restaurant in New York City by using the third map stored in PCD memory.

As shown in FIG. 22, the PCD contains a map with various waypoint locations the user has selected. These waypoints are both standard waypoints 221 and linked waypoints 222. The waypoints are indicated by a marker on the display. Standard waypoints indicate identifiable locations of interest. Linked waypoints have additional data associated with the waypoint. The additional data may be text data, visual data such as a photographic image of the waypoint, or an audio data file. When the marker for the linked waypoint is selected using the touch screen or other input device, the processor determines if the additional data associated with the waypoint is available in the PCD memory. If the additional data is not available in the PCD memory, the PCD automatically requests the additional data from a data provider. Once the additional data is available, the PCD displays or otherwise makes use of the additional data.

Using the map of FIG. 22, the user could navigate to a school, restaurant, bank, gas station, government office using the PCD to interpolate using spatial query techniques to find the best routes to each location. The PCD can re-collate the list for the most efficient route using the application and GPS engine modules. Using software programming techniques and math formulas, persons skilled in the arts will utilize spatial analysis queries and functions to determine best routing and "closest to" scenarios. In addition, centroid interpolation functions and match-rate comparison functions used by the GEO coding community will further enhance this application's ability to universally communicate with other systems.

FIG. 30 further illustrates a system whereby the user uses a PCD to dial a direct access number similar to dialing 411, but all requests are requested and serviced automatically. Upon connection to the system, the user makes keyboard requests to the PCD or traditional computer system using the application program of the PCD. Upon requests being received by the data provider or similar information provider, the provider or supplier searches the data base for data responsive to the request. The provider or supplier can

access further data through data links to other third party sources and continue to provide all data required by the requester. This system is consistent with the world wide web, linking data through hypertext connections and designations. This invention's system converts information requests to data requests, not verbal requests, as presently being practiced in directory assistance type services. This narrow usage of the application module allows convenient access to directory assistance that primarily provides data and chunks of information in a short period of time consistent with directory assistance today.

FIG. 31 shows a web page screen with a data provider icon displayed on the device. Pressing or otherwise selecting the icon will enable a menu for the requester to specify a data request. Download will be in the form of a compressed digital data file that may include video, sound, or other digitally encoded data.

While this invention has been described with reference to illustrative embodiments, this description is not intended to be construed in any limiting sense. Various other embodiments of the invention will be apparent to persons skilled in the art upon reference to this description. It is therefore contemplated that the appended claims will cover any such modifications of the embodiments as fall within the true scope and spirit of the invention.

What is claimed is:

1. A location tagged information storage and transceiver system comprising:

a transceiver, the transceiver receiving digital data from a personal digital communication device and transmitting digital data to the personal digital communication device;

a computer processor;

computer memory for storing map data for geographic areas and non-map data, with the non-map data in linked data fields concerning specific locations within the geographic areas for which map data is available, the non-map data tagged to the map data;

a sorting application module executed by the computer processor, the sorting application module responsive to requests from the personal digital communication device, the requests being for a specified maximum number of specified non-map data concerning specified geographic areas, the sorting application module searching the computer memory by data fields for the specified non-map data and providing the specified non-map data and map data linked to the specified non-map data to the transceiver for transmission to the personal digital communication device.

2. The location tagged information storage and transceiver system of claim 1 further comprising a linking and tagging module executed by the processor for linking data pertaining to a specific geographic location in linked data

fields and tagging the linked data fields with a marker indicative of geographic location.

3. The location tagged information storage and transceiver system of claim 1 wherein the specified non-map data includes restaurant listings.

4. The location tagged information storage and transceiver system of claim 1 wherein the specified non-map data includes hours of operation.

5. The location tagged information storage and transceiver system of claim 1 wherein the specified non-map data includes traffic reports.

6. The location tagged information storage and transceiver system of claim 1 wherein the specified non-map data includes weather reports.

7. The location tagged information storage and transceiver system of claim 1 wherein the specified non-map data includes yellow page entries.

8. A method for storing and transmitting geo-relevant information comprising:

storing map data for geographic areas and non-map data, with the non-map data in linked data fields concerning specific locations within the geographic areas;

receiving a request from a user for a specified maximum number of listings of non-map data;

searching the map data and the non-map data to obtain specific map data and non-map data in response to the request; and

automatically transmitting the specific map data and up to the maximum number of listings of non-map data to the user.

9. The method for storing and transmitting geo-relevant information of claim 8 wherein the non-map data includes restaurant listings.

10. The method for storing and transmitting geo-relevant information of claim 8 wherein the non-map data includes hours of operation.

11. The method for storing and transmitting geo-relevant information of claim 8 wherein the non-map data includes traffic reports.

12. The method for storing and transmitting geo-relevant information of claim 8 wherein the non-map data includes weather reports.

13. The method for storing and transmitting geo-relevant information of claim 8 wherein the non-map data includes yellow page entries.

14. The method for storing and transmitting geo-relevant information of claim 8 wherein the map data includes latitude and longitude data.

15. The method for storing and transmitting geo-relevant information of claim 8 wherein the request includes information indicating a specified manner of transmission to the user of the specific map data and non-map data.

* * * * *