



US007916444B2

(12) **United States Patent**
Anthony et al.

(10) **Patent No.:** **US 7,916,444 B2**
(45) **Date of Patent:** **Mar. 29, 2011**

(54) **ARRANGEMENT FOR ENERGY
CONDITIONING**

(75) Inventors: **Anthony A. Anthony**, Erie, PA (US);
William M. Anthony, Erie, PA (US)

(73) Assignee: **X2Y Attenuators, LLC**, Erie, PA (US)

(*) Notice: Subject to any disclaimer, the term of this patent is extended or adjusted under 35 U.S.C. 154(b) by 0 days.

(21) Appl. No.: **12/848,676**

(22) Filed: **Aug. 2, 2010**

(65) **Prior Publication Data**

US 2010/0294555 A1 Nov. 25, 2010

Related U.S. Application Data

(63) Continuation of application No. 12/554,976, filed on Sep. 7, 2009, now Pat. No. 7,768,763, which is a continuation of application No. 11/866,437, filed on Oct. 3, 2007, now abandoned, which is a continuation of application No. 11/296,391, filed on Dec. 8, 2005, now Pat. No. 7,321,485, which is a continuation of application No. 10/189,339, filed on Jul. 2, 2002, now Pat. No. 7,110,235, which is a continuation-in-part of application No. 10/115,159, filed on Apr. 2, 2002, now Pat. No. 6,894,884, which is a continuation-in-part of application No. 09/845,680, filed on Apr. 30, 2001, now Pat. No. 6,580,595, which is a continuation-in-part of application No. 09/777,021, filed on Feb. 5, 2001, now Pat. No. 6,687,108, which is a continuation-in-part of application No. 09/632,048, filed on Aug. 3, 2000, now Pat. No. 6,738,249, which is a continuation-in-part of application No. 09/594,447, filed on Jun. 15, 2000, now Pat. No. 6,636,406, which is a continuation-in-part of application No. 09/579,606, filed on May 26, 2000, now Pat. No. 6,373,673, which is a continuation-in-part of application No. 09/460,218, filed on Dec. 13, 1999, now Pat. No. 6,331,926, which is a continuation of

application No. 09/056,379, filed on Apr. 7, 1998, now Pat. No. 6,018,448, which is a continuation-in-part of application No. 09/008,769, filed on Jan. 19, 1998, now Pat. No. 6,097,581, which is a continuation-in-part of application No. 08/841,940, filed on Apr. 8, 1997, now Pat. No. 5,909,350.

(60) Provisional application No. 60/280,819, filed on Apr. 2, 2001, provisional application No. 60/302,429, filed on Jul. 2, 2001, provisional application No. 60/310,962, filed on Aug. 8, 2001, provisional application No. 60/349,954, filed on Jan. 18, 2002, provisional application No. 60/388,388, filed on Jun. 12, 2002.

(51) **Int. Cl.**
H02H 9/00 (2006.01)

(52) **U.S. Cl.** **361/118**

(58) **Field of Classification Search** 361/118
See application file for complete search history.

(56) **References Cited**

U.S. PATENT DOCUMENTS

3,240,621 A 3/1966 Flower, Jr. et al.
(Continued)

FOREIGN PATENT DOCUMENTS

DE 197 28 692 A1 1/1999
(Continued)

OTHER PUBLICATIONS

Oct. 1, 2002, PCT International Search Report of PCT/US01/48861.
(Continued)

Primary Examiner — Stephen W Jackson
(74) *Attorney, Agent, or Firm* — Kenneth C. Spafford

(57) **ABSTRACT**

Circuit arrangement embodiments that use relative groupings of energy pathways that include shielding circuit arrangements that can sustain and condition electrically complementary energy confluences.

49 Claims, 7 Drawing Sheets

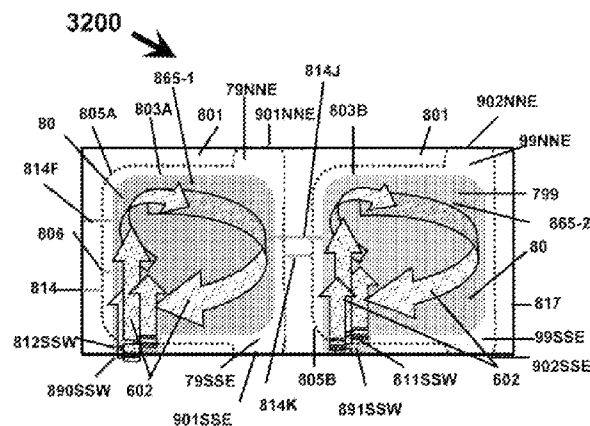

U.S. PATENT DOCUMENTS					
3,343,034 A	9/1967	Ovshinsky	5,059,140 A	10/1991	Philippson et al.
3,379,943 A	4/1968	Breedlove	5,065,284 A	11/1991	Hernandez
3,573,677 A	4/1971	Detar	5,073,523 A	12/1991	Yamada et al.
3,736,471 A	5/1973	Donze et al.	5,079,069 A	1/1992	Howard et al.
3,742,420 A	6/1973	Harnden, Jr.	5,079,223 A	1/1992	Maroni
3,790,858 A	2/1974	Brancaleone et al.	5,079,669 A	1/1992	Williams
3,842,374 A	10/1974	Schlicke	5,089,688 A	2/1992	Fang et al.
4,023,071 A	5/1977	Fussell	5,105,333 A	4/1992	Yamano et al.
4,119,084 A	10/1978	Eckels	5,107,394 A	4/1992	Naito et al.
4,135,132 A	1/1979	Tafford	5,109,206 A	4/1992	Carlile
4,139,783 A	2/1979	Engeler	5,140,297 A	8/1992	Jacobs et al.
4,191,986 A	3/1980	ta Huang et al.	5,140,497 A	8/1992	Kato et al.
4,198,613 A	4/1980	Whitley	5,142,430 A	8/1992	Anthony
4,259,604 A	3/1981	Aoki	5,148,005 A	9/1992	Fang et al.
4,262,317 A	4/1981	Baumbach	5,155,655 A	10/1992	Howard et al.
4,275,945 A	6/1981	Krantz et al.	5,161,086 A	11/1992	Howard et al.
4,292,558 A	9/1981	Flick et al.	5,162,977 A	11/1992	Paurus et al.
4,308,509 A	12/1981	Tsuchiya et al.	5,167,483 A	12/1992	Gardiner
4,320,364 A	3/1982	Sakamoto et al.	5,173,670 A	12/1992	Naito et al.
4,335,417 A	6/1982	Sakshaug et al.	5,179,362 A	1/1993	Okochi et al.
4,353,044 A	10/1982	Nossek	5,181,859 A	1/1993	Foreman et al.
4,366,456 A	12/1982	Ueno et al.	5,186,647 A	2/1993	Denkmann et al.
4,384,263 A	5/1983	Neuman et al.	5,206,786 A	4/1993	Lee
4,394,639 A	7/1983	McGalliard	5,208,502 A	5/1993	Yamashita et al.
4,412,146 A	10/1983	Futterer et al.	5,219,812 A	6/1993	Doi et al.
4,494,092 A	1/1985	Griffin et al.	5,220,480 A	6/1993	Kershaw, Jr. et al.
4,533,931 A	8/1985	Mandai et al.	5,236,376 A	8/1993	Cohen
4,553,114 A	11/1985	English et al.	5,243,308 A	9/1993	Shusterman et al.
4,563,659 A	1/1986	Sakamoto	5,251,092 A	10/1993	Brady et al.
4,586,104 A	4/1986	Standler	5,257,950 A	11/1993	Lenker et al.
4,587,589 A	5/1986	Marek	5,261,153 A	11/1993	Lucas
4,590,537 A	5/1986	Sakamoto	5,262,611 A	11/1993	Danysh et al.
4,592,606 A	6/1986	Mudra	5,268,810 A	12/1993	DiMarco et al.
4,612,140 A	9/1986	Mandai	5,290,191 A	3/1994	Foreman et al.
4,612,497 A	9/1986	Ulmer	5,299,956 A	4/1994	Brownell et al.
4,636,752 A	1/1987	Saito	5,300,760 A	4/1994	Batliwalla et al.
4,682,129 A	7/1987	Bakermans et al.	5,310,363 A	5/1994	Brownell et al.
4,685,025 A	8/1987	Carlomagno	5,311,408 A	5/1994	Ferchau et al.
4,688,151 A	8/1987	Kraus et al.	5,319,525 A	6/1994	Lightfoot
4,694,265 A	9/1987	Kupper	5,321,373 A	6/1994	Shusterman et al.
4,698,721 A	10/1987	Warren	5,321,573 A	6/1994	Person et al.
4,703,386 A	10/1987	Speet et al.	5,326,284 A	7/1994	Bohbot et al.
4,712,062 A	12/1987	Takamine	5,337,028 A	8/1994	White
4,713,540 A	12/1987	Gilby et al.	5,353,189 A	10/1994	Tomlinson
4,720,760 A	1/1988	Starr	5,353,202 A	10/1994	Ansell et al.
4,746,557 A	5/1988	Sakamoto et al.	5,357,568 A	10/1994	Pelegris
4,752,752 A	6/1988	Okubo	5,362,249 A	11/1994	Carter
4,760,485 A	7/1988	Ari et al.	5,362,254 A	11/1994	Siemon et al.
4,772,225 A	9/1988	Ulery	5,378,407 A	1/1995	Chandler et al.
4,777,460 A	10/1988	Okubo	5,382,928 A	1/1995	Davis et al.
4,780,598 A	10/1988	Fahey et al.	5,382,938 A	1/1995	Hansson et al.
4,782,311 A	11/1988	Ookubo	5,386,335 A	1/1995	Amano et al.
4,789,847 A	12/1988	Sakamoto et al.	5,396,201 A	3/1995	Ishizaki et al.
4,793,058 A	12/1988	Venaleck	5,401,952 A	3/1995	Sugawa
4,794,485 A	12/1988	Bennett	5,405,466 A	4/1995	Naito et al.
4,794,499 A	12/1988	Ott	5,414,393 A	5/1995	Rose et al.
4,795,658 A	1/1989	Kano et al.	5,414,587 A	5/1995	Kiser et al.
4,799,070 A	1/1989	Nishikawa	5,420,553 A	5/1995	Sakamoto et al.
4,801,904 A	1/1989	Sakamoto et al.	5,432,484 A	7/1995	Klas et al.
4,814,295 A	3/1989	Mehta	5,446,625 A	8/1995	Urbish et al.
4,814,938 A	3/1989	Arakawa et al.	5,450,278 A	9/1995	Lee et al.
4,814,941 A	3/1989	Speet et al.	5,451,919 A	9/1995	Chu et al.
4,819,126 A	4/1989	Kornrumpf et al.	RE35,064 E	10/1995	Hernandez
4,845,606 A	7/1989	Herbert	5,455,734 A	10/1995	Foreman et al.
4,847,730 A	7/1989	Konno et al.	5,461,351 A	10/1995	Shusterman
4,904,967 A	2/1990	Morii et al.	5,463,232 A	10/1995	Yamashita et al.
4,908,586 A	3/1990	Kling et al.	5,471,035 A	11/1995	Holmes
4,908,590 A	3/1990	Sakamoto et al.	5,477,933 A	12/1995	Nguyen
4,924,340 A	5/1990	Sweet	5,481,238 A	1/1996	Carsten et al.
4,942,353 A	7/1990	Herbert et al.	5,483,407 A	1/1996	Anastasio et al.
4,967,315 A	10/1990	Schelhorn	5,483,413 A	1/1996	Babb
4,978,906 A	12/1990	Herbert et al.	5,488,540 A	1/1996	Hatta
4,990,202 A	2/1991	Murata et al.	5,491,299 A	2/1996	Naylor et al.
4,999,595 A	3/1991	Azumi et al.	5,493,260 A	2/1996	Park
5,029,062 A	7/1991	Capel	5,495,180 A	2/1996	Huang et al.
5,034,709 A	7/1991	Azumi et al.	5,500,629 A	3/1996	Meyer
5,034,710 A	7/1991	Kawaguchi	5,500,785 A	3/1996	Funada
5,051,712 A	9/1991	Naito et al.	5,512,196 A	4/1996	Mantese et al.
			5,531,003 A	7/1996	Seifried et al.

5,534,837 A	7/1996	Brandt	6,016,095 A	1/2000	Herbert
5,535,101 A	7/1996	Miles et al.	6,018,448 A	1/2000	Anthony
5,536,978 A	7/1996	Cooper et al.	6,021,564 A	2/2000	Hanson
5,541,482 A	7/1996	Siao	6,023,406 A	2/2000	Kinoshita et al.
5,544,002 A	8/1996	Iwaya et al.	6,031,710 A	2/2000	Wolf et al.
5,546,058 A	8/1996	Azuma et al.	6,034,576 A	3/2000	Kuth
5,548,255 A	8/1996	Spielman	6,034,864 A	3/2000	Naito et al.
5,555,150 A	9/1996	Newman, Jr.	6,037,846 A	3/2000	Oberhammer
5,568,348 A	10/1996	Foreman et al.	6,038,121 A	3/2000	Naito et al.
5,570,278 A	10/1996	Cross	6,042,685 A	3/2000	Shinada et al.
5,583,359 A	12/1996	Ng et al.	6,046,898 A	4/2000	Seymour et al.
5,586,007 A	12/1996	Funada	6,052,038 A	4/2000	Savicki
5,590,016 A	12/1996	Fujishiro	6,061,227 A	5/2000	Nogi
5,592,391 A	1/1997	Muysshondt et al.	6,064,286 A	5/2000	Ziegner et al.
5,612,657 A	3/1997	Kledzik	6,072,687 A	6/2000	Naito et al.
5,614,881 A	3/1997	Duggal et al.	6,075,211 A	6/2000	Tohya et al.
5,619,079 A	4/1997	Wiggins et al.	6,078,117 A	6/2000	Perrin et al.
5,624,592 A	4/1997	Paustian	6,078,229 A	6/2000	Funada et al.
5,640,048 A	6/1997	Selna	6,084,779 A	7/2000	Fang
5,645,746 A	7/1997	Walsh	6,088,235 A	7/2000	Chiao et al.
5,647,766 A	7/1997	Nguyen	6,091,310 A	7/2000	Utsumi et al.
5,647,767 A	7/1997	Scheer et al.	6,092,269 A	7/2000	Yializis et al.
5,668,511 A	9/1997	Furutani et al.	6,094,112 A	7/2000	Goldberger et al.
5,682,303 A	10/1997	Goad	6,094,339 A	7/2000	Evans
5,692,298 A	12/1997	Goetz et al.	6,097,260 A	8/2000	Whybrew et al.
5,700,167 A	12/1997	Pharney et al.	6,097,581 A	8/2000	Anthony
5,708,553 A	1/1998	Hung	6,104,258 A	8/2000	Novak
5,719,450 A	2/1998	Vora	6,104,599 A	8/2000	Ahiko et al.
5,719,477 A	2/1998	Tomihari	6,108,448 A	8/2000	Song et al.
5,719,750 A	2/1998	Iwane	6,111,479 A	8/2000	Myohga et al.
5,741,729 A	4/1998	Selna	6,120,326 A	9/2000	Brooks
5,751,539 A	5/1998	Stevenson et al.	6,121,761 A	9/2000	Herbert
5,767,446 A	6/1998	Ha et al.	6,125,044 A	9/2000	Cherniski et al.
5,789,999 A	8/1998	Barnett et al.	6,130,585 A	10/2000	Whybrew et al.
5,790,368 A	8/1998	Naito et al.	6,137,392 A	10/2000	Herbert
5,796,568 A	8/1998	Baiatu	6,142,831 A	11/2000	Ashman et al.
5,796,595 A	8/1998	Cross	6,144,547 A	11/2000	Retseptor
5,797,770 A	8/1998	Davis et al.	6,147,587 A	11/2000	Hadano et al.
5,808,873 A	9/1998	Celaya et al.	6,150,895 A	11/2000	Steigerwald et al.
5,822,174 A	10/1998	Yamate et al.	6,157,528 A	12/2000	Anthony
5,825,084 A	10/1998	Lau et al.	6,157,547 A	12/2000	Brown et al.
5,825,628 A	10/1998	Garbelli et al.	6,160,705 A	12/2000	Stearns et al.
5,828,093 A	10/1998	Naito et al.	6,163,454 A	12/2000	Strickler
5,828,272 A	10/1998	Romerein et al.	6,163,456 A	12/2000	Suzuki et al.
5,828,555 A	10/1998	Itoh	6,165,814 A	12/2000	Wark et al.
5,831,489 A	11/1998	Wire	6,175,287 B1	1/2001	Lampen et al.
5,834,992 A	11/1998	Kato et al.	6,180,588 B1	1/2001	Walters
5,838,216 A	11/1998	White et al.	6,181,004 B1	1/2001	Koontz et al.
5,847,936 A	12/1998	Forehand et al.	6,181,231 B1	1/2001	Bartilson
5,867,361 A	2/1999	Wolf et al.	6,183,685 B1	2/2001	Cowman et al.
5,870,272 A	2/1999	Seifried et al.	6,185,091 B1	2/2001	Tanahashi et al.
5,875,099 A	2/1999	Maesaka et al.	6,188,565 B1	2/2001	Naito et al.
5,880,925 A	3/1999	DuPre et al.	6,191,472 B1	2/2001	Mazumder
5,889,445 A	3/1999	Ritter et al.	6,191,475 B1	2/2001	Skinner et al.
5,895,990 A	4/1999	Lau	6,191,669 B1	2/2001	Shigemura
5,898,403 A	4/1999	Saitoh et al.	6,191,932 B1	2/2001	Kuroda et al.
5,898,562 A	4/1999	Cain et al.	6,195,269 B1	2/2001	Hino
5,905,627 A	5/1999	Brendel et al.	6,198,123 B1	3/2001	Linder et al.
5,907,265 A	5/1999	Sakuragawa et al.	6,198,362 B1	3/2001	Harada et al.
5,908,151 A	6/1999	Elias	6,204,448 B1	3/2001	Garland et al.
5,909,155 A	6/1999	Anderson et al.	6,205,014 B1	3/2001	Inomata et al.
5,909,350 A	6/1999	Anthony	6,207,081 B1	3/2001	Sasaki et al.
5,910,755 A	6/1999	Mishiro et al.	6,208,063 B1	3/2001	Horikawa
5,912,809 A	6/1999	Steigerwald et al.	6,208,225 B1	3/2001	Miller
5,917,388 A	6/1999	Tronche et al.	6,208,226 B1	3/2001	Chen et al.
5,926,377 A	7/1999	Nakao et al.	6,208,494 B1	3/2001	Nakura et al.
5,928,076 A	7/1999	Clements et al.	6,208,495 B1	3/2001	Wieloch et al.
5,955,930 A	9/1999	Anderson et al.	6,208,501 B1	3/2001	Ingalls et al.
5,959,829 A	9/1999	Stevenson et al.	6,208,502 B1	3/2001	Hudis et al.
5,959,846 A	9/1999	Noguchi et al.	6,208,503 B1	3/2001	Shimada et al.
5,969,461 A	10/1999	Anderson et al.	6,208,521 B1	3/2001	Nakatsuka
5,977,845 A	11/1999	Kitahara	6,208,525 B1	3/2001	Imasu et al.
5,978,231 A	11/1999	Tohya et al.	6,211,754 B1	4/2001	Nishida et al.
5,980,718 A	11/1999	Van Konynenburg et al.	6,212,078 B1	4/2001	Hunt et al.
5,995,352 A	11/1999	Gumley	6,215,373 B1	4/2001	Novak et al.
5,999,067 A	12/1999	D'Ostilio	6,215,647 B1	4/2001	Naito et al.
5,999,398 A	12/1999	Makl et al.	6,215,649 B1	4/2001	Appelt et al.
6,004,752 A	12/1999	Loewy et al.	6,218,631 B1	4/2001	Hetzel et al.
6,013,957 A	1/2000	Puzo et al.	6,219,240 B1	4/2001	Sasov

6,222,427	B1	4/2001	Kato et al.	7,106,570	B2	9/2006	Anthony, Jr. et al.
6,222,431	B1	4/2001	Ishizaki et al.	7,110,227	B2	9/2006	Anthony et al.
6,225,876	B1	5/2001	Akino et al.	7,110,235	B2	9/2006	Anthony, Jr. et al.
6,226,169	B1	5/2001	Naito et al.	7,113,383	B2	9/2006	Anthony et al.
6,226,182	B1	5/2001	Maehara	7,141,899	B2	11/2006	Anthony et al.
6,229,226	B1	5/2001	Kramer et al.	7,180,718	B2	2/2007	Anthony et al.
6,236,572	B1	5/2001	Teshome et al.	7,193,831	B2	3/2007	Anthony
6,240,621	B1	6/2001	Nellissen et al.	7,224,564	B2	5/2007	Anthony
6,243,253	B1	6/2001	DuPre et al.	7,262,949	B2	8/2007	Anthony
6,249,047	B1	6/2001	Corisis	7,274,549	B2	9/2007	Anthony
6,249,439	B1	6/2001	DeMore et al.	7,301,748	B2	11/2007	Anthony et al.
6,252,161	B1	6/2001	Hailey et al.	7,321,485	B2	1/2008	Anthony et al.
6,262,895	B1	7/2001	Forthun	7,336,467	B2	2/2008	Anthony et al.
6,266,228	B1	7/2001	Naito et al.	7,336,468	B2	2/2008	Anthony et al.
6,266,229	B1	7/2001	Naito et al.	7,423,860	B2	9/2008	Anthony et al.
6,272,003	B1	8/2001	Schaper	7,428,134	B2	9/2008	Anthony
6,281,704	B2	8/2001	Ngai et al.	7,440,252	B2	10/2008	Anthony
6,282,074	B1	8/2001	Anthony	7,443,647	B2	10/2008	Anthony
6,282,079	B1	8/2001	Nagakari et al.	7,586,728	B2	9/2009	Anthony
6,285,109	B1	9/2001	Katagiri et al.	7,593,208	B2	9/2009	Anthony et al.
6,285,542	B1	9/2001	Kennedy, III et al.	7,609,500	B2	10/2009	Anthony et al.
6,288,906	B1	9/2001	Sprietsma et al.	7,609,501	B2	10/2009	Anthony et al.
6,292,350	B1	9/2001	Naito et al.	7,630,188	B2	12/2009	Anthony
6,292,351	B1	9/2001	Ahiko et al.	7,675,729	B2	3/2010	Anthony et al.
6,309,245	B1	10/2001	Sweeney	7,688,565	B2*	3/2010	Anthony et al. 361/118
6,310,286	B1	10/2001	Troxel et al.	7,733,621	B2	6/2010	Anthony et al.
6,313,584	B1	11/2001	Johnson et al.	7,768,763	B2	8/2010	Anthony et al.
6,320,547	B1	11/2001	Fathy et al.	7,782,587	B2	8/2010	Anthony et al.
6,324,047	B1	11/2001	Hayworth	2001/0001989	A1	5/2001	Smith
6,324,048	B1	11/2001	Liu	2001/0002105	A1	5/2001	Brandelik et al.
6,325,672	B1	12/2001	Belopolsky et al.	2001/0002624	A1	6/2001	Khandros et al.
6,327,134	B1	12/2001	Kuroda et al.	2001/0008288	A1	7/2001	Kimura et al.
6,327,137	B1	12/2001	Yamamoto et al.	2001/0008302	A1	7/2001	Murakami et al.
6,331,926	B1	12/2001	Anthony	2001/0008478	A1	7/2001	McIntosh et al.
6,331,930	B1	12/2001	Kuroda	2001/0008509	A1	7/2001	Watanabe
6,342,681	B1	1/2002	Goldberger et al.	2001/0009496	A1	7/2001	Kappel et al.
6,346,743	B1	2/2002	Figuroa et al.	2001/0010444	A1	8/2001	Pahl et al.
6,352,914	B2	3/2002	Ball et al.	2001/0011763	A1	8/2001	Ushijima et al.
6,353,540	B1	3/2002	Akiba et al.	2001/0011934	A1	8/2001	Yamamoto
6,373,673	B1	4/2002	Anthony	2001/0011937	A1	8/2001	Satoh et al.
6,388,207	B1	5/2002	Figuroa et al.	2001/0013626	A1	8/2001	Fujii
6,388,856	B1	5/2002	Anthony	2001/0015643	A1	8/2001	Goldfine et al.
6,395,996	B1	5/2002	Tsai et al.	2001/0015683	A1	8/2001	Mikami et al.
6,448,873	B1	9/2002	Mostov	2001/0017576	A1	8/2001	Kondo et al.
6,456,481	B1	9/2002	Stevenson	2001/0017579	A1	8/2001	Kurata
6,469,595	B2	10/2002	Anthony et al.	2001/0019869	A1	9/2001	Hsu
6,498,710	B1	12/2002	Anthony	2001/0020879	A1	9/2001	Takahashi et al.
6,504,451	B1	1/2003	Yamaguchi	2001/0021097	A1	9/2001	Ohya et al.
6,509,640	B1	1/2003	Li et al.	2001/0022547	A1	9/2001	Murata et al.
6,509,807	B1	1/2003	Anthony et al.	2001/0023983	A1	9/2001	Kobayashi et al.
6,510,038	B1	1/2003	Satou et al.	2001/0024148	A1	9/2001	Gerstenberg et al.
6,522,516	B2	2/2003	Anthony	2001/0028581	A1	10/2001	Yanagisawa et al.
6,549,389	B2	4/2003	Anthony et al.	2001/0029648	A1	10/2001	Ikada et al.
6,559,484	B1	5/2003	Li et al.	2001/0031191	A1	10/2001	Korenaga
6,563,688	B2	5/2003	Anthony et al.	2001/0033664	A1	10/2001	Poux et al.
6,580,595	B2	6/2003	Anthony et al.	2001/0035801	A1	11/2001	Gilbert
6,594,128	B2	7/2003	Anthony	2001/0035802	A1	11/2001	Kadota
6,603,372	B1	8/2003	Ishizaki et al.	2001/0035805	A1	11/2001	Suzuki et al.
6,603,646	B2	8/2003	Anthony et al.	2001/0037680	A1	11/2001	Buck et al.
6,606,011	B2	8/2003	Anthony et al.	2001/0039834	A1	11/2001	Hsu
6,606,237	B1	8/2003	Naito et al.	2001/0040484	A1	11/2001	Kim
6,608,538	B2	8/2003	Wang	2001/0040487	A1	11/2001	Ikata et al.
6,618,268	B2	9/2003	Dibene, II et al.	2001/0040488	A1	11/2001	Gould et al.
6,636,406	B1	10/2003	Anthony	2001/0041305	A1	11/2001	Sawada et al.
6,650,525	B2	11/2003	Anthony	2001/0043100	A1	11/2001	Tomita et al.
6,687,108	B1	2/2004	Anthony et al.	2001/0043129	A1	11/2001	Hidaka et al.
6,696,952	B2	2/2004	Zirbes	2001/0043450	A1	11/2001	Seale et al.
6,717,301	B2	4/2004	DeDaran et al.	2001/0043453	A1	11/2001	Narwankar et al.
6,738,249	B1	5/2004	Anthony et al.	2001/0045810	A1	11/2001	Poon et al.
6,768,630	B2	7/2004	Togashi	2001/0048581	A1	12/2001	Anthony et al.
6,806,806	B2	10/2004	Anthony	2001/0048593	A1	12/2001	Yamauchi et al.
6,873,513	B2	3/2005	Anthony	2001/0048906	A1	12/2001	Lau et al.
6,894,884	B2	5/2005	Anthony, Jr. et al.	2001/0050550	A1	12/2001	Yoshida et al.
6,950,293	B2	9/2005	Anthony	2001/0050600	A1	12/2001	Anthony et al.
6,954,346	B2	10/2005	Anthony	2001/0050837	A1	12/2001	Stevenson et al.
6,995,983	B1	2/2006	Anthony et al.	2001/0052833	A1	12/2001	Enokihara et al.
7,042,303	B2	5/2006	Anthony et al.	2001/0054512	A1	12/2001	Belau et al.
7,042,703	B2	5/2006	Anthony et al.	2001/0054734	A1	12/2001	Koh et al.
7,050,284	B2	5/2006	Anthony	2001/0054756	A1	12/2001	Horiuchi et al.

2001/0054936	A1	12/2001	Okada et al.	JP	57-172130	10/1982
2002/0000521	A1	1/2002	Brown	JP	63-269509	11/1988
2002/0000583	A1	1/2002	Kitsukawa et al.	JP	1-27251	1/1989
2002/0000821	A1	1/2002	Haga et al.	JP	02-267879	11/1990
2002/0000893	A1	1/2002	Hidaka et al.	JP	03-018112	1/1991
2002/0000895	A1	1/2002	Takahashi et al.	JP	5-283284	10/1993
2002/0003454	A1	1/2002	Sweeney et al.	JP	05-299292	11/1993
2002/0005880	A1	1/2002	Ashe et al.	JP	06-053048	2/1994
2002/0024787	A1	2/2002	Anthony	JP	06-053049	2/1994
2002/0027263	A1	3/2002	Anthony et al.	JP	06-053075	2/1994
2002/0027760	A1	3/2002	Anthony	JP	06-053077	2/1994
2002/0044401	A1	4/2002	Anthony et al.	JP	06-053078	2/1994
2002/0075096	A1	6/2002	Anthony	JP	06-084695	3/1994
2002/0079116	A1	6/2002	Anthony	JP	06-151014	5/1994
2002/0089812	A1	7/2002	Anthony et al.	JP	06-151244	5/1994
2002/0113663	A1	8/2002	Anthony et al.	JP	06-151245	5/1994
2002/0122286	A1	9/2002	Anthony	JP	6-302471	10/1994
2002/0131231	A1	9/2002	Anthony	JP	06-325977	11/1994
2002/0149900	A1	10/2002	Anthony	JP	07-022757	1/1995
2002/0158515	A1	10/2002	Anthony, Jr. et al.	JP	07 161568	6/1995
2002/0186100	A1	12/2002	Anthony et al.	JP	07-235406	9/1995
2003/0029632	A1	2/2003	Anthony, Jr. et al.	JP	07-235852	9/1995
2003/0029635	A1	2/2003	Anthony, Jr. et al.	JP	07-240651	9/1995
2003/0048029	A1	3/2003	DeDaran et al.	JP	08-124795	5/1996
2003/0067730	A1	4/2003	Anthony et al.	JP	08-163122	6/1996
2003/0161086	A1	8/2003	Anthony	JP	08-172025	7/1996
2003/0202312	A1	10/2003	Anthony et al.	JP	8172025	7/1996
2003/0206388	A9	11/2003	Anthony et al.	JP	9-266130	10/1997
2003/0210125	A1	11/2003	Anthony	JP	09-284077	10/1997
2003/0231451	A1	12/2003	Anthony	JP	09-284078	10/1997
2003/0231456	A1	12/2003	Anthony et al.	JP	9-294041	11/1997
2004/0004802	A1	1/2004	Anthony et al.	JP	10-12490	1/1998
2004/0008466	A1	1/2004	Anthony et al.	JP	11-97291	4/1999
2004/0027771	A1	2/2004	Anthony	JP	11-21456	8/1999
2004/0032304	A1	2/2004	Anthony et al.	JP	11-214256	8/1999
2004/0054426	A1	3/2004	Anthony	JP	11-223396	8/1999
2004/0085699	A1	5/2004	Anthony	JP	11-219824	10/1999
2004/0105205	A1	6/2004	Anthony et al.	JP	11-294908	10/1999
2004/0124949	A1	7/2004	Anthony et al.	JP	11-305302	11/1999
2004/0130840	A1	7/2004	Anthony	JP	11-319222	11/1999
2004/0218332	A1	11/2004	Anthony et al.	JP	11-345273	12/1999
2004/0226733	A1	11/2004	Anthony et al.	JP	2000-188218	4/2000
2005/0016761	A9	1/2005	Anthony, Jr. et al.	JP	2000-243646	8/2000
2005/0018374	A1	1/2005	Anthony	JP	2000-286665	10/2000
2005/0063127	A1	3/2005	Anthony	WO	WO 91/15046	10/1991
2005/0248900	A1	11/2005	Anthony	WO	WO 97/20332	6/1997
2005/0286198	A1	12/2005	Anthony et al.	WO	WO 97/43786	11/1997
2006/0023385	A9	2/2006	Anthony et al.	WO	WO 98/45921	10/1998
2006/0139836	A1	6/2006	Anthony	WO	WO 99/04457	1/1999
2006/0139837	A1	6/2006	Anthony et al.	WO	WO 99/19982	4/1999
2006/0193051	A1	8/2006	Anthony et al.	WO	WO 99/37008	7/1999
2006/0203414	A1	9/2006	Anthony	WO	WO 99/52210	10/1999
2007/0019352	A1	1/2007	Anthony	WO	WO 00/16446	3/2000
2007/0047177	A1	3/2007	Anthony	WO	WO 2006/099297	9/2000
2007/0057359	A1	3/2007	Anthony et al.	WO	WO 00/65740	11/2000
2007/0103839	A1	5/2007	Anthony et al.	WO	WO 00/74197	12/2000
2007/0109709	A1	5/2007	Anthony et al.	WO	WO 00/77907	12/2000
2008/0160681	A1	7/2008	Anthony et al.	WO	01/06631	1/2001
2009/0321127	A1	12/2009	Anthony et al.	WO	WO 01/10000	2/2001
2010/0078199	A1	4/2010	Anthony et al.	WO	WO 01/41232	6/2001
2010/0180438	A1	7/2010	Anthony et al.	WO	WO 01/41233	6/2001
				WO	WO 01/45119	6/2001
				WO	WO 01/71908	9/2001
				WO	WO 01/75916	10/2001
				WO	WO 01/84581	11/2001
				WO	WO 01/86774	11/2001
				WO	WO 02/59401	1/2002
				WO	WO 02/11160	2/2002
				WO	WO 02/15360	2/2002
				WO	WO 02/27794	4/2002
				WO	WO 02/33798	4/2002
				WO	WO 02/127794	4/2002
				WO	WO 02/45233	6/2002
				WO	WO 02/65606	8/2002
				WO	WO 02/080330	10/2002
				WO	WO 03/005541	1/2003
				WO	WO 2004/070905	8/2004
				WO	WO 2005/002018	1/2005
				WO	WO 2005/015719	2/2005

FOREIGN PATENT DOCUMENTS

DE	198 57 043	C1	3/2000
EP	0623363		11/1994
EP	98915364		11/1994
EP	0776016		5/1997
EP	0933871		8/1999
EP	1022751		7/2000
EP	1024507		8/2000
EP	1061535		12/2000
EP	1128434		8/2001
EP	1873872		12/2008
FR	2496970		6/1982
FR	2606207		5/1988
FR	2765417		12/1998
FR	2808135		10/2001
GB	2217136		4/1988
GB	2341980		3/2000

WO	WO 2005/065097	7/2005
WO	WO 2006/093830	9/2006
WO	WO 2006/093831	9/2006
WO	WO 2006/104613	10/2006
WO	WO 2007/103965	9/2007

OTHER PUBLICATIONS

- Jan. 2, 2003, PCT International Search Report for PCT/US01/44681.
- Jan. 1, 1994, Greb, "An Intuitive Approach to EM Fields," EMC Test & Design, Jan. 1991, pp. 30-33.
- Dec. 1, 1993, Greb, "An Intuitive Approach to EM Coupling," EMC Test & Design, Dec. 1993, pp. 20-25.
- Jun. 1, 1986, Sakamoto, "Noiseproof Power Supplies: What's Important in EMI Removal Filters?" JEE, Jun. 1986, pp. 80-85.
- Jan. 1, 1999, Montrose, "Analysis on Loop Area Trace Radiated Emissions from Decoupling Capacitor Placement on Printed Circuit Boards," IEEE, 1999 pp. 423-.
- Jan. 1, 1999, Miyoshi, "Surface Mounted Distributed Constant Type Noise Filter," IEEE, 1999, pp. 157-160.
- Jan. 1, 1999, Shigetani et al., "Improved EMI Performance by Use of a Three-Terminal-Capacitor Applied to an IC Power Line," IEEE, 1999, pp. 161-164.
- Jul. 19, 1999, PCT International Search Report for PCT/US99/07653.
- Oct. 13, 1999, IPER for PCT/US99/07653.
- U.S. Appl. No. 10/479,506, Claims 1-46 from Preliminary Amendment filed Dec. 10, 2003.
- U.S. Appl. No. 10/189,339, Claims 1-41 from Preliminary Amendment filed Oct. 28, 2003.
- U.S. Appl. No. 10/443,792, Claims 1-41 from Preliminary Amendment filed Oct. 28, 2003.
- Aug. 19, 1998, PCT International Search Report for PCT/US98/06962.
- Apr. 19, 1999, PCT International Search Report for PCT/US99/01040.
- Sep. 18, 2000, PCT International Search Report for PCT/US00/11409.
- Sep. 13, 2000, PCT International Search Report for PCT/US00/14626.
- Nov. 8, 2000, PCT International Search Report for PCT/US00/16518.
- Dec. 28, 2000, PCT International Search Report for PCT/US00/21178.
- Fang et al., "Conductive Polymers Prolong Circuit Life," Design News, date unknown, 3 pages.
- Sep. 1, 1996, Carpenter, Jr. et al., "A New Approach to TVSS Design," Power Quality Assurance, Sep./Oct. 1996 p. 60-63.
- Jan. 1, 1996, Raychem, "Polyswitch Resettable Fuses," Circuit Protection Databook, Jan. 1996, pp. 11-18.
- Dec. 28, 2001, PCT International Search Report for PCT/US01/41720.
- Jun. 13, 2001, PCT International Search Report for PCT/US01/09185.
- Jul. 1, 2000, Polka et al., "Package-Level Interconnect Design for Optimum Electrical Performance," Intel Technology Journal Q3, 2000, pp. 1-17.
- May 10, 2002, PCT International Search Report for PCT/US01/43418.
- Mar. 13, 2002, PCT International Search Report for PCT/US01/32480.
- Aug. 19, 2002, PCT International Search Report for PCT/US02/10302.
- Feb. 28, 2003, PCT International Search Report for PCT/US02/21238.
- Mar. 18, 2002, PCT International Search Report for PCT/US01/13911.
- Jul. 16, 1991, PCT International Search Report for PCT/US91/02150.
- Jun. 28, 2001, PCT International Search Report for PCT/US01/03792.
- Dec. 16, 1998, "Johanson Dielectrics, Inc. Licenses X2Y Circuit Conditioning Technology," Press Release, Dec. 16, 1998, 1 page.
- Mar. 1, 1997, Beyne et al., "PSGA of Record—an innovative IC package for single and multichip designs," Components, Mar. 1997, pp. 6-9.
- Sep. 15, 1997, "EMC Design for Brush Commutated DC Electric Motors," Sep. 15, 1997, pp. 1-2.
- Apr. 1, 1996, "Tomorrow's Capacitors," Components, 1996, No. 4, p. 3.
- Mar. 30, 1998, Mason, "Valor-Understanding Common Mode Noise," Mar. 30, 1998, pp. 1-7.
- Anthony Anthony et al., Pending specification, claims, figures for U.S. Appl. No. 10/237,079, Claims 21-81; filed Sep. 9, 2002.
- David Anthony et al., Pending, specification, claims, figures for U.S. Appl. No. 10/766,000, Claims 1-63, filed Jan. 29, 2004.
- William Anthony, specification, claims, figures for U.S. Appl. No. 10/399,630, Claims 1-35; filed Aug. 27, 2003.
- Anthony Anthony et al., Pending specification, claims, figures for U.S. Appl. No. 10/443,778, Claims 1; 21-59; filed May 23, 2003.
- Anthony Anthony et al., Pending specification, claims, figures for U.S. Appl. No. 10/460,361, Claims 1-20; filed Jun. 13, 2003.
- Anthony Anthony et al., Pending specification, claims, figures for U.S. Appl. No. 10/705,962, Claims 19-33; filed May 25, 2005.
- Anthony Anthony, Pending specification, claims, figures for U.S. Appl. No. 10/369,335, Claims 1-20; Feb. 18, 2003.
- Anthony Anthony et al., Pending specification, claims, figures for U.S. Appl. No. 09/647,648, Claims 1-48; filed Nov. 17, 2000.
- Anthony Anthony, Pending specification, claims, figures for U.S. Appl. No. 10/328,942, Claims 1-20; filed Dec. 23, 2002.
- Anthony Anthony et al., Pending specification, claims, figures for U.S. Appl. No. 09/632,048, Claims 1-20; filed Aug. 3, 2000.
- Anthony Anthony et al., Pending specification, claims, figures for U.S. Appl. No. 09/996,355, Claims 1-73; filed Nov. 29, 2001.
- William Anthony, Pending specification, claims, figures for U.S. Appl. No. 10/023,467, Claims 1-20; filed Dec. 17, 2001.
- Jan. 1, 2005, Weir, et al., "DesignCon 2005, High Performance FPGA Bypass Networks".
- Apr. 25, 2002, Pending claims 1-40 and figures (3 pages) for U.S. Appl. No. 10/399,590; the specification is contained in WO 02/33798, filed Oct. 17, 2001, which is the published version of PCT/US01/32480, which is Neifeld Reference: X2YA0015UPCT-US, which is reference F-063 in the Information Disclosure Statement filed Apr. 23, 2004.
- Feb. 11, 2005, PCT International Search Report for PCT/US04/00218.
- Feb. 18, 2005, PCT International Search Report for PCT/US04/14539.
- Mar. 24, 2005, Australian Patent Office Examination Report for SG 200303041-8; Neifeld Ref: X2YA0025UPCT-SG.
- Apr. 11, 2005, PCT International Search Report for PCT/US04/18938.
- Nov. 2000, Muccioli, "EMC Society Seattle and Oregon Chapters—New X2Y Filter Technology Emerges as Singles Component Solution for Noise Suppression".
- Sep. 27, 2005, PCT Corrected IPER for PCT/US04/00218.
- Nov. 8, 2005, Supplementary Partial European Search Report EP 99916477.
- Oct. 27, 2005, Supplementary European Search Report EP 98915364.
- Dec. 9, 2005, PCT ISR for PCT/US04/39777.
- May 8, 2006, EP Examination Report for 99916477.5-2215.
- PCT Written Opinion of the International Search Authority.
- PCT International Search Report, PCT/US2007/063463.
- Oct. 31, 2007, PCT International Search Report PCT/US06/06609.
- Oct. 31, 2007, PCT Written Opinion of the International Search.
- Jun. 12, 2008, PCT International Search Report PCT/US06/06608.
- Jun. 12, 2008, PCT Written Opinion of the International Search Authority PCT/US06/06608.
- Jun. 12, 2008, PCT International Search Report PCT/US06/06607.
- Jun. 12, 2008, PCT Written Opinion of the International Search Authority PCT/US06/06607.
- Jun. 17, 2008, PCT International Search Report PCT/US06/08901.
- Jun. 17, 2008, PCT Written Opinion of the International Search Authority PCT/US06/08901.
- Jun. 6, 2008, European Search Report EP 07 01 9451.

US 7,916,444 B2

Page 7

Sep. 25, 2008, European Search Report EP 01 99 4116.
Sep. 25, 2008, European Search Report EP 01 99 9170.
Sep. 25, 2008, European Search Report EP 01 99 0677.
Sep. 18, 2008, PCT Written Opinion of the International Search
Authority PCT/US07/063463.
Sep. 25, 2008, European Search Report EP 01 90 8876.
Sep. 25, 2008, European Search Report EP 01 92 2559.

Sep. 25, 2008, European Search Report EP 01 98 1731.
Jan. 24, 1995, Patent Abstracts of Japan, English translation of
abstract for JP 07-022757.
Oct. 13, 2000, Patent Abstracts of Japan, English translation of
abstract for JP 2000-28665.

* cited by examiner

FIG. 1

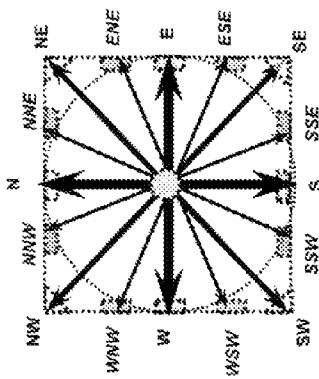

FIG. 1B

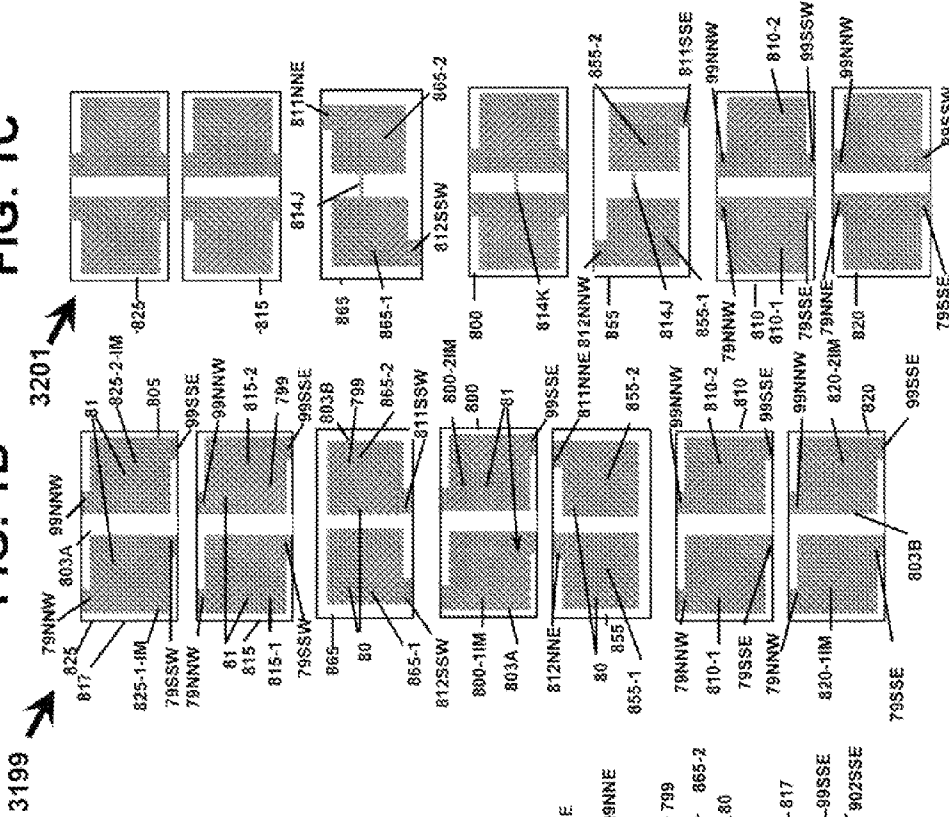
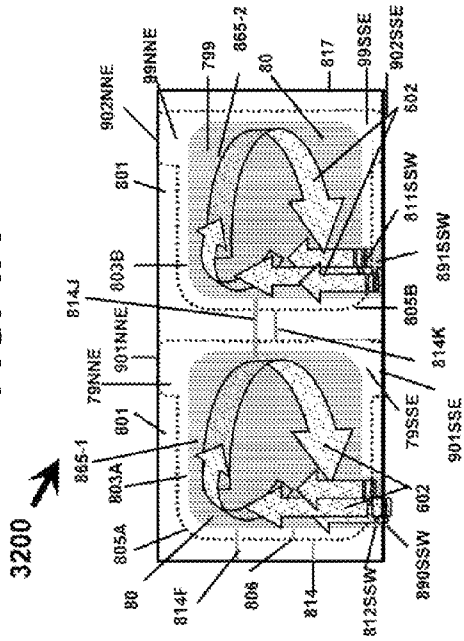

FIG. 1C

FIG. 1A



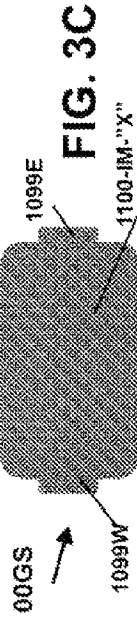

FIG. 3C

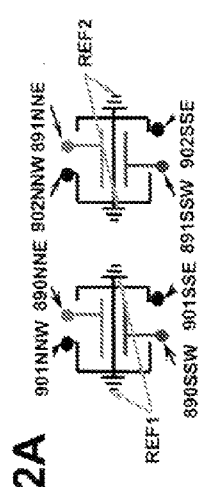

FIG. 2A

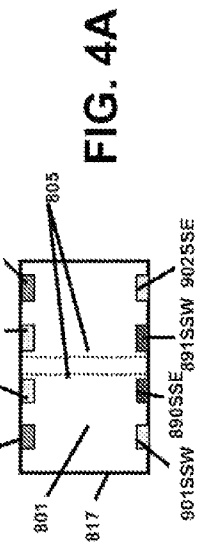

FIG. 4A

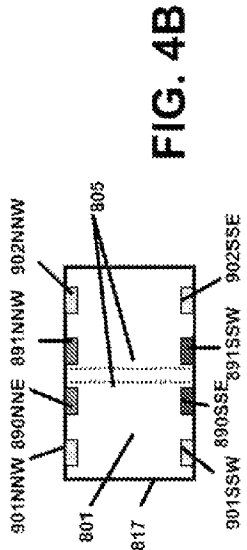

FIG. 4B

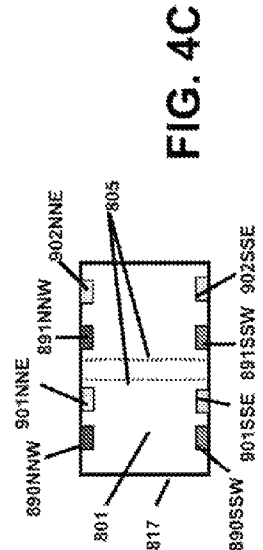

FIG. 4C

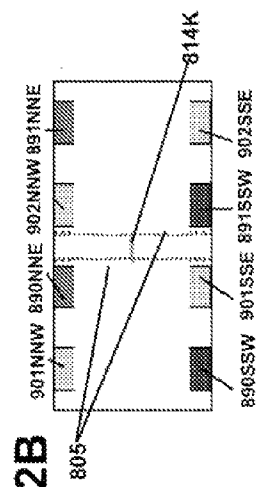

FIG. 2B

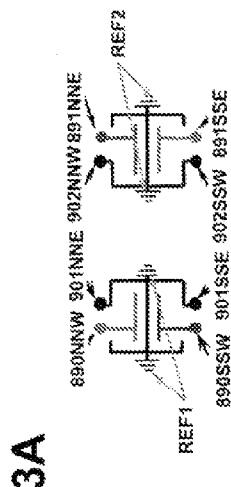

FIG. 3A

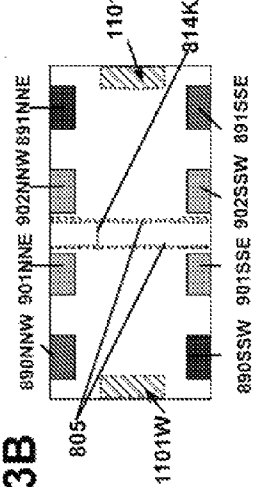

FIG. 3B

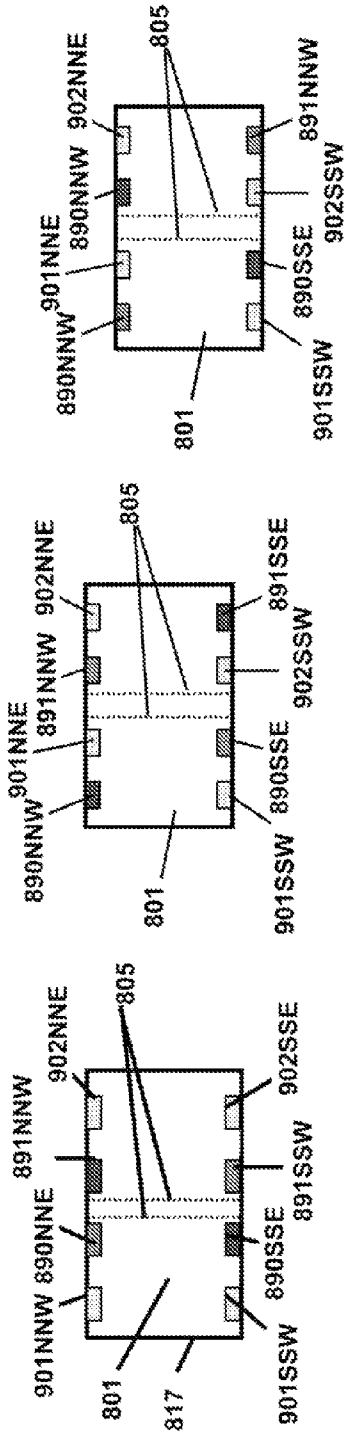

FIG. 4D

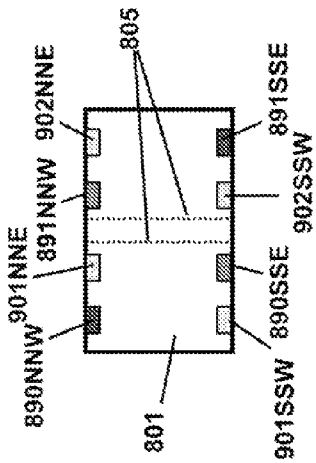

FIG. 4E

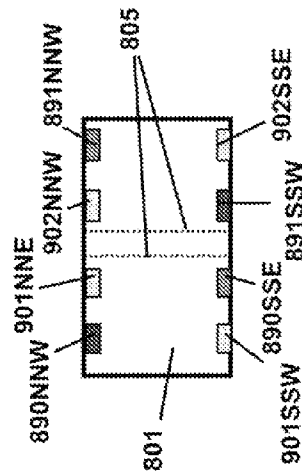

FIG. 4G

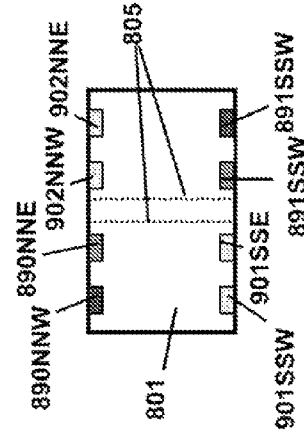

FIG. 4H

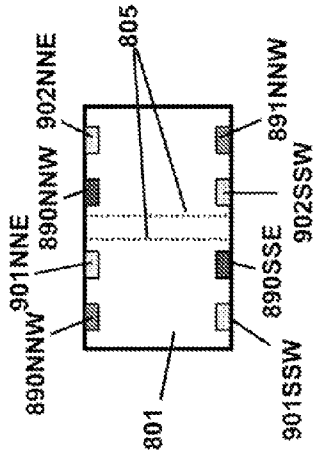

FIG. 4F

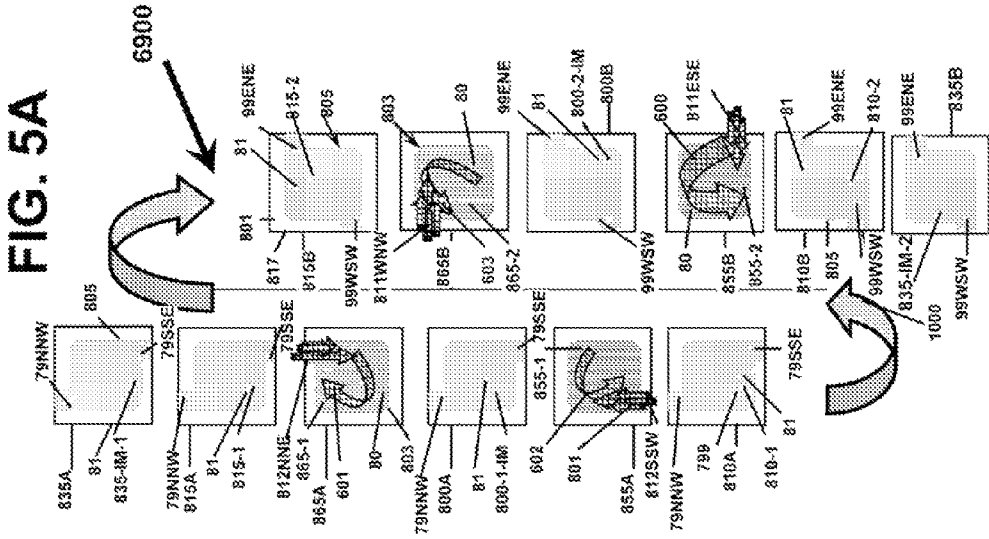
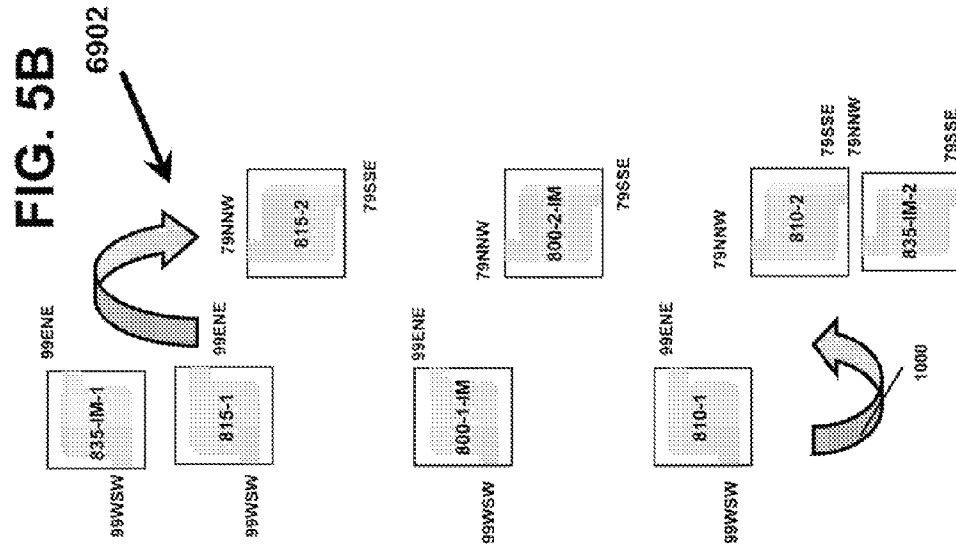

FIG. 5C

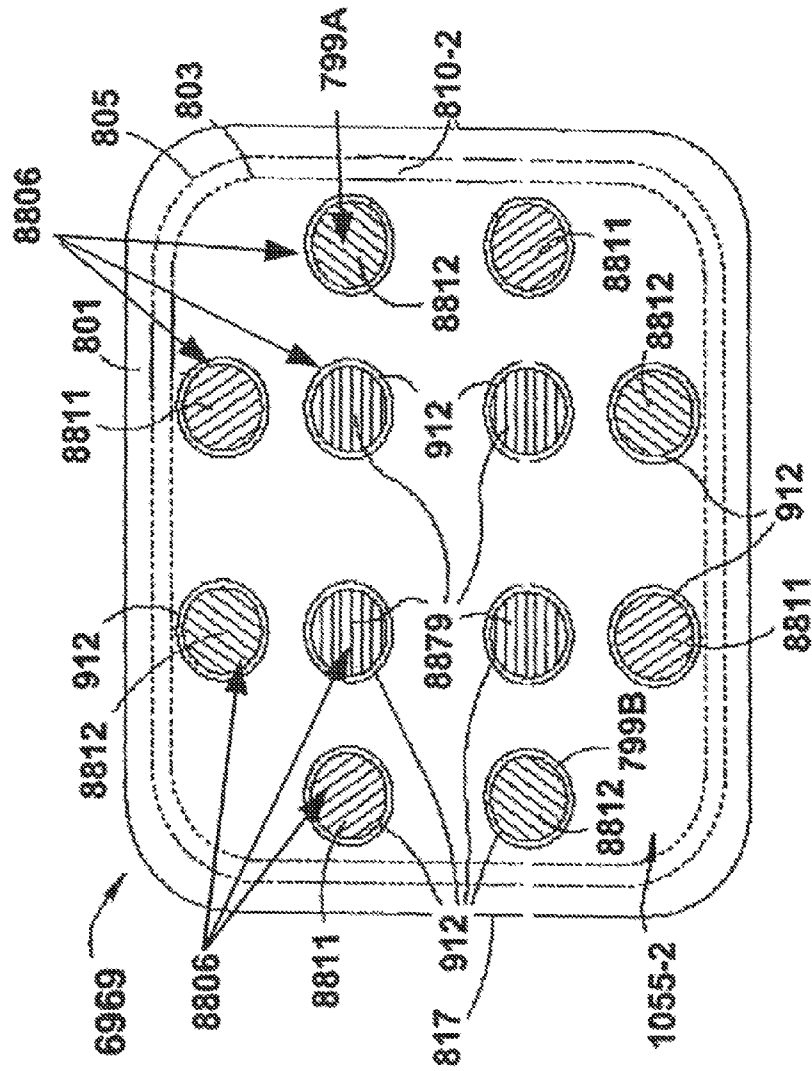

FIG. 6

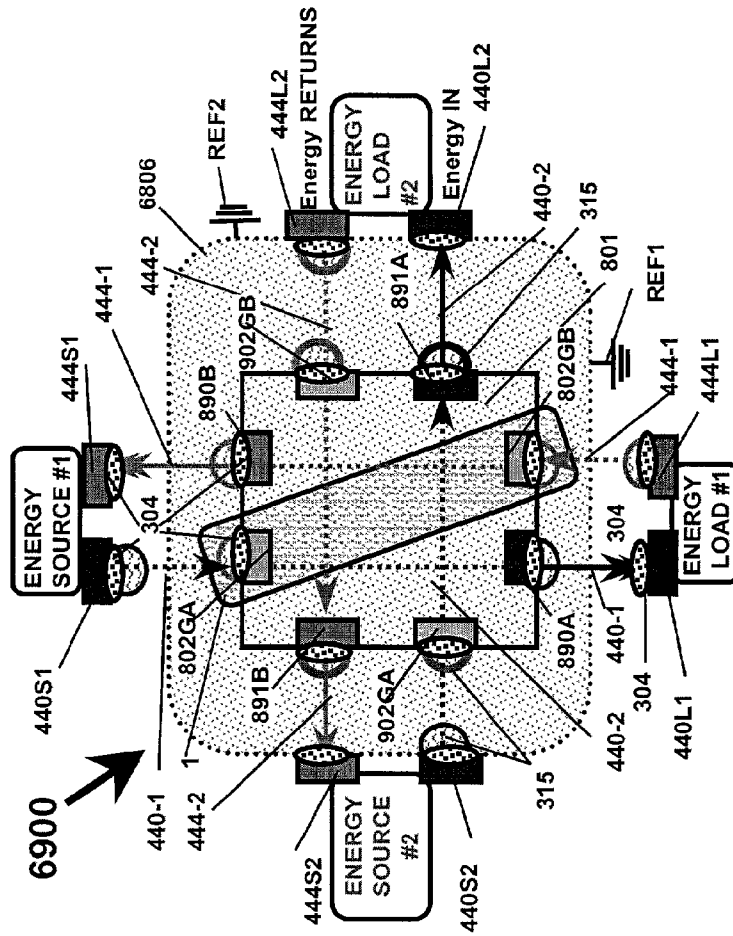
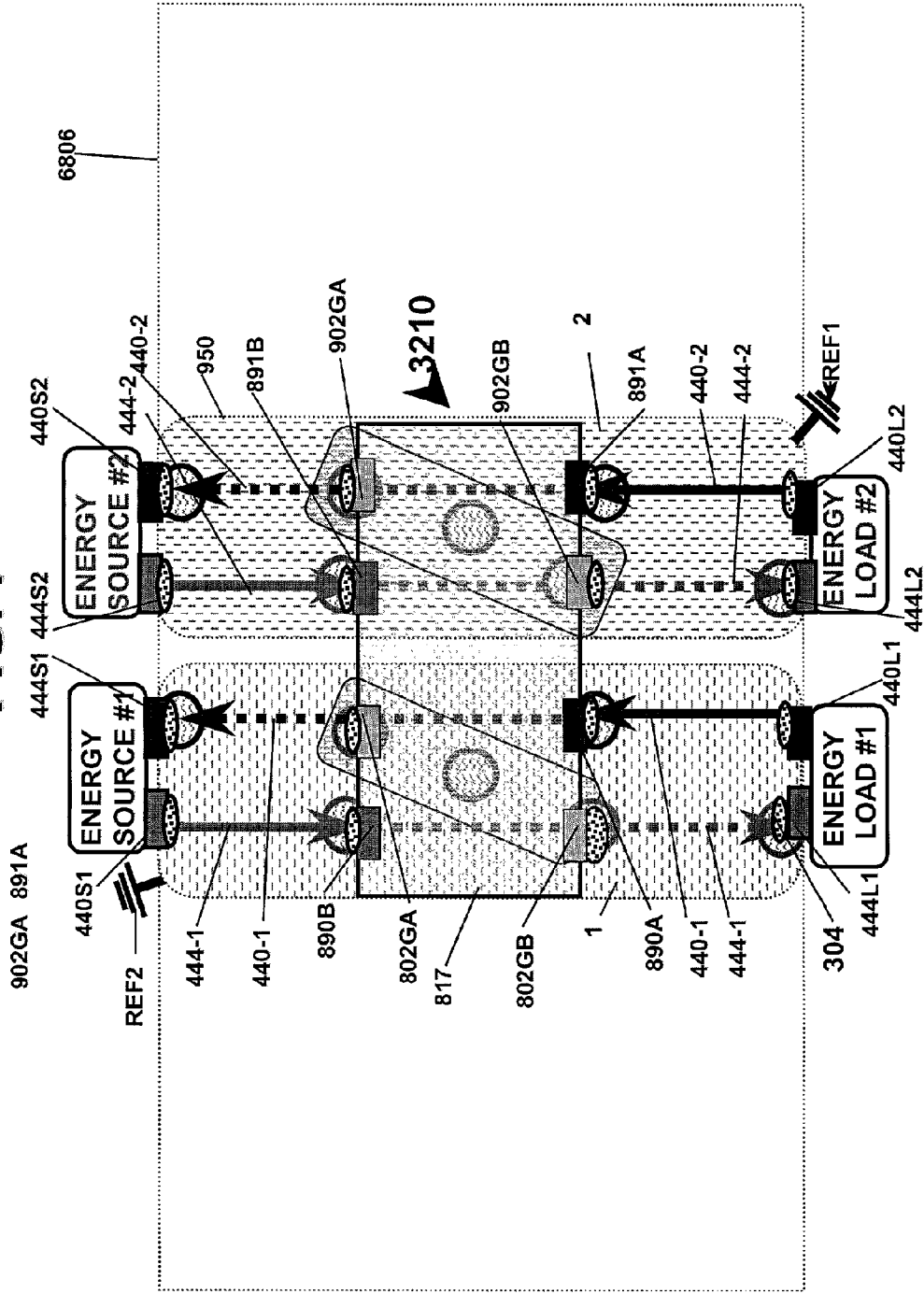

FIG. 7



ARRANGEMENT FOR ENERGY CONDITIONING

CROSS REFERENCE TO RELATED APPLICATIONS

This application is a continuation of application Ser. No. 12/554,976, filed Sep. 7, 2009 now U.S. Pat. No. 7,768,763, which is a continuation of application Ser. No. 11/866,437, filed Oct. 3, 2007, now abandoned, which is a continuation of application Ser. No. 11/296,391, filed Dec. 8, 2005, now issued as U.S. Pat. No. 7,321,485, which is a continuation of application Ser. No. 10/189,339, filed Jul. 2, 2002, now issued as U.S. Pat. No. 7,110,235, which is a continuation-in-part of application Ser. No. 10/115,159, filed Apr. 2, 2002, now issued as U.S. Pat. No. 6,894,884, which is a continuation-in-part of application Ser. No. 09/845,680, filed Apr. 30, 2001, now issued as U.S. Pat. No. 6,580,595, which is a continuation-in-part of application Ser. No. 09/777,021, filed Feb. 5, 2001, now issued as U.S. Pat. No. 6,687,108, which is a continuation-in-part of application Ser. No. 09/632,048, filed Aug. 3, 2000, now issued as U.S. Pat. No. 6,738,249, which is a continuation-in-part of application Ser. No. 09/594,447, filed Jun. 15, 2000, now issued as U.S. Pat. No. 6,636,406, which is a continuation-in-part of application Ser. No. 09/579,606, filed May 26, 2000, now issued as U.S. Pat. No. 6,373,673, which is a continuation-in-part of application Ser. No. 09/460,218, filed Dec. 13, 1999, now issued as U.S. Pat. No. 6,331,926, which is a continuation of application Ser. No. 09/056,379, filed Apr. 7, 1998, now issued as U.S. Pat. No. 6,018,448, which is a continuation-in-part of application Ser. No. 09/008,769, filed Jan. 19, 1998, now issued as U.S. Pat. No. 6,097,581, which is a continuation-in-part of application Ser. No. 08/841,940, filed Apr. 8, 1997, now issued as U.S. Pat. No. 5,909,350;

and application Ser. No. 10/115,159, filed Apr. 2, 2002, now issued as U.S. Pat. No. 6,894,884, also claims the benefit of provisional Application No. 60/280,819, filed Apr. 2, 2001, and provisional Application No. 60/302,429, filed Jul. 2, 2001 and provisional Application No. 60/310,962, filed Aug. 8, 2001;

and application Ser. No. 10/189,339, filed Jul. 2, 2002, now issued as U.S. Pat. No. 7,110,235, also claims the benefit of provisional Application No. 60/302,429, filed Jul. 2, 2001, and provisional Application No. 60/310,962, filed Aug. 8, 2001, and provisional Application No. 60/349,954, filed Jan. 18, 2002, and provisional Application No. 60/388,388 filed Jun. 12, 2002.

This application incorporates by reference the teachings of application Ser. No. 12/554,976, filed Sep. 7, 2009, application Ser. No. 11/866,437, filed Oct. 3, 2007, now abandoned, application Ser. No. 11/296,391, filed Dec. 8, 2005, now issued as U.S. Pat. No. 7,321,485, application Ser. No. 10/115,159, filed Apr. 2, 2002, now issued as U.S. Pat. No. 6,894,884, application Ser. No. 09/845,680, filed Apr. 30, 2001, now issued as U.S. Pat. No. 6,580,595, application Ser. No. 09/777,021, filed Feb. 5, 2001, now issued as U.S. Pat. No. 6,687,108, application Ser. No. 09/594,447, filed Jun. 15, 2000, now issued as U.S. Pat. No. 6,636,406, application Ser. No. 09/579,606, filed May 26, 2000, now issued as U.S. Pat. No. 6,373,673, application Ser. No. 09/460,218, filed Dec. 13, 1999, now issued as U.S. Pat. No. 6,331,926, application Ser. No. 09/056,379, filed Apr. 7, 1998, now issued as U.S. Pat. No. 6,018,448, application Ser. No. 09/008,769, filed Jan. 19, 1998, now issued as U.S. Pat. No. 6,097,581, and application Ser. No. 08/841,940 filed Apr. 8, 1997, now issued as U.S. Pat. No. 5,909,350.

TECHNICAL FIELD

This application relates to balanced shielding arrangements that use complementary relative groupings of energy pathways, such as pathways for various energy propagations for multiple energy conditioning functions. These shielding arrangements may be operable as discrete or non-discrete embodiments that can sustain and condition electrically complementary energy confluences.

BACKGROUND

Today, as the density of electronics within applications increases, unwanted noise byproducts of the increased density may limit the performance electronic circuitry. Consequently, the avoidance of the effects of unwanted noise byproducts, such as by isolation or immunization of circuits against the effects of the undesirable noise is an important consideration for circuit arrangements and circuit design.

Differential and common mode noise energy may be generated by, and may propagate along or around, energy pathways, cables, circuit board tracks or traces, high-speed transmission lines, and/or bus line pathways. These energy conductors may act as, for example, an antenna that radiates energy fields. This antenna-analogous performance may exacerbate the noise problem in that, at higher frequencies, propagating energy utilizing prior art passive devices may experience increased levels of energy parasitic interference, such as various capacitive and/or inductive parasitics.

These increases may be due, in part, to the combination of constraints resulting from functionally or structurally limitations of prior art solutions, coupled with the inherent manufacturing or design imbalances and performance deficiencies of the prior art. These deficiencies inherently create, or induce, unwanted and unbalanced interference energy that may couple into associated electrical circuitry, thereby making at least partial shielding from these parasitics and electromagnetic interference desirable. Consequently, for broad frequency operating environments, solving these problems necessitates at least a combination of simultaneous filtration, careful systems layout having various grounding or anti-noise arrangements, as well as extensive isolating in combination with at least partial electrostatic and electromagnetic shielding.

Thus, a need exists for a self-contained, energy-conditioning arrangement utilizing simplified energy pathway arrangements, which may additionally include other elements, amalgamated into a discrete or non-discrete component, which may be utilized in almost any circuit application for providing effective, symmetrically balanced, and sustainable, simultaneous energy conditioning functions selected from at least a decoupling function, transient suppression function, noise cancellation function, energy blocking function, and energy suppression functions.

BRIEF DESCRIPTION OF THE DRAWINGS

Understanding of the present invention will be facilitated by consideration of the following detailed description of the preferred embodiments of the present invention taken in conjunction with the accompanying drawings, in which like numerals refer to like parts and in which:

FIG. 1 is a relative location compass operable for determining relative locations of the various pathway extensions disclosed;

FIGS. 1A-1C show relative locations of the various pathway extensions disclosed according to an aspect of the present invention;

FIG. 2A shows a circuit schematic of the plan view of an embodiment of 2B according to an aspect of the present invention;

FIG. 2B is a plan view of an embodiment according to an aspect of the present invention;

FIG. 3A shows a circuit schematic of the plan view of an embodiment of 3B according to an aspect of the present invention;

FIG. 3B is a plan view of an embodiment according to an aspect of the present invention;

FIG. 3C shows a plan view of a shield according to an aspect of the present invention;

FIG. 4A shows a relative plan view of an embodiment according to an aspect of the present invention;

FIG. 4B shows a relative plan view of an embodiment according to an aspect of the present invention;

FIG. 4C shows a relative plan view of an embodiment according to an aspect of the present invention;

FIG. 4D shows a relative plan view of an embodiment according to an aspect of the present invention;

FIG. 4E shows a relative plan view of an embodiment according to an aspect of the present invention;

FIG. 4F shows a relative plan view of an embodiment according to an aspect of the present invention;

FIG. 4G shows a relative plan view of an embodiment according to an aspect of the present invention;

FIG. 4H shows a relative plan view of an embodiment according to an aspect of the present invention;

FIG. 4I shows a relative plan view of an embodiment according to an aspect of the present invention;

FIG. 5A shows a stacked multiple, circuit network including groups of pathways according to an aspect of the present invention;

FIG. 5B shows a stacked shield according to an aspect of the present invention;

FIG. 5C shows a relative plan view of a stacked multiple, non-shared circuit network having VIAs including groups of pathways according to an aspect of the present invention;

FIG. 6 shows a relative plan view of circuit arrangement variant according to an aspect of the present invention; and,

FIG. 7 shows a relative plan view of circuit arrangement variant according to an aspect of the present invention.

DETAILED DESCRIPTION

This application incorporates by reference herein each of the following: application Ser. No. 10/115,159, filed Apr. 2, 2002, now issued as U.S. Pat. No. 6,894,884, which is a continuation-in-part of co-pending application Ser. No. 09/845,680, filed Apr. 30, 2001, now issued as U.S. Pat. No. 6,580,595, which is a continuation-in-part of co-pending application Ser. No. 09/815,246 filed Mar. 22, 2001, now issued as U.S. Pat. No. 6,469,595, which is a continuation-in-part of co-pending application Ser. No. 09/777,021 filed Feb. 5, 2001, now issued as U.S. Pat. No. 6,687,108, which is a continuation-in-part of co-pending application Ser. No. 09/632,048, filed Aug. 3, 2000, now issued as U.S. Pat. No. 6,738,249, which is a continuation-in-part of co-pending application Ser. No. 09/594,447, filed Jun. 15, 2000, now issued as U.S. Pat. No. 6,636,406, which is a continuation-in-part of co-pending application Ser. No. 09/579,606 filed May 26, 2000, now issued as U.S. Pat. No. 6,373,673, which is a continuation-in-part of co-pending application Ser. No. 09/460,218, filed Dec. 13, 1999, now issued as U.S. Pat. No.

6,331,926, which is a continuation of application Ser. No. 09/056,379, filed Apr. 7, 1998, now issued as U.S. Pat. No. 6,018,448, which is a continuation-in-part of application Ser. No. 09/008,769, filed Jan. 19, 1998, now issued as U.S. Pat. No. 6,097,581, which is a continuation-in-part of application Ser. No. 08/841,940, filed Apr. 8, 1997, now issued as U.S. Pat. No. 5,909,350.

In addition, this application incorporates by reference herein each of the following: provisional Application No. 60/302,429, filed Jul. 2, 2001, provisional Application No. 60/310,962, filed Aug. 8, 2001, provisional Application No. 60/349,954, filed Jan. 8, 2002 and provisional Application No. 60/388,388, filed Jun. 12, 2002.

It is to be understood that the figures and descriptions of the present invention have been simplified to illustrate elements that are relevant for a clear understanding of the present invention, while eliminating, for the purpose of clarity, many other elements found in typical energy conditioning systems and methods. Those of ordinary skill in the art will recognize that other elements and/or steps are desirable and/or required in implementing the present invention. However, because such elements and steps are well known in the art, and because they do not facilitate a better understanding of the present invention, a discussion of such elements and steps is not provided herein. The disclosure herein is directed to all such variations and modifications to such elements and methods known to those skilled in the art. Additionally, it will be apparent to those skilled in the art that terms used herein that may include a whole, or a portion of a whole, such as “energy”, “system”, circuit, and the like, are contemplated to include both the portions of the whole, and the entire of the whole, as used, unless otherwise noted.

As used herein, an “energy pathway” or “pathway” may be at least one, or a number, of conductive materials, each one operable for sustained propagation of energy. Pathways may be conductive, thereby better propagating various electrical energies as compared to non-conductive or semi-conductive materials directly or indirectly coupled to, or adjacent to, the pathways. An energy pathway may facilitate propagation of a first energy by allowing for various energy conditioning functions, such as conditioning functions arising due to any one or a number of aspects, such as, but not limited to, the shielding, the orientation and/or the positioning of the energy pathways within the energy pathway arrangement, which various arrangements having an orientation and/or positioning thereby allow for interaction of the first energy with propagating energies that are complementary to at least the first energy. An energy pathway may include an energy pathway portion, an entire energy pathway, a conductor, an energy conductor, an electrode, at least one process-created conductor, and/or a shield. A plurality of energy pathways may include a plurality of each device or element discussed hereinabove with respect to energy pathway. Further, as used generally herein, a conductor may include, for example, an individual conductive material portion, a conductive plane, a conductive pathway, a pathway, an electrical wire, a via, an aperture, a conductive portion such as a resistive lead, a conductive material portion, or an electrical plate, such as plates separated by at least one medium 801, for example.

A shield may include a shielding electrode, a shielding pathway portion, a shielded pathway, a shielded conductor, a shielded energy conductor, a shielded electrode, and/or at least one process-created shielded pathway portion. A plurality of shields may include a plurality of the devices discussed hereinabove with respect to a shield.

As used generally herein, a pathway may be complementary positioned, or complementary orientated, with respect to

a main-body **80**, **81**, having various pathway extensions, designated **79**“X”, **812**“X”, **811**“X” and **99**“X”. Main-bodies **80**, **81** may be in three-dimensional physical relationships individually, in pairs, groups, and/or pluralities as to distance, orientation, position, superposition, non-superposition, alignment, partial alignment, lapping, non-lapping, and partial lapping. Superposed main-body pathway **80**, may, for example include a pairing of physically opposing and oppositely orientated main-body pathways **80** that are any one of, or any combination of, electrically null, electrically complementary, electrically differential, or electrically opposite.

A pathway arrangement may include at least a shield at least partially shielding at least one energy pathway, or a group of shields forming a shield structure that at least partially shielding, via a conductive shielding, at least a conductively isolated pairing of at least two energy pathways, such as vias, apertures or complementary paired pathways.

An exemplary embodiment may allow energy propagation on a conductively isolated pairing, such as complementary paired pathways, causing energy propagation on common shields, or at least one grouping of shields, serving an isolated circuit. This embodiment may allow a low inductance pathway to form among at least a single pair of isolated and separate parallel pathways serving at least one separate and distinct isolated circuit system. An exemplary embodiment may allow for the development of at least a low inductance pathway for utilization of energy propagating on at least one parallel pathway of at least two sets of isolated and separate parallel pathways and the development along at least one parallel pathway of at least one other low inductance pathway for utilization of energy propagating along at least one other separate and distinct isolated circuit system.

An exemplary embodiment utilized as part of a circuit assembly may have at least one pathway of relatively lower inductance, while other pathways may be electrically coupled to an energy source or an energy load. A pathway of a second plurality of pathways may have a lower impedance operable for portions of energy to be taken away from either of the same at least one energy source or at least one energy load of the circuit assembly. This same pathway of low impedance may not be electrically directly coupled to either the same at least one energy source or at least one energy load of the circuit assembly as the one pathway of lower inductance. A system may have both a pathway of least inductance and a pathway of least impedance which are not the same pathway.

In contrast to capacitors found in the industry wherein an equivalent series inductance (ESL) of a capacitor device is normally size dependant, in the present invention the pathway of least impedance and the pathway of least inductance for a circuit for energy conditioning may be achieved independent of the physical size of the device. These aspects depend on a predetermined capacitance developed by a predetermined layers in the present invention.

Arranging the pathways allows the resistance of the conductive material of the pathways to primarily determine the energy delivery, or relative efficiency or effect between at least one source of energy and one energy utilizing load of an integrated circuit, for example. The ESL may be a negligible factor, rather than a primary factor for delivery outcome or decoupling void of debilitating inductances.

In an illustrative pathway arrangement illustrated in FIGS. **1A**, **1B**, **1C**, **5A** and **5B**, wherein the various propagating energies may be complementary, the pathway arrangement, upon placement into a circuit arrangement, may allow for energy propagation within or along certain energy pathways of the pathway arrangement, thereby allowing for the mutual interaction of opposite portions of pathway-sourced magnetic

fields produced by the propagation of energy field currents emanating outwardly from each set of the complementary conductors. This mutual interaction may be a mutual cancellation in embodiments wherein certain pathways may be partially or totally physically shielded from other complementary pathways, and may be placed within an influencing distance of those other complementary pathways. Further, a substantial similarity in size and shape of the respective complementary pathways, including the spaced-apart relationship and the interpositioning of a shielding between pathways, and the conductively isolated relationship of the pathways, may contribute to this mutual cancellation effect. Additionally, the shielding operations may be predicated on a relative positioning of a mating of the paired pathways relative to the conductive electrostatic shielding. At least the complementary energy conditioning functions and electrostatic shielding dynamics discussed herein may operate on various energy propagating in various directions along various predetermined pathways, and may operate on circuits having dynamic operation utilizing the pathway arrangement.

A sub-combination of electromagnetically/electrostatically actuated impedance states may develop along or within a pathway arrangement, or along or within a closely coupled external conductive portion conductively coupled to separate or multiple groupings of shields, to thereby form an energy conditioning circuit. These electromagnetically/electrostatically actuated impedance states may develop, for example, because of the energization of one paired set of pathways of one circuit portion, but not necessarily develop on another paired set of pathways from another circuit portion, for example.

According to an aspect of the present invention, each shield may include a main-body **81**. Main-bodies **81** may collectively and conductively couple to one another and at the same time may substantially immerse and shield the main-body **80** of the energy pathways. In other embodiments of the present invention, the collective shielding main-body **81** may only partially immerse or shield the pathway main-body **80**s in at least one portion of the shielding.

According to an aspect of the present invention, a balanced, symmetrical, pathway arrangement may result from the symmetry of certain superposed shields, from complementary pathway sizing and shaping, and/or from reciprocal positioning and pairing of the complementary pathways. Manufacturable balanced or symmetrical physical arrangements of pathways, wherein dynamic energy propagation, interactions, pairings or match-ups of various dynamic quantities occur, may operate at less than a fundamental limit of accuracy of testing equipment. Thus, when portions of these complementary energy quantities interact simultaneously, the energy may be beyond the quantifiable range of the typical testing equipment. Thus, the extent to which the measurement may be obtained may employ increased controllability, and thereby the electrical characteristics and the effect on electrical characteristics may be controlled, such as by predetermining the desired measurability, behavior or enhancement to be provided, and by a correspondent arrangement of the elements, such as specifically by an arrangement of the elements to provide the desired measurability or effect. For example, a desired electrical characteristic may be predetermined for a desired enhancement by varying at least a portion of the complementary balance, size, shape, and symmetry of at least one pathway pairing, as set forth herein below and as illustrated in FIGS. **1A**, **1B**, **1C**, **5A** and **5B**, for example.

Thus, the extent of energy interactions, mutual energy propagation timings and interferences, for example, may be controlled by tolerances within the pathway arrangement. A

manufacturing process, or computer tolerance control, such as semiconductor process control, may control these tolerances, for example. Thus, the pathways of an embodiment may be formed using manufacturing processes, such as passive device processes, apparent to those skilled in the art. Mutual energy propagation measurements may thereby be cancelled or suppressed by the formation, and process of formation, of the pathway arrangement.

A pathway arrangement may, as set forth hereinabove, include a sequentially positioned grouping of pathways in an amalgamated electronic structure having balanced groupings of pathways. The balanced grouping may include a predetermined pathway architecture having a stacked hierarchy of pathways that are symmetrical and complementary in number, and that are positioned complementary to one another, thereby forming pairs, each of which pair is substantially equidistant from each side of a centrally positioned shield, wherein each shield may provide a symmetrical balancing point for both each pair pathway and the overall pathway hierarchy as depicted in FIGS. 1A to 4I, for example. Thus, predetermined identically sized, shaped and complementary positioned pathways may be present on either side of a centrally positioned shield for each separate circuit portion. A total circuit may have its complementary portions symmetrically divided into a complementary physical format including a reverse-mirror image positioning of paired shielded, complementary sized and shaped pathways, sandwiching at least one interposing shield.

According to an aspect of the present invention, each pathway may be, for example, a first interconnect substrate wrapping around, or holding, an integrated circuit wafer, a deposit, an etching, or a resultant of a doping process, and the shield may be, for example, a pathway substrate, an energy conditioning embodiment or energy conditioning substrate, a deposit, an etching, a resultant of a doping process, and may have, for example, resistive properties. Additional elements may be utilized, including conductive and nonconductive elements, between the various pathways. These additional elements may take the form of ferromagnetic materials or ferromagnetic-like dielectric layers, and/or inductive-ferrite dielectric derivative materials. Additional pathway structural elements may be utilized, including conductive and nonconductive multiple pathways of different conductive material compositions, conductive magnetic field-influencing material hybrids and conductive polymer sheets, various processed conductive and nonconductive laminates, straight conductive deposits, multiple shielding pathways utilizing various types of magnetic material shields and selective shielding, and conductively doped and conductively deposited on the materials and termination solder, for example, in addition to various combinations of material and structural elements, to provide a host of energy conditioning options.

Non-conductor materials may also provide structural support of the various pathways, and these non-conductor materials may aid the overall energized circuit in maintaining the simultaneous, constant and uninterrupted energy propagation moving along the pathways. Dielectric materials for example, may include one or more layers of material elements compatible with available processing technology. These dielectric materials may be a semiconductor material such as silicon, germanium, gallium arsenide, or a semi-insulating and insulating material such as, but not limited to any K, high K and low K dielectrics.

Pathway and conductor materials may be selected from a group consisting of Ag, Ag/Pd, Cu, Ni, Pt, Au, Pd and other such conductive materials and metals. Combinations of these metal materials are suitable for the purposes discussed herein,

and may include appropriate metal oxides, such as ruthenium oxide, which, depending on the exigencies of a particular application, may be diluted with a suitable metal. Other pathways may be formed of a substantially non-resistive conductive material. Any substances and processes that may create pathways from conductive, non-conductive, semi-conductive material, and/or Mylar films printed circuit board materials, or any substances or processes that may create conductive areas such as doped polysilicons, sintered polycrystallines, metals, polysilicon silicates, or polysilicon silicide may be used within or with the pathway arrangement.

An exemplary embodiment of the present invention may utilize an internal shield structural architecture to insure energy balancing configurations within the various arrangements, rather than a specific external circuit balance. This balancing configuration is dependent upon the relative positioning of all the shields in relationship to the shared and centrally positioned shield, and the actual paired shields positioned in specific quantities, to simultaneously provide shielding for the electrically opposing shielded paired pathways utilized by propagating energy. This allows these electrically opposing complementary pathways to be located both electrically and physically on the opposite sides of the centrally positioned and shared common conductive shield. This interposition of the central and shared shields may create a voltage divider that divides various circuit voltages in half and that provides, to each of the oppositely paired shielded conductors, one half of the voltage energy normally expected. The energized circuitry, including shielded conductors, may be balanced electrically or in a charge-opposing manner and with respect to a centrally positioned shield, to a common and shared pathway, or to each respective, isolated circuit system portion. Each common circuit member of an isolated circuit system may be attached or coupled to a common area or common pathway, thereby providing an external common zero voltage. Thus, the embodiment may have multiple sets of shields electrically or physically located between at least one of the various electrically or charge opposing, shielded pairs or grouped complementary pairs of pathways in an interposed shielding relationship, supported with additional outer sandwiching shields, designated herein as -IM that are additionally coupled and, in part, form the shielding structure.

An exemplary embodiment may also be placed into one or more energy circuits that utilize different energy sources and that may supply one or more separate and distinct energy-utilizing loads. When energized for multiple energy conditioning operations and for providing simultaneous and effective energy conditioning functions, such as electromagnetic interference filtering, suppression, energy decoupling and energy surge protection, each separate and distinct circuit is utilizing the multiple commonly shared universal shield structure and circuit reference image, or node.

According to an aspect of the present invention, energy-conditioning functions may maintain an apparent balanced energy voltage reference and energy supply for each respective energy-utilizing load within a circuit. This energized arrangement may allow for specific energy propagation utilizing a single, or multiple, isolated pathway arrangement, and may not require balancing on a single, centralized shield. A shield may be physically and electrically located between one or multiple energy sources and one or multiple energy utilizing loads, depending upon the number of separate and isolated pathways. Thus shielding relative, centralized pathways may be in both co-planar and stacked variants of exemplary embodiment.

When the internally positioned paired shielded pathways are subsequently attached, or conductively coupled, to exter-

nally manufactured pathways, the internally positioned paired shields may be substantially enveloped within the cage-like shield structure, thereby minimizing internally generated energy strays and parasitics that may normally escape or couple to an adjacent shielded pathway. These shielding modes utilize propagating energy to the various pathways and may be separate of the electrostatic shield effect created by the energization of the shield structure. The propagating energy propagating in a complementary manner provides energy fields of mutually opposed, mutually cancelled fields as a result of the close proximity of opposite propagation. The complementary and paired pathways may provide an internally balanced opposing resistance load function.

A device according to an aspect of the present invention may mimic the functionality of at least one electrostatically shielded transformer. Transformers may be widely used to provide common mode isolation dependent upon a differential mode transfer across the inputs in order to magnetically link the primary windings to the secondary windings to transfer energy. As a result, common mode voltage across the primary winding is rejected. One flaw inherent in the manufacturing of transformers is the propagating energy source capacitance between the primary and secondary windings. As the frequency of the circuit increases, so does capacitive coupling, until circuit isolation may be compromised. If enough parasitic capacitance exists, high frequency RF energy may pass through the transformer and cause an upset in the circuits on the other side of the isolation gap subjected to the transient event. A shield may be provided between the primary and secondary windings by coupling to a common pathway reference source designed to prevent capacitive coupling between the multiple sets of windings. A device according to an aspect of the present invention improves upon, and reduces the need for, transformers in circuits. The device may use a physical and relative, common pathway shield to suppress parasitics and also may use relative positioning of common pathway shields, a complementary paired pathway layering, the various couplings of the pathway layering, and an external conductive coupling to a conductive area per isolated circuit system, in combination with the various external circuitry, to effectively function as a transformer. If an isolated circuit system is upset by transients, the electrostatically shielded, transformer function of the device discussed herein may be effective for transient suppression and protection, and may simultaneously operate as a combined differential mode and common mode filter. Each set of relative shields and relative conductors may be conductively coupled to at least the same external pathway to provide a transformer functionality for example.

Propagated electromagnetic interference may be the product of both electric and magnetic fields. A device according to an aspect of the present invention may be capable of conditioning energy that uses DC, AC, and AC/DC hybrid-type propagation, including conditioning energy in systems that may contain different types of energy propagation formats and in systems that may contain more than one circuit propagation characteristic.

In an exemplary embodiment, perimeter conductive coupling material for coupling or connecting, by conductive joining, of external portions of a typical embodiment into an assembly may be accomplished by conductive or non-conductive attachments to various types of angled, parallel or perpendicular, as those terms apply relative to at least another pathway, conductors known as apertures or blind or non-blind VIAs, passing through, or almost through, portions respectively of an exemplary embodiment. Couplings to at least one or more load(s), such as a portion of an integrated circuit, for

one aspect of the invention may involve a selective coupling, or not, to these various types of conductors, such as apertures and VIAs.

Fabricating a pathway may include forming one or more plated through hole (PTH) via(s) through one or more levels of a pathway. Electronic packages commonly include multiple interconnect levels. In such a package, the invention may include layerings of patterned conductive material on one interconnect level that may be electrically insulated from patterned conductive material on another interconnect level, such as by dielectric material layers.

Connections or couplings between the conductive material at the various interconnect levels may be made by forming openings, referred to herein as vias or apertures, in the insulating portions or layers, that in turn can provide an electrically conductive structure such that the patterned or shaped conductive material portions or pathways from different levels are brought into electrical contact with each other. These structures can extend through one or more of the interconnect levels. Use of conductive, non-conductive or conductively-filled apertures and VIAs allows propagating energy to transverse an exemplary embodiment as if utilizing a by-pass or feed-through pathway configuration of an embodiment. An embodiment may serve as a support, a system or a subsystem platform that may contain both or either active and passive components layered to provide the benefits described for conditioning propagated energy between at least one source and at least one load.

An aspect of the present invention may provide a conductive architecture or structure suitable for inclusion in a packaging or an integrated circuit package having other elements. Other elements may be directly coupled to the device for simultaneous physical and electrical shielding by allowing simultaneous energy interactions to take place between grouped and energized complementary conductors that are fed by other pathways. Typical capacitive balances found between at least one shielding pathway may be found when measuring opposite sides of the shared shield structure per isolated circuit, and may be maintained at measured capacitive levels within this isolated circuit portion, even with the use of common non-specialized dielectrics or pathway conductive materials. Thus, complementary capacitive balancing, or tolerance balancing characteristics, of this type of electrical circuit due to element positioning, size, separations and attachment positioning allow an exemplary embodiment having an isolated circuit system manufactured at 3% capacitive tolerance, internally, to pass to a conductively coupled and energized isolated circuit system a maintained and correlated 3% capacitive tolerance between electrically opposing and paired complementary pathways of each respective isolated circuit system, with respect to the dividing shield structures placed into the isolated circuit system.

An exemplary embodiment may allow utilization of relatively inexpensive dielectrics, conductive materials and various other material elements in a wide variety of ways. Due to the nature of the architecture, the physical and electrical dividing structure created may allow the voltage dividing and balancing among the grouped, adjacent elements, and may allow for the minimization of the effect of material hysteresis and piezoelectric phenomenon to such a degree that propagating energy normally disrupted or lost to these effects may be essentially retained in the form of active component switching response time, as well as instantaneous ability to appear to the various energy-utilizing loads as an apparent open energy flow simultaneously on both electrical sides of a pathway connecting or coupling from an energy source to a respective load, and from the load back to the source.

A structured layer may be shaped, buried within, enveloped by, or inserted into various electrical systems and sub-systems to perform line conditioning or decoupling, for example, and to aid in or to allow for a modifying of an electrical transmission of energy to a desired or predetermined electrical characteristic. Expensive, specialized, dielectric materials that attempt to maintain specific or narrow energy conditioning or voltage balancing may no longer be needed for bypass, feed through, or energy decoupling operations for a circuit.

A device according to an aspect of the present invention may, as set forth hereinabove, be placed between each isolated circuit and a paired plurality of pathways or differential pathways. This exemplary device may operate effectively across a broad frequency range, as compared to a single discrete capacitor or inductor component, and may continue to perform effectively within an isolated circuit system operating beyond, for example, a GHz.

As set forth hereinabove, the exemplary device may perform shielding functions in this broad frequency range. A physical shielding of paired, electrically opposing and adjacent complementary pathways may result from the size of the common pathways in relationship to the size of the complementary pathways, and from the energized, electrostatic suppression or minimization of parasitics originating from the sandwiched complementary conductors and preventing external parasitics. Further, the positioning of the shielding, relative to shielding that is more conductive, may be used to protect against inductive energy and "H-Field" coupling. This technique is known as mutual inductive cancellation.

Parasitic coupling is known as electric field coupling. The shielding function discussed hereinabove provides primary shielding of the various shielded pathways electrostatically against electric field parasitics. Parasitic coupling involving the passage of interfering propagating energy because of mutual or stray parasitic energy originating from the complementary conductor pathways may be thereby suppressed. A device according to an aspect of the present invention may, for example, block capacitive coupling by enveloping oppositely phased conductors in the universal shield architecture with stacked conductive hierarchical progression, thereby providing an electrostatic or Faraday shield effect with respect to the pathway positioning as to the respective layering and position, both vertically and horizontally, of the pathways. The shielding pathway architecture may be used to suppress and prevent internal and external parasitic coupling between potentially noisy conductors and victim conductors, such as by an imposition of a number of common pathway layers that are larger than the smaller paired complementary pathways, but that are positioned between each of the complementary pathway conductor pairs to suppress and to contain the stray parasitics.

Further, as set forth hereinabove, positioning of the shielding, relative to shielding that is more conductive, may be used against inductive energy and "H-Field" coupling. This cancellation is accomplished by physically shielding energy, while simultaneously using a complementary and paired pathway positioned to allow for the inseting of the contained and paired complementary pathways within an area size correspondent to the shield size. A device according to an aspect of the present invention is adapted to use shields separately as internal shields or groupings, thereby substantially isolating and sandwiching pairs of electrically opposing complementary pathways, and thereby providing a physically tight or minimized energy and circuit loop propagation path between each shield and the active load. Close proximity of shields and

non-shields may allow energy along shields even if a direct electrical isolation exists because of material type or the spacing.

Flux cancellation of propagating energy along paired and electrically opposing or differential pathways may result from spacing of pathways apart by a very small distance for oppositely phased electrically complementary operations, thereby resulting in a simultaneous stray parasitic suppression and containment function attributable to tandem shielding, and thereby enhancing energy conditioning.

In attaining minimum areas for various current loops in an isolated circuit system, additional shielding energy currents may be distributed around component shielding architectures. A plurality of shields as described hereinabove may be electrically coupled as either an isolated circuit's reference node, or chassis ground, and may be relied on as a commonly used reference pathway for a circuit. Thus, the various groups of internally paired, complementary pathways may include propagating energy originating from one or more energy sources propagating along external pathways coupled to the circuit by a conductive material. Energy may thus enter the device, undergo conditioning, and continue to each respective load.

The shielding structure may allow for a portion of a shield to operate as the pathway of low impedance for dumping and suppressing, as well as at least partially blocking return of unwanted electromagnetic interference noise and energy into each of the respective energized circuits. In an embodiment, internally located shields may be conductively coupled to a conductive area, thereby adaptively utilizing shielding structure for low impedance dumping and suppressing and at least partially blocking return blocking of unwanted electromagnetic interference noise and energy. Additionally, another set of internally located shields may be conductively coupled to a second conductive area, thereby utilizing shields for low impedance dumping, suppressing and at least partially blocking the return of unwanted electromagnetic interference noise and energy. The conductive areas may be electrically or conductively isolated from one another.

Simultaneous suppression of energy parasitics may be attributed to the enveloping shielding pathway structure, in combination with the cancellation of mutually opposing energy fields, and may be further attributed to the electrically opposing shielded pathways and propagating energy along the various circuit pathways interacting within the various isolated circuits to undergo a conditioning effect taking place upon the propagating energy. This conditioning may include minimizing effects of H-field energy and E-field energy through simultaneous functions, such as through isolated circuits that contain and maintain a defined electrical area adjacent to dynamic simultaneous low and high impedance pathways of shielding in which various paired pathways have their respective potentials respectively switching as a result of a given potential located on a shielding and used instantaneously and oppositely by these pairings with respect to the utilization by energy found along paired routings of the low and high impedance shields.

The various distance relationships created by the positional overlapping of energy routings within the isolated circuits combine with the various dynamic energy movements to enhance and cancel the various degrees of detrimental energy disruptions normally occurring within active components or loads. The efficient energy conditioning functions occurring within the passive layering architecture allow for development of a dynamic "0" impedance energy "black hole", or energy drain, along a third pathway coupled common to both complementary pathways and adapted to allow energy to be

contained and dissipated upon the shielding, within the various isolated circuits and attached or conductively coupled circuits. Thus, electrically opposing energies may be separated by dielectric material and/or by an interposition shield structure, thereby allowing dynamic and close distance relationship within a specific circuit architecture, and thereby taking advantage of propagating energy and relative distances to allow for exploitation of mutual enhancing cancellation phenomenon and an electrostatic suppression phenomenon to exponentially allow layered conductive and dielectric elements to become highly efficient in energy handling ability.

According to an aspect of the present invention, a device may utilize a single low impedance pathway or a common low impedance pathway as a voltage reference, while utilizing a circuit maintained and balanced within a relative electrical reference point, thereby maintaining minimal parasitic contribution and disruptive energy parasitics in the isolated circuit system. The various attachment schemes described herein may allow a "0" voltage reference, as discussed hereinabove, to develop with respect to each pair or plurality of paired complementary conductors located on opposite sides of the shared central shield, thereby allowing a voltage to be maintained and balanced, even with multiple Simultaneous Switching Operations states among transistor gates located within an active integrated circuit, with minimal disruptive energy parasitics in an isolated circuit.

Shields may be joined using principals of a cage-like conductive shield structure to create one or more shieldings. The conductive coupling of shields together with a larger external conductive area may suppress radiated electromagnetic emissions and as a larger area provides a greater conductive area in which dissipation of voltages and surges may occur. One or more of a plurality of conductive or dielectric materials having different electrical characteristics may be maintained between shields. A specific complementary pathway may include a plurality of commonly conductive structures performing differentially phased conditioning with respect to a "mate", or paired, plurality of oppositely phased or charged structures forming half of the total sum of manufactured complementary pathways, wherein one half of the complementary pathways forms a first plurality of pathways, and wherein the second half forms a second plurality of pathways. The sum of the complementary pathways of the first and the second plurality of pathways may be evenly separated electrically, with an equal number of pathways used simultaneously, but with half the total sum of the individual complementary pathways operating from, for example, a range of 1 degree to approximately 180 degrees electrically out of phase from the oppositely positioned groupings. Small amounts of dielectric material, such as microns or less, may be used as the conductive material separation between pathways, in addition to the interposing shield, which dielectric may not directly physically or conductively couple to any of the complementarily operating shielded pathways.

An external ground area may couple or conductively connect as an alternative common pathway. Additional numbers of paired external pathways may be attached to lower the circuit impedance. This low impedance phenomenon may occur using alternative or auxiliary circuit return pathways.

A shield architecture may allow shields to be joined together, thereby facilitating energy propagation along a newly developed low impedance pathway, and thereby allowing unwanted electromagnetic interference or noise to move to this created low impedance pathway.

Referring now to FIG. 1A through FIG. 5B, which generally show various common principals of both common and

individual variants of an exemplary embodiment configured in a co-planar variant (FIGS. 1A-4I) and a stacked variant (FIGS. 5A and 5B).

In FIG. 1A, there are shown relative locations of the various pathway extensions disclosed according to an aspect of the present invention. A portion of a relative balanced and complementary-symmetrical arrangement utilizing a center shielding pathway designated 8"XX"- "X" M is adapted in the arrangement as the fulcrum of balanced conductive portions in a co-planar variant. A pathway arrangement including at least a first and a second plurality of pathways, wherein the first plurality has at least one pair of pathways arranged electrically isolated from each other and orientated in a first complementary relationship, is illustrated. Additionally, at least a first half of the second plurality is arranged electrically isolated from a second half of the second plurality, wherein at least two pathways of the second plurality are electrically isolated from the pathways of first plurality. The pathway arrangement may also include a material having properties, such as dielectric, ferromagnetic, or varistor for example, spacing apart pathways of the pathway arrangement. The pathways of the first half of the second plurality are electrically coupled to one another, and the pathways of the second half of the second plurality are electrically coupled to one another. A total number of pathways of the first half of the second plurality may be an odd number greater than one, and a total number of pathways of a second half of the second plurality may also be an odd number greater than one. According to an aspect of the present invention, the pathways of the first half of the second plurality are positioned in a first superposed alignment, while the pathways of the second half of the second plurality are positioned in a second superposed alignment, with the first and second superposed alignments in a mutual superposed alignment herein defined as a co-planar arrangement.

In a non co-planar arrangement, the pathways of the first half of the second plurality may be positioned in a first superposed alignment, and the pathways of the second half of the second plurality may be positioned in a second superposed alignment, with the first and second superposed alignments in arrangement one atop the other. In one arrangement, at least four pathways are electrically isolated.

An illustrative embodiment of the present invention may include at least three pluralities of pathways, including a first plurality of pathways and a second plurality of pathways. The first and second pluralities of pathways may include pathway members of the first plurality having an equal and opposite pathway member found in the second plurality of pathways. Members of the first and second pluralities of pathways may be substantially the same size and shape, and may be positioned complementary, and may also operate in an electrically complementary manner. Thus, the pairings of the first and second pluralities of pathways may result in identical numbers of members of the first and second pluralities of pathways. An exemplary embodiment may provide at least a first and a second shield allowing for development of individual isolated low circuit impedance pathways. Structurally, the shields may be accomplished by a third plurality of pathways and a fourth plurality of pathways. Each shielding plurality may include shields of equal size and shape. Each of the third and fourth plurality of pathways may be conductively coupled. Conductive coupling may be accomplished by a variety of methods and materials known to those possessing an ordinary skill in the pertinent arts. Thus, when the third and a fourth plurality are grouped as two sets of shields utilizing the first and second plurality receiving shielding, the third and fourth pluralities may be coupled to a common pathway to

develop a low circuit impedance pathway for energy propagation for conditioning of the circuit energy.

Pathways may additionally be arranged in a bypass arrangement, such that when placed face to face, main-body pathways **80** may be aligned superposed, with the exception of any pathway extensions such as **812NNE**, **811NNE**, **812SSW** and **811SSW** of the lower sub-circuit portion, for example, shown as mirror images depicted in FIG. 5A and FIG. 5B, for example.

Within the pluralities, individual pathway members may be of substantially the same size and shape and may be conductively coupled. However, individual pathway members of one plurality may not be conductively coupled to members of a different plurality of pathways. There may be situations wherein members of one plurality may be connected to members of a different plurality, such as wherein a first plurality of shields and a second plurality of shields are externally coupled to the same conductor.

Common elements may include energy flow in accordance with conceptual energy indicators **600**, **601**, **602**, **603** depicting the dynamic energy movements in co-planar shielded by-pass pathways, such as those shown in FIGS. 1A-1C. An embodiment may provide for at least multiple shields for development of multiple isolated low circuit impedance pathways for multiple circuits.

Referring still to FIG. 1A, pathways may be shielded by the relative, common pathways, and may include a main-body pathway **80** with at least one pathway extension **812“X”**. The shields shown include a main-body shield pathway **81** with at least one pathway extension designated **99“X”/79“X”**. The shields may sandwich and envelope the main-body **799**, including a conductive inner pathway formed of conductive materials from the family of noble or base metals traditionally used in co-fired electronic components or conductive material, such as Ag, Ag/Pd, Cu, Ni, Pt, Au, Pd, or combination materials such as metal oxide and glass frit. A capacitance and a resistance value may be achieved in one family of pathways, as described hereinabove, such as by use of ruthenium oxide as the resistive material and Ag/Pd as the conductive material. Further, variations in pathway geometry may yield different resistance and capacitance values. Variations may be achieved by altering the materials from which the pathways are made. For example, a conductive metal, such as silver, may be selectively added to the metal oxide/glass frit material to lower the resistance of the material.

A plurality of pathways, **865-1** and **865-2**, are shown positioned co-planar and spaced apart on a same portion of material **801**. Each pathway of the co-planar pathways **865-1** and **865-2**, may be formed of conductive material **799**, or a hybrid of conductive material and another material, herein designated as **799“x”**. Each co planar pathway **865-1** and **865-2** may also be formed as a bypass pathway, wherein each pathway includes a main-body pathway **80** having a corresponding main-body edge and perimeter, **803A** and **803B**, respectively and at least one pathway contiguous extension **812“X”**. Each co-planar pathway **865-1** and **865-2**, may include at least one pathway contiguous extension **812SSW** and **811SSW** with a portion of the main-body edge **803A** and **803B** extending therefrom. Extension **812“X”** is a portion of the pathway material formed in conjunction with a main-body pathway **80** from which it extends. Main-body pathway **80**, an **812“X”** may be found as an extension of material **799** or **799“x”** extending beyond an accepted average perimeter edge **803“X”**. Extensions **812“X”** and **79“X”** may be found respectively positioned as a contiguous portion of the pathway from which it is formed. Each main-body pathway may have edge **803A**, **803B** positioned relative and spaced apart a

distance **814F** from the embodiment edge **817**. Embodiment edge **817** may include a material **801**. Co-planar main-body pathway's edge **803“x”** may be positioned and spaced apart a distance **814J**. Pathway extensions **812SSW** and **811SSW** may conductively couple a respective pathway main-body **80** to an outer pathway **890SSW** and **891SSW**, which may be positioned at edge **817**. The co-planar arranged, main-body pathway **80** may be positioned “sandwiched” between the area of registered coverage of two layering of co-planar, main-body pathway **81s**.

Combining mutually opposing fields causes a cancellation or minimization effect. The closer the complementary, symmetrically oriented shields, the better the resulting mutually opposing cancellation effect on opposing energy propagation. The more superposed the orientation of the complementary, symmetrically oriented shields is, the better the resulting suppression of parasitics and cancellation effect.

Referring still to FIG. 1A, the edges of the plurality of co-planar shields may be represented by dotted lines **805A** and **805B**. Main-body pathways **81** of each of the plurality of shields are larger than a sandwiching main-body pathway **80** of any corresponding sandwiched pathway. This may create an inset area **806** relative to the positions of the shields and remaining pathways. The size of main-bodies **80** and **81** may be substantially similar, and thus the inset positioning relationships may be minimal in certain embodiments. Increased parasitic suppression may be obtained by inseting pathways, including a main-body **80**, to be shielded by larger pathway main-body **81s**. For example, an inset of a main-body **80** of pathways **865-1** inset may be separated a distance of 1 to 20+ times the spacing provided by the thickness of the material **801** separating pathway **865-1** and adjacent center co-planar pathway **800-1-IM**, as illustrated in FIG. 1B. Plurality of co-planar shield edges **805A** and **805B** may be positioned and spaced apart a distance **814K**, and may be a distance **814** relative to edges **805A** and **805B** and the edge **817**. Other distances **814J** relative from either edges **803A** and **803B** may be provided. Further, distance **814F** may be present between one **803“X”** and an edge **817**. Each co-planar shield may include a plurality of contiguous pathway extension portions, such as, for example, portions **79NNE**, **79SSE**, **99NNE** and **99SSE**, extending from the plurality of co-planar shield edges **805A** and **805B**. Plurality of co-planar shields may include a plurality of outer pathway material **901NNE**, **901SSE**, **902NNE** and **902SSE** positioned at the edge **817**. Conceptual energy indicators **602** represent the various dynamic energy movements within the co-planar pathways **865-1** and **865-2**. Unwanted energy may be transferred to the co-planar shields in accordance with the provision by the shields providing for a low impedance pathway, which shields may additionally be electrically coupled to another pathway or conductive area.

Referring now to FIGS. 1B and 1C, layer sequences are illustrated for a first plurality of co-planar pathways **865-1**, **865-2**, a second plurality of co-planar pathways **855-1**, **855-2**, and a third plurality of co-planar pathways **825-1-IM**, **825-2-IM**, **815-1**, **815-2**, **800-1-IM**, **800-2-IM**, **810-1**, **810-2**, and **820-1-IM**, **820-2-IM**. The first, second, and third pluralities may be stacked to form an embodiment **3199**, **3200**, **3201**. The third plurality of co-planar pathways may provide shielding. Main-bodies **81** of the plurality of co-planar shields **825-1-IM**, **825-2-IM**; **815-1**, **815-2**; **800-1-IM**, **800-2-IM**; **810-1-IM**, **810-2-IM**; and **820-1-IM**, **820-2-IM** may be substantially similar in size and shape, and may be spaced apart in co-planar locations on different layers of material **801**. The first plurality of co-planar pathways **865-1** and **865-2** may have at least the corresponding, opposing, and complementary sec-

ond plurality of co-planar pathways **855-1** and **855-2**. These first and second pluralities of co-planar pathways, when oriented face to face, may have main-body pathways **80s** co-registered and aligned except for the various contiguous pathway extensions **812“X”**, **811“X”**. As shown in FIGS. **1B** and **1C**, a pair of outer co-planar pathways **820-1-IM**, **825-1-IM** may serve as pathway shields, thereby improving the shielding effectiveness of the other conductively coupled pluralities of pathways with a main-body **81s**.

As illustrated in the varied embodiments **3199**, **3200**, **3201**, the location of extensions **79NNE**, **79SSE**, of shields **825-1-IM**, **815-1**, **800-1-IM**, **810-1**, and **820-1-IM** and extensions **99NNE**, **99SSE** of the shields **825-2-IM**, **815-2**, **800-2-IM**, **810-2**, and **820-2-IM**, may be varied. In FIG. **1B**, for example, extensions **79NNE** and **99NNE** may be arranged spaced apart, diagonally from extensions **79SSE** and **99SSE** and on opposite sides of shield main-body **81**. In FIG. **1C**, for example, extensions **79NNE** and **99NNE** may be arranged spaced apart in line with extensions **79SSE** and **99SSE** on opposite sides of shield main-body **81**. In FIG. **1B**, extensions **812NNE** and **811 NNE** may be arranged spaced apart, extending toward the same edge **812** of layer of material **801**, and extensions **812SSW** and **811 SSW** may be arranged spaced apart, each extending toward the opposite edge **812** of layer of material **801**. In FIG. **1C**, pathways **865-1** and **865-2** may be mirror images, as discussed hereinabove. Comparably to FIG. **1B**, extensions **812NNE** and **811NNE** may be arranged spaced apart, extending toward opposite edges **817** of layer of material **801**. Extensions **812SSW** and **811SSW** may be arranged spaced apart, extending toward the opposite edge of layer of material **801**, such that extensions **812NNE** and **811SSW** extend toward opposite edges **812“X”** of the respective layer of material **801**.

Referring now to FIGS. **2A** and **2B**, FIG. **2A** illustrates a schematic plan view of an embodiment of FIG. **2B** according to an aspect of the present invention.

FIG. **2B** depicts a pathway arrangement including a layout of a first, a second, a third, a fourth, a fifth, a sixth, a seventh, a eighth, a ninth and a tenth pathway, wherein at least the third and the fourth pathway, for example, may be co-planar and arranged spaced apart from each other. FIG. **2B** illustrates the first and the second pathway arranged below the third and the fourth pathway, and the fifth and the sixth pathway arranged above the third and the fourth pathway, and the seventh and the eighth pathway arranged above the fifth and the sixth pathway, and the ninth and the tenth pathway, arranged above the seventh and the eighth pathway. These pathways have various respective internal contiguous pathway extensions **812“X”**, **811“X”**, **79“X”** and **99“X”**, and may be discrete components having the same minimal numbers of layering. Internal contiguous pathway extensions **812“X”**, **811“X”**, **79“X”** and **99“X”**, and conductively coupled external pathways **890“X”**, **891“X”**, **802“X”** and **902“X”**, may be coupled to the inner pathway of the plurality of co-planar pathways of the main-body pathway **80** and **81**.

Referring now to FIGS. **3A** and **3B**, in FIG. **3A** there is shown a schematic plan view of an embodiment of FIG. **3B**, wherein outer pathways may be selectively conductively coupled in at least two isolated circuit portions. FIG. **3B** depicts a pathway arrangement including a minimal layout of a first, a second, a third, a fourth, a fifth, a sixth, a seventh, a eighth, a ninth and a tenth pathway, wherein at least the third and the fourth pathway, for example, are co-planar and arranged spaced apart from each other. The device shown in FIG. **3B** may have the first and the second pathway arranged below the third and the fourth pathway, and the fifth and the sixth pathway arranged above the third and the fourth path-

way, and the seventh and the eighth pathway arranged above the fifth and the sixth pathway, and the ninth and the tenth pathway arranged above the seventh and the eighth pathway. These pathways have various respective internal contiguous pathway extensions **812“X”**, **811“X”**, **79“X”** and **99“X”**, and may be discrete components having the same minimal number of layering.

Referring now to FIG. **3C**, a plan view of a shield according to an aspect of the present invention is illustrated. The embodiment depicted in FIG. **3C** includes at least one additional pathway, as compared to the device of FIG. **3B**. This additional pathway **1100-IM“X”** may be one of at least a plurality of shields in the stack of pathways, which shields may span across the two circuit portions. Pathway **1100-IM“X”** may be one of at least two outer sandwiching shields in the stack of pathways. Shields may span across the two circuits by adding a centrally arranged **1100-IM“X”** pathway electrically coupled to the outer **1100-IM“X”** shields. Pathways **1100-IM“X”** may have at least one extension, and are illustrated with two extensions **1099E** AND **1099W**, and may allow for sandwiching shields for all of the pathways within the present invention. At least three shields may be coupled together and may include a centering shield dividing an energy load or energy source of an isolated circuit or dividing two isolated circuits.

A shield **00GS** may be electrically isolated from other shields and may be arranged to effect an energy propagation of an isolated circuit. An isolated circuit may be sandwiched by a shield. A shield may be electrically coupled to a conductive area that is isolated from any other conductive areas thereby effecting an energy propagation.

FIGS. **4A-4I** depict assembled components of various embodiments according to aspects of the present invention. The arrangements of FIG. **4A** to FIG. **4I** may include minimal layouts of a first, a second, a third, a fourth, a fifth, a sixth, a seventh, a eighth, a ninth and a tenth pathway, wherein at least the third and the fourth pathway, for example, are co-planar and arranged spaced apart from each other. The first and the second pathway may be arranged below the third and the fourth pathway, and the fifth and the sixth pathway may be arranged above the third and the fourth pathway, and the seventh and the eighth pathway may be arranged above the fifth and the sixth pathway, and the ninth and the tenth pathway may be arranged above the seventh and the eighth pathway. These pathways have various respective internal contiguous pathway extensions **812“X”**, **811“X”**, **79“X”** and **99“X”**, and may be an assembled final discrete component, for example.

Referring to FIG. **5A**, there is shown a stacking of multiple, non-shared circuits including groups of pathways according to an aspect of the present invention. Included in FIG. **5A** is a marker **1000** showing a continuation of the stacking arrangement to the next column of FIG. **5A**. Conceptual energy indicators **600**, **601**, **602**, **603** indicate energy flow. Material **799** may be deposited on material **801** for component **6900** shields designated **815-1**, **800-1-IM**, **810-1**, **815-2**, **800-2-IM**, and **810-2**. Shields **810-A** and **810-B** are separated shields of at least part of an isolated circuit system. Shields **815-A** and **815-B** are separated shields of at least part of an isolated circuit system. Shields **800-A** and **800-B** are separated shields of at least part of an isolated circuit system. Shields **835-A** and **835-B** are separated shields of at least part of an isolated circuit system.

Conductors **855-1** and **855-2** are separated and shielded pathways in bypass configuration. Conductors **865-1** and **865-2** are separated and shielded pathways in bypass configuration. In FIG. **5A**, a pathway arrangement is depicted includ-

ing at least six orientations of pathways of two types of pathways, wherein each orientation of the pathways of the at least six orientations of pathways provides conductive isolation from the remaining orientations of pathways.

Referring to FIG. 5B, there is shown a stacked shield structure according to an aspect of the present invention. FIG. 5B depicts an embodiment similar to that of FIG. 5A, wherein two sets of **855**"X" and **865**"X" pathways are omitted for purposes of clarity, and wherein the shields of FIG. 5A are oriented in flip-flop for each relative set of **855**"X" and **865**"X" pathways. The **79**"X" pathway extensions may be rotated 90 degrees relative to the various pathway extensions **811**"x" and **812**"X". A dynamic result of this configuration, as illustrated by the conceptual energy indicators, may be enhanced by nulling the extensions of the two sets of **855**"X" and **865**"X" pathways of the two isolated circuits, and by relatively positioning the shield of each isolated circuit pairing **855A** and **865A** approximately 90 degrees null to the various pathway extensions of **855B** and **865B**.

Referring to FIG. 5B, there is shown a stacked shield structure according to an aspect of the present invention. FIG. 5B depicts an embodiment similar to that of FIG. 5A, wherein two sets of **855**"X" and **865**"X" pathways are omitted for purposes of clarity, and wherein the shields of FIG. 5A are oriented in flip-flop for each relative set of **855**"X" and **865**"X" pathways. The **79**"X" pathway extensions may be rotated 90 degrees relative to the various pathway extensions **811**"x" and **812**"X". A dynamic result of this configuration, as illustrated by the conceptual energy indicators, may be enhanced by nulling the extensions of the two sets of **855**"X" and **865**"X" pathways of the two isolated circuits, and by relatively positioning the shield of each isolated circuit pairing **865B** and **865A** approximately 90 degrees null to the various pathway extensions of **865B** and **865A**.

As discussed hereinabove, in an embodiment of the present invention, multiple complementary or paired shielded pathways may include the first and second pluralities of pathways. Energy may utilize the various paired, feed-through or bypass pathway layers in a generally parallel and even manner, for example. Pathway elements may include non-insulated and conductive apertures, and conductive through-VIAs, to provide propagating energy and maintain a generally non-parallel or perpendicular relationship, and additionally maintain a separate electrical relationship with an adjoining circuit. These pathways may maintain balance internally, and may facilitate an electrical opposition along opposing complementary pairings. This relationship among complementary pairs of pathways may occur while the pathways and the energy are undergoing an opposite operational usage within the shielding structure attached externally.

Referring now to FIG. 5C, there is shown a relative plan view of a stacked multiple, non-shared circuit network having VIAs and including groups of pathways according to an aspect of the present invention. The device according to an aspect of the present invention depicted in FIG. 5C includes a hole-through energy conditioner. Hole-through energy conditioners may be formed such that many of the energy propagation principals disclosed herein are retained, including the use of multiple sets of shields for energy conditioning possessing. FIG. 5C, further depicts null pathway sets with pathway arrangement **6969**. Pathway arrangement **6969** is similar to FIG. 5B, with the absence of pathway extensions **79**"X", **811**"x" and **812**"X", and with the substitution of **8879**"X", **8811**"X" and **8812**"X" VIAs functioning from a different direction relative to the main-body **80** and **81**.

Referring still to FIG. 5C, during the manufacturing process, conductive holes **912**, VIAS or conductive apertures

may be used to interconnect **8806** an integrated circuit, and may be formed through one or more pathway layers using mechanical drilling, laser drilling, etching, punching, or other hole formation techniques. Each specific interconnection **8806** may enable various pathways to be electrically connected or insulated. Each specific interconnection **8806** may extend through all layers of pathway arrangement **6969**, or may be bounded above or below by one or more layers. Pathway arrangement **6969** may include an organic substrate, such as an epoxy material, or patterned conductive material. If an organic substrate is used, for example, standard printed circuit board materials such as FR-4 epoxy-glass, polyimide-glass, benzocyclobutene, Teflon, other epoxy resins, or the like could be used in various embodiments. In alternate embodiments, a pathway arrangement could include an inorganic substance, such as ceramic, for example. In various embodiments, the thickness of the levels may be approximately 10-1000 microns. Interconnections **8806** between the various conductive layers may also be formed by selectively removing dielectric and conductive materials, thereby exposing the conductive material of the lower conductive layers **904** (not shown), and by filling the holes so formed by the removal with a conductive paste **799A** or electrolytic plating **799B**, for example.

Interconnections **8806** may couple exposed conductive layers to a relative side of the pathway arrangement **6969**. Interconnections **8806** may take the form of pads or lands to which an integrated circuit may be attached, for example. Interconnections **8806** may be formed using known techniques, such as by filling the selectively removed portions of dielectric with conductive paste, electrolytic plating, photolithography, or screen printing, for example. The resulting pathway arrangement **6969** includes one or more layers of patterned conductive material **799**, separated by non-conducting layers, and interconnected by interconnects **8806**. Different techniques may be used to interconnect and isolate the various layers of patterned conductive material **799**. For example, rather than forming and selectively removing portions of the various conducting **799** and non-conducting layers **801**, openings between the various layers may be included by selectively adding the desired portions of the conducting **799** and non-conducting layers **801**. Removal techniques, such as chemical mechanical planarization, may be used to physically abrade away multiple layers of different types of conducting and non-conducting materials, resulting in the desired openings for various interconnects.

Pathway arrangement **6969** may be configured using a multi-aperture, multilayer energy conditioning pathway set, with a substrate format adapted to condition propagating energy. Pathway arrangement **6969** may condition propagating energy by utilizing a combined energy conditioning methodology of conductively filled apertures, known in the art as VIAs **8879**"X", **8811**"X" and **8812**"X", in combination with a multi-layer common conductive Faraday cage-like shielding technology with immured propagational pathways. Interconnecting pathway arrangement and an IC may be achieved with wire bonding interconnection, flip-chip ball-grid array interconnections, microBall-grid interconnections, combinations thereof, or any other standard industry accepted methodologies. For example a "flip chip" type of integrated circuit, meaning that the input/output terminations as well as any other pathways on the chip may occur at any point on its surface. After the IC chip is prepared for attachment to pathway arrangement **6969**, the chip may be flipped over and attached, by solder bumps or balls to matching pads on the top surface of pathway arrangement **6969**. Alternatively, an integrated circuit may be wire bonded by connecting input/output

terminations to pathway arrangement **6969** using bond wires to pads on the top surface of pathway arrangement **6969**.

The circuits within pathway arrangement **6969** may act as a source to load pathway arrangement requiring capacitance, noise suppression, and/or voltage dampening. This capacitance may be provided by formation of the capacitance developed and embedded within pathway arrangement **6969**. This capacitance may be coupled to the integrated circuit loads using a paired pathway and the shield, as described above. Additional capacitance may be provided to a circuit electrically coupled to an integrated circuit to provide voltage dampening and noise suppression. Close proximity of off-chip energy sources may provide a capacitance each along the low inductance path to the load. Common shielding pathways may be utilized as the "0" voltage circuit reference node for both off-chip energy sources the common conductive interposer energy pathway configurations.

Pathway arrangement **6969** may be connected to an integrated circuit by commonly accepted industry connection methods and couplings **799A** and **799B**, including Bumpless Build-Up Layer (BBUL) packaging. This technology enables higher performance, thinner and lighter packages, and lowers power consumption. In a BBUL package, the silicon die or IC is embedded in a package with a pathway arrangement operable as a first level interconnect. Thus, the BBUL package as a whole is not just attached to one surface of the IC. For example, electrical connections between the die and one or more of the various shields and the package may be made with copper lines, not necessarily C4 solder bumps. These features combine to make the package thinner and lighter than other IC packages, while delivering higher performance and reducing power consumption. BBUL may enhance the ability of a manufacturer to couple multiple silicon components to pathway arrangement **6969**. Shielded pathways **8811**, **8812**, and **8879** may be electrically connected between respective energy sources and respective load of the IC by common industry methodologies, thereby allowing for conditioning of propagating energy. Shields **8879** may conductively coupled to a shield including **1055-2**. A shield and its other conductive portions including **8811** and **8812** may be electrically coupled to a respective complementary pathway which poses no polarity charge of significance before hook-up, thereby preventing each layer **8811** and **8812** from changing energy propagation direction functions, such preventing layer **8811** and **8812** from changing from input and output to output and input, respectively, as is understood by those possessing an ordinary skill in the pertinent arts.

For stacked variants depicted in FIGS. **5A**, **5B** and **5C**, adding three pathways **1100-IM-"X"**, including one between **810-1** and **815-2**, designated as **1100-IM-"C"**, may bisect a balanced symmetry of the total number of pathways located into equal numbers on opposite sides of **1100-IM-"C"**. The addition of **1100-IM-1** and **1100-IM-2**, electrically coupled to **1100-IM-C**, creates a common or a shield structure (not all shown). Shields of a shield structure may be of substantially the same size or not. Shields may or may not be physically isolated from any other shields for any one or more embodiments of the present invention. Thus, shields may or may not be electrically or conductively isolated from any other shields for any one or more embodiments of the present invention.

An odd number of shields may be coupled together thereby allowing formation of a common reference or node utilizing all other shields. The number of shields **1100-IM-"X"** is not confined to using extensions **1099E** and **1099W** such as shield **00GS**, as any number of extensions in almost any direction may be used to facilitate a coupling. A relative balanced and complementary-symmetrical arrangement may be formed

with respect to a center shield **8"XX"** or shield **800/800-IM** for a arrangement fulcrum of balanced conductive portions. At least a partial flux field cancellation of energy propagating along or between paired and electrically opposing complementary pathways occurs in this balanced but shifted embodiment. Further, simultaneous stray energy parasitics, complementary charged suppression, physical and electrical shielding containment and a faraday effect may also occur. This result is achieved because the magnetic flux energies travel at least partially along the shield wherein the RF return path is parallel and adjacent to a corresponding pathway. Thus, the magnetic flux energy may be measured or observed relative to a return. Shifted pathways may be in relative balance and complementarily and symmetrically positioned with respect to center shields, such as shields **800/800-"X"-IM**, and may include a relatively shifted, balanced, complementary, and symmetrical arrangement of predetermined shields and pathways complementarily sandwiched around a centrally positioned shield, such as **800/800-IM**, for example.

The exemplary embodiments of FIGS. **1A**, **1B**, **1C**, through FIG. **4I**, for example may include these 'shifted' embodiments. These shifted embodiments may include a multiplicity of layers having a shielding, a pathway, a shielding, a pathway, and a shielding. Each of these multiplicity of layers may be centered and complementary about a center shield **800/800-"X"-IM**, such as for co-planar variants, and the entire multiplicity of layers may be centered about a main center shield. Complementarity and balance may be maintained about the center shield, and the main center shield, although individual shields may be shifted to create discrete imbalances as between a given matched pathway pair, for example. Shifting may expose a portion of at least one pathway outside the perimeter of the superposed shielding, thereby allowing for parasitics and thereby varying, for example, impedance characteristics.

For example, a given pathway may be shifted 5 points to the left. This shifting may be accounted for in the matched pairs about a center shield, and, consequently, either an adjacent matched pair pathway of opposing polarity may be shifted 5 points, or 5 adjacent pathways of opposite polarity may each shift 1 point, thereby maintaining complementarity and balance. Further, pathways may remain within the perimeter of the superposed shielding, and nonetheless be shifted thereunder. Such a shifting under the shielding may, nonetheless, make desirable a balancing. However, certain exemplary embodiments not shown may include situations wherein pathways are pulled toward the center of a shield, and remain under the shield evidencing differing electrical characteristics, such as inductive behavior, in a balanced or unbalanced state.

Referring now to FIG. **6**, there is shown a stacked multiple circuit including embodiment **6900**, conductive energy pathways, isolated energy sources, isolated energy-utilizing loads, and isolated common conductive pathways. The conductive energy pathways may be conductively coupled to embodiment **6900** by a conductive coupling material, such as, for example, by a solder or industry equivalent. Vias **315**, conductive pathways continuing below the surface of the substrate, may couple to the conductive pathways, and may include conductive material that serves as a contiguous conductive pathway for propagating energies. The isolated common conductive pathways may not be directly coupled to the isolated energy sources or the isolated energy-utilizing loads. As discussed hereinabove, embodiment **6900** may include four pluralities of pathways including electrodes and shields, with each plurality electrically isolated. The shields may be conductively coupled. The conductively coupled shields may

be externally coupled to an isolated common conductive pathway, which is not directly conductively coupled to the electrodes, using a conductive coupling material. As shown in FIG. 6 an electrode, **815-1**, **800-1-IM** and **810-1**, may be conductively coupled to **802GA**, **802GB**. A shield, **815-2**, **800-2-IM**, and **810-2**, may be conductively coupled to **902GA** and **902GB**. These couplings may not be conductively coupled to the first plurality of electrodes or the second plurality of electrodes. In this configuration, both isolated circuits may be utilizing the isolated and separate voltage references and an isolated common impedance path such as REF 1 and REF 2 in FIG. 6.

Referring now to FIG. 7, there is shown a stacked co-planar multiple circuit including embodiment **3210**, conductive energy pathways, isolated energy sources, isolated energy-utilizing loads, and isolated common conductive pathways. The conductive energy pathways may be conductively coupled to embodiment **3210** by a conductive coupling material. Vias **315**, conductive pathways continuing below the surface of the substrate, may couple to the conductive pathways and may include conductive material that serves as a contiguous conductive pathway for propagating energies. The isolated common conductive pathways may not be directly coupled to the isolated energy sources or the isolated energy-utilizing loads. As discussed hereinabove, embodiment **3210** may include four pluralities of pathways including electrodes and shields, with each plurality electrically isolated. The conductively coupled shields may be externally coupled to an isolated common energy pathway, which is not directly conductively coupled to the first or the second plurality of electrodes in this co-planar arrangement. A third plurality of electrodes, **815-1**, **800-1-IM** and **810-1** may be conductively coupled to **802GA**, **802GB**, **815-2** and **800-2-IM**, and also, may be conductively coupled to **902GA**, **902GB**, and may not be conductively coupled to the first plurality or the second plurality. In this configuration, both isolated circuits may be utilizing a separate and a respective isolated and separate voltage reference and a separate and a respective isolated impedance path, a separate and a respective isolated common impedance path and at least one separate and respective low inductance pathway such as REF 1 and REF 2 in FIG. 7.

Referring now to FIG. 4A thru to FIG. 7, the termination electrodes **890A**, **890B**, and **891A**, **891B**, **802GA**, **802GB**, and **902GA**, **902GB**, may be monolithic or multi-layered. Termination electrodes **802GA**, **802GB**, **902GA**, **902GB**, may be located at other respective portions of a sintered body. Each main body electrode layers **81** or **80**, and the associate electrode extensions **99/79G"X"** or **812"X"**, may define an electrode which extends to, and conductively couples to, the associated termination electrodes **802GA**, **802GB**, **902GA**, **902GB** and **890A**, **890B**, and **891A**, **891B**.

The present invention may be utilized for many energy conditioning functions that utilize commonly coupled shielding structure element for emulating a center tap of resistor/voltage divider network. This resistor/voltage divider network may be normally constructed using a ratio of various integrated circuit resistors. However, various integrated circuit resistors may be replaced by a device according to an aspect of the present invention, the device utilizing, for example, specific conductive/resistive materials **799A** or naturally occurring resistance properties of pathway material **799**, or utilizing a varied physical layout. A voltage dividing function may be present as portions of a common and shared pathway shield structure are utilized to define a common voltage reference located at both respective sides of the common pathway shield structure.

In embodiments, whether initially stacked vertically during a manufacturing process, or in combination with a coplanar pairings as described hereinabove, the number of complementary pathways pairings may be multiplied in a predetermined manner to create a number of pathway element combinations of a generally physically or electrically parallel nature.

Further, although not shown, a device of the present invention may be fabricated in silicon and directly incorporated into integrated circuit microprocessor circuitry or microprocessor chip packaging. Any suitable method for depositing electrically conductive materials may be used, such as plating, sputtering, vapor, electrical, screening, stenciling, vacuum, and chemical including chemical vapor deposition (CVD).

While certain embodiments have been herein described in position as "upper" or "above", or "lower" or "below", or any other positional or directional description, it will be understood that these descriptions are merely relative and are not intended to be limiting.

The present invention may be implemented in a number of different embodiments, including a energy conditioning embodiment as an energy conditioner for an electronic assembly, an energy conditioning substrate, an integrated circuit package, an electronic assembly or an electronic system in the form of a energy conditioning system, and may be fabricated using various methods. Other embodiments will be readily apparent to those of ordinary skill in the art.

The invention claimed is:

1. A substrate with conductor arrangement comprising:
 - a first surface of said substrate and a second surface of said substrate;
 - a first conductor including a first conductive plane;
 - a second conductor including a second pathway portion;
 - a third conductor including a third conductive plane;
 - a fourth conductor including a fourth pathway portion;
 - a fifth conductor including a fifth conductive plane; and
 - a plurality of conductive structures;
 wherein said first conductor, said third conductor and said fifth conductor are conductively coupled to one another by said plurality of conductive structures, and wherein said first conductor, said third conductor, said fifth conductor and said plurality of conductive structures are electrically insulated from said second conductor and said fourth conductor;
 - wherein an area of said third conductive plane is between an area of said second pathway portion and an area of said fourth pathway portion, and wherein said area of said second pathway portion, said area of said third conductive plane and said area of said fourth pathway portion are between an area of said first conductive plane and an area of said fifth conductive plane;
 - wherein said area of said first conductive plane, said area of said second pathway portion, said area of said third conductive plane, said area of said fourth pathway portion, and said area of said fifth conductive plane are between said first surface of said substrate and said second surface of said substrate;
 - wherein said area of said first conductive plane is larger than said area of said second pathway portion, and wherein said area of said third conductive plane is larger than said area of said second pathway portion, and wherein said area of said fifth conductive plane is larger than said area of said second pathway portion;
 - wherein said area of said first conductive plane is larger than said area of said fourth pathway portion, and wherein said area of said third conductive plane is larger

25

than said area of said fourth pathway portion, and wherein said area of said fifth conductive plane is larger than said area of said fourth pathway portion; and wherein said area of said second pathway portion and said area of said fourth pathway portion are shielded from each other by said area of said third conductive plane, and wherein said area of said second pathway portion and said area of said fourth pathway portion are oriented facing each other.

2. The substrate with conductor arrangement of claim 1, wherein a portion of said area of said second pathway portion and a portion of said area of said fourth pathway portion are positioned in a superposed alignment.

3. The substrate with conductor arrangement of claim 2, wherein said second conductor and fourth conductor are each a feed-through pathway; and

wherein said second conductor and said fourth conductor are electrically insulated from each other.

4. The substrate with conductor arrangement of claim 1, wherein said second conductor and said fourth conductor are electrically insulated from each other;

wherein said second conductor is operable for conductive connection to an integrated circuit, and wherein said fourth conductor is operable for conductive connection to an integrated circuit; and

wherein said second conductor and fourth conductor are each a feed-through pathway.

5. The substrate with conductor arrangement of claim 4, wherein at least one conductive structure of said plurality of conductive structures is a conductively-filled aperture.

6. The substrate with conductor arrangement of claim 4, wherein a first conductive structure of said plurality of conductive structures is a plated through hole via.

7. The substrate with conductor arrangement of claim 6, wherein a second conductive structure of said plurality of conductive structures is a blind via.

8. The substrate with conductor arrangement of claim 7, wherein a portion of said area of said second pathway portion and a portion of said area of said fourth pathway portion are positioned in a first superposed alignment.

9. An arrangement for energy conditioning, comprising:

a surface of said arrangement;

a first energy pathway including a first energy pathway portion;

a second energy pathway including a second energy pathway portion;

a third energy pathway including a third energy pathway portion;

a fourth energy pathway including a fourth energy pathway portion;

a fifth energy pathway including a fifth energy pathway portion;

wherein said first energy pathway portion, said second energy pathway portion, said third energy pathway portion, said fourth energy pathway portion, and said fifth energy pathway portion are located below said surface of said arrangement;

wherein said first energy pathway portion, said third energy pathway portion and said fifth energy pathway portion are each larger than said second energy pathway portion, and wherein said first energy pathway portion, said third energy pathway portion and said fifth energy pathway portion are each larger than said fourth energy pathway portion;

wherein said third energy pathway portion is between said second energy pathway portion and said fourth energy pathway portion, and wherein said second energy pathway

26

way portion is in a superposed alignment with said fourth energy pathway portion;

wherein said second energy pathway portion, said third energy pathway portion and said fourth energy pathway portion are between said first energy pathway portion and said fifth energy pathway portion, and wherein said second energy pathway portion is shielded from said fourth energy pathway portion by said third energy pathway portion;

wherein said second energy pathway portion is spaced apart a first distance from said third energy pathway portion by a first dielectric material layer, and wherein said fourth energy pathway portion is spaced apart said first distance from said third energy pathway portion by a second dielectric material layer;

wherein said first energy pathway, said third energy pathway and said fifth energy pathway are conductively coupled to each other, and wherein said first energy pathway, said third energy pathway, said fifth energy pathway are conductively isolated from said second energy pathway and said fourth energy pathway, and wherein said second energy pathway and said fourth energy pathway are conductively isolated from each other; and

wherein said second energy pathway is operable for a first conductive connection to an integrated circuit chip, and wherein said fourth energy pathway is operable for a second conductive connection to said integrated circuit chip.

10. The arrangement for energy conditioning of claim 9, wherein said arrangement includes at least three pluralities of vias, including a first plurality of vias, a second plurality of vias and a third plurality of vias.

11. The arrangement for energy conditioning of claim 10, wherein said third energy pathway and said fifth energy pathway are conductively coupled to each other by a first via of said first plurality of vias.

12. The arrangement for energy conditioning of claim 11, wherein said third energy pathway and said first energy pathway are conductively coupled to each other by a second via of said first plurality of vias.

13. The arrangement for energy conditioning of claim 12, wherein a first predetermined capacitance is operable between said third energy pathway portion and said second energy pathway portion when said arrangement is energized; wherein a second predetermined capacitance is operable between said third energy pathway portion and said fourth energy pathway portion when said arrangement is energized;

wherein a third predetermined capacitance is operable between said second energy pathway portion and said fourth energy pathway portion when said arrangement is energized; and

wherein a capacitance value of said first predetermined capacitance is substantially the same as a capacitance value of said second predetermined capacitance when said arrangement is energized.

14. The arrangement for energy conditioning of claim 13, wherein a capacitance value of said third predetermined capacitance is approximately one half of said capacitance value of said second predetermined capacitance.

15. The arrangement for energy conditioning claim 13, wherein said second energy pathway is operable for a first conductive connection to an integrated circuit chip; and

wherein said fourth energy pathway is operable for a second conductive connection to said integrated circuit chip.

27

16. The arrangement for energy conditioning of claim 15, wherein said arrangement is configured to simultaneously condition energies that are propagating to and from said integrated circuit chip when said integrated circuit chip is energized.

17. The arrangement for energy conditioning of claim 12, wherein at least one via of said at least three pluralities of vias is a conductive via.

18. The arrangement for energy conditioning of claim 17, wherein at least one via of said at least three pluralities of vias is a non-blind via.

19. The arrangement for energy conditioning of claim 18, wherein at least one via of said at least three pluralities of vias is a blind via.

20. The arrangement for energy conditioning of claim 19, wherein at least one via of said at least three pluralities of vias is a conductively filled via.

21. The arrangement for energy conditioning of claim 17, wherein a first predetermined capacitance is operable between said third energy pathway portion and said second energy pathway portion when said arrangement is energized; wherein a second predetermined capacitance is operable between said third energy pathway portion and said fourth energy pathway portion when said arrangement is energized; and wherein a third predetermined capacitance is operable between said second energy pathway portion and said fourth energy pathway portion when said arrangement is energized.

22. The arrangement for energy conditioning of claim 20, wherein said second energy pathway is configured as a feed-through energy pathway operable for a first conductive connection to an integrated circuit chip;

wherein said fourth energy pathway is configured as a feed-through energy pathway operable for a second conductive connection to said integrated circuit chip; and wherein a conductive structure comprising said first energy pathway, said third energy pathway and said fifth energy pathway is operable for a third conductive connection to said integrated circuit chip.

23. The arrangement for energy conditioning of claim 17, wherein said second energy pathway is configured as a feed-through energy pathway, and wherein said fourth energy pathway is configured as a feed-through energy pathway.

24. The arrangement for energy conditioning of claim 21, further comprising:

a sixth energy pathway including a sixth energy pathway portion;

a seventh energy pathway including a seventh energy pathway portion;

an eighth energy pathway including an eighth energy pathway portion;

a ninth energy pathway including a ninth energy pathway portion;

a tenth energy pathway including a tenth energy pathway portion;

wherein said sixth energy pathway portion, said seventh energy pathway portion, said eighth energy pathway portion, and said tenth energy pathway portion are located below said first energy pathway portion, said second energy pathway portion, said third energy pathway portion, said fourth energy pathway portion, and said fifth energy pathway portion;

wherein said sixth energy pathway portion, said eighth energy pathway portion and said tenth energy pathway portion are each larger than said seventh energy pathway

28

portion, and wherein said sixth energy pathway portion, said eighth energy pathway portion and said tenth energy pathway portion are each larger than said ninth energy pathway portion;

wherein said eighth energy pathway portion is between said seventh energy pathway portion and said ninth energy pathway portion, and wherein said seventh energy pathway portion, said eighth energy pathway portion and said ninth energy pathway portion are between said sixth energy pathway portion and said tenth energy pathway portion;

wherein said seventh energy pathway portion is shielded from said ninth energy pathway portion by said eighth energy pathway portion;

wherein said seventh energy pathway portion is spaced apart a third distance from said eighth energy pathway portion by dielectric material, and wherein said ninth energy pathway portion is spaced apart said third distance from said eighth energy pathway portion by said dielectric material; and

wherein said sixth energy pathway, said eighth energy pathway and said tenth energy pathway are conductively coupled to one another, and wherein said sixth energy pathway, said eighth energy pathway, said tenth energy pathway are conductively isolated from said seventh energy pathway and said ninth energy pathway.

25. The arrangement for energy conditioning of claim 24, wherein said seventh energy pathway and said ninth energy pathway are conductively isolated from each other.

26. An arrangement for energy conditioning, comprising: a first shielding electrode structure which comprises at least: a first electrode including a first shielding electrode portion, a third electrode including a third shielding electrode portion, and a fifth electrode including a fifth shielding electrode portion, wherein said first electrode, said third electrode and said fifth electrode are conductively coupled to one another;

a second electrode including a second shielded electrode portion;

a fourth electrode including a fourth shielded electrode portion;

wherein said second electrode and said fourth electrode are conductively isolated from each other;

wherein said second shielded electrode portion and said fourth shielded electrode portion are spaced apart from each other by at least a first dielectric material layer, said third shielding electrode portion, and a second dielectric material layer;

wherein said second shielded electrode portion is a first distance away from said third shielding electrode portion, and wherein said fourth shielded electrode portion is said first distance away from said third shielding electrode portion;

wherein said third electrode including said third shielding electrode portion of said first shielding electrode structure is larger in size than said second shielded electrode portion, and wherein said third electrode including said third shielding electrode portion of said first shielding electrode structure is larger in size than said fourth shielded electrode portion;

wherein said second shielded electrode portion and said fourth shielded electrode portion are in a first superposed alignment with each other; and

wherein said second shielded electrode portion and said fourth shielded electrode portion are stacked within said first shielding electrode structure, and wherein said sec-

29

ond shielded electrode portion is physically shielded from said fourth shielded electrode portion by said third shielding electrode portion.

27. The arrangement for energy conditioning of claim 26, wherein said first shielding electrode structure is conductively isolated from said second electrode; and

wherein said first shielding electrode structure is conductively isolated from said fourth electrode.

28. The arrangement for energy conditioning of claim 27, wherein said second shielded electrode portion is operable for a first conductive connection to an integrated circuit chip, and wherein said fourth shielded electrode portion is operable for a second conductive connection to said integrated circuit chip, and wherein said first shielding electrode structure is operable for a third conductive connection to said integrated circuit chip;

wherein said arrangement is operable for a first predetermined capacitance developed between said second shielded electrode portion and said first shielding electrode structure when said arrangement is energized;

wherein said arrangement is operable for a second predetermined capacitance developed between said fourth shielded electrode portion and said first shielding electrode structure when said arrangement is energized; and wherein said arrangement is operable for a third predetermined capacitance developed between said second shielded electrode portion and said fourth shielded electrode portion when said arrangement is energized.

29. The arrangement for energy conditioning of claim 28, wherein said arrangement is operable beyond 1 GHz for modifying an electrical transmission of energy to a predetermined electrical characteristic when said arrangement is energized.

30. The arrangement for energy conditioning of claim 29, wherein said modifying an electrical transmission of energy to a predetermined electrical characteristic includes flux field cancellation of energy between said second shielded electrode portion and said fourth shielded electrode portion when said arrangement is energized.

31. The arrangement for energy conditioning of claim 26, further comprising:

a second shielding electrode structure, which comprises: a sixth electrode including a sixth shielding electrode portion, a eighth electrode including a eighth shielding electrode portion, and a tenth electrode including a tenth shielding electrode portion, wherein said sixth electrode, said eighth electrode and said tenth electrode are conductively coupled to one another;

a seventh electrode including a seventh shielded electrode portion;

a ninth electrode including a ninth shielded electrode portion;

wherein said sixth shielding electrode portion, said seventh shielded electrode portion, said eighth shielding electrode portion, said ninth shielded electrode portion, and said tenth shielding electrode portion are located below said first shielding electrode structure;

wherein said seventh shielded electrode portion and said ninth shielded electrode portion are stacked within said second shielding electrode structure;

wherein said seventh shielded electrode portion is spaced apart a second distance from said eighth shielding electrode portion by dielectric material, and wherein said ninth shielded electrode portion is spaced apart said second distance from said eighth shielding electrode portion by said dielectric material;

30

wherein said seventh shielded electrode portion and said ninth shielded electrode portion are positioned on opposite sides of said eighth shielding electrode portion; and wherein said seventh shielded electrode portion is physically shielded from said ninth shielded electrode portion by said eighth shielding electrode portion.

32. The arrangement for energy conditioning of claim 31, wherein said first shielding electrode structure is conductively isolated from said second shielding electrode structure; and

wherein said seventh energy pathway and said ninth energy pathway are conductively connected to each other.

33. The arrangement for energy conditioning of claim 31, wherein said first shielding electrode structure is conductively connected to said second shielding electrode structure; and

wherein said seventh energy pathway and said ninth energy pathway are conductively connected to each other.

34. The arrangement for energy conditioning of claim 26, wherein said second electrode is a feed-through energy pathway, and wherein said fourth electrode is a feed-through energy pathway.

35. The arrangement for energy conditioning of claim 34, further comprising:

a surface of said arrangement;

wherein at least said first shielding electrode portion, said second shielded electrode portion, said third shielding electrode portion, said fourth shielded electrode portion, and said fifth shielding electrode portion are located below said surface of said arrangement.

36. The arrangement for energy conditioning of claim 31, further comprising:

a surface of said arrangement;

wherein at least said first shielding electrode portion, said second shielded electrode portion, said third shielding electrode portion, said fourth shielded electrode portion, and said fifth shielding electrode portion are located below said surface of said arrangement;

wherein at least said second electrode is a feed-through energy pathway; and

wherein said fourth electrode is a feed-through energy pathway.

37. The arrangement for energy conditioning of claim 26, further comprising:

a sixth electrode including a sixth shielded electrode portion;

a seventh electrode including a seventh shielded electrode portion;

wherein said sixth shielded electrode portion and said seventh shielded electrode portion are stacked within said first shielding electrode structure;

wherein said second shielded electrode portion and said sixth shielded electrode portion are co-planar with each other, and wherein said fourth shielded electrode portion and said seventh shielded electrode portion are co-planar with each other;

wherein said sixth shielded electrode portion and said seventh shielded electrode portion are spaced apart from each other by said first dielectric material layer, said third shielding electrode portion, and said second dielectric material layer;

wherein said sixth shielded electrode portion and said seventh shielded electrode portion are sandwiched by said first shielding electrode portion and said fifth shielding electrode portion;

31

wherein said sixth shielded electrode portion and said seventh shielded electrode portion are positioned in a second superposed alignment with each other;

wherein said second shielded electrode portion is physically shielded from said seventh shielded electrode portion by said third shielding electrode portion, and wherein said fourth shielded electrode portion is physically shielded from said sixth shielded electrode portion by said third shielding electrode portion; and

wherein said second electrode and said fourth electrode are conductively isolated from said sixth electrode and said seventh electrode, and wherein said sixth electrode and said seventh electrode are conductively isolated from each other.

38. The arrangement for energy conditioning of claim **37**, further comprising:

a surface of said arrangement;

wherein at least said first shielding electrode portion, said second shielded electrode portion, said sixth shielded electrode portion, said third shielding electrode portion, said fourth shielded electrode portion, said seventh shielded electrode portion and said fifth shielding electrode portion are located below said surface of said arrangement;

wherein said second electrode is a feed-through energy pathway, and wherein said fourth electrode is a feed-through energy pathway; and

wherein said sixth electrode is a feed-through energy pathway, and wherein said seventh electrode is a feed-through energy pathway.

39. The arrangement for energy conditioning of claim **38**, wherein a conductive material located on top of said surface of said arrangement is operable for a conductive attachment to a portion of an integrated circuit.

40. A method for making an energy conditioning arrangement operable for simultaneous filtering of differential mode and common mode energy propagations, said method comprising:

providing a plurality of conductors including:

(a) a first conductor having at least a shielding portion;

(b) a third conductor having at least a shielding portion that includes a first side shielding portion and a second side shielding portion;

(c) a fifth conductor having at least a shielding portion;

(d) a second conductor having at least a shielded portion including a second conductor shielded portion area that is smaller than an area of said first side shielding portion of said shielding portion of said third conductor; and

(e) a fourth conductor having at least a shielded portion including a fourth conductor shielded portion area that is smaller than an area of said second side shielding portion of said shielding portion of said third conductor;

insulating said first conductor, said third conductor and said fifth conductor from electrical contact with said second conductor and said fourth conductor;

insulating said second conductor from electrical contact with said fourth conductor;

arranging said area of said shielded portion of said second conductor parallel with said area of said first side shielding portion of said shielding portion of said third conductor;

arranging said area of said shielded portion of said fourth conductor parallel with said area of said second side shielding portion of said shielding portion of said third conductor;

32

arranging an area of said shielding portion of said first conductor and an area of said shielding portion of said fifth conductor parallel with said area of said shielded portion of said second conductor, said area of said first side shielding portion of said shielding portion of said third conductor; said area of said second side shielding portion of said shielding portion of said third conductor, and said area of said shielded portion of said fourth conductor;

positioning said area of said first side shielding portion of said shielding portion of said third conductor and said area of said second side shielding portion of said shielding portion of said third conductor between said area of said shielded portion of said second conductor and said area of said shielded portion of said second conductor; inseting said area of said shielded portion of said second conductor within said area of said first side shielding portion of said shielding portion of said third conductor; inseting said area of said shielded portion of said fourth conductor within said area of said second side shielding portion of said shielding portion of said third conductor; orienting said area of said shielded portion of said second conductor to face said area of said shielded portion of said fourth conductor;

stacking said area of said shielded portion of said second conductor over said area of said shielded portion of said fourth conductor so that said area of said shielded portion of said second conductor overlaps said area of said shielded portion of said fourth conductor;

connecting conductively said second conductor to an integrated circuit;

connecting conductively said fourth conductor to said integrated circuit; and

connecting conductively said first conductor, said third conductor, and said fifth conductor together.

41. The method of claim **40**, further comprising: arranging said first conductor, said third conductor and said fifth conductor to be operable as a common voltage reference for energy propagating along either of said second conductor or said fourth conductor when said integrated circuit is energized.

42. The method of claim **41**, further comprising: energizing said integrated circuit.

43. The method of claim **40**, further comprising: manufacturing said area of said shielded portion of said second conductor to be a first distance away from said area of said first side shielding portion of said shielding portion of said third conductor;

manufacturing said area of said shielded portion of said fourth conductor to be approximately said first distance away from said area of said second side shielding portion of said shielding portion of said third conductor; and energizing said integrated circuit.

44. The method of claim **40**, further comprising: providing a plurality of conductive vias operable for connecting at least said first conductor, said third conductor, and said fifth conductor conductively together.

45. The method of claim **40**, further comprising: making said arrangement operable for at least a noise cancellation function when said integrated circuit is energized.

46. The method of claim **44**, further comprising: making said shielding portion of first conductor, said shielding portion of said third conductor and said shielding portion of said fifth conductor operable for a dynamic shielding function when said integrated circuit is energized.

33

47. The method of claim 46, further comprising:
 making said arrangement operable for at least a noise cancellation function when said integrated circuit is energized; and
 energizing said integrated circuit.

48. The method of claim 45, further comprising:
 energizing said integrated circuit.

49. A method for making a conductor arrangement operable for simultaneous filtering of differential mode and common mode energy propagations, said method comprising:
 providing a first conductor having at least a first opposing side with a shielding conductor portion and a second opposing side with a shielding conductor portion;
 providing a second conductor having at least a first opposing side with a shielded conductor portion and a second opposing side with a shielded conductor portion;
 providing a third conductor having at least a first opposing side with a shielding conductor portion and a second opposing side with a shielding conductor portion;
 providing a fourth conductor having at least a first opposing side with a shielded conductor portion and a second opposing side with a shielded conductor portion;
 providing a fifth conductor having at least a first opposing side with a shielding conductor portion and a second opposing side with a shielding conductor portion;
 insulating said first conductor, said third conductor, said fifth conductor from said second conductor and said fourth conductor;
 insulating said second conductor from said fourth conductor;
 arranging all said shielded conductor portions and all said shielding conductor portions in parallel with one another;
 positioning all said shielding conductor portions of said third conductor between all said shielded conductor portions of said second conductor and all said shielded conductor portions of said fourth conductor;
 positioning all said shielded conductor portions of said second conductor, all said shielding conductor portions of said third conductor, and all said shielded conductor portions of said fourth conductor between all said shielding conductor portions of said first conductor and all said shielding conductor portions of said fifth conductor;
 providing an area of said shielded conductor portion of said second opposing side of said second conductor that is

34

smaller in size than an area of said shielding conductor portion of said first opposing side of said third conductor;
 providing an area of said shielded conductor portion of said first opposing side of said fourth conductor that is smaller in size than an area of said shielding conductor portion of said second opposing side of said third conductor;
 shielding all said shielded conductor portions of said second conductor from all said shielded conductor portions of said fourth conductor with at least said shielding conductor portion of said first opposing side of said third conductor;
 shielding all said shielded conductor portions of said fourth conductor from all said shielded conductor portions of said second conductor with at least said shielding conductor portion of said second opposing side of said third conductor;
 orienting said shielded conductor portion of said second opposing side of said second conductor to face said shielded conductor portion of said first opposing side of said fourth conductor;
 superposing said area of said shielded conductor portion of said second opposing side of said second conductor with said area of said shielded conductor portion of said first opposing side of said fourth conductor;
 connecting said second conductor to an integrated circuit operable for energy propagation between said second conductor and said integrated circuit when said integrated circuit is energized;
 connecting said fourth conductor to said integrated circuit operable for energy propagation between said fourth conductor and said integrated circuit when said integrated circuit is energized; and
 coupling conductively said first conductor, said third conductor and said fifth conductor together to be operable for:
 (a) shielding all said shielded conductor portions of said second conductor electrically from energy parasitics when said integrated circuit is energized;
 (b) shielding all said shielded conductor portions of said fourth conductor electrically from energy parasitics when said integrated circuit is energized; and
 (c) providing a simultaneous voltage reference for energy utilizing any one of said shielded conductor portions of any one of said conductors of said conductor arrangement when said integrated circuit is energized.

* * * * *