



US006712702B2

(12) **United States Patent**  
**Goldberg et al.**

(10) **Patent No.:** **US 6,712,702 B2**  
(45) **Date of Patent:** **Mar. 30, 2004**

(54) **METHOD AND SYSTEM FOR PLAYING GAMES ON A NETWORK**

**FOREIGN PATENT DOCUMENTS**

(76) Inventors: **Sheldon F. Goldberg**, 3360 E. Serene, Henderson, NV (US) 89014; **John Van Antwerp**, 110 E. Perry St., Pittsfield, IL (US) 62363

DE	733983	4/1943	.....	21/72
DE	29 18 846	11/1980	.....	H04N/5/64
DE	33 25 810 C2	10/1985	.....	H04N/6/64
DE	36 21 263 A1	7/1988	.....	G11B/21/0808
EP	660179	11/1980		
EP	0113022 A2	11/1983	.....	H04M/11/08
EP	279297	8/1988		
EP	290207	11/1988		
EP	307925	3/1989		
EP	370146	5/1990		

(\* ) Notice: Subject to any disclaimer, the term of this patent is extended or adjusted under 35 U.S.C. 154(b) by 151 days.

(List continued on next page.)

(21) Appl. No.: **09/811,173**

**OTHER PUBLICATIONS**

(22) Filed: **Mar. 16, 2001**

(65) **Prior Publication Data**

U.S. patent application Ser. No. 09/502,285, Goldberg et al., filed Feb. 11, 2000.

US 2003/0060247 A1 Mar. 27, 2003

(List continued on next page.)

**Related U.S. Application Data**

*Primary Examiner*—Kim Nguyen

(63) Continuation of application No. 09/140,979, filed on Aug. 27, 1998, now Pat. No. 6,264,560, and a continuation-in-part of application No. 09/105,401, filed on Jun. 26, 1998, now Pat. No. 6,183,366, which is a continuation of application No. 08/759,895, filed on Dec. 3, 1996, now Pat. No. 5,823,879.

(74) *Attorney, Agent, or Firm*—Grossman & Flight, LLC

(60) Provisional application No. 60/058,006, filed on Aug. 28, 1997, provisional application No. 60/010,361, filed on Jan. 19, 1996, and provisional application No. 60/010,703, filed on Jan. 26, 1996.

**ABSTRACT**

(51) **Int. Cl.**<sup>7</sup> ..... **A63F 9/24**  
(52) **U.S. Cl.** ..... **463/42**  
(58) **Field of Search** ..... 463/26, 27, 11, 463/12, 13, 14, 15, 7, 30, 31, 35; 273/236, 237

The present invention is a game playing method and apparatus for automating games such as blackjack, poker, craps, roulette, baccarat and pai gow, wherein players may play continuously and asynchronously, and information related to advertised items can be exchanged between players and advertisers. In one embodiment, each instance of a game is likely unique from all other current game instances. The games do not require a manual dealer and in one embodiment, played in a gaming establishment using low cost gaming stations. The present invention may also be used to play such games on the Internet or an interactive cable television network wherein a game controller communicates with players at network nodes in their homes and at their leisure since there is no game tempo requirement. During a game, advertising is selectively provided by comparing player personal information with a desired demographic profile. Player responses to advertising are used for evaluating advertising effectiveness. The invention is useful for test marketing of products, advertisements, and reduces advertising costs.

(56) **References Cited**

**U.S. PATENT DOCUMENTS**

3,796,433 A	3/1974	Fraley et al.	
3,848,193 A	11/1974	Martin et al.	..... 325/53
3,987,398 A	10/1976	Fung	..... 325/309
4,166,413 A	9/1979	Meszaros	..... 358/146
4,170,782 A	10/1979	Miller	..... 368/84
4,224,644 A	9/1980	Lewis et al.	..... 360/72.2

(List continued on next page.)

**54 Claims, 14 Drawing Sheets**

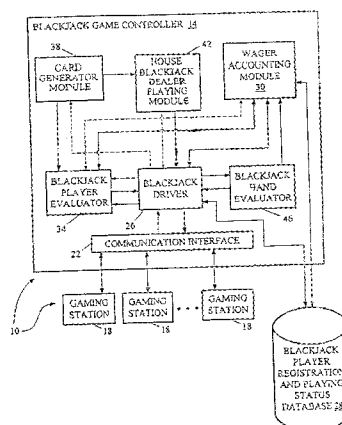

Exhibit A

## US 6,712,702 B2

Page 2

## U.S. PATENT DOCUMENTS

4,283,709 A	8/1981	Lucero et al.	340/147	5,083,271 A	1/1992	Thacher et al.	
4,287,592 A	9/1981	Paulish et al.	370/88	5,093,918 A	3/1992	Heyen et al.	395/725
4,288,809 A	9/1981	Yabe	358/12	5,099,319 A	3/1992	Esch et al.	358/86
4,305,101 A	12/1981	Yarbrough et al.	360/69	5,105,184 A	4/1992	Pirani et al.	340/721
4,307,446 A	12/1981	Barton et al.	364/200	5,133,075 A	7/1992	Risch	395/800
4,338,644 A	7/1982	Staar	360/132	5,141,234 A	8/1992	Boylan et al.	
4,339,798 A	7/1982	Hedges et al.	364/412	5,151,789 A	9/1992	Young	365/194.1
4,347,498 A	8/1982	Lee et al.	340/825.02	5,159,549 A	10/1992	Hallman, Jr. et al.	364/412
4,355,806 A	10/1982	Buck et al.	463/7	5,177,680 A	1/1993	Tsukino et al.	364/401
4,381,522 A	4/1983	Lambert	358/86	5,182,640 A	1/1993	Takano	358/86
4,405,948 A	9/1983	Griffis	358/192.1	5,187,787 A	2/1993	Skeen et al.	395/600
4,429,385 A	1/1984	Cicchelli et al.	370/92	5,200,823 A	4/1993	Yoneda et al.	356/146
4,466,179 A	8/1984	Kasten	358/88	5,220,420 A	6/1993	Hoarty et al.	358/86
4,467,424 A	8/1984	Hedges et al.	364/412	5,220,501 A	6/1993	Lawlor et al.	364/408
4,476,488 A	10/1984	Merrell	358/88	5,220,657 A	6/1993	Bly et al.	395/425
4,494,197 A	1/1985	Troy et al.	364/412	5,224,706 A	7/1993	Bridgeman et al.	273/85
4,528,643 A	7/1985	Freeny, Jr.	364/900	5,227,874 A	7/1993	Von Kohorn	358/84
4,531,187 A	7/1985	Uhland	364/412	5,230,048 A	7/1993	Moy	395/600
4,536,791 A	8/1985	Campbell et al.	358/122	5,231,493 A	7/1993	Apitz	358/146
4,575,579 A	3/1986	Simon et al.	178/4	5,233,533 A	8/1993	Edstrom et al.	364/468
4,602,279 A	7/1986	Freeman	358/86	5,241,465 A	8/1993	Oba et al.	395/158
4,614,342 A	9/1986	Takashima	273/85	5,257,789 A	11/1993	LeVasseur	273/309
4,616,030 A	10/1986	Vincent et al.	364/900	5,257,810 A	11/1993	Schorr et al.	273/292
4,623,122 A	11/1986	Gambetta	340/825.28	5,261,042 A	11/1993	Brandt	396/156
4,636,951 A	1/1987	Harlick	364/412	5,265,033 A	11/1993	Vajk et al.	364/514
4,641,205 A	2/1987	Beyers, Jr.	360/33.1	5,283,639 A	2/1994	Esch et al.	348/6
4,677,466 A	6/1987	Lert, Jr. et al.	358/84	5,283,731 A	2/1994	Lalonde et al.	364/401
4,690,321 A	9/1987	Spaeth	380/20	5,283,734 A	2/1994	Von Kohorn	364/412
4,691,351 A	9/1987	Hayashi et al.	380/10	5,283,856 A	2/1994	Gross et al.	395/51
4,691,354 A	9/1987	Palminteri	360/15	5,285,272 A	2/1994	Bradley et al.	348/6
4,701,794 A	10/1987	Froling et al.	358/147	5,301,028 A	4/1994	Banker et al.	348/570
4,706,121 A	11/1987	Young	358/142	5,305,195 A	4/1994	Murphy	364/401
4,745,468 A	5/1988	Von Kohorn	358/84	5,319,455 A	6/1994	Hoarty et al.	348/7
4,751,578 A	6/1988	Reiter et al.	358/183	5,319,707 A	6/1994	Wasilewski et al.	380/14
4,751,669 A	6/1988	Sturgis et al.	364/800	5,320,356 A	6/1994	Cauda	273/292
4,760,527 A	7/1988	Sidley	364/412	5,321,241 A	6/1994	Craine	235/380
4,768,110 A	8/1988	Dunlap et al.	360/30.1	5,326,104 A	7/1994	Pease et al.	273/138
4,775,935 A	10/1988	Yourick	364/101	5,337,155 A	8/1994	Cornelis	348/473
4,821,102 A	4/1989	Ichikawa et al.	358/183	5,339,239 A	8/1994	Manabe et al.	364/401
4,829,569 A	5/1989	Seth-Smith et al.	380/10	5,343,239 A	8/1994	Lappington et al.	348/12
4,842,275 A	6/1989	Tsatskin	273/1 R	5,343,300 A	8/1994	Hennig	348/478
4,845,739 A	7/1989	Katz	379/92	5,345,594 A	9/1994	Tsuda	455/18
4,856,787 A	8/1989	Itkis	273/237	5,347,632 A	9/1994	Filepp et al.	395/200
4,868,866 A	9/1989	Williams, Jr.	380/49	5,351,970 A	10/1994	Fioretti	273/439
4,873,662 A	10/1989	Sargent	364/900	5,353,218 A	10/1994	De Lapa et al.	364/401
4,875,164 A	10/1989	Monfort	364/412	5,355,480 A	10/1994	Smith et al.	395/600
4,876,592 A	10/1989	Von Kohorn	358/84	5,357,276 A	10/1994	Banker et al.	348/7
4,891,011 A	1/1990	Cook	358/141	5,377,354 A	12/1994	Scannell et al.	395/650
4,902,020 A	2/1990	Auxier	273/256	5,381,393 A	1/1995	Ohtani	395/650
4,906,707 A	3/1990	Yukimoto et al.	358/147	5,393,067 A	2/1995	Paulsen et al.	273/292
4,908,713 A	3/1990	Levine	385/335	5,398,932 A	3/1995	Eberhardt et al.	273/138 A
4,926,255 A	5/1990	Von Kohorn	358/84	5,403,015 A	4/1995	Forte et al.	273/304
4,926,327 A	5/1990	Sidley	364/412	5,404,505 A	4/1995	Levinson	395/600
4,974,149 A	11/1990	Valenti	364/200	5,414,773 A	5/1995	Handelman	380/49
4,975,904 A	12/1990	Mann et al.	370/85.1	5,426,594 A	6/1995	Wright et al.	364/514 R
4,975,905 A	12/1990	Mann et al.	370/85.1	5,428,606 A	6/1995	Moskowitz	370/60
4,977,455 A	12/1990	Young	358/142	5,429,361 A	7/1995	Raven et al.	273/138 A
4,987,486 A	1/1991	Johuson et al.	358/86	5,431,407 A	7/1995	Hofberg et al.	273/292
4,992,940 A	2/1991	Dworkin	364/401	5,434,978 A	7/1995	Dockter et al.	385/200
4,994,908 A	2/1991	Kuban et al.	358/68	5,437,462 A	8/1995	Breeding	273/292
5,001,554 A	3/1991	Johnson et al.	368/86	5,440,262 A	8/1995	Lum et al.	345/212
5,008,853 A	4/1991	Bly et al.	364/900	5,442,771 A	8/1995	Filepp et al.	395/660
5,009,429 A	4/1991	Auxier	273/240	5,471,629 A	11/1995	Risch	395/800
5,034,807 A	7/1991	Von Kohorn	358/84	5,483,466 A	1/1996	Kawahara et al.	364/514 C
5,038,022 A	8/1991	Lucero	235/380	5,498,003 A	3/1996	Gechter	273/434
5,057,915 A	10/1991	Von Kohorn	358/84	5,504,675 A	4/1996	Cragun et al.	364/401
5,058,108 A	10/1991	Mann et al.	370/65.1	5,505,449 A	4/1996	Eberhardt et al.	273/138 A
5,073,931 A	12/1991	Audebert et al.	380/23	5,507,491 A	4/1996	Gatto et al.	273/139
5,075,771 A	12/1991	Hashimoto	358/84	5,508,731 A	4/1996	Kohorn	348/1
5,077,607 A	12/1991	Johnson et al.	358/86	5,511,160 A	4/1996	Robson	395/162
				5,515,098 A	5/1996	Carles	348/8

## US 6,712,702 B2

Page 3

5,526,035 A	6/1996	Lappington et al. ....	348/13	5,722,418 A	3/1998	Bro .....	128/732
5,526,427 A	6/1996	Thomas et al. ....	360/20	5,724,091 A	3/1998	Freeman et al. ....	348/13
5,528,490 A	6/1996	Hill .....	364/600	5,724,106 A	3/1998	Autry et al. ....	348/734
5,532,923 A	7/1996	Sone .....	364/138	5,724,424 A	3/1998	Gifford .....	380/24
5,537,586 A	7/1996	Amram et al. ....	395/148	5,724,425 A	3/1998	Chang et al. ....	380/25
5,539,450 A	7/1996	Handelman .....	348/12	5,729,212 A	3/1998	Martin .....	340/870.28
5,539,822 A	7/1996	Lett .....	380/20	5,729,279 A	3/1998	Fuller .....	348/8
5,544,892 A	8/1996	Breeding .....	273/292	5,732,338 A	3/1998	Schwob .....	455/158.5
5,549,300 A	8/1996	Sardarian .....	273/292	5,732,949 A	3/1998	Josephs .....	273/292
5,557,658 A	9/1996	Gregorek et al. ....	379/67	5,734,589 A	3/1998	Kostreski et al. ....	364/514 A
5,557,721 A	9/1996	Fite et al. ....	395/148	5,734,853 A	3/1998	Hendricks et al. ....	395/352
5,559,312 A	9/1996	Lucero .....	235/380	5,735,525 A	4/1998	McCrea, Jr. ....	273/309
5,561,707 A	10/1996	Katz .....	379/88	5,735,742 A	4/1998	French .....	463/25
5,569,082 A	10/1996	Kaye .....	463/17	5,740,369 A	4/1998	Yokozawa et al. ....	395/200.47
5,572,643 A	11/1996	Judson .....	395/793	5,740,549 A	4/1998	Reilly et al. ....	705/14
5,576,951 A	11/1996	Lockwood .....	395/227	5,746,656 A	5/1998	Bezick et al. ....	463/42
5,577,266 A	11/1996	Takahisa et al. ....	455/66	5,748,742 A	5/1998	Tisdale et al. ....	380/49
5,579,537 A	11/1996	Takahisa .....	455/66	5,749,735 A	5/1998	Redford et al. ....	434/307
5,581,479 A	12/1996	McLaughlin et al. ...	364/614 A	5,749,785 A	5/1998	Rossides .....	463/25
5,583,563 A	12/1996	Wanderscheid et al. ....	348/9	5,751,338 A	5/1998	Ludwig, Jr. ....	348/17
5,585,866 A	12/1996	Miller et al. ....	348/731	5,752,160 A	5/1998	Dunn .....	455/5.1
5,586,257 A	12/1996	Perlman .....	463/42	5,755,621 A	5/1998	Marks et al. ....	463/42
5,586,766 A	12/1996	Forte et al. ....	273/309	5,759,101 A	6/1998	Von Kohorn .....	463/40
5,586,936 A	12/1996	Bennett et al. ....	463/25	5,767,894 A	6/1998	Fuller et al. ....	348/6
5,589,892 A	12/1996	Knee et al. ....	348/731	5,768,382 A	6/1998	Schneier et al. ....	380/23
5,592,212 A	1/1997	Handelman .....	348/12	5,770,533 A	6/1998	Franchi .....	463/42
5,593,349 A	1/1997	Miguel et al. ....	463/30	5,774,591 A	6/1998	Black et al. ....	382/236
5,597,162 A	1/1997	Franklin .....	273/292	5,774,664 A	6/1998	Hidary et al. ....	395/200.48
5,597,307 A	1/1997	Redford et al. ....	434/118	5,774,869 A	6/1998	Toader .....	705/10
5,600,364 A	2/1997	Hendricks et al. ....	348/1	5,779,242 A	7/1998	Kaufmann .....	273/459
5,600,366 A	2/1997	Schulman .....	348/9	5,779,549 A	7/1998	Walker et al. ....	463/42
5,603,502 A	2/1997	Nakagawa .....	273/292	5,781,245 A	7/1998	Van Der Weij et al. ....	348/563
5,610,653 A	3/1997	Abecassis .....	348/110	5,781,246 A	7/1998	Alten et al. ....	348/569
5,611,730 A	3/1997	Weiss .....	463/20	5,787,156 A	7/1998	Katz .....	379/93.13
5,613,190 A	3/1997	Hylton .....	455/3.1	5,788,507 A	8/1998	Redford et al. ....	434/307
5,613,191 A	3/1997	Hylton et al. ....	455/3.1	5,788,574 A	8/1998	Ornstein et al. ....	463/25
5,613,912 A	3/1997	Slater .....	463/25	5,789,892 A	8/1998	Takei .....	318/687
5,617,565 A	4/1997	Augenbraun et al. ....	395/604	5,791,991 A	8/1998	Small .....	463/41
5,624,265 A	4/1997	Redford et al. ....	434/307	5,793,413 A	8/1998	Hylton et al. ....	348/12
5,624,316 A	4/1997	Roskowski et al. ....	463/45	5,794,210 A	8/1998	Goldhaber et al. ....	705/14
5,630,204 A	5/1997	Hylton et al. ....	455/3.3	5,795,156 A	8/1998	Redford et al. ....	434/118
5,635,979 A	6/1997	Kostreski et al. ....	348/13	5,796,945 A	8/1998	Tarabella .....	395/200.9
5,638,426 A	6/1997	Lewis .....	379/90	5,798,785 A	8/1998	Hendricks et al. ....	348/1
5,640,193 A	6/1997	Wellner .....	348/7	5,799,267 A	8/1998	Siegel .....	704/1
5,643,088 A	7/1997	Vaughn et al. ....	463/40	5,800,268 A	9/1998	Molnick .....	463/40
5,659,350 A	8/1997	Hendricks et al. ....	348/6	5,802,220 A	9/1998	Black et al. ....	382/276
5,659,793 A	8/1997	Escobar et al. ....	395/807	5,805,154 A	9/1998	Brown .....	345/327
5,660,366 A	8/1997	Palmer .....	348/9	5,809,481 A	9/1998	Baron et al. ....	705/14
5,660,391 A	8/1997	Klasee .....	273/292	5,809,482 A	9/1998	Strisower .....	705/30
5,664,948 A	9/1997	Dimitriadis et al. ....	343/307 R	5,812,769 A	9/1998	Graber et al. ....	395/200.12
5,669,817 A	9/1997	Tarantino .....	463/13	5,815,551 A	9/1998	Katz .....	379/88
5,675,752 A	10/1997	Scott et al. ....	395/333	5,816,918 A	10/1998	Kelly et al. ....	463/16
5,679,077 A	10/1997	Pocock et al. ....	463/19	5,818,438 A	10/1998	Howe et al. ....	345/327
5,684,863 A	11/1997	Katz .....	379/88	5,823,879 A	10/1998	Goldberg et al. ....	463/42
5,684,918 A	11/1997	Abecassis .....	386/83	5,828,734 A	10/1998	Katz .....	379/93.13
5,687,331 A	11/1997	Volk et al. ....	395/327	5,830,067 A	11/1998	Graves et al. ....	463/40
5,687,971 A	11/1997	Khaladkar .....	273/269	5,830,068 A	11/1998	Brenner et al. ....	463/42
5,688,174 A	11/1997	Kennedy .....	463/37	5,831,527 A	11/1998	Jones, II et al. ....	340/540
5,689,431 A	11/1997	Rudow et al. ....	364/449.7	5,835,126 A	11/1998	Lewis .....	348/9
5,697,844 A	12/1997	Von Kohorn .....	463/40	5,839,725 A	11/1998	Conway .....	273/244
5,702,104 A	12/1997	Malek et al. ....	273/292	5,839,905 A	11/1998	Redford et al. ....	434/307 R
5,702,305 A	12/1997	Norman et al. ....	463/42	5,848,396 A	12/1998	Gerace .....	705/10
5,707,287 A	1/1998	McCrea, Jr. ....	463/27	5,848,397 A	12/1998	Marsh et al. ....	705/14
5,708,780 A	1/1998	Levergood et al. ....	395/200.12	5,851,149 A	12/1998	Kidos et al. ....	463/42
5,708,845 A	1/1998	Wistendahl et al. ....	395/806	5,857,911 A	1/1999	Fioretti .....	463/40
5,709,603 A	1/1998	Kaye .....	463/17	5,867,700 A	2/1999	Ohkura et al. ....	380/20
5,711,715 A	1/1998	Ringo et al. ....	473/9	5,871,398 A	2/1999	Schneier et al. ....	463/16
5,713,574 A	2/1998	Hughes .....	273/292	5,875,108 A	2/1999	Hoffberg et al. ....	364/146
5,713,795 A	2/1998	Kohorn .....	463/17	5,879,233 A	3/1999	Stupero .....	463/11
5,717,860 A	2/1998	Graber et al. ....	395/200.12	5,880,769 A	3/1999	Nemirofsky et al. ....	348/12
5,718,431 A	2/1998	Ornstein .....	273/292	5,885,158 A	3/1999	Torango et al. ....	463/27

US 6,712,702 B2

Page 4

5,898,762	A	4/1999	Katz	379/93.12
5,901,246	A	5/1999	Hoffberg et al.	382/209
5,901,287	A	5/1999	Bull et al.	395/200.48
5,903,317	A	5/1999	Sharir et al.	348/589
5,911,582	A	6/1999	Redford et al.	434/307
5,916,024	A	6/1999	Von Kohorn	463/40
5,917,725	A	6/1999	Thacher et al.	364/410.1
5,917,893	A	6/1999	Katz	379/93.02
5,918,213	A	6/1999	Bernard et al.	705/26
5,933,811	A	8/1999	Angles et al.	705/14
5,934,004	A	8/1999	Koe	463/40
5,937,163	A	8/1999	Lee et al.	395/200.48
5,948,061	A	9/1999	Merriman et al.	709/219
5,957,695	A	9/1999	Redford et al.	434/307
5,964,463	A	10/1999	Moore, Jr.	273/274
5,971,397	A	10/1999	Miguel et al.	273/371
5,987,498	A	11/1999	Athing et al.	709/203
5,990,927	A	11/1999	Hendricks et al.	348/6
5,996,006	A	11/1999	Speicher	709/218
5,999,808	A	12/1999	LaDue	455/412
6,005,561	A	12/1999	Hawkins et al.	345/327
6,025,837	A	2/2000	Matthews, III et al.	345/327
6,035,021	A	3/2000	Katz	379/93.12
6,038,554	A	3/2000	Vig	705/400
6,081,750	A	6/2000	Hoffberg et al.	700/17
6,085,256	A	7/2000	Kitano et al.	709/303
6,154,207	A	11/2000	Farris et al.	345/328
6,183,366	B1	2/2001	Goldberg et al.	463/42
6,208,805	B1	3/2001	Abecassis	386/126
6,236,360	B1	5/2001	Rudow et al.	342/357.13
6,240,555	B1	5/2001	Shoff et al.	725/110
6,264,560	B1	7/2001	Goldberg et al.	463/42
6,289,319	B1	9/2001	Lockwood	705/35
6,323,894	B1	11/2001	Katz	348/15
6,330,021	B1	12/2001	Devaux	348/14.04
6,335,965	B1	1/2002	Katz	379/93.12
6,349,134	B1	2/2002	Katz	379/92.01
6,446,919	B1	9/2002	Tsui	455/6.2

FOREIGN PATENT DOCUMENTS

EP	0 566 454	A1	8/1993	.....	H04N/7/087
EP	680173		11/1995		
EP	680235		11/1995		
EP	0 697 613	A2	2/1996	.....	G02B/27/01
EP	0 843 272	A1	5/1998	.....	G06F/19/00
EP	0 871 132	A1	10/1998	.....	G06F/15/28
EP	1 126 715	A2	8/2001	.....	H04N/7/173
EP	0 688 489	B1	11/2001	.....	H04N/7/14
GB	2 034 995	A	10/1979	.....	H03J/7/185
GB	2 141 907	A	1/1985		
GB	2 183 882		6/1987	.....	G07F/17/34
GB	2 186 670	A	7/1987		
GB	2 205 188		11/1988	.....	G07F/17/34
GB	2 207 314		1/1989	.....	G11B/15/02
GB	2 256 549		9/1992	.....	H04N/5/762
GB	2 281 434	A	3/1995	.....	G10H/1/00
JP	64-18380		1/1989	.....	H04N/7/08
JP	320459		1/1990	.....	H04L/29/06
JP	6314184		4/1993	.....	G06F/3/14
WO	WO 88/04507		6/1988	.....	H04N/7/087
WO	WO 90/07844		7/1990	.....	H04N/05/782
WO	WO 92/12488		7/1992	.....	G06F/15/20
WO	WO 93/09831		5/1993	.....	H04N/1/00
WO	WO 93/19427		9/1993	.....	G06F/15/21
WO	WO 94/14281		6/1994	.....	H04N/7/16
WO	WO 95/31069		11/1995	.....	H04N/7/087
WO	WO 96/30664		10/1996	.....	G06K/13/00
WO	WO 96/36141		11/1996	.....	H04H/1/00

OTHER PUBLICATIONS

U.S. patent application Ser. No. 09/140,979, Goldberg et al., filed Aug. 27, 1998.

U.S. patent application Ser. No. 08/299,620, Auxier et al., filed Sep. 2, 1994.

Advertising brochure for "Trak-21", by Digital Biometrics, Inc., Gaming Division, 5600 Rowland Road, Minnetonka, MN 55343.

Advertising page for "Tracker-Plus TP-700 Player Tracking Equipment for Table Games", by Open Technologies, 6520 Platt Ave., Suite 672, West Hills, CA 91307.

Advertising pages (15-16 and Order Form) for QQP game s, in eStrategy Plus, believed to be from 1994.

Estavanik, "Designing On-Line, Multiplayer Games", in Game Developer, pp. 14-21, Premier 1994.

Horton, "The Power of ImaginNation", in Advertising Age, Mar. 7, 1994.

Information sheet for "Action Tracker Electronic Voucher System".

Marketing Plan for Manifest Destiny, Inc., 1994.

O'Connell, "Advertisers Get Benched", Promo, The International Magazine for Promotion Marketing, p. 96, Mar. 1994.

"PAPA 5"; Feb. 1995; <http://www.ece.umd.edu/~dstewart/pinball/PAPAS/guide.txt>.

"PAPA 6, 1998 World Pinball Championships"; Feb. 1998; <http://www.glue.umd.edu/~dstewart/pinball/PAPA6/>.

"Archive of Pervious Versions of My Home Page"; *Free Software Humor & Jokes Personal*; version 3. mid, Oct. 1996 to present; 2 pgs.

"Cash is the Riddler's Draw"; Jun. 8, 1995; 1 pg.

"Free Software & Tips"; *Free Software Humor & Jokes Personal*; date unknown; 4 pgs.

"List of Some of Rajiv's Technology Related Work"; *Home Free Software Humor & Jokes Personal*; date unknown; 5 pgs.

Resnick; "WWW>Rotating Sponsorship Banner on WWW Pages"; *Net-Happenings Moderator*; Oct. 28, 1995; 2 pgs.

"MARKETING: Ads Delivered In Real Time"; *Northern Light Technology, LLC*; 1997-2002; 2 pgs.

"Licence for Ronald A. Katz Technology Licensing L.P. Patents obtained by HP"; *PR News*; Mar. 18, 2002; 4 pgs.

Levitz; "Tallahassee free-net: The Keystone of a Florida Network of Community Information Systems"; *Journal of Educational Media and Library Science*; Summer 1994; 31(4); pp. 364-373.

Abecassis; U.S. Publication No. 2001/0041053A1 Entitled "Content-On Demand Advertisement System"; published Nov. 15, 2001.

Yan et al.; "SIFT: A Tool for Wide-Area Information Dissemination"; *USENIX Technical Conference*; Jan. 16-20, 1995; pp. 117-186.

Millison, "Games People Play"; *Daily Spectrum*, Jun. 9, 1995; 7 pgs.

"MARKETING: Ads Delivered in Real Time"; *Business Communications Company, Inc.*; Jan. 1996; 2 pages.

"Notification of Transmittal of International Preliminary Examination Report" dated Jan. 25, 2001 for International patent application Ser. No. PCT/US99/25131 with an international date of Oct. 26, 1999, and a priority date of Oct. 26, 1998.

## US 6,712,702 B2

Page 5

- "Written Opinion" dated Aug. 16, 2000 for International patent application Ser. No. PCT/US99/25131 with an international filing date of Oct. 26, 1999, and a priority date of Oct. 26, 1998.
- "Notification of Transmittal of the International Search Report or the Declaration" dated Jan. 31, 2000 for International patent application Ser. No. PCT/US99/25131 with an international filing date of Oct. 26, 1999, and a priority date of Oct. 26, 1998.
- "Notification of Transmittal of International Preliminary Examination Report" dated Jan. 12, 1998 for International patent application Ser. No. PCT/US99/00872 with an international filing date of Jan. 17, 1997, and a priority date of Jan. 19, 1996.
- "Notification of Transmittal of the International Search Report or the Declaration" dated May 12, 1997 for International patent application Ser. No. PCT/US97/00872 with an international filing date of Jan. 17, 1997, and a priority date of Jan. 19, 1996.
- "Licence for Ronald A. Katz: Technology Licensing LP. Patents Obtained by MP" *PR New*; Mar. 18, 2002, 4 pages.
- 24/7 Media Prospectus, Aug. 13, 1998, pp. 1-43
- A component and communication model for push systems, presented at ESEC/FSE 00 -Joint 7th European Software Engineering Conference 7th SIGSOFT International Symposium on the Foundations of So, Sep. 6-10, 1999, Toulouse, France, file:///J/13367/-2/references/references(General)push systems.htm.
- "A Newspaper with a Difference On The Internet"; *Direct Marketing Magazine*, Mar. 1995, 57(11); p. 11.
- Abate; "Advertising Sponsorship is Growing on the Internet"; *Bacon's*, Jul. 1, 1995, News clipping.
- Abate; "Major Deal To Map Internet Future"; *San Francisco Examiner*, Dec. 12, 1996; 1 page.
- Abecassis; U.S. Publication No. 2001/0041053A1 Entitled "Content-On Demand Advertisement System"; published on Nov. 15, 2001.
- Abrahams; "Patent Office May Hinder Hopping of Bunny Across Computerscreens"; *Washington Times*, 1997; 2 pages.
- Abstracts from files in info-mec/comm/net/web Aug. 16, 1996, file:///33671-2/references/general/email/95-96.htm
- "Ad-Free" Information Week, n. 614, pp. 68, 70, Jan. 20, 1997, Dialog Accession No. 5498711 in Dialog @File 2.
- ADMedium Newsletter, Dec. 1, 1996. file:///J/13367/-2/reference/reference.../ADMedium Newsletter (DEC 96 Riddle).htm.
- "Adobe Systems and PicturWeb from alliance -provide consumers with unique digital photo offering" Business Wire Jan. 4, 1996, Dialog Accession No. 00561 in Dialog @File Jun. 21.
- "ADR introduces electronic meeting scheduler-new ADR/email facility cross time zones and data lines" News Release May 31, 1988, Dialog Accession No. 00192162 in Dialog@File 621.
- Also; "PointCast and Its Wannabes"; *Fortune*; Nov. 25, 1998; 2 pages.
- "An Internet Newcomer is Making Money by Selling Moving Ads as Part of Screen Saver"; *ADMedium Newsletter*, Oct. 1, 1996.
- Andrews; "User Friendly: 'Push' Method Could Be The Next Wave"; *Personal Technology*, Dec. 1, 1996, 1 page.
- "Ariel Resources first quarter results, revenue increases 109 percent of comparable period last year," Business Wire, Feb. 13, 1997, Dialog Accession No. 00736050, In Dialog@File 621.
- Askey; "News You've Asked to Use"; *Mediaweek*, Jun. 12, 1995; 5(24); p. 20.
- "Atrium Software delivers next phase in internet push technology for sales forces" PR Newswire Mar. 11, 1997, Dialog Accession No. 00744818 in Dialog@File 621.
- "BackWeb to provide push technology for Microsoft Internet Explorer 4.0" PR Newswire Mar. 12, 1997, Dialog Accession No. 00746003 in Dialog@File 621.
- Bailey, Steve et al., "A Cautionary Tale In The News", Boston Globe, Aug. 13, 1996, p. D1.
- Bank; "Microsoft Picks On-Line News From PointCast"; *Wall Street Journal*; Dec. 12, 1996, 1 page.
- Banic "Inverted Web; How Net is Becoming More Like Television To Draw Advertiser"; *Wall Street Journal*; Dec. 13, 1996; 3 pages.
- Bama, Ed., "Make Mone On The Internet, Maybe", Vermont Business Magazine, vol. 24, No. 7, Jul., 1996, page 50.
- Barrie et al.; "The World Wide Web As An Instructional Tool"; *Science*; Oct. 18, 1996; 274; pp. 371-372.
- Basch; "Interchange Online Network-The Elements for its Success Are Already in Place"; *Link-Up*, May 1, 1995, 12(3), pp. 8-9; Dialog File 233: Microcomputer Abstracts; 0385575.
- Bates; "Electronic Clipping Service. A New Life for SDIs"; *Online*, Jul. 3, 1994, 18(4); pp. 43-47, 49-5; Dialog File 202: Information Science Abs.; 00184574.
- Bell; The Electronic Scholar's Assistant; *Computer in Libraries*, Oct. 1990; pp. 15-16; Dialog File 61: Lisa; 02087937.
- Berst; "'Push' Products Redefine Internet"; *PC Week*, Nov. 25, 1996; p. 63.
- Bibliografia Utilizzata per la stesura della tesi, http://digilander.lol.it/imesseron/bibliol.htm.
- Birma et al., "Exploiting Virtual Synchrony in Distributed Systems" pp. 123-138 1987.
- Birman et al., "Programming Your Way Out of the Past: ISIS and the Meta Project"; *Sun Technology*, Summer 1969; pp. 90-94.
- "Boeing projects continued airline profitability, traffic growth, rational airline orders," PR Newswire, Mar. 6, 1996, Dialog Accession No. 00586684, Dialog@File 621.
- Borenstein, "Multimedia Electronic Mail; Will the Dream Become a Reality!"; *Communications of the ACM*; Apr. 1991, 34(4), pp. 117-19.
- "Brave New Medium", *Economist*; Jun. 29, 1996; 339(7972); pp. 15-16; UK 17-18.
- Brisbin, "AppleSearch: The Latest Version of Apple's Information-Retrieval Tool Makes a Great Internet Clipping Service"; *MacUser*, Jun. 1, 1995, 11(6), p. 46, Dialog File 233, Microcomputer Abstracts; 0357029.
- Brown; "LapLink Keeps In Touch"; *PC Magazine*; Jan. 7, 1997; p. 60.
- Butterman et al., A Structure for Transportable Dynamic Multimedia Documents, *Usenix*, pp.137-154, 1991.
- Carg et al.; "Ziff-Davis Electronic Information Acquires SandPoint"; *PR Newswire San Francisco*; Mar. 1, 1994; 3 pages.
- "ClariNet & InterestAlert announce push technology... to ClariNet's 200 ISPs and 1.5 millin users" Business Wire Mar. 10, 1997, Dialog Accession No. 00744113 in Dialog @File 621.

## US 6,712,702 B2

Page 6

- Clarke; "Cookies"; *Xamax Consultancy Pty Ltd.*; 1996-2001; pp. 1-10.
- Cleland; "A Gaggle of Web Guides Vies for Ads"; *Advertising Age*; Apr. 17, 1995; News clipping.
- "Clickshare one-built, universal-passwork across... early next year" PR Newswire Sep. 15, 1995, Dialog Accession No. 00544269 in Dialog@File 621.
- "CNET and InCommon announce delivery of News.Com.... for desktop deliver of CNET's popular News.Com content-"Business Wire Mar. 10, 1997, Dialog Accession No. 00744544 in Dialog @File621.
- "CompassSearch Web Server Search and Retrieval Tool Available for Internet Publishers; CompassWare server Adds Value to WWW Sites"; *Business Wire*; Jan. 3, 1996; Dialog 00560996.
- "Comprehensive software directory now available on Newsnet" Aug. 29, 1985, Dialog Accession No. 00115864 in Dialog @File 621.
- Conhalm; "This Year in Review"; *Link-Up*, Nov./Dec. 1996; 13(6); pp. 5, 34.
- Continue Reports -Sep. 1995; file:///J/3367/-2/references-(general)riddler -Sep. 1995; htm.
- Cooperstock et al.; "Why Use a Fishing Line When You Have a Net? An Adaptive Multicast Data Distribution Protocol"; *USENIX Technical Conference*; Jan. 22-26, 1998; pp. 343-352.
- Corcoran; "The Marketers Are On-Lining Up for You: Interactive Ads, Other Gimmicks Kick Off the Internet's New Era" *Bacon's*; Sep. 27, 1996. Newspaper clipping.
- "Data Times Announces Major Ne Search Features; Price Cuts, Search Services & Gateways"; *Database Searcher*, Jun. 1, 1990, 6(5), pp. 27-28; Dialog File 233: Microcomputer Abstracts; 0219625.
- Dateline: Princeton, NJ; Financial Times and The Wall Street Journal Together On Dow Jones News/Retrieval; *Information Today*; Apr. 1, 1995, 12(4); p. 1, Dialog File 233; Microcomputer Abstracts; 0382372.
- Derringer; "Freemark Delays Release of Free E-Mail Until April"; *Bacon 's*; Feb. 19, 1996, pp. 1, 20.
- "Despite summer doldrums, online audience claims 5.6% to 5.52 million" *Information & Interactive Services Report*, Oct. 7, 1994 v. 15, Dialog Accession No. 02544536 in Dialog @File 636.
- "Dial-up electronic media director@at low cost introduced by PR Data Systems" *News Release Fe;b. 10, 1989, p. 1*, Dialog Accession No. 02140932 in Dialog @File 16.
- "Diamond Multimedia ships the first K56Flex modems for Macintosh computer" *Business Wire* Apr. 8, 1997, Dialog Accession No. 00757610 in Dialog @File 621.
- "Diamond Multimedia ships its first 56,000... now available at retail" *Business Wire* Mar. 24, 1997, Dialog Accession No. 00755527 in Dialog @File 621.
- Diebarger, "Browsing The WWW by interacting With a Textual Virtual Environment -A Framework for Experimenting With Navigational Metaphors"; *Hypertext 96*; 1996; pp. 170-179.
- Digital Espresso for Aug. 27, 1996, <http://www.mentorsoft.com/DE/in96027.html>.
- EC2@USC-Digital Commerce Center-Internet Advertising, [wyslwyg/2file:/J/3267/-2/references..merce Center -Internet Advertising.htm](http://wyslwyg/2file:/J/3267/-2/references..merce Center -Internet Advertising.htm).
- Egan; "Online Clipping Services Deliver. Electronic Tools Retrieve Neww You Can USSE"; *PC Today*; Mar. 1, 1995, 9(3), pp. 20-24, Dialog File 233: Microcomputer Abstracts; 0379524.
- Eng; "Bits & Bytes"; *Business Week*; Jul. 29, 1996; No. 3466; p. 68A(1).
- "eWorksl Inc. announces eWatch WebAlert-powerful, comprehensive efficient web site monitoring designed for the corporate user" PR Newswire, Aug. 20, 1996, Dialog Accession No. 00655743 in Dialog@file 621.
- E-mail and voicemail systems. (Evolution of the Paperless Office: Legal Issues Arising out of Technology in the Workplace; part 1). *Employee Relations Law Journal*, Winter 1995, 21, No. 4, 5-36; Dialog Accession No. 08361735 in Dialog@File 148.
- E-Taller's Digest in Gifts & Decorative Accessories. [www.etailersdigest.com](http://www.etailersdigest.com); Aug. 1996.
- Farrow; "A Route To The Internet" *Open Computing*, Jun. 1, 1994, 11(6), pp. 106-107, Dialog File 233: Microcomputer Abstracts; 0351749.
- "Federal Reserve Board and Consumer Credit Intelligence from Business Publishers. Inc. enhances Newsnet database" Jun. 10, 1985, Dialog Accession No. 00116869 in Dialog@File 621.
- Finnie; "Free News You Can Use"; *PCComputing .Com*; 1 page.
- Finnie; "Look, Mal. No. Brower"; *PC Magazine*; Jan. 7, 1997; p. 60.
- "First Floor software brings 'push' technology to both businesses and consumers through deals with Microsoft and America Online" PR Newswire Mar. 13, 1997, Dialog Accession No. 00746694 in Dialog@File 621.
- Flaherty, Francis "Cyberspace Swindles; Old Scams, New Twists," *The New York Times*, Jul. 16, 1994, p. 25.
- "Florida business news service names among "World's Best" Internet newspaper publishers by editor & publishers-" *Business Wire* Apr. 1, 1997, Dialog Accession No. 00753847 in Dialog@File 621.
- Flynn et al.; "The Daily Me; Laying Out Tomorrow's (Electronic) News"; *PC Magazine*; Sep. 14, 1993; 12(15); p. 29(1).
- "ForeFront launches WebWhacker 3.0 -... just got better" PR Newswire Mar. 24, 1997, Dialog Accession No. 00750722 in Dialgo@File 621.
- Forsdick, et al., "Initial Experience with Multimedia Documents in Diamond" pp. 99-113 (ed. H.T. Smith) 1984.
- Frank, Howard, "Telcos and Newspapers must Cooperate To Win," *Networking Management*, vol. 10, No. 7, Jun., 1192, p. 46.
- "Free E-mail Service Launched by FreeMark", *Bacon's*; Oct. 1995; News clipping.
- "French firm unveils first Lotus add-in... and unattended electronic mail" *News Release* Nov. 19, 1987, Dialog Accession No. 00175902 in Dialgo @File 621.
- Fried; "NewsNet: An Offering of Current and Specialized Information"; *Online*; Jul. 1985; 9(4); pp. 99-105.
- Frook; "News to the desktop: Vendors deliver personalized news to users via the Net"; *CommunicationsWeek, Interactive Age*; Apr. 29, 1996; 3 pages.
- Fryxell; "NewsNet Stands Alone-If This Service's 800-Plus Full-Text Industry Newsletters Can't Fill Your Research Needs, Then Nothing Can"; *Link-Up*; Nov. 1, 1994, 11(5), pp. 8-9; Dialog File 233: Microcomputer Abstracts; 0366803.

## US 6,712,702 B2

Page 7

- Gallagher, "Pressing E-mail's Mass-Market Advantage; Printable coupons attached to elec. messages makes 1-1 marketing a possibility" Mill Hollow Corporation, DM News 1995 (Lexis database).
- Gambling Online? You Bet!, file:///3/3367/-2/references/references/general/internetgaming.html, May 3, 1999.
- "Gartner Group announces internet-based advantage service" Business Wire Jan. 2, 1996, Dialog Accession No. 00563106 in Dialog@File 621.
- "GE Debuts GErnie in Europe, Introduces Corporate Clipping, Service"; *Link-Up*; Jun. 1, 1990, 7(3); pp. 1, 12, Dialog File 233: Microcomputer Abstracts; 0219292.
- Geocrawler, The Knowledge Archive, from Tim Maffett Sep. 4, 1996; re: Chime script -and other Chime news.
- Gibson; Skills Count At Network Startup-INS Features Design, Operations Specialists For Hire; *PC Week*; Jan. 23, 1995, 12(3); p. 100; Dialog File 233: Microcomputer Abstract 0373166.
- Gifford et al.; "Boston Community Information System 1987-1988"; *Massachusetts Inst. of Tech., Cambridge, Lab. for Computer Science*; May 1989; p. 250; Dialog File 6: NTIS; 1415753.
- Gifford et al.; "Clipping Service User's Manual (Version 1.2)"; *Massachusetts Inst. Of Tech., Cambridge. Lab. for Computer Science*; Sep. 1987, p. 28, Dialog File 6: NTIS; 1326877.
- Goff, Leslie, "Wash Away Those Job-Hunting Jitters. The Opportunities Are Endless On The Web," *Computerworld*, Oct. 31, 1996, p. 12.
- Goldbert et al.; U.S. Patent Application Ser. No. 09/502,285 Entitled "A Networked System for Presenting Advertising" filed Feb. 11, 2000.
- Goldberg et al.; U.S. Patent Application Ser. No. 09/830,593 Entitled "A Network Advertising System Providing Games and Services" filed Apr. 26, 2001.
- Gutman, "New You Need to Succeed: Electronic Newspapers Boost Your Effectiveness"; *Success*, Mar. 1991, 38(2), p. 12, Dialog File 2: INSPEC; 03905093.
- Haar; "Young Turks Point The Way Offline"; *CyberMedia*; Oct. 14, 1996; 2 pages.
- "Harbinger Corporation Announces TrustedLink INP; The most comprehensive solution for easily building and maintaining a corporate Web site," Business Wire, Mar. 25, 1996, Dialog Accession No. 00595210 in Dialog@File 621.
- Harler; "Distribute Coupons Via E-mail" *Bacon's*; Jan. 1996; News clipping.
- Hassett et al.; "Technical Excellence Online Winner. The PointCast Network"; *PC Magazine Online*; 1996; 1 page.
- Hauss; "Technology Gives Early Warning Of New Breaks"; *Public Relations Journal*, May 1995; pp. 18-22.
- "HFS Incorporated, Century 21 Real Estate Corporation... consumer real-estate information service" Business Wire Jan. 10, 1996, Dialog Accession No. 00564626 in Dialog@File 621.
- Hawkins, "Electronic Advertising On Online Information Systems"; *Online*; Mar. 1994, 18(2); pp. 26-39; Dialog File 15: Abi/Inform; 00836506.
- Heckhart et al.; "Data Services Variety Pack or Single Servings"; *Network World*; Jun. 12, 1995; 4 pages.
- Heywood, "Users Get a Closer Look at Virtual Private Networks -The Lates Monitoring Tools From Service Providers Make Sure Customers Are In The Know About Their Virtual Private Networks"; *Data Communications*; Jun. 1, 1994, 23(9), pp. 85-90, Dialog File 233: Microcomputer Abstracts; 0351803.
- "HFS and Century 21 announce major initiatives... in providing one-stop shopping for consumers," Business Wire, Mar. 12, 1996, Dialog Accession No. 00589418; in Dialog@File 621.
- Hollis, et al.; "Addressing Customers Wireless Data Service Needs"; *Telesis*; Oct. 1995; No. 100; pp. 56-57.
- "Home information videotex services will cost subscribers \$78/mo by 1990, according to Intl Resource Development" VideoPrint, Aug. 10, 1981, p. 7, Dialog Accession No. 00679106 in Dialog@File 16.
- "Home Information videotex services are expected to be widely available... for the use of the new services" News Release Jul. 27, 1981, pp. 1-61, Dialog Accession No. 00659126 in Dialog@File 16.
- "HP Internet Advisor Enhanced to Make Internetwork Testing Quicker and Easier; Window 95, Interface Helps to Isolate Network Problems," Business Wire, Mar. 15, 1996, Dialog Accession No. 00590687, in Dialog@File 621.
- Huang et al., "Multimedia E-mail: the Evolution Approach Based on Adapters"; *Software-Practice and Experience*, 24(9); 785-800 1994.
- Hyland, IAB Advertising ABC's, "Why Internet Advertising?", <http://www.jab.net/advertising/content/adcontent.htm>.
- "IDG books Worldwide, Inc. and Mecklemedia Corporation sign agreement to publish ten new internet/virtual reality books" PR Newswire Apr. 17, 1985, Dialog Accession No. 00514153 in Dialog @File 621.
- "IDG to launch Javaworld on World Wide Web," PR Newswire, Feb. 2, 1996, Dialog Accession No. 00576930, in Dialog @File 621.
- "IFN announces instant news service;... ILX to become first distributor" Business Wire Mar. 18, 1997, Dialog Accession No. 00749159 in Dialog @File 621.
- "Implementing On-Line Couoooning"; *Merchandising /Marketing*, 1996 News clipping.
- "Individual, Inc. elects Michael E. Kolowich as new CEO" News Release, Sep. 3, 1996, Dialog Accession No. 06570702 in Dialog @File 16.
- Individual, Inc., announce agreement to acquire FreeLoader, Inc., News Release Jun. 2, 1996, Dialog Accession No. 06306172 in Dialog @File 18.
- "Individual, Inc. -company report" Investext, May 1, 1996, pp. 1-16, Dialog Accession No. 06289588 in Dialog @File 16.
- "Individual Inc. named breakout company of the year by the information Industry Association "Business Wire Oct. 23, 1995, p. 10231026, Dialog Accession No. 05782514 in Dialog @File 16.
- "Individual, Inc. Files for U.S. Patent"; *PR Newswire*; Jul. 9, 1992.
- "Individual, Inc. Sees Strong Sales, Subscriber Growth"; *Electronic Information Report*, Feb. 24, 1994; 17(8).
- "Information Access Company's 10 online databases to be offered through Mead Data Central services" May 1, 1985, Dialog Accession No. 00117313 in Dialog @File 621.
- "Infoseek delivers personalized, current news via e-mail" PR Newswire Feb. 13, 1997, Dialog Accession No. 00731890 in Dialog @File 621.

## US 6,712,702 B2

Page 8

- "Interest ALERT provides push technology to Island's web site visitors" *Business Wire* Feb. 4, 1997, Dialog Accession No. 00733654 in Dialog @File 621.
- "Intermind 'pushes' 140 New Web Channels, Three Times That of Marimba, Backweb and Ifusion Combined"; *SchwabOnline*; Feb. 6, 1997; 2 pages.
- "Internet Current Awareness Service" *Searcher: Magazine/Database Prof.*, v.3 n.10 p.8(1) Nov./Dec. 1995, Dialog Accession No. 00086120 in Dialog @File 256.
- Internet Marketing Discussion list archive: Re: Rotating sponsor banners ?, Dec. 5, 1995, file:///J/3367/-2/references/references(general)/Re Rotating sponsor banners.htm.
- Internet Marketing Discussion list archive: Rotating sponsor banners ?, Dec. 2, 1995, file:///J/3367-2/references/references(general)/Rotating sponsor banners2.htm.
- Internet Marketing Discussion list archive: Rotating sponsor banners?, Nov. 30, 1995, file:///J/3367/-2 references/references(general) Rotating sponsor banners.htm.
- "Internet study shows push technology takes up significant bandwidth... Sixth International World Wide Web Conference" *Business Wire* Apr. 7, 1997, Dialog Accession No. 00757278 in Dialog @File 621.
- "IRG acquires intertect," *PR Newswire*, Dec. 2, 1996, Dialog Accession No. 00703704, in Dialog @File 621.
- Jackson et al.; "InterMail: A Prototype Hypermedia Mail System"; *Hypertext 91 Proceedings*; Dec. 1991, pp. 405-409.
- "Journalist Delivers Your Own Personalized Newspaper"; *IAC News*; 1997; 1 page.
- "Journalist: Your Personalized Newspaper for CompuServe" *User Guide*, 1994.
- Kirkpatrick, "What's Selling on the Internet"; *Kirkpatrick Enterprises, Inc.*; 1996-2000; pp. 1-36.
- Kramer; "Remote Possibilities; Gateways Let Remote Users Exchange Mail Via Web Browsers"; *PC Week*; Apr. 15, 1996, 13(15): 3 pages; Dialog File 233: Microcomputer Abstracts; 0420777.
- LaRosa, "Marketing Slays The Downsizing Dragon"; *Information Today*; Mar. 1, 1992, 9(3), pp. 58-59, Dialog File 233: Microcomputer Abstracts; 0271126.
- "LaserCard™ enables quiet, high quality printing on IBM system/36 and system/38 midrange computers" *News Release*; Mar. 6, 1988.
- "Leading Newspaper Ramp Up Interactive Advertising Development," *Electronic Marketplace Reports*, vol. 9, No. 4, Feb. 21, 1995, p. 4.
- Levine; "Knowing Where You Browse?"; *comp.society.privacy*, Sep. 21, 1995; pp. 1-5.
- Lewis, Peter H., "The New York Times introduces a Web Site", *The New York Times*, Jan. 22, 1996, p. C7.
- Lexis database, "Individual Launches Newspaper Direct" *PR Newswire* 1996.
- Lexis database; "FreeLoader, Inc. Announces the First Service to Deliver the Internet Offline"; *PR Newswire Association, Inc.*; Jan. 19, 1996; 3 pages.
- Lexis database, "FreeMark Communications and Sports-Ticker enter online sports information distribution agreement; Popular sports content first of a series of innovative content offerings to be delivered free to email users" *Business Wire* 1996.
- Lexis database, "Getting Wilrad With ST"; *Times Newspapers Limited*; Jan. 22, 1995; 1 page.
- Lexis database; "On-Line Mortgage Service Will Operate Over Internet"; *National Thrift News, Inc.*; Oct. 31, 1994; 3 pages.
- Lexis database, "W3.com Introduces first visitor-tracking software for web sites; software increases interactivity, provides powerful tracking and customization features while simplifying web site development" *Business Wire* 1995.
- Lexis database, "Cover Story: free mail, part two; two companies announce free internet e-mail services" *IAC (SM) Newsletter Database (TM), Future Systems, Inc., Multimedia & Videodisc Monitor* 1995.
- Lexis database, "Firm to offer free net mail" *Computerworld* 1995.
- Lexis database, "Productview interactive to launch free email service this year" *IAC (SM) Newsletter Database (TM) M2 Communications, M2 Presswire* 1995.
- Lexis database, "No shortage of online choices" *Mill Hollow Corporation, DM New* 1995.
- "Licence for Ronald A. Katz Technology Licensing I.P. Patents Obtained by HP"; *PR News*; Mar. 18, 2002, 4 pages.
- Lockwood, "All The News That's Fit to Telecommunicate"; *A+The Independent Guide for Apple Computing*, Jun. 1986, 4(6), pp. 93-96; Dialog File 233: Microcomputer Abstracts; 0023714.
- Lu; "Computers Making Impacts in Crosswork Market"; *Crossword Tournament: New York Times*; Aug. 16, 1996.
- "Macromedia's Shockwave brings animation and entertainment to internet push technology" *PR Newswire* Feb. 25, 1997, Dialog Accession No. 00744301 in Dialog @File 621.
- Maddox, "More Hits For Your Web Sites"; *Net Access*; Feb. 26, 1996; News clipping.
- "Madison Avenue's OnLine Leaps" *Newspaper Article*.
- Makulowich: "A Net Explorer's Log"; *Online*; Nov. 1, 1996, 20(6): pp. 40-42; Dialog file 233: Micro-compute Abstracts; 0441925.
- "McAfee announces PC Medic 97 and NetMedic 97;... by proactively preventing common Windows 96 problems"; *Business Wire* Mar. 18, 1997, Dialog Accession No. 00747856 in Dialog @File 621.
- "McAfee launches enterprise SecureCast; first to deliver... McAfee and BackWeb pioneer new software distribution channel" *Business Wire* Feb. 26, 1997, Dialog Accession No. 00740253 in Dialog @File 62.
- "McAfee launches VirusScan 3.0;... detects 100% of viruses in latest secure computing magazine review" *Business Wire* March 3, 1997, Dialog Accession No. 00741540 in Dialog @File 621.
- "McGraw-Hill news available on Dialcom" *News Release* Jul. 27, 1988, Dialog Accession No. 00199385 in Dialog @File 621.
- "MCI Acquires Equifax's Stake in FYI OnLine"; *Electronic Information Report*, Oct. 21, 1994; 15(38).
- "Mead Data Central adds Trinet databases to Exchange™" Jan. 17, 1966, Dialog Accession No. 00120619 in Dialog @File 621.
- "Media tracking service watches cyberspace: RTV offers swatch to monitor internet" *PR Newswire* Feb. 20, 1996, Dialog Accession No. 00581154 in Dialog @File 621.
- Memon; "Free E-mail is Here, But With Ads Aplenty"; *Bacon's*; Jul. 27, 1995; News clipping.
- "Mercury, Center Intros NewsHound Clipping Service"; *Newsbytes Ness Network*; pg. N/A.



## US 6,712,702 B2

Page 9

- "Microsoft products now available through online interactive atOnce software"Business Wire Jan. 15, 1996. Dialog Accession No. 00565507 in Dialog @File 621.
- Miller, "News On-Demand for Multimedia Networks"; *ACM Multimedia*; 1993; pp. 383-392.
- Mitchell, *PC World*, "Two Free Programs Deliver News to Your PC"1996.
- Mohan, "Firm to Offer Free Net Mall"; Jul. 10, 1995; 1 page. (Newspaper Article Clipping).
- Mohan, "Free mail on the net forces users to trade off privacy"; *Computerworld*, Inc., Nov. 27, 1995.
- Nelson; "Information Distribution System: PointCast I-Server Pleases All"; *Info World*; Nov. 16, 1996; pp. IW/3 and IW/8.
- Net Results: Web Marketing That Works... Media: The Many Faces of Web Advertising, wysiwyg://2/file:/J3367/-2/references/references...Ia The Many Faces of Web Advertising.htm.
- "NETdelivery and ICat announce strategic partnership"PR Newswire Feb. 11, 1997, Dialog Accession No. 00733524 in Dialog @File 621.
- "Net delivery announces release of 1.1—a unique push product for the Internet"PR Newswire March 1997, Dialog Accession No. 00744055 in Dialog@File 621.
- "New custom file capability for Nexis"May 1, 1985, Dialog Accession No. 0017314 in Dialog@File 621.
- "New subject group files, pricing for Nexis™"May 1, 1985, Dialog Accession No. 00117268 in Dialog@File 621.
- "News Alert introduce Real-Time Electronic Clipping Service"; *Information Today*, Jun. 1, 1995, 12 (6); p. 14; Dialog @File 233: Microcomputer Abstracts; 0387603
- "News Alert to Introduce Real-Time"Information Today, v. 12 No. 6, p. 14(1), Jun. 1995, Dialog Accession No. 00078844 in Dialog @File 266.
- "Newsday direct available to Prodigy subscribers at no additional fee"Business Wire Oct. 28, 1995, Dialog Accession No. 00543429 in Dialog @File 621.
- "NewsHound Sniffs Out Stories"; *Open Systems Today*; Nov. 28, 1994; No. 164; p. 36.
- "Newsnet and American Business Information present business America —online"News Release Mar. 18, 1993. Dialog Accession No. 00350165 in Dialog @File 621.
- "NewsNet Newly Enhanced NwsFlash"; *Information Today*; Apr. 1, 1990, 7(4); p. 4, Dialog File 233: Microcomputer Abstracts; 0254449.
- "Newsnet offers an electronic news dipping service called NewsFlash"Marketing News, Nov. 25, 1983. p. 23, Dialog Accession No. 00969003.
- "Newsnet to convert online system to PLS search software"PR Newswire Nov. 15, 1994, Dialog Accession No. 00502206 in Dialog @File 621.
- "Newsnet unveils major new enhancements"PR Newswire May 3, 1995, Dialog Accession No. 00616765 in Dialog @File 621.
- "Nexis@adds radio transcripts of Dougherty Daily ad broadcasts"Mar. 11, 1986, Dialog Accession No. 00126985 in Dialog @File 621.
- "N.Y. Times Mno. unveiled World Wide Web site, The New York Times on Web. (Comm Daily Notebook)"Communications Daily, Jan. 23, 1996; v. 16 No. 15, p. 6(2), Dialog Accession No. 08418048 in Dialog @File 148.
- O'Connor; "Ads to Pay for Free E-Mail Service"; *Bacon's*, Jun. 29, 1995; News clipping.
- O'Connor, "Free A-mail Service Stated for the Fall: Limited Urban Areas to Try OUt Advertiser-Supported Messaging Service"; *Business*; Jul. 01, 1995; p. C7 (Lexis Nexis).
- O'Connell; "Turning On To Screen Savers"; *IAC News*; 1997; 2 pages.
- Gjala, "Staying Alert Via Online Clipping Services"; *Online*; Sep. 1991; 15(5), pp. 80-82.
- "Online data push"InformationWeek n. 619, pp. 6-12, 66, 68, Feb. 24, 1997, Dialog Accession No. 5529660 in Dialog @File 2.
- "Online Interactive's FreeShop Online achieves one million electronic orders...."Business Wire, Feb. 7, 1996, Dialog Accession No. 00575091, in Dialog@File 621.
- "On-line software maps DB2 direction"News Release Mar. 27, 1991, Dialog Accession No. 00294253 in Dialgo @File 621.
- "Online-Time, Inc."Report on Electronic Commerce; Nov. 12, 1996; 3(23).
- Overton, *PC World*, "PointCast 1.1: More Content for News Junkies"1997.
- "Paley opens communications consulting firm"PR Newswire Sep. 30, 1983, Dialog Accession No. 01906440 in Dialog @File 148.
- "Patent Office May Minder Hopping of Bunny Across Computerscreens"; *Washington Times*; 1997, 2 pages.
- "Patterns of use, exposure in paper's audiotex system—"Newspaper Research Journal (INRS), 16(1):48-59 1995, Dialog Accession No. 02586508, in Dialog@File 484.
- "PC World Online chooses Lanacom to deliver next generation "push"to mor than half a million monthly line users"Business Wire, Apr. 9, 1997, Dialog Accession No. 00758089 in Dialog@File 621.
- PCN, PointCast, Inc. PointCast 1.0, "we created a splash screen explaining the software," Feb. 1996.
- "PED Deliers Personalized Newspaper To Users Desktops"; *IAC News*; 1987; 2 pages.
- "PED Software introduced Journalist, Software That Allow Users to Retrieve and Print Data From the Prodigy Online Service"; *Newsbytes News Network*; Apr. 5, 1994; Dialog 01014310.
- Pinella et al.; "Individual , Inc. Announced Today Shipment of A New Release Of Its Flagship"; *Businesswire*; Sep. 18, 1995; 2 pages.
- Phillips; "An Interpersonal Multimedia Visualization System"; *IEEE Computer Graphics & Applications*; 1991, pp. 20-27.
- Phillips, "Media View: A General Multimedia Digital Publication System"; *Communications of the ACM*, 34(7): 76-83 1981.
- PointCast unveils free news service —Tech News —CNET—.com, Feb. 13, 1996, file:///J/3367/-2/references/reference...unveils free news service (Feb. 96).htm.
- Postel, et al., Information Sciences Institute, ISI Research Report, "The 1st Experimental Multimedia Mail System"pp. 1-27 1986.
- Prodigy promotion, Read all about the Prodigy interactive personal service of its kind that lets each member of your family personalize it to his or her interest and priorities, 6 pages.
- Ramanathan et al.; "Architectures for Personalized Multimedia"; *IEEE*; 1994; pp. 37-46.

## US 6,712,702 B2

Page 10

- Ramanathan et al., "Towards Personalized Multimedia Dial-Up Services"; *Computer Networks and ISDN Systems*, 26:1305-1322 1994.
- Rapozz: "J-Server: Gotta Have It" *PC Week*; Oct. 28, 1996; 12(43); 1 page.
- Raymond; "Newsflash: Or One Cybrarians's Quest for Electronic News Delivery"; *Special Libraries; Fall 1994*; vol. 85: Issue 4; pp. 270-273.
- Reinheimer; "Information on Demand's Multi-File Electronic Clipping Service"; *National Online Meeting*; New York, NY; May 5-7, 1987.
- Robert Hobbes Zakon, HJobbes Internet Timeline v5.6.-the definitive ARP Arter& Internet history. <http://www.zakon.org/robert/internet/timeline/>.
- Rodriguez; "Real-Time Group Conferencing to Ship"; *News/Networlding*; Oct. 10, 1994; p. 49.
- Roybeal et al.; "Large-Scale Demonstration Test Plan For Digfaco Data Acquisition System"; *Lockhead Idaho Technologies, Co.*; Nov. 1994, p. 40; Dialog File 6: NTIS; 1852842.
- Rudich. "How Customizable Nes Services Can Help You Reduce Clutter (and Guilty)"; *Link-Up*; 1996. 13(5); pp. 8-9; Dialog File 233; Microcomputer Abstract; 0435810. Sample Web page.
- Sanders, *Business Week*, PC Meets the TV; The Plot Thickens, pp. 94-95, 1996.
- "Scala's new CEO brings Madison Avenue and Hollywood perspective to multimedia computer television" PR Newswire Mar. 17, 1997, Dialog Accession No. 00748917 in Dialog @File 621.
- Schoenfeld; "Developers Plan Free E-mail"; *Online Marketplace*; Jun. 1995; 2 pages.
- "Search Services & Gateways"; *Database Searcher*, Jun. 1, 1991, 7(5); pp. 31-33; Dialog File 233: MicroComputer Abstracts; 0242553.
- Seidman's Online Insider for the Week Ending May 3, 1996, vo. 3 No. 18, <http://www.onlineinsider.com/html/archives/050396.html>.
- Eno; "MultiMedia Information Broadcasting Service Present"; *IEEE*, 1994, pp. 117-120.
- Shel@1 blackjacktime.com, e-mail re: Advertising article about CNET, Jan. 17, 2002.
- Shermen, "The Executive's NewsStand NewsNet Can Help Track Your Company's Image Your Company, Your Clients and Your Industry"; *Link-Up*, Mar.1, 1990, 7(2), pp. 20-21; Dialog File 233: Microcomputer Abstracts; 0256018.
- "Slimware announces alliance with intermind to push enterprise data to users desktops" *Business Wire* Mar. 12, 1997, Dialog Accession No. 00748045 in Dialog @File 621.
- "Sky Computer chosen as compute processor for Broadcast Data Systems, Inc." News Release Aug. 24, 1992, Dialog Accession No. 00335658 in Dialog@File 621.
- Slaby; "SendPoint Unveils Hoover NewsAlert For Windows: Powerful Intelligent-Agent Based Software Monitor Provides Real-Time News for Critical Decision Making"; *Businesswire*; Oct. 30, 1995; 2 pages.
- Smith, The World-Wide-Web, Dec. 11, 1995, file:///J/3367/-2/references/references/general/web(Dec.95).htm.
- Soltes, The World-Wide-Web, Dec. 11, 1005, file:///3367/-2/references/references/general/web(Dec.95).htm.
- Soltes; "Catch The Wave"; *Bacon's*; Aug. 16, 1996, News clipping.
- Sponsor of the Day Newsletter Nov. 1996 <http://www.cris.com/~raydaly/sponijnw.html>.
- "StarBurst Communications to bring true "push" technology to the Internet" *Business Wire* Mar. 3, 1997, Dialog Accession No. 00743147 in Dialog @File 621.
- "Starfish Software announces corporated 10-user paks....now available in new money-saving 10-packs" *Business Wire* Feb. 6, 1996, Dialog Accession No. 00574412 in Dialog @File 621.
- "Starfish Software Inc. Introduces "Earth Time"... for online preview and download" *Business Wire* Jan. 23, 1996, Dialog Accession No. 00569318 in Dialog @File 621.
- "Starfish Software first to leverage Sun's Java... Sun's Hot Java and Netscape's Navigator 2.0..." *Business Wire* Nov. 13, 1996, Dialog Accession No. 00545472 in Dialog@File 621.
- "Starfish Software ships Earthtime 2.0; The essential world clock... as a Netscape Navigator 2.0 plug-in," *Business Wire*, Mar. 12, 1996, Dialog Accession No. 00589215, in Dialog @File 621.
- Still; "An Agency's View of Electronic Monitoring", *Journal of the Society of Motion Picture and Television Engineers*, Mar. 1975; 64(3); pp. 172-173; Dialog File 2: INSPEC; 00782712.
- Story et al.; "The RightPages Image-Based Electronic Library for Alerting and Browsing" *IEEE*, Sep. 1992; pp. 17-25.
- "Suddenly Videotex is finding an audience: Boston CitNet... free videotex svcs & charging for advertising" *Business Week*. Oct. 19, 1987, pp. 92, 94 Dialog Accession No. 01784027 in Dialog @File 16.
- "Sun-Sentinel Launches Interactive Real Estate Services on the Internet" PR Newswire, Apr. 11, 1996, Dialog Accession No. 00600800 in Dialog @File 621.
- Tannenbaum; "Patent Approved, Patent Pending"; *Wall Street Journal Interactive Edition*; 1999.
- Targeted ads soon to pop up -Tech News -CNET.com file:///J/3367/-2/references/references...started in 97)Tech News -CNET.com.htm, Feb. 19, 1997.
- "Technology industry & corporate customers push Marimba to the top" PR Newswire Feb. 24, 1997, Dialog Accession No. 00737499 in Dialog@File 621.
- "TechWeb's breaking news and information now "pushed"...techWeb channel keeps..." *Business Wire* Feb. 12, 1997, Dialog Accession No. 00730658 in Dialog @File 621.
- "Tektronix brings embedded-software engineers more tools for decreasing time to market" News Release Apr. 7, 1995, Dialog Accession No. 00516600 in Dialog@File 621.
- "Telebase launches electronic clipping services" PR Newswire May 7, 1991, Dialog Accession No. 00295190 in Dialog @File 621.
- "Telecommunications Information from Phillips Publishing available online through Newsnet" Jun. 12, 1985, Dialog Accession No. 00117476 in Dialog @File 621.
- "The Hook is The Look Of The Journal"; *Business Week*; Aug. 16, 1993; No. 3332; p. 102A.
- The Journal of American Underground Computer. ISSN 1074-3111, vol. 1, Issue 8, Apr. 21, 1995.
- "The Rauters Business Report" Asia-Pacific Business Report Mar. 4, 1996, Dialog Accession No. 2619020, in Dialog @File 611.
- The Sout Report -Apr. 6, 1996, A Publication of Internet Scout Computer Science Department, University of Wisconsin, <http://scout.cs.wise.edu/reopr/sr/1996/scout-960405.html>.

## US 6,712,702 B2

Page 11

- The Scout Report—May 3, 1996; A Publication of Internet Scout Computer Science Department, University of Wisconsin, file:///J/3367/-2/references/references/...a)/The Scout Report—May 3, 1996.htm.
- “The world’s most useful online business library adds full-text archives of The New York Times” Business Wire Oct. 31, 1995, Dialog Accession No. 00543679 in Dialog @File 621.
- “The World Wide Web as a Universal Interface to Government Services”; *Center for Technology in Government, University at Albany*; Project Report 96-2; 1996.
- “Their E-mail Could Become Free Mail”; *Bacon’s*; Jul. 7, 1995; News clipping.
- Thimm; “A Multimedia Enhanced CSCW Teleservice for Wide Area Cooperative Authoring of Multimedia Documents”; *Sigois Bulletin*; Dec. 1994, 15(2); pp. 49-57.
- “Time Warner’s Pathfinder; Compuserve Inc. and Open Markert Inc. Announce a Breakthrough for the Internet.” PR Newsire, Apr. 11, 1996, Dialog Accession No. 00601438 in Dialog @File 621.
- “TMS and Mercury mail to develop personalized internet e-mail products” PR Newswire Jun. 14, 1996, Dialog Accession No. 00628917 in Dialog @File 621.
- TreasureHunt.com—Related Websites, wyswyg:/2/file:/J/3367-2/reference/references/general)/Game Websites.htm.
- Ubols; “New Shades of Blue: IBM’s John Patrick Sees Opportunity For Big Blue All Over The Internet”; *Internet World*; Mar. 1, 1995, 6(3); pp. 62-66, Dialog File 233: Microcomputer Abstracts; 0378621.
- “UCA&L announces new internet divison... to help clients reach, communicate with, and market to customers online,” Business Wire, Mar. 5, 1996, Dialog Accession No. 00586617, in Dialog @File 621.
- “UK: Home Computer From Your Oown Correspondent”; *Reuters Info Svcs.*; 1996; 2 pages.
- Van Kirk; “Lotus Notes Tied to Internet”; *News/Networking*; Oct. 10, 1994, p. 49.
- Value International—Web Projects, file:///J/3367/-2/references/reference... International—Web Projects(96-98).htm.
- “Virtual Dom tops (sic) into real life of students; fully dorm suite puts students live on the Web for all to see,” PR Newswire, Oct. 31, 1995, Dialog Accession No. 00543165, in Dialog@File 61.
- Volokh; “Cheap Speech and What It Will Do”; *Yale Law Journal*; May 1995; 104(7); pp. 1605-1650.
- Waxweb v.2.0, Apr. 3, 1995, file:///J/3367/-2/references/references/general)v/waxweb.v2.0.htm.
- “Web News With A Personal Touch: Individual, Inc. Offers Ad-Backer, Customized Information Source”; *Advertising Age*; Apr. 3, 1995; 68(14); p. 25.
- Web Programming Unleashed, Copyright 1996 by Sams.net Publishing, First edition.
- Webb; “Telebase Launches Clipping Service ECS May Now Be Accessed by Users Directly Through Telebase”; *Link-Up*, May 1, 1991, 6(3); pp. 1 and 39, Dialog File No. 233: Microcomputer Abstracts; 0240805.
- Wildier; “Free E-mail—For A Price”; *Bacon’s*; Nov. 27, 1995; News clipping.
- Wildier; “Get News While Your PC Sleeps”; *Net Access*; Feb. 26, 1996: p. 77; <http://techweb.amp.com>.
- Williamson; This E-mail Message Is Brought to You by...; *Advertising Age*; Apr. 17, 1995, newclipping.
- Winer, “DaveNet”; 1994-2000; pp. 1-8.
- Wireless: Wireless Advertising Gets Support From Consumers, file:///J/3367/-2/references/references/general)/advertising.htm.
- “Yahoo!BackWeb Channel Guide”; *Yahoo Channel Guide: What’s Going On!*; 2 pages.
- Yoshida; “Group Formed To Oversee 1394 Patent Licensing”; *Systems & Software News*; Nov. 23, 1999; pp. 1-3.
- Zakon, Hobbes Internet Timeline Copyright ©1993-2002 <http://www.zakon.org/robert/intenet/timeline>. 24 pages.
- “ZD Net celebrates first year of web advertising program as top-grossing content provider with 63 April Advertisers,” PR Newswire, Apr. 15, 1996, Dialog Accession No. 00602035, in Dialog@File 621.
- Zuckerman; “Microsoft and Pointcast in Broadcast Alliance”; *New York Times*; Dec. 12, 1996; 1 page.
- Zuckermann; “Pushing the Envelope on Delivery of Customized Internet”; *New York Times*; Dec. 9, 1996: 2 pages.

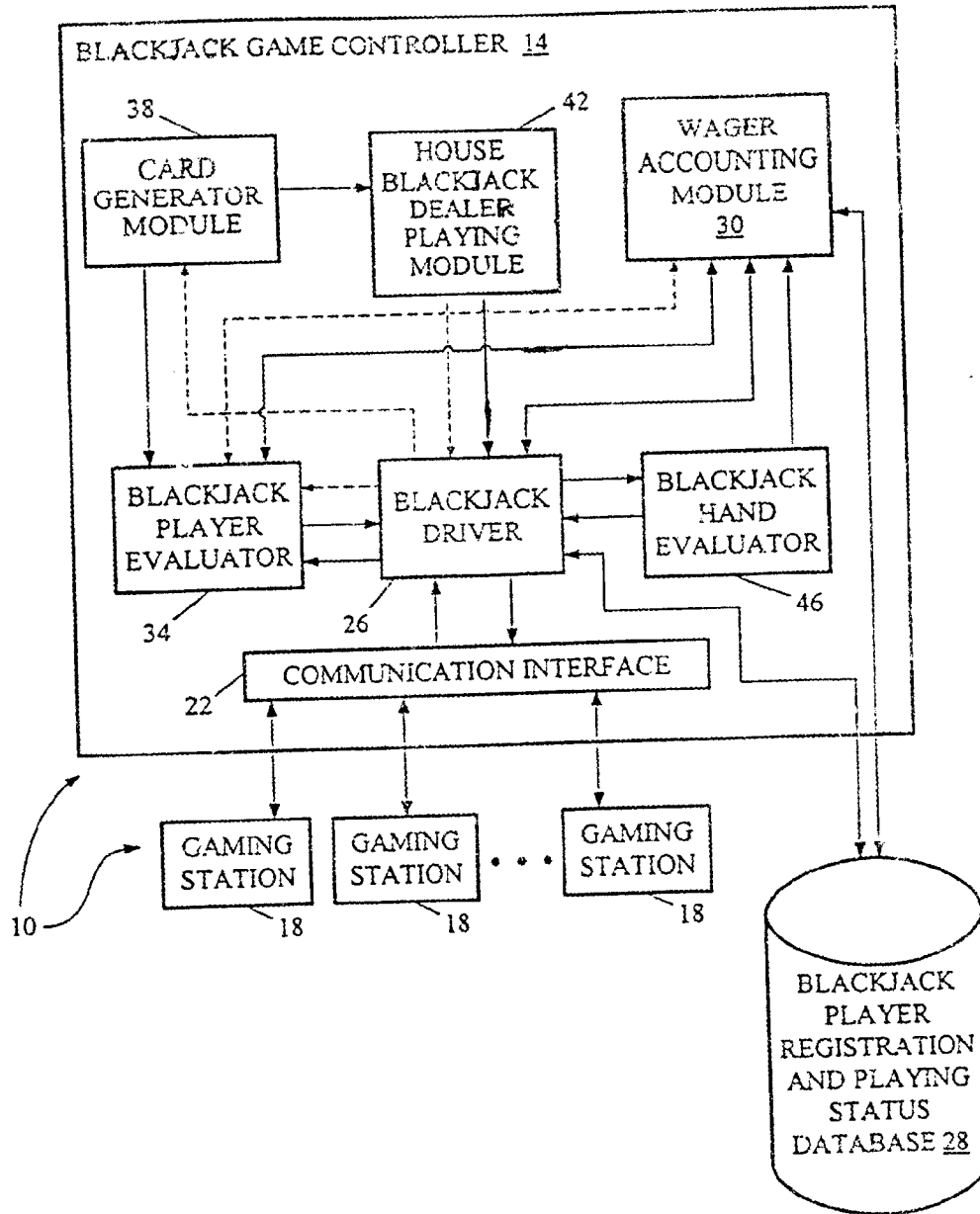

FIG. 1

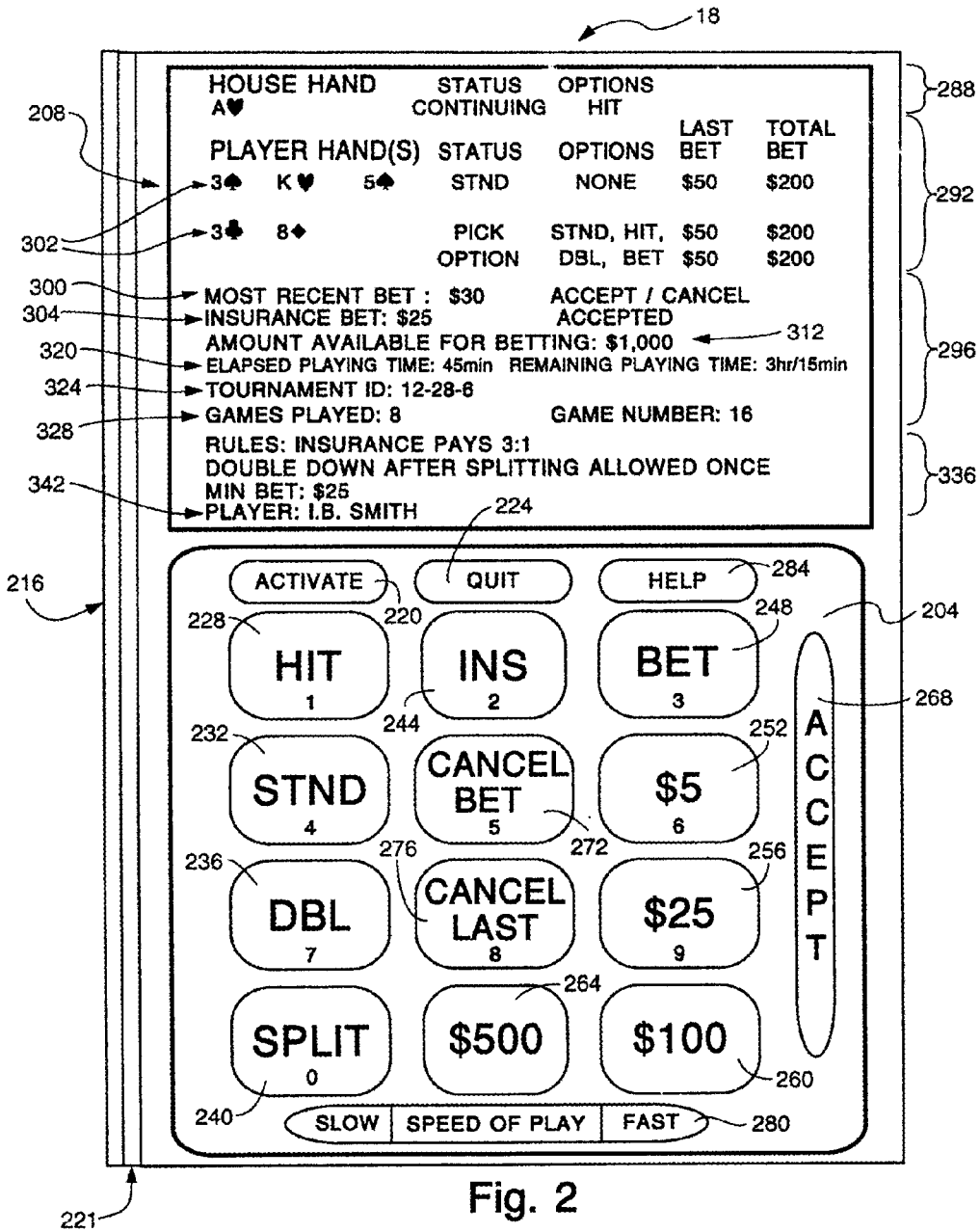

Fig. 2

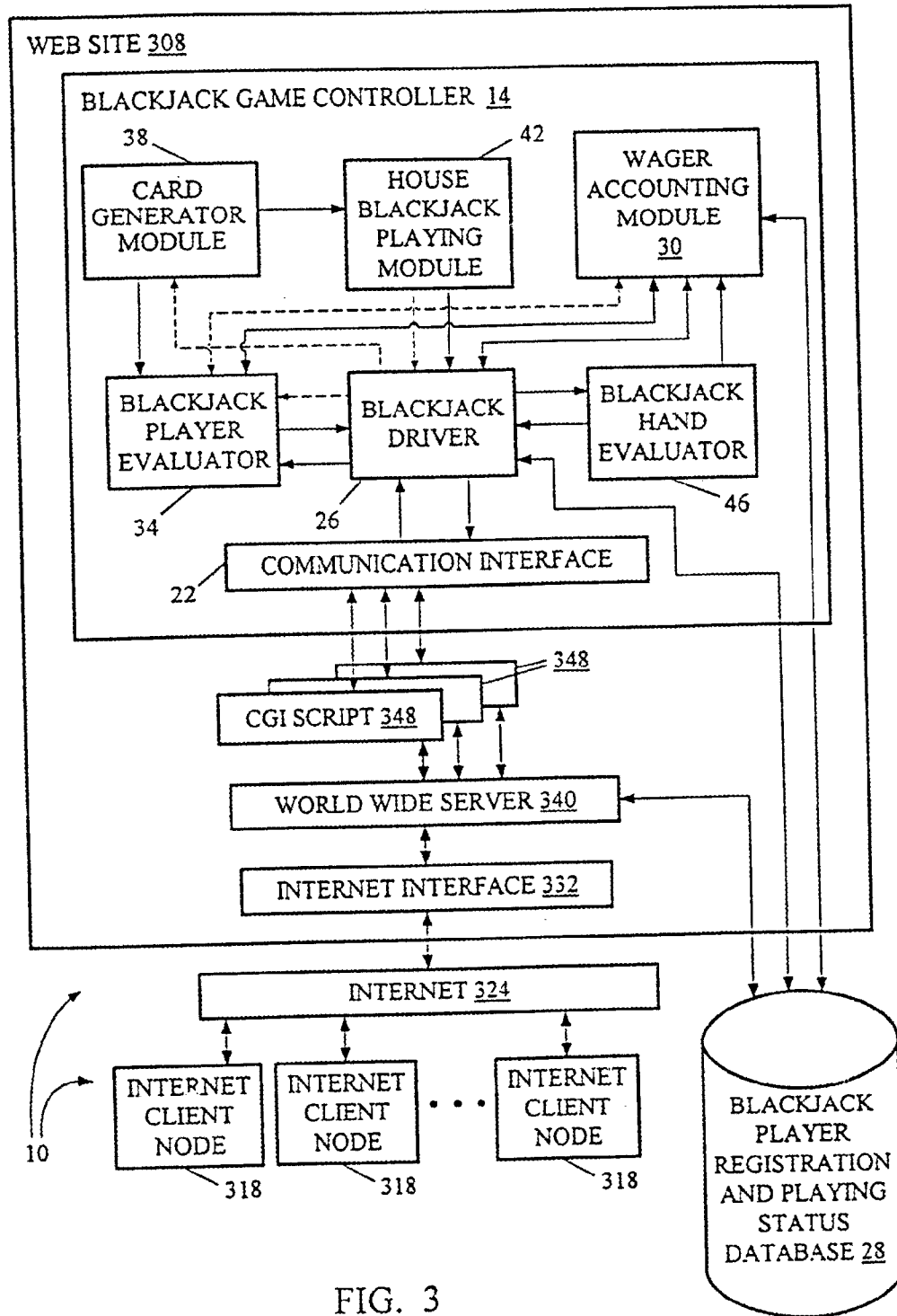
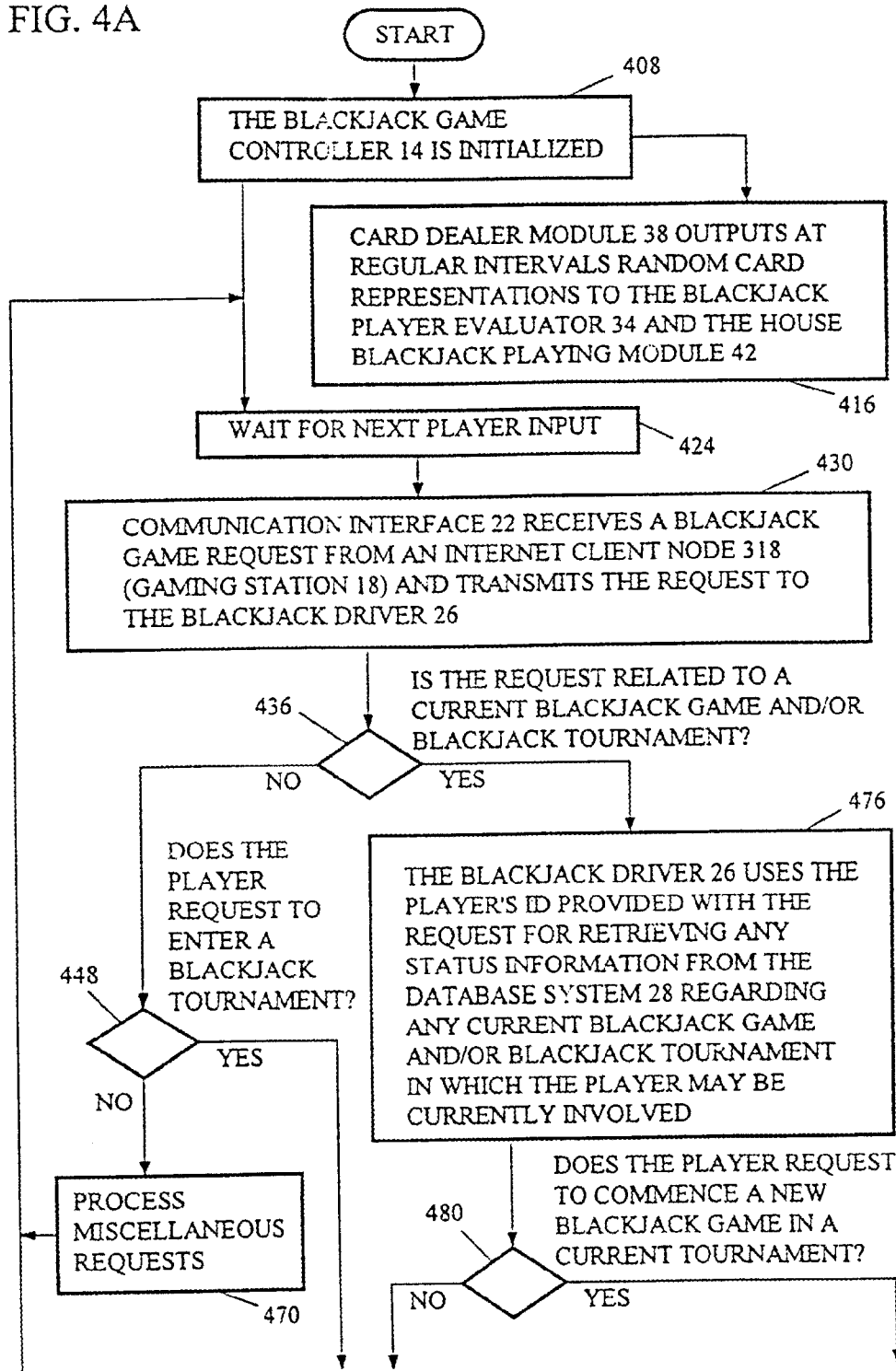

FIG. 3

FIG. 4A



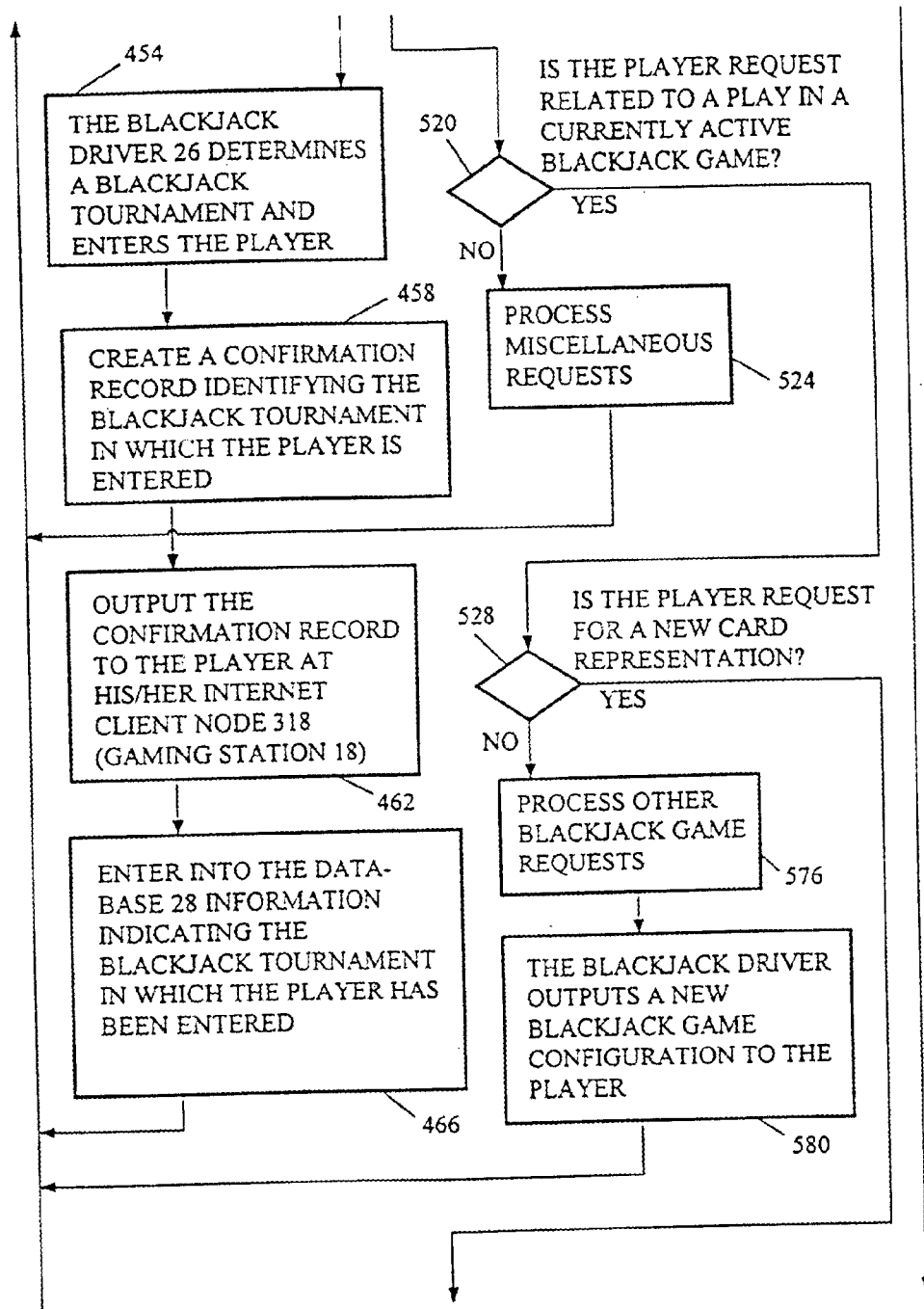

FIG. 4B



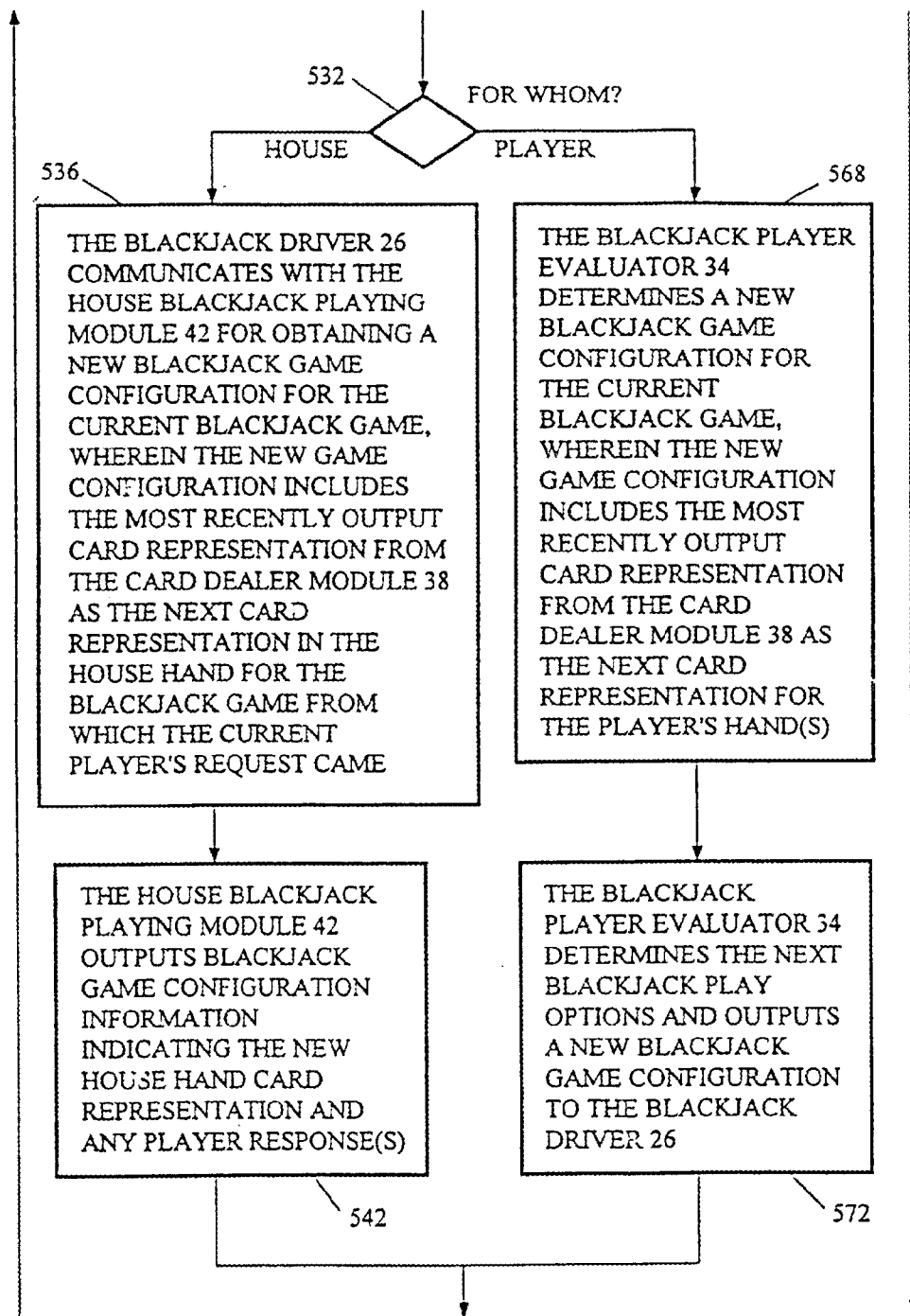

FIG. 4C

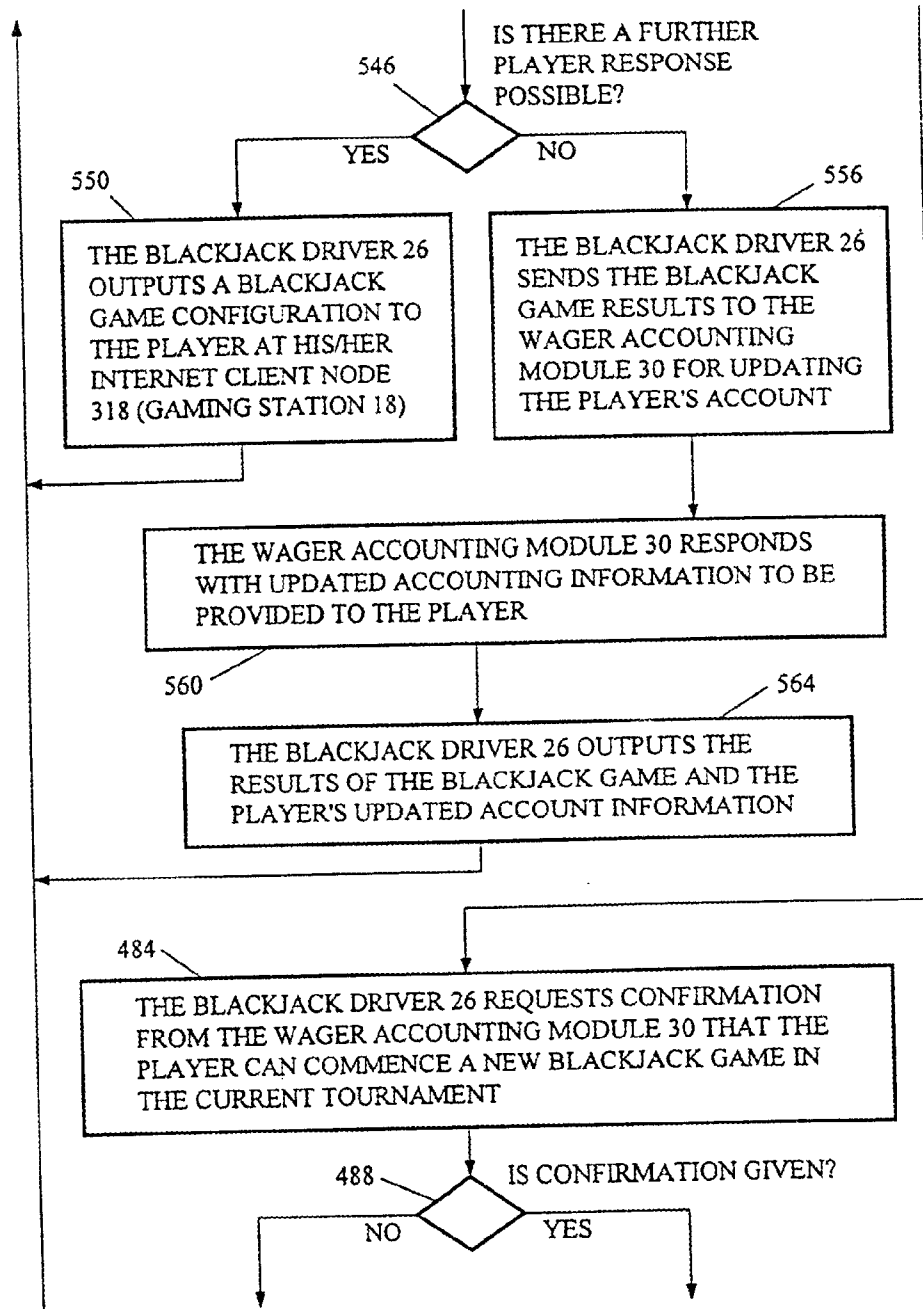

FIG. 4D

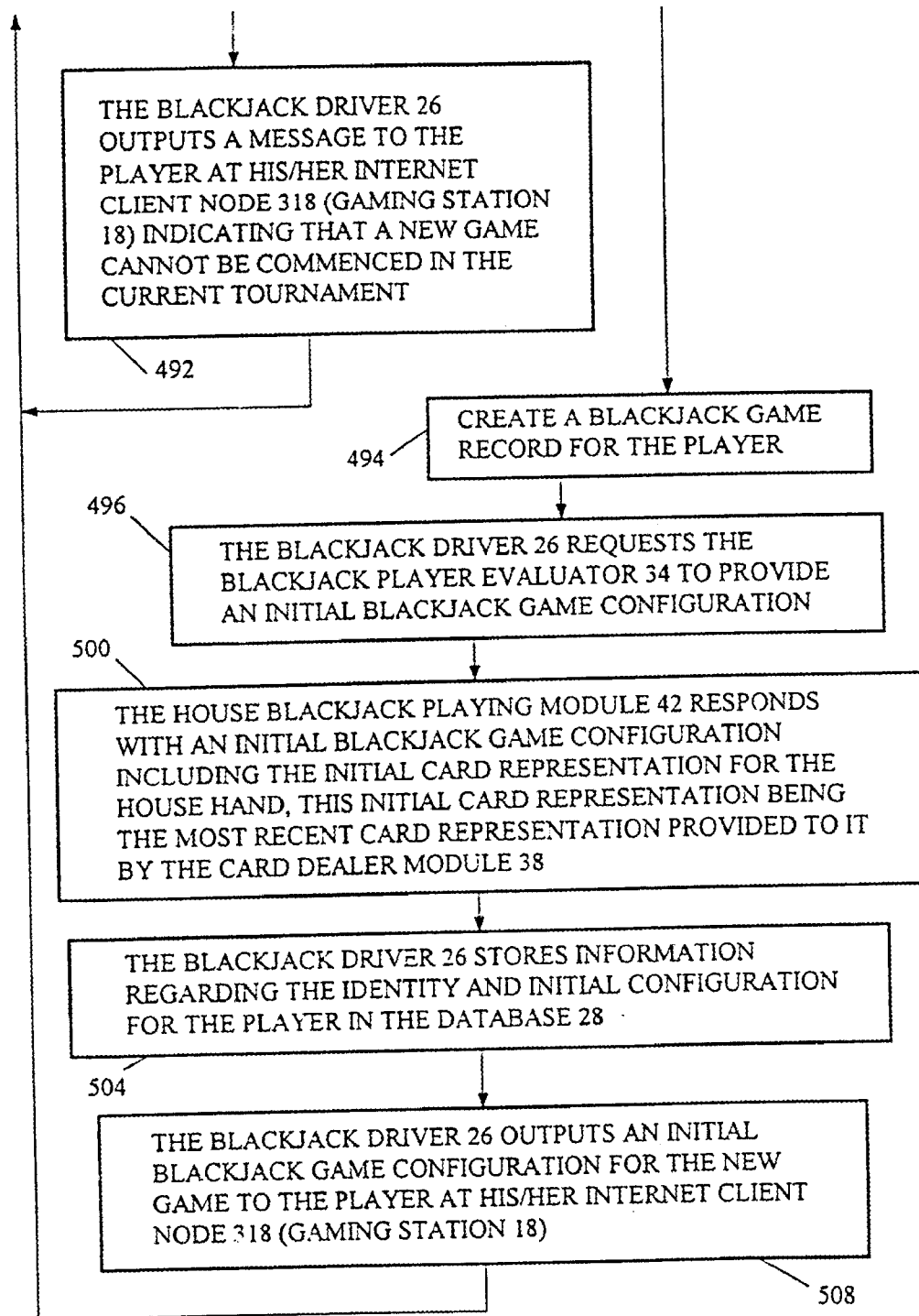

FIG. 4E

VALUES OF CARDS FROM CARD SEQUENCE OUTPUT BY THE CARD DEALER MODULE 38 →		604									
		3	5	7	2	9	8	10	10		
BLACK JACK GAME 610	PLAYER HAND EVALUATION	3		10	-		19				
	HOUSE HAND EVALUATION		5					13	23		
BLACK JACK GAME 614	PLAYER HAND EVALUATION		5				-	13		-	23
	HOUSE HAND EVALUATION				2						
BLACK JACK GAME 620	PLAYER HAND EVALUATION					7		16			
	HOUSE HAND EVALUATION				2				10	20	
BLACK JACK GAME 626	PLAYER HAND EVALUATION						9			19	
	HOUSE HAND EVALUATION								8		18

606

FIG. 5

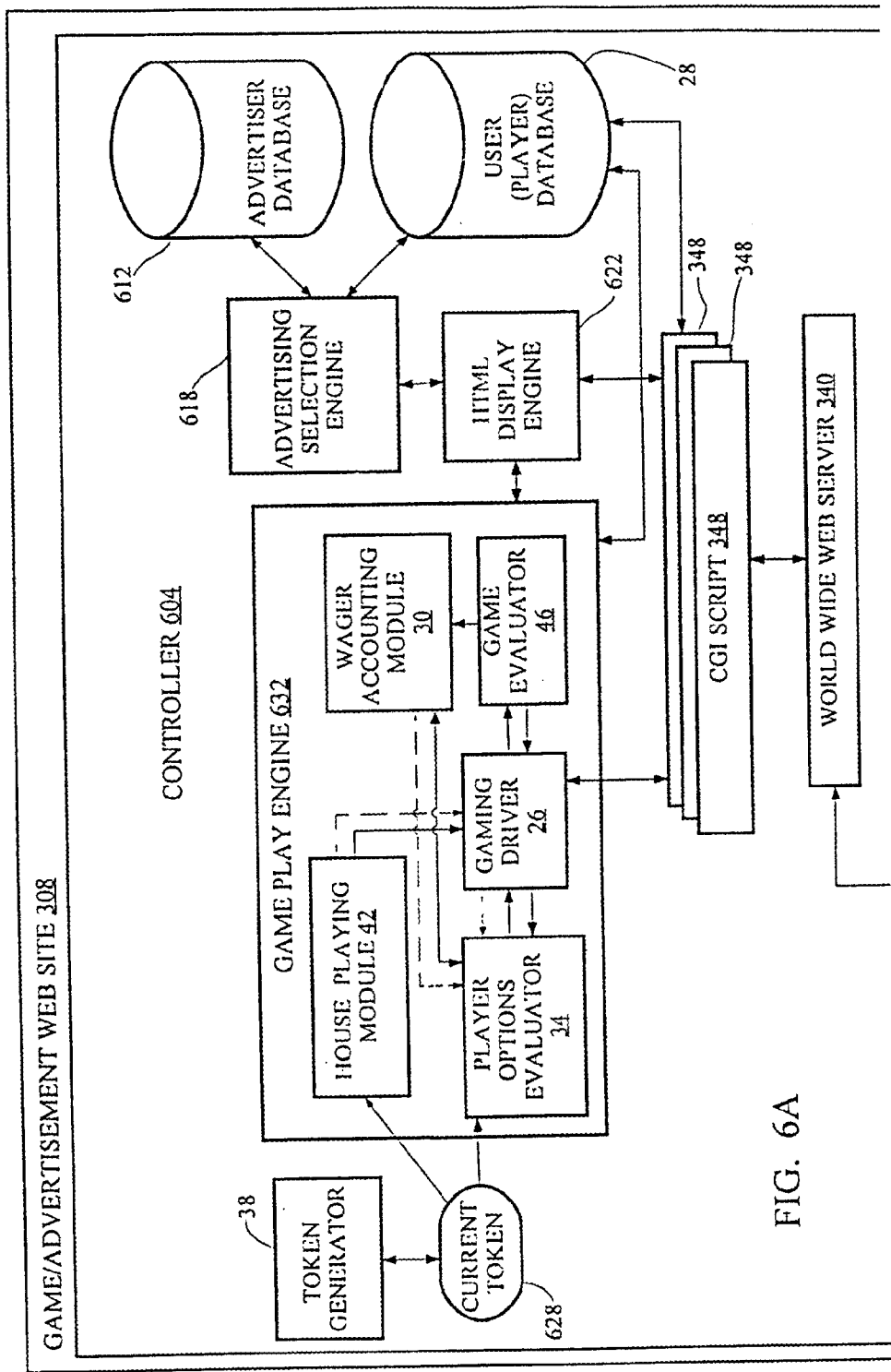

FIG. 6A

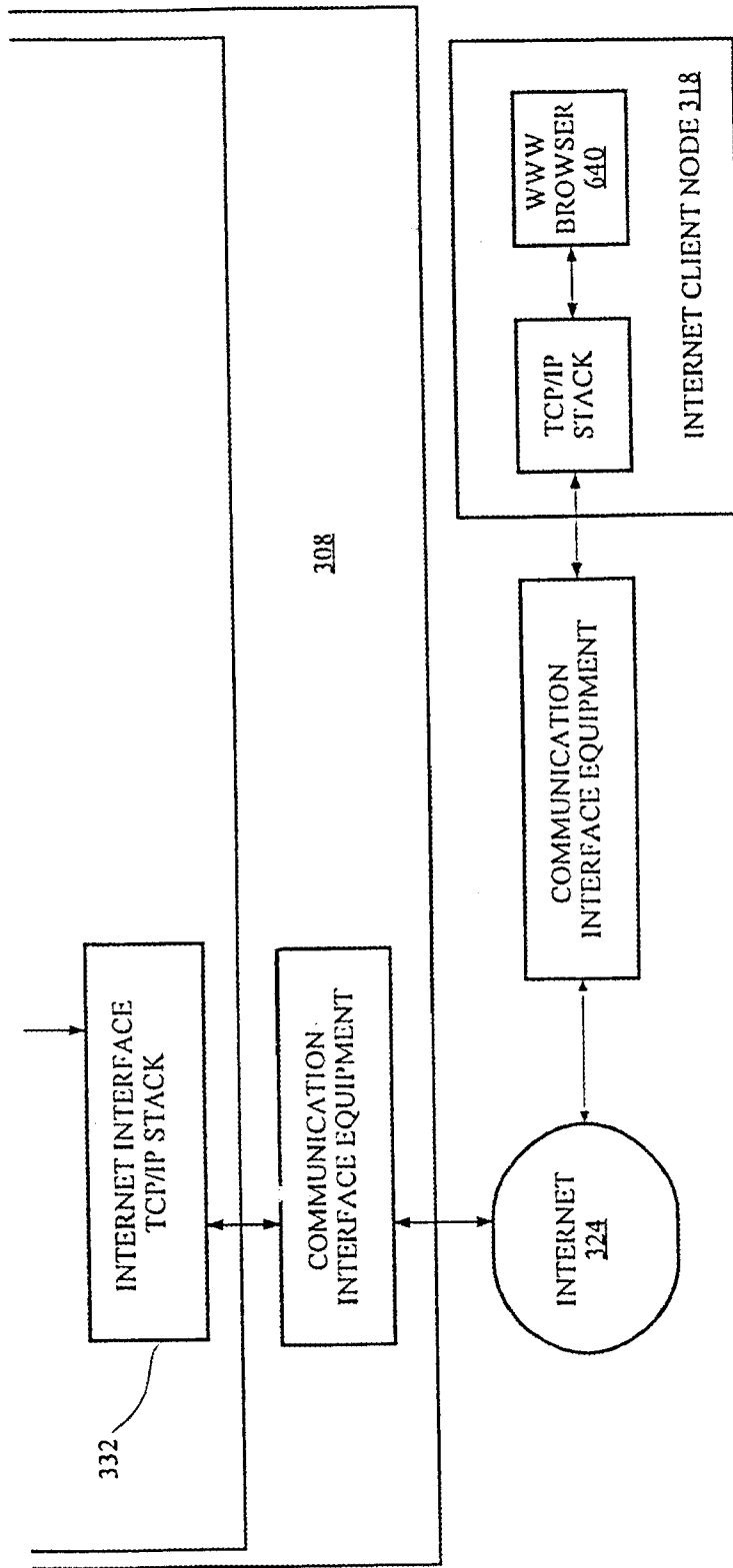

FIG. 6B

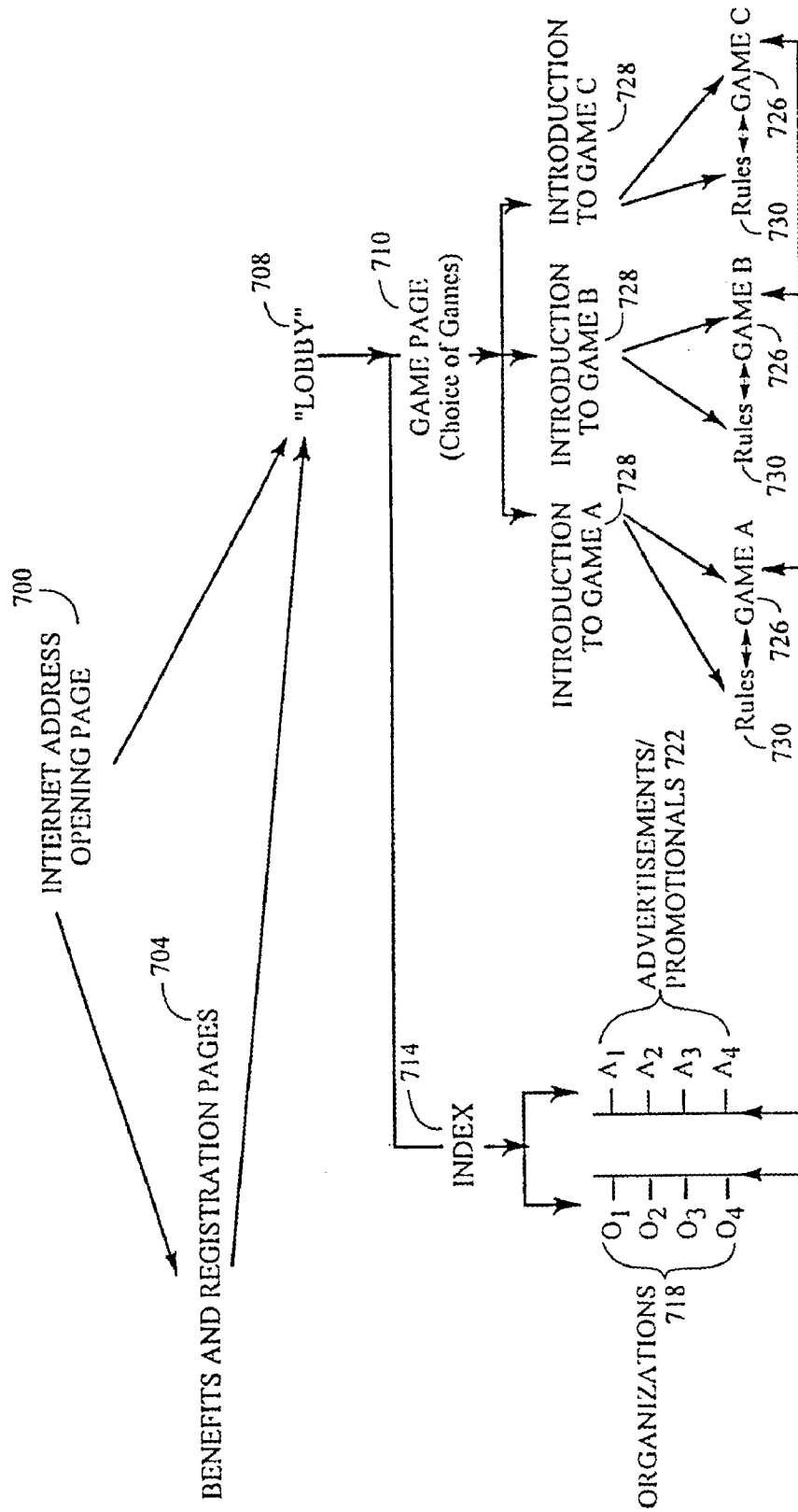

FIG. 7

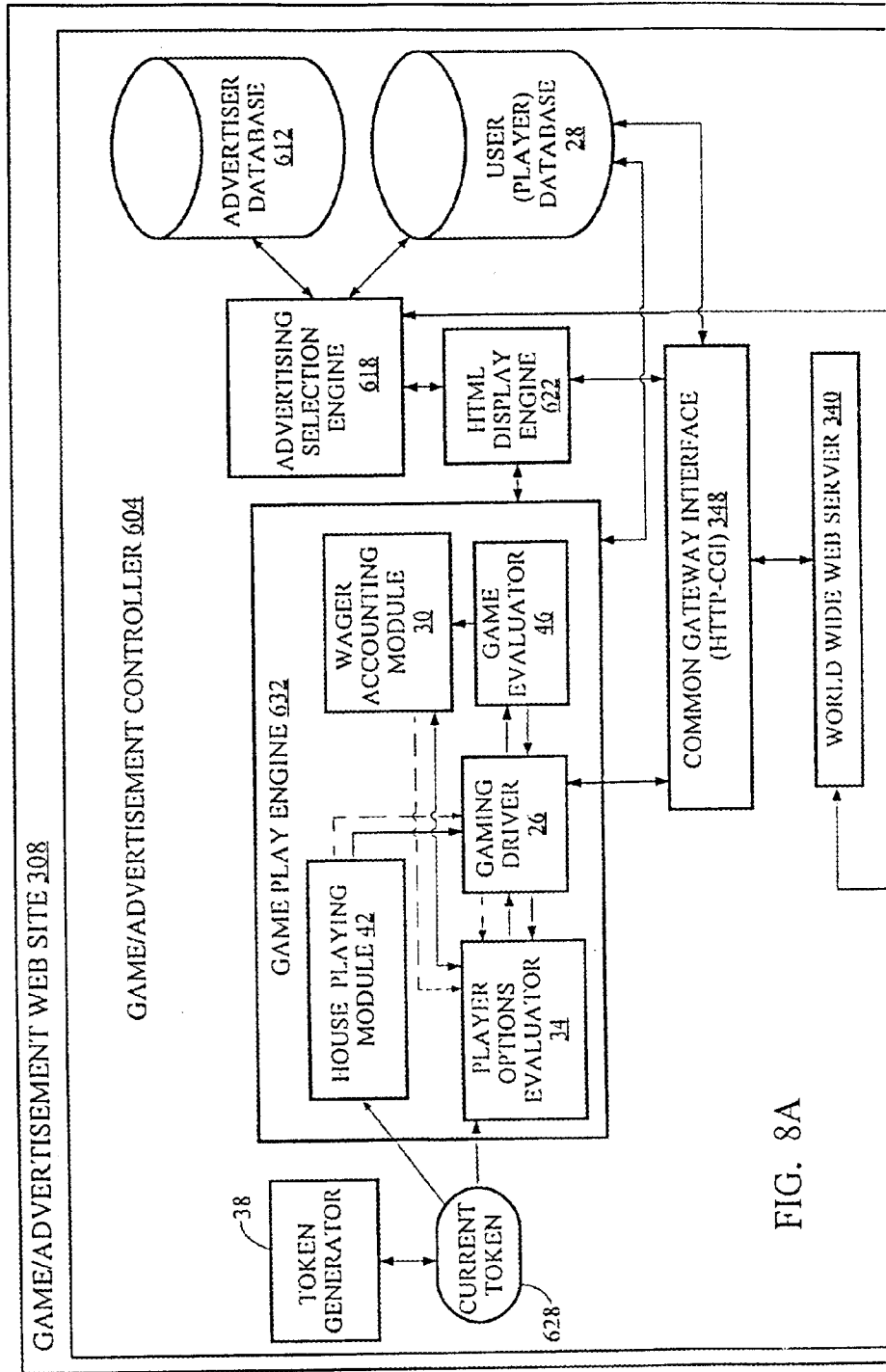

FIG. 8A



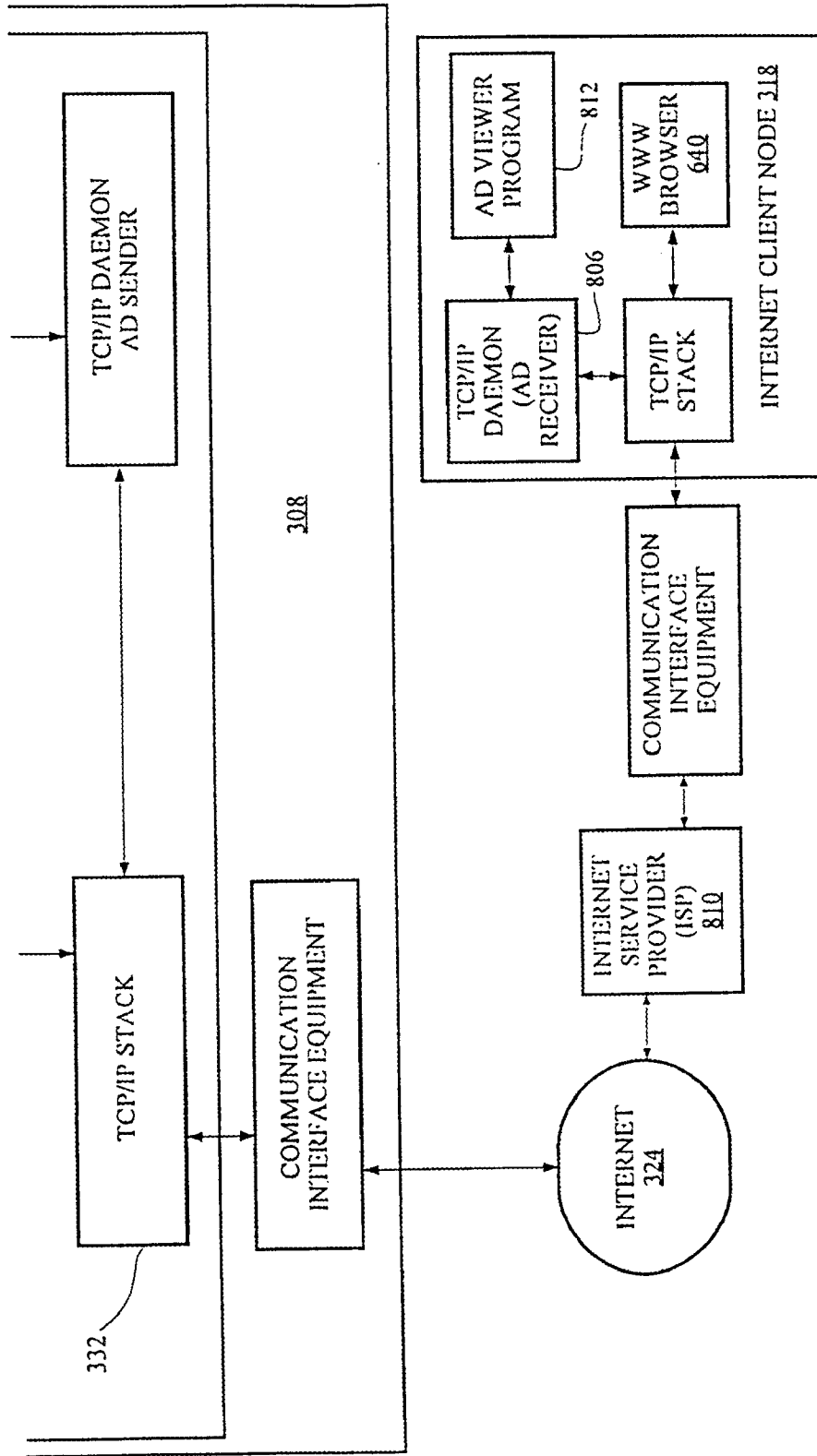

FIG. 8B

US 6,712,702 B2

1

## METHOD AND SYSTEM FOR PLAYING GAMES ON A NETWORK

### RELATED APPLICATIONS

The present patent application is a continuation of prior U.S. patent application Ser. No. 09/140,979 filed Aug. 27, 1998 (now U.S. Pat. No. 6,264,560), which: (a) claims the benefit of U.S. Provisional Patent Application No. 60/058,006 filed Aug. 28, 1997, and (b) is a continuation-in-part of U.S. patent application Ser. No. 09/105,401 filed Jun. 26, 1998 (now U.S. Pat. No. 6,183,366), which is a continuation of U.S. patent application Ser. No. 08/759,895 filed Dec. 3, 1996 (now U.S. Pat. No. 5,823,879) which claims the benefit of both U.S. Provisional Patent Application No. 60/010,361 filed Jan. 19, 1996 and U.S. Provisional Patent Application No. 60/010,703 filed Jan. 26, 1996. The entire disclosure of the prior applications are considered to be part of the disclosure of the present application and are incorporated herein by reference.

### FIELD OF THE INVENTION

The present invention is related to a method and apparatus for automating the playing games such as blackjack in, e.g., a game tournament context so that they can be played continuously and asynchronously by a potentially large plurality of players substantially, and wherein information related to goods and services for sale can be exchanged between players and sponsors of advertisements presented during the playing of a game.

### BACKGROUND OF THE INVENTION

The cost effective automation of playing certain games, like blackjack, has been difficult due to the fact that these games typically require a dealer and only a relatively small number of players may play the game with a single dealer. However, with the popularity of local and wide-area data communication networks, it is desirable to have an automated gaming system for games such as blackjack wherein large numbers of players may cost-effectively and efficiently play such games.

Furthermore, it has been difficult to cost-effectively provide a network gaming system on such networks as the Internet in that gaming restrictions prohibit wagering and ante fees in most contexts except such situations as local area networks within a casino. However, since many players have an interest in playing casino-type games, it would also be desirable to have a way to benefit from interests in such games. Accordingly, it would be desirable to have a system that utilized a gaming context as a vehicle for delivering product and/or service information to users of a network such as the Internet. In particular, it would be desirable to have a data processing system that provided a large number of players with the ability to substantially asynchronously play casino-style games on the Internet for prizes at a reduced risk or at substantially no risk, wherein the data processing system coordinated the presentation of products and/or services from sponsors of the games so that there is a coordinated, interactive exchange of information between players and sponsors regarding advertisements, samples, prizes and questionnaires related to sponsor-products and/or services.

Accordingly, since the present invention, as described in the sections hereinbelow, addresses the above-discussed problems within the context of playing blackjack, an overview of this particular game is provided so that the novelty

2

and various related aspects of the present invention may be more fully appreciated.

### Description of Blackjack

The card game of blackjack is a game of chance played between a designated player known as a "dealer" and one or more other players. Basically, each player plays against the dealer in the sense that each player attempts to achieve a collection or hand of cards having a total score for the hand closer to the value 21 than the score of the hand of the dealer. However, if a player's card hand goes over 21, the player may lose any wagers bet on the hand regardless of the value of the card hand of the dealer.

In further detail, blackjack is typically played with one or more standard playing card decks wherein each card has a value. In particular, each of the face cards has the value of 10, and non-face card has a value identical to the numerical value as indicated on the card, except for aces. That is, for aces a value may be assigned of either 1 or 11, depending on which value a player deems most beneficial to his/her hand.

In one conventional method for playing blackjack, at the commencement of a blackjack hand, each player initially is provided with two cards and the dealer also receives two cards. Typically, one of the dealer's cards is dealt with the value of the card showing whereas the other card is dealt with the value of the card hidden. However, variations on when the dealer receives his/her cards may depend on the blackjack gaming rules where blackjack is being played but, in any case, one of the dealer's cards must be face-up before the players exercise various wagering options beyond an initial ante.

After a player has reviewed his/her cards, the player may request one or more additional cards in an attempt to get: (a) a value for a card hand that will be greater than the hand the dealer will have, and (b) a value for the card hand that is less than or equal to 21. Further, a player may under certain circumstances, as will be described below, simultaneously play more than one hand of cards against the dealer's cards. However, in requesting such additional cards, a player runs the risk of "busting" each hand played wherein the player loses his/her wager(s) on a card hand by adding cards to the hand until a value exceeding 21 occurs. Further note that such busting of a hand occurs regardless of whether or not the dealer has a card hand value of less than or equal to 21.

Note that after each player has ceased to request further cards (i.e., each player "stands" on his cards), the dealer either takes one or more further cards (i.e., "hits") according to predetermined blackjack rules as established, for example, by the gaming establishment where the blackjack game is being conducted. In general, the dealer must take additional cards if his/her current card count total is less than 17 and the dealer must decline further cards if the dealer's hand has a value of 17 or more. However, there are various rules regarding whether a dealer may stand or hit when the card count total is a "soft 17." That is, one of the dealer's cards is an ace (and therefore may have a value of 1 or 11) and one of the values for the dealer's hand is 17. For example, the dealer may be required to take a hit on a soft 17.

Since a hit(s) taken by the dealer is performed after all players have exercised their wagering options, the final numerical value of the dealer's hand is then compared to the final numerical value of each of the player's hand(s) to determine the winning and losing wagers. Note that if the dealer's hand exceeds the value of 21, then any player that has not busted wins the wagers for their hand(s) regardless of the hand's total value. Alternatively, if the dealer's card hand is less or equal to 21, then it is compared with each of

US 6,712,702 B2

3

the player's card hand(s) and in each comparison the card hand with the closest total value to 21 without exceeding 21 wins. Of course, ties are possible. In such cases (called a "push"), the player's wager(s) on his/her card hand are returned.

It is typical in blackjack to have at least three additional player options depending on the circumstances of play. A first such option is known as "doubling down" wherein if the player's first two cards have a value within a predetermined range (e.g., 10 or 11), then the player may double his or her wager and once dealt a single additional card, the total of the three card hand becomes the value for the player's hand. Alternatively, another option is that of "splitting pairs" wherein if the player's first two cards are identical with the exception of suit (i.e., a pair), then the pair may be split so that two card hands are created with one card of the pair in each hand. Thus, the player must wager on each of the hands at least the initial wagering or ante amount. Subsequently, a second card and any subsequent successive cards are dealt to each of the separate hands as the player requests and the results of both hands are compared to the dealer's hand, assuming neither the dealer nor either of the player's two hands busts.

In a third option, played immediately after each player has been dealt their first two cards and the dealer has been dealt at least a first card, a player may request "insurance" under the circumstances where the dealer's single face-up card is an ace. In this circumstance, the player is betting that the dealer has blackjack (i.e., a card value total of 21). If the dealer does not have blackjack, then the insurance bet is forfeited and the player plays his/her blackjack hand as if the insurance bet were never made. Note that the player can typically wager an insurance bet of one-half of the amount of his/her initial blackjack wager or ante and if the dealer has blackjack, then the dealer (or the gaming establishment) pays the player double or triple his/her insurance bet.

Further note that options for splitting pairs and doubling down may interact with one another according to certain pre-established gaming establishment rules wherein, for example, a player may double down on one or more of his/her split hands.

Additionally, there are blackjack tournaments having tournament entrants that compete against each other for tournament prizes. In such tournaments each entrant has a fixed initial number of points that can be wagered in a pre-established number of tournament blackjack games to be played. Accordingly, the player having the highest number of points at the end of the tournament wins the tournament. Note that in such tournaments, there may be specific guidelines established at the beginning of the tournament for varying the blackjack gaming rules between tournament games. For example, rules may vary on when a player may split pairs repeatedly during the same blackjack game. Also, double down rules may vary so that, for example, after a splitting of pairs, a player may be allowed to double down on any two cards or, alternatively, an additional wager of less than the initial wager may be acceptable when a player requests to double down.

However, in all known variations of blackjack, players are only allowed to enter a blackjack game at the completion of a previous game and, further, there is a relatively small number of players that can play blackjack at a dealer's station simultaneously. Accordingly, it is desirable to provide a system for playing blackjack wherein potentially a very larger number of players can play blackjack simultaneously from a single dealer station and wherein players can commence playing blackjack at their own discretion without waiting for a previous blackjack game to complete.

4

## SUMMARY OF THE INVENTION

The present invention is a computerized interactive advertising system (i.e., method and apparatus) for exchanging information regarding goods and/or services between a first population of users (hereinafter also known as "players" or "users") and a second population of users (hereinafter also known as "sponsors" or "advertisers"). In particular, the sponsors or advertisers may present information related to goods and/or services to the players using the present invention and the players may view this information while, for example, interacting with the present invention for playing a game such as blackjack, craps, roulette, poker, pai gow or the like. Moreover, a player may also interact with the present invention so that the player has the capability for responding to sponsor or advertiser presented questionnaires, as well as for purchasing or viewing sponsor goods and/or services. Thus, the present invention provides an information exchange service within a gaming context for enticing players to view and/or interact with sponsor presentations such as interactive advertisements.

It is also an aspect of the present invention that each player or user is presented with advertisements for products and/or services, wherein it is believed the player will be receptive to the advertisement. That is, the present invention selectively presents advertisements to each player, according to stored characteristics and preferences of the player that the present invention has determined from, for example, player supplied personal information, player responses to questions, and/or analysis of player interactions such as player requests for additional information related an advertisement. Thus, such a selective presentation of advertisements allows a sponsor or advertiser to provide information related to relatively extensive or expensive promotionals (e.g., demonstrations, samples, discounts, trial subscriptions, prizes, bonuses) to players most likely to subsequently purchase the advertised product or service. Consequently, such selectivity can greatly increase the cost effectiveness of advertising, wherein the term, advertising (or advertising presentation), as used herein is understood to include not only product or service presentations that are merely informational, but also more interactive advertising presentations such as promotionals wherein discounts, free samples or a trial usage may be offered.

Moreover, it is an aspect of the present invention that each player may interact with and play a game at a time and pace (i.e., tempo) substantially of the player's choosing. In particular, the player is not bound by a required order or sequence of play involving other players, even though the player may be in competition with other players. In fact, a player may cease play for an extended time while in the midst of a game and subsequently continue the game at the point where the player ceased to play. Thus, if the present invention is easily accessible, then players may interact with the present invention at their leisure.

Accordingly, in a related aspect of the present invention, it is intended that players (more generally, users) are able to interact with the present invention remotely, as for example, via the Internet and/or an interactive cable television network. Thus, using an Internet embodiment as an exemplary embodiment of the present invention, a gaming web site may be provided wherein players may access the interactive gaming capabilities of the present invention and substantially simultaneously also be presented with sponsor or advertiser provided information related to goods and/or services of the sponsor or advertiser (those two terms being used substantially interchangeably to denote e.g., those who

US 6,712,702 B2

5

provide advertising to users and/or subsidize game playing, product promotions or network access). Moreover, the sponsor provided information may include, for example, hypertext links (also denoted hyperlinks) that allow players to activate, for example, network transfers for obtaining additional information regarding a sponsor's goods and/or services regardless of the status of any game in which a player may be currently involved at the gaming web site.

It is a further aspect in one embodiment of the present invention that a player is able to commence play of a game at substantially any time the player accesses the present invention. That is, it is not necessary for any previous game being played by other players to be completed for the player to commence play. In other words, games provided by the present invention may be continuously and asynchronously commenced or entered by players.

It is a further aspect of the present invention to require each player to use a distinct identification provided when the player "registers" with the present invention before playing any games so that a network site for the invention may be able to identify each player. Accordingly, it is an aspect of the present invention during registration, that each player provides personal information about him/herself both for gaming identification and for use as selection criteria by sponsors or advertisers for presenting particular presentations. For example, in the case of an Internet embodiment of the present invention, such registering can be performed via the Internet prior to play of any games at a gaming/advertising web site. Thus, players may be required to provide the present invention with information about themselves such as name, address, E-mail address, age, sex, and/or other player characteristics deemed pertinent to one or more sponsors or advertisers. Accordingly, the present invention provides a sponsor or advertiser with the capability to target its presentations substantially only to players or users having selected characteristics as, for example, determined from player information provided when registering with a network site for the present invention.

It is a further aspect of the present invention to have players compete against one another for prizes in one or more gaming tournaments. Using the Internet embodiment of the present invention as illustrative, a gaming/advertising web site for the present invention may partition the population of players into competitive groups wherein each group includes the players for a distinct tournament. Moreover, the present invention may determine a competitive group according to criteria such as: (a) the game(s) to be played in the tournament; (b) a skill level for the players (e.g., as determined by play in a previous tournament(s)); (c) particular player characteristics such as age, area of residence, home ownership, etc.; (d) particular player lifestyle traits such as traits exhibited by exercise enthusiasts or cruise ship enthusiasts; and (e) particular player preferences such as preferences related to jewelry, personal care products or particular sports.

It is a further aspect of the present invention to allow players to play games offered by the present invention without incurring financial risk or charges beyond those that are typical for the network being used in accessing the present invention.

It is a particular aspect of the present invention to provide blackjack and other casino-style games such as craps, roulette, poker, pai gow, or variations thereof, wherein such games may be played by a plurality of players continuously and asynchronously, and wherein each game is likely to be unique from all other games being played concurrently.

6

Furthermore, in a related aspect of the present invention, such games may be automated so as to not require a manual dealer. Also, the present invention may be played, in one embodiment, in a gaming establishment (e.g., casino) using low cost gaming stations at which players may play such games entirely electronically. Alternatively, in another embodiment, the present invention may be used to play such casino style games as blackjack on the Internet. In this later embodiment, a blackjack game controller for the present invention communicates with blackjack players at Internet client nodes via a web site from which the blackjack game controller is accessed. Thus, blackjack players may play blackjack in the privacy of their own homes and at their leisure since the present invention does not require that a particular tempo of a blackjack game be maintained.

Additionally, the present invention utilizes novel varieties in such games, as blackjack, that make the games more enjoyable for users. For example, using variations of blackjack as illustrative, in one novel embodiment wherein the dealer functions are automated by a dealer module, this module can play blackjack with a plurality of players concurrently such that each player appears to be playing exclusively with the dealer module (e.g., "head-to-head"). Moreover, in one blackjack embodiment, each blackjack game is played asynchronously from other concurrent blackjack games with the dealer module. Furthermore, the dealer module may play a different dealer card hand with each player. In particular, the initial one (or two) cards (or card representations) dealt to the dealer for each game are unlikely to be the same for any two blackjack games being played with the dealer module; i.e., the probability of any two concurrently played blackjack games being identical is substantially equal to chance. Accordingly, this variation is particularly worthwhile when players are playing remotely through a network such as the Internet. Alternatively, in a different blackjack variation, the dealer module and each player concurrently playing blackjack with the dealer module may be provided with cards (or card representations) from the beginning of an identical sequence of card representations. Thus, each concurrently playing player receives an identical initial card hand and the dealer is also dealt an identical initial card hand. Subsequently, the card hands within each concurrent game will vary only if players request further cards differently. Accordingly, this variation of blackjack is particularly useful in tournament blackjack played within the confines of a casino, wherein the play of each player in the tournament is synchronized to start and stop within a predetermined interval. Note that this variation of blackjack is enjoyed by tournament players in that the tournament players may consider it a better or fairer way for demonstrating blackjack playing skill.

Other features and benefits of the present invention will become apparent from the detailed description with the accompanying figures contained hereinafter.

#### BRIEF DESCRIPTION OF THE DRAWINGS

FIG. 1 is a block diagram of an embodiment of the present invention wherein this embodiment may be used within a blackjack gaming establishment such as a casino;

FIG. 2 provides a representation of the gaming stations 18 of FIG. 1 wherein these gaming stations are used in gaming establishments for playing blackjack;

FIG. 3 is a block diagram of an alternative embodiment of the present invention wherein the present invention is used to play blackjack on the Internet;

FIGS. 4A-4E represent a flowchart for the processing performed by the blackjack game controller 14 when pro-

US 6,712,702 B2

7

cessing blackjack requests from players in either of the embodiments of FIG. 1 or FIG. 3;

FIG. 5 provides a simple example of the operation of the present invention for playing a novel variation of blackjack wherein four blackjack games are shown being played asynchronously with the blackjack game controller;

FIGS. 6A and 6B are a block diagram of an Internet embodiment of the present invention;

FIG. 7 is a diagram illustrating how a user navigates through web pages of the World Wide Web for accessing the game/advertisement web site 308 (FIG. 6) functionality; and

FIGS. 8A and 8B are an alternative embodiment of the game/advertisement web site 308. In particular, FIGS. 8A and 8B is a block diagram of an alternative embodiment of the present invention wherein an advertisement sending daemon (i.e., TCP/IP daemon ad sender on the host computer 308) and an advertisement receiving daemon 806 (on the client end user machine 318) communicate for periodically displaying advertisements and other announcements to a user on the end user machine 318.

#### DETAILED DESCRIPTION

In FIG. 1, a block diagram is presented of a first embodiment of an electronic system 10 for the present invention for playing blackjack, wherein data flows are represented by solid arrows and control flows are represented by dashed arrows. In particular, the embodiment of FIG. 1 presents an architecture for the present invention for use on, for example, a local network within a casino, wherein low cost gaming stations may be utilized. Accordingly, the blackjack gaming system 10 includes a blackjack game controller 14 electronically connected to one or more potentially remote gaming stations 18 so that for each gaming station a player may play blackjack. In the blackjack gaming system 10, the blackjack game controller 14 functions substantially as a dealer would in a manually operated blackjack game and each gaming station 18 provides a blackjack player with an electronic representation of a blackjack game wherein it may appear that the player (i.e., user) at the gaming station 18 is the only player playing against the dealer (i.e., "head-to-head" against the blackjack game controller 14). Accordingly, each gaming station 18, as will be discussed with reference to FIG. 2 below, includes a display for displaying both the dealer's cards and the player's cards. Each gaming station 18 also includes player interaction capabilities for requesting additional cards, activating various blackjack player options at appropriate times, and potentially increasing various wagers at predetermined phases of a blackjack game. Further note that each gaming station 18, when in operation, may request a security code be provided by a player for identifying himself/herself or, alternatively, the gaming station may request the player to insert an electronic card (not shown) into the gaming station 18 so that information electronically encoded upon the card is read at the gaming station and transferred to the blackjack controller 14.

Referring now to the internal structure of the blackjack game controller 14, a gaming station interface 22 is provided for interfacing with each of the gaming stations 18. In particular, the gaming station interface 22 buffers data signals between the other components included within the blackjack game controller 14 and the gaming stations 18. For example, the gaming station interface 22 may have speed matching buffers in order to adjust for differences in speed between the blackjack game controller 14 and the gaming stations 18. A blackjack driver 26 exchanges data

8

with the gaming station interface 22. The blackjack driver 26 substantially coordinates the operation of the blackjack game controller 14. In particular, the following capabilities are substantially provided by the blackjack driver 26:

- (1.1) identifies each player requesting to play blackjack at one of the gaming stations 18;
  - (1.2) creates internal data structures for communication with other modules of the blackjack game controller 14 regarding each blackjack game being played; in particular, blackjack gaming data objects or records are (re)instantiated with each player request, such data objects providing sufficient information for the blackjack game controller 14 to properly respond to each received player request;
  - (1.3) determines the output of the blackjack game controller 14 to each of the active gaming stations 18;
  - (1.4) distributes blackjack gaming data between other modules of the blackjack game controller 14; and
  - (1.5) provides card representations to gaming stations 18.
- In performing the above tasks, the blackjack driver 26 communicates with a blackjack player registration and playing status database 28. The database system 28 maintains in persistent storage information regarding each blackjack player. In particular, the database system 28 maintains:
- (2.1) information identifying each player; e.g., a unique player identification code;
  - (2.2) information regarding, for example, each blackjack player's financial status; in particular, a credit limit and a current amount of funds (either to be paid or received from the player);
  - (2.3) for each person registered to play blackjack, information regarding the status or context of any game the player is presently playing; that is, sufficient information is stored so that the blackjack game controller 14 can retrieve this information and continue a blackjack game in response to receiving a player's request;
  - (2.4) for each person registered to play blackjack, information regarding any blackjack tournament that the player is playing; in particular, since such a tournament typically requires a tournament player to complete a specified number of blackjack games in a predetermined amount of time and/or to complete a specified number of blackjack games out of a total number of blackjack games, the following types of information maybe stored: (a) information relating to the number of blackjack games completed by the player; (b) information related to the time and/or the number of games remaining in the tournament; and (c) information related to the amount of funds or points in the player's account for the tournament.

The blackjack driver 26 communicates with a wager accounting module 30 wherein the wager accounting module provides the following capabilities:

- (3.1) determines various wagering limit parameters for the next one or more blackjack games to be played (e.g., the wagering limit per game and the total wagering limit per player); and
- (3.2) performs wagering accounting for each player's wins and losses.

Thus, the wager accounting module 30 is instrumental in initializing a new blackjack game in that this module receives and maintains financial information related to each currently active player at a gaming station 18. Thus, the wager accounting module 30 has a communication data channel with the blackjack player registration and playing

US 6,712,702 B2

9

status database **28** so that the wager accounting module **30** may retrieve information for determining whether the player has, for example, sufficient financial resources to cover potential wagering losses. Of course, to provide wagering evaluation information to other controller **14** modules, the wager accounting module **30** receives identifying information from each such module requesting an evaluation.

The blackjack driver **26** also communicates with a blackjack player evaluator **34**. The blackjack player evaluator **34** receives, from each player (via instantiations of blackjack gaming data objects from the blackjack driver **26**), all blackjack player requests except the data from each player indicating an amount to be wagered. Thus, the blackjack player evaluator **34**:

- (4.1) determines each player's options during blackjack games; and
- (4.2) responds to player requests for hits or to, for example, split pairs.

Thus, the blackjack player evaluator **34** enforces the gaming establishment rules related to player options during a blackjack game. Note, however, that in responding to certain player requests, the blackjack player evaluator **34** communicates with the wager accounting module **30** to confirm that a proper wager accompanies the requested option and that the wager is acceptable to the wager accounting module **30**.

The blackjack player evaluator **34** is supplied with data corresponding to blackjack card representations from a card generator module **38**. The card generator module **38** generates, for example, an ordered collection or sequence of substantially random card representations and each such card representation is provided to the blackjack player evaluator **34**, wherein the blackjack player evaluator responds to each player's valid hit request by outputting the most recent card representation received from the card generator module **38**. That is, each player at a gaming station **18** receives a card representation according to when the player's request is received by the blackjack player evaluator **34**.

Further, note that the card generator module **38** also supplies the same card representations as supplied to the blackjack player evaluator **34** to a house blackjack playing module **42**, wherein this latter module plays the dealer's hand in each blackjack game. Thus, the house blackjack playing module **42** enforces the blackjack gaming rules on behalf of the gaming establishment. In particular, this module determines when and how insurance bets can be made related to the dealer's cards. Note, as with the blackjack player evaluator **34**, the house blackjack playing module **42** outputs, when required to provide the dealer's hand with another card representation at a gaming station **18**, the most recent card representation received from the card generator module **38**. Further note that the house blackjack playing module **42** provides control information to the blackjack driver **26**, particularly regarding activation of the blackjack insurance option. This information, in turn, is conveyed to the blackjack player evaluator **34** so that this latter evaluator may activate the insurance option for each player at an active gaming station **18**.

A blackjack hand evaluator **46** is also in communication with the blackjack driver **26**. The blackjack hand evaluator **46** evaluates each player's hand(s) in comparison to the dealer's blackjack hand for determining the win/loss/tie for each player's hand. Thus, the dealer's hand and the one or more hands played by each player at a gaming station **18** is supplied to the blackjack hand evaluator **46**. Subsequently, this evaluator outputs win/loss/tie results to the gaming stations **18** via the blackjack driver **26** and the gaming

10

station interface **22**. Further, the blackjack hand evaluator **46** also outputs win/loss/tie results along with the identity of the player playing each hand to the, wager accounting module **30** so that wager credits and debits for each player's account may be updated according to the last or most recent blackjack game results.

In FIG. 2, an embodiment of a gaming station **18** is illustrated. The gaming station **18** includes a player input area **204** wherein a player may press touch-sensitive portions of a thin film laminated with blackjack player operations and requests. Immediately above the player input area is a player output display area **208** for displaying blackjack gaming information related to the player. Optionally, each gaming station **18** may include a player identification card reader **216** so that a blackjack player may identify him/herself at a gaming station **18** by swiping a magnetic identification portion of a player identification card (not shown) through the card slot **220** thereby allowing the card reader **216** to transmit the player's encoded identification upon his/her card to the blackjack game controller **14**. However, it should be noted that other configurations of the gaming station **18** are also contemplated by the present invention. In particular, gaming station **18** may not have a card reader **216**. Instead, a blackjack player may be required to register either manually or automatically at a site remote from the gaming station **18**, or, alternatively personal identification numbers may be provided to players for identifying themselves via the player input area **204** wherein, for example, a numeric digit provided in the lower bottom portion of some of the touch-sensitive areas may be used by the player to input a personal identification number. Further, the arrangement of the touch-sensitive portions of the player input area **204** and the format of the display area **208** (both being discussed in detail below) may have other arrangements and still be within the scope of the present invention.

Describing in detail now the touch-sensitive portions of the player input area **204**, an activate/enter next game button **220** is provided. This button is used to initially activate the gaming station **18** so that a "request to play" signal is transmitted to the blackjack driver **26**. That is, assuming a player activates this button at a gaming station **18**, the blackjack driver **26** responds by requesting that the player input his/her identification via, for example, placing an identification card in the card reader **216** and/or a personal identification number via the player input area **204**. Additionally, note that the button **220** may be pressed at the end of a blackjack game for indicating that the player wishes to play another blackjack game. Note that in one embodiment of the present invention when consecutive games are played by a player, the player need only press the button **220** to commence a new game. That is, the player's identification need not be entered for each consecutive game played (assuming the button **220** is activated within a predetermined time after the last game has terminated).

The player input area **204** also includes a quit button **224** that a player may press to explicitly indicate the player's desire to terminate any further gaming at the gaming station **18**.

Additionally, buttons **228** through **248** provide the player with the capabilities to request the following blackjack gaming requests:

- (5.1) The "HIT" button **228** allows the player to request another card to be dealt to him/her.
- (5.2) The "STND" button **232** allows the player to stand on a current blackjack hand.
- (5.3) The "DBL" button **236** allows the player to double down under appropriate circumstances as determined by the blackjack player evaluator **34**.

US 6,712,702 B2

11

(5.4) The "SPLIT" button **240** allows the player to split the player's first two cards into two separate blackjack hands when these first two cards are identical.

(5.5) The "INS" button **244** allows the player to request insurance under the circumstances where the dealer's single face-up card is an ace.

(5.6) The "BET" button **248** allows the player to request that a bet or wager be entered during a blackjack game.

Note that subsequent to requesting a bet via the "BET" button **248**, the buttons **252** through **264** are activated so that the player may input various betting amounts. In particular, buttons **252** through **264** provide the player with the option to bet \$5.00 (button **252**), \$25.00 (button **256**), \$100.00 (button **260**) and \$500.00 (button **264**). Moreover, a sequence of the buttons **252** through **264** may be pressed for obtaining a bet not provided by a single button. For example, to bet \$130.00, the player presses consecutively each of the buttons **252**, **256** and **260** (in any order) exactly once.

The player input area **204** also includes various confirm and cancel buttons **268** through **276**. The accept button **268** allows the user to accept a last input. For example, it is an aspect in the present embodiment of the invention that after each user input, the input is accepted either by the player explicitly pressing the accept button **268** or by allowing a predetermined amount of time to expire after the last player input. The "CANCEL BET" button **272** allows the user to cancel an immediately preceding bet that was input. However, note that if a time limit is exceeded for placing a bet due to, for example, the player pressing the "CANCEL" button **272**, then any minimum bet required will be automatically wagered on the player's behalf by the wager accounting module **30**. Further, the "CANCEL LAST" button **276** may be used by the player to cancel the immediately preceding wager of one of the dollar amount buttons **252** through **264**. Thus, if a player intended to bet \$125.00 by pressing first the button **260** followed by the button **256** but instead pressed the button sequence **260** and **264**, then the player may press the button **276** for canceling the \$500.00 bet associated with button **264** and subsequently the player presses the button **256** to obtain the desired bet of \$125.00. Note further that pressing the "CANCEL LAST" button twice in succession also cancels the entire bet.

A "SPEED OF PLAY" button **280** may be optionally provided on the player input area **204**. This button allows the player to specify to the blackjack driver **26**, for example, the predetermined amount of time after a player input to wait before each subsequent input is automatically accepted. In one embodiment of the present invention, the "SPEED OF PLAY" button **280** includes active areas at each end of the button, wherein if the user presses the "slower" end of the button **280**, then the predetermined time(s) for automatically accepting a player input is lengthened. Alternatively, if the player presses the "faster" end of the button **280**, then the predetermined default acceptance time(s) becomes shorter. However, it is important to note that the tempo of the blackjack game is, using the present invention, no longer as important as in typical blackjack gaming situations. That is, since each blackjack player using the present invention is not playing in sequence with other players, there is less concern about speedily playing so as not to delay other players.

Lastly, the player input area **204** includes a "HELP" button **284** for allowing the player to request assistance from, for example, the personnel of the gaming establishment providing the gaming station **18**.

Referring now to display area **208**, the screen display provided here is but one of a number of contemplated screen

12

layouts for the present invention. In particular, the screen layout illustrated in display area **208** is a representative layout for use in playing tournament blackjack. Thus, when other modes of blackjack are played other than tournament blackjack, then it is within the scope of the present invention to modify the fields represented in the display area **208** according to the player needs for the type of blackjack being played. Further, it is important to note that in one embodiment, the display **208** is in color so that, for example, diamonds and hearts are in red and spades and clubs are in black, and various fields of the display area **208** may be highlighted for focusing a player's attention on the portion of the display providing information most relevant to the player's currently permissible options.

Describing now the fields currently presented in display **208**, at the top of the display is the house hand area **288**: (a) for providing a representation of the cards that have been dealt to the house; (b) for providing a status of the house hand (i.e. one of: "STND" for standing, "BUSTED", when the value of the house hand exceeds **21**, and "CONTINUING" when the house may take additional hits. That is, this field provides an annotation "house hand:" followed by a representation for at least one card that has been dealt to the house; i.e., an ace of hearts. In the player's hand area **292** of the display area **208**, there are five columns providing information related to each blackjack hand the player is currently playing in the blackjack game. The columns provide the following information:

(6.1) The "PLAYER HAND(S)" column provides, in each row of this column, a different blackjack hand that is being played simultaneously by the player in the current blackjack game. Thus, two blackjack hands are presently represented as being played simultaneously by the player on the display area **208**. That is, an upper or first hand having a three of spades, king of hearts, and a five of spades, and, a lower or second blackjack hand having a three of clubs and an eight of diamonds. (Note, when a player chooses to double down, card representations in common between two blackjack hands may be displayed in a row between the remaining card representations for both hands. Alternatively, card representations in common between blackjack hands may be duplicated in the blackjack hands to which the common cards representations apply.)

(6.2) A "STATUS" column for indicating the current status of each blackjack hand the player is playing. That is, for the first or upper hand that the player currently is playing the status is "STND" thereby indicating that the player has elected to stand on this hand. Alternatively, for the second or lower hand a status of "PICK OPTION" is provided thereby indicating that it is the player's turn to pick a blackjack playing option for this hand. Note that there are at least three possible values for the status field of each blackjack hand being played. That is, in addition to the two represented in FIG. 2, a "BUSTED" status value is output for indicating that the value of the related blackjack hand has exceeded **21**.

(6.3) The "OPTIONS" column provides, for each blackjack hand being played, an indication of the permissible blackjack plays that the player currently may select from for the related blackjack hand in the same row. Thus, for the first hand illustrated in area **292**, there are no options remaining for the player to play related to this hand. However, on the second hand, four permissible player inputs are displayed as options to the player. That is, the player may stand on the related hand

US 6,712,702 B2

13

(STND) by pressing button 232, the player may request a hit (HIT) by pressing button 228, the player may double down (DBL) by pressing button 236 and the player may bet an additional wager by pressing button 248 and subsequently putting a bet amount using buttons 252 through 264.

(6.4) The "LAST BET" column displays to the player his/her last bet for each blackjack hand the player is currently playing. In particular, for both the upper and lower hands shown in area 292, the player's last bet was \$50.00.

(6.5) The "TOTAL BET" column displays to the player the total bet the player has wagered on the blackjack hand to which it relates. For example, in FIG. 2, in both the upper and lower player's blackjack hands displayed, the player has bet a total of \$200.00.

Below the player hand area 292 is the player information area 296 wherein additional blackjack gaming information relating to the player is displayed. In particular, labeled line 300 displays the most recent bet amount that the player has requested along with a tag indicating the status (e.g., "ACCEPT/CANCEL") of the most recent bet. Note that the status may be: (a) "ACCEPTED" for explicitly or implicitly indicating the acceptance of a displayed wager (via the player pressing the accept button 268 or by default due to a time limit expiring); (b) "CANCELLED" for explicitly indicating the cancellation of the last entered wager (via the player pressing either of the cancel buttons 272 or 276); (c) "REJECTED", this status being displayed due to the wager accounting module 30 rejecting the player's most recent bet; and (d) "ACCEPT/CANCEL" for indicating that the present invention is waiting a predetermined amount of time for the player to explicitly accept or cancel the most recent bet. Thus, in the example of line 300 in FIG. 2., the player has indicated a most recent bet of \$30.00 and the blackjack driver 26 has output a status of "ACCEPT/CANCEL" as in (d) above. Further note that the blackjack hand(s) to which this most recent bet applies may be designated in any of a number of ways such as, for example, highlighting the row(s) in the player hand area 292 of the blackjack hand(s) to which the most recent bet of line 300 applies. Alternately, an indicator such as arrows 302 may be used as in FIG. 2 to indicate to the player that the most recent bet is to be applied to both the upper and lower blackjack hand(s).

Additionally, note that line 304 displays the annotation "INSURANCE BET:" together with any insurance amount that has been bet by the player. Accordingly, the dollar amount on line 304 and the notation at the right end of the line pertain, respectively, to the amount that has been bet as insurance, and the status of this bet (i.e., one of "ACCEPTED", "CANCELLED", "REJECTED" or "ACCEPT/CANCEL" as in line 300).

In line 312 of the player information area 296, the total amount of funds available by the player for betting is displayed. For example, line 312 of FIG. 2 indicates that the player has a total amount for betting of \$1,000.00. Note that the wager accounting module 30 maintains this total amount available for betting and updates it after each blackjack game.

The lower three lines 320, 324 and 328 of the player information area 296 provide blackjack player information that is particularly useful when playing in a blackjack tournament. Thus, the information in these three lines may not be displayed when the present invention is used by players not in a tournament. In line 320, two fields are provided for displaying playing time information. The leftmost field, annotated by the label "ELAPSED PLAYING

14

TIME:", displays the total amount of time the player has played blackjack (which in this case is 45 minutes). Alternatively, the rightmost field, annotated by the label "REMAINING PLAYING TIME:", displays the time remaining in the tournament.

In line 324 an identifier for any tournament associated with the present blackjack game is displayed.

In line 328, up to two additional fields are provided that are useful in tournament blackjack. The leftmost field having an annotation of "GAMES PLAYED:" displays to the player the number of blackjack games he/she has completed within a tournament. Note that in some blackjack tournaments each player is required to complete a certain predetermined number of games within a predetermined allotted time period. For example, a blackjack tournament may require each player to play 50 games within a predetermined interval (such as four days). Relatedly, but optionally, in blackjack gaming contexts where the total number of blackjack games in the tournament is meaningful, the rightmost field of line 328, having the annotation "GAME NUMBER:", displays to the player the total number of tournament games that have been completed thus far in the tournament. Accordingly, using at least the leftmost annotated field in line 328 and "REMAINING PLAYING TIME:" annotated field of line 320, the player is able to determine the number of remaining games in the tournament that he/she must play.

Further note that other blackjack game values are contemplated by the present invention. For example, a field providing the number of games remaining that a player must play in the tournament may be added (or substituted for) in addition to the current values in the player information area 296.

In a next display 208 lower area, denoted the rules area 336, blackjack house rules are displayed. In particular, the house rules displayed in area 336 allow variations upon the typical blackjack rules that a player is likely to assume if not presented with information to the contrary. Note that by providing these additional rules on the display of gaming stations 18, successive blackjack games may be provided with different house blackjack rules thereby creating an increased interest in each game by the players and requiring additional blackjack playing skills from the players. Note that three house rules are provided in the present display area 336. That is, (a) insurance for the present blackjack game pays 3 to 1 odds (instead of the typical 2 to 1 odds); (b) the player may double down after splitting only once; and (c) the minimum bet is \$25.00 for the current game.

Lastly, the display 208 includes a player identification area 342 for identifying the player currently playing blackjack at the gaming station 18. The present player area 342, includes a field having the current player's name (e.g., I. B. SMITH). However, other fields identifying the player are also contemplated by the present invention including, for example, a player identification number such as the number that may be encoded upon a player identification card used in conjunction with the card reader 216 for identifying the player.

FIG. 3 presents a second embodiment of the blackjack gaming system of the present invention. In this embodiment, the blackjack game controller 14 is substantially the same as described hereinabove. However, this controller 14 is now accessible through an Internet web site 308 so that blackjack players at Internet client nodes 318 can play blackjack on the blackjack game controller 14 via the Internet 324 (or more particularly, via the World Wide Web).

Accordingly, describing the web site 308 in more detail, it includes an Internet interface 332 for receiving and



US 6,712,702 B2

15

supplying communications between the Internet 324 and the remainder of the web site 308. The Internet interface 332, in turn, communicates with World Wide Web server 340: (a) for validating and/or initiating registration of web site users (e.g., blackjack players) at web site 308; and (b) for interpreting Internet requests for routing and/or activating web site 308 modules that can fulfill such requests. Thus, the World Wide Web server 340 may access the database system 28 for determining the registration identity of, for example, a blackjack player. Additionally, upon receiving user registration confirmation regarding an Internet (e.g., World Wide Web) request, the World Wide Web server 340 activates instantiations of modules known as common gateway interface (CGI) scripts, each CGI script 348 instantiation (or, for simplicity, each such instantiation also being referred to as a CGI script 348) being: (a) for interpreting and processing Internet requests according to the semantics of a web site 308 application associated with the CGI script; and (b) for constructing Internet responses from output from the associated application. Thus, there are one or more common gateway interface modules provided wherein each CGI script 348 (instantiation) invokes the blackjack game controller 14 to process a single Internet blackjack request from an Internet client node 318 where a player is playing blackjack, and subsequently the CGI script 348 constructs an appropriate Internet response from the output received from the blackjack game controller 14.

Since the embodiment of the blackjack game controller 14 of FIG. 3 is substantially identical to that of FIG. 1, a description of its internal structure is not repeated here. However, it is worthwhile to note that the embodiment of FIG. 3 is particularly appropriate when the blackjack game controller 14 executes on a different or remote processor from that of, for instance, the processor performing the CGI script(s) 348. Further, note that if the blackjack game controller 14 executes on the same processor as the other web site 308 modules of FIG. 3, then the communication interface 22 may be unnecessary, and additionally, much of the functionality of the other components of the blackjack game controller 14 may be incorporated into one or more CGI scripts 348. Thus, for example, the blackjack player evaluator 34 functionality may be incorporated into one CGI script 348 while house blackjack playing module 42 functionality may be incorporated into another CGI script.

There are also noteworthy distinctions between the gaming stations 18 of FIGS. 1 and 2 and the Internet client nodes 318 of FIG. 3 as well as distinctions in blackjack play interactions. For example, the following distinctions may be provided:

(7.1) Due to the potentially lengthy delays that occur on the Internet, the embodiment of FIG. 3 does not provide for automatic acceptance of a blackjack play (e.g., acceptance of an input bet or a default to a minimum ante) due to a time period expiring. Thus, the speed of play is determined by the responsiveness of each player and the responsiveness of the Internet.

(7.2) Players may play blackjack in tournaments against one another on the Internet wherein, for each tournament entered by a player, he/she receives, without cost, a predetermined number of points to use for playing in the tournament. Note that prizes may be awarded to tournament winners as incentive to play in such blackjack tournaments. Further note that the time period to complete a tournament may be substantially more lengthy than the time periods for typical blackjack tournament play. For example, a tournament may extend for 90 days since players can play at their leisure.

16

(7.3) The input keys of gaming station 18 of FIG. 1 may be also presented on the display screens of Internet client nodes 318 wherein the input buttons of gaming station 18 now become active buttons on a blackjack web page generated by the web site 308 and presented to a player at an Internet client node 318. However, note that at least the speed of play key 280 is not necessary, as mentioned in reference to the embodiment of FIGS. 1 and 2 since the speed of play is of diminished importance.

(7.4) There may be other types of information output to an Internet client node 318 in addition to the information displayed in FIG. 3. In particular, advertising information may be provided with each web site 308 response to a player regarding, for example, blackjack tournament sponsors and prizes.

In FIGS. 4A-4E, a flowchart is presented of the high level steps performed by the blackjack game controller 14 when processing player requests in either of the embodiments of FIGS. 1 or 3 for playing a novel blackjack variation wherein new eligible card representations are generated periodically regardless of whether they are dealt in a blackjack game or not and wherein the blackjack players may play the game asynchronously from one another. In step 408, the blackjack game controller 14 is initialized so that it may process blackjack player requests and output appropriate responses to each player's request. Subsequently, in step 416, the card generator module 38 commences to output at regular intervals (e.g., less than two seconds such as every 0.5 seconds) random card representations to both the blackjack player evaluator 34 and the house blackjack playing module 42. Thus, for as long as the blackjack game controller 14 is properly responding to blackjack player requests, the card generator module 38 continuously and regularly outputs card representations. Concomitantly with the actions in step 416, the remaining steps of FIGS. 4A-4E are performed. Thus, in step 424, the controller 14 waits for a (next) blackjack player input, such inputs being, for example, requests to enter a new blackjack tournament, requests to commence a new blackjack game within a tournament, requests to process a blackjack game play request, a request for information regarding the players account, and a request for help information (such as how to play blackjack).

Upon receiving a blackjack player request, in step 430 the communication interface 22 queues the request and subsequently transmits the request to the blackjack driver 26. In step 436, a determination is made as to whether the player's request is related to a current blackjack game and/or Current blackjack tournament. If not, then step 448 is encountered wherein an additional determination is made as to whether the player's request is to enter a new blackjack tournament. If so, then in step 454 the blackjack driver 26 determines a blackjack tournament and enters the player into the tournament. Note that in providing this function, the blackjack player 26 communicates with the wager accounting module 30 to confirm that the player is eligible to enter a new tournament. Thus, the blackjack driver 26 supplies the wager accounting module 30 with at least the player's identification and a specification of the tournament in which the player may be entered. Note that the tournament selection may be provided by the player in some embodiments of the present invention. Alternatively, the blackjack driver 26 may select a tournament for the player using tournament information stored in the database system 28. Assuming that the wager accounting module 30 responds with a confirmation that the player may be entered into the selected tournament, in step 458, the blackjack driver 26 creates a

US 6,712,702 B2

17

confirmation record identifying the blackjack tournament in which the player is entered. Subsequently, in step 462 the blackjack driver 26 outputs information in the confirmation record to the player at his/her Internet client node 318 (gaming station 18). Thus, in the embodiment of FIG. 3 of the present invention, the output of step 462 (and all subsequent such outputs to a blackjack player) are output from the blackjack driver 26 to the communication interface 22 for queuing until the output can be transmitted to the CGI script 348 that initiated the player request to which this output is a response. Subsequently, the output is transmitted to the World Wide Web server 340 and to the Internet interface 332 for transmitting on the Internet 324 and thereby being routed to the Internet client node 318 where the player is playing blackjack.

Following step 462, in step 466, the blackjack driver 26 enters, into the database system 28, information indicating the blackjack tournament in which the player has been entered. Note that the information entered here into the database system 28 is subsequently accessible both by the blackjack driver 26 and the wager accounting module 30 for determining the tournament(s) in which the player has been entered. Following this step, since the player's request has been processed, the flow of control loops back to step 424 to wait for the next player input from a player at an Internet client node 318 or alternatively a gaming station 18.

Returning now to step 448, if the player has not requested to enter a blackjack tournament then step 470 is encountered to process any miscellaneous blackjack player requests not related to a current blackjack game and/or blackjack tournament. For example, a player may request accounting information related to his/her blackjack gaming account. Assuming such requests are processed and responded to in this step, the flow of control again returns to step 424 to wait for a next player input.

Returning now to step 436, if the player request is related to a current blackjack and/or blackjack tournament, then step 476 is encountered wherein the blackjack driver 426 uses the player's identification (ID) provided with the request for retrieving any status information from the database system 28 regarding any current blackjack game and/or blackjack tournament in which the player may be currently involved. Subsequently, in step 480, a determination is made as to whether the player request is to commence a new blackjack game in a current tournament. If so, then in step 484 the blackjack driver 26 requests confirmation from the wager accounting module 30 that the player can commence with a new blackjack game in the current tournament. That is, the wager accounting module 30 determines whether the player has sufficient tournament credits to continue in the tournament. Following this, in step 488, the blackjack driver 26 determines whether a confirmation has been received from the wager accounting module 30. If no such confirmation is provided, then in step 492, the blackjack driver 26 outputs a message to the player at his/her Internet client node 318 (gaming station 18) indicating that no further blackjack games in the current tournament may be played by the player.

Alternatively, if in step 488 the blackjack driver 26 receives confirmation from the wager accounting module 30, then in step 494 the blackjack driver 26 creates a blackjack game record for fulfilling the player's request. Note that in creating the new blackjack game data record, the blackjack driver 26 communicates with the wager accounting module 30 to both debit the player's account for any initial ante corresponding to commencing the new blackjack game and also to output to the blackjack driver 26

18

data of this transaction for subsequently outputting to the player. Following this step, in step 496, the blackjack driver 26 requests the blackjack player evaluator 34 to provide an initial blackjack game configuration for the new blackjack game. Subsequently, in step 500, the blackjack player evaluator 34 responds with an initial blackjack game configuration, wherein this configuration includes the initial card representation for the player's hand (as shown, for example, in area 292 of FIG. 2). Note that this initial card representation is the most recent card representation provided to the blackjack player evaluator 34 by the card generator module 38. Thus, note that if two player requests to commence a new blackjack game were transmitted to the blackjack driver 26 in rapid succession, then step 500 may be performed for each of the requests before the dealer module 38 outputs a new random card representation to the blackjack player evaluator 34. Consequently, in such a case both players will be presented with an identical initial card representation for the player's hand. Subsequently, in step 504, the blackjack driver 26 stores information regarding the identity and initial configuration of the new blackjack game for the player in the database system 28. In particular, a blackjack game identifier for the new game is stored and associated with the identity of the blackjack player and the tournament, to which the game is associated. Following step 500, in step 504, the blackjack driver 26 stores information regarding the new blackjack game for the player in the database system 28. In particular, the following information is stored regarding the initial configuration of the new blackjack game: the player's identity, the identity of the tournament for which the new game corresponds, and identifier identifying the new game, and an initial configuration for the new blackjack game including card representations and any initial required bets. Further, note that throughout the course of each blackjack game played by a player, the blackjack driver 26 and the wager accounting module 30 update information in the database system 28 as the game configuration changes due to interactions between the player and the blackjack game controller 14. Thus, for a blackjack game underway, each request from a player for continuing the game with a next play, need not provide the entire game configuration to the blackjack game controller 14. Instead, only sufficient information is required in the request for the blackjack driver 26 and/or the wager accounting module 30 to retrieve information related to the blackjack game configuration corresponding to the player's request. Following step 504, in step 508, the blackjack driver 26 outputs an initial blackjack game configuration for the new game to the player at his/her Internet client node 318 (gaming station 18). Subsequently, the flow of control once again returns to step 424 to await a next player input to the controller 14.

Returning now to step 480, if it is determined here that the player request is not to commence a new blackjack game in a current tournament, then step 520 is encountered wherein a determination is made as to whether the player request is related to a play in a currently active blackjack game. If not, then in step 524 the blackjack game controller 14 processes miscellaneous requests such as, for example, a request for special blackjack rules relating to a current game and/or tournament, the number of players remaining in the current tournament, the player's ranking in the current tournament, and the prizes for winners of the current tournament. Subsequently, assuming such miscellaneous requests are responded to, in step 524, the flow of control for the present flowchart returns to 424 to await a next player input.

Alternatively, if in step 520 the player request is related to a play in a currently active blackjack game, then in step 528

US 6,712,702 B2

19

a further determination is made as to whether the player request is for a new card representation. If so, then in step 532, a determination is made as to whether the card request is for the house or for the player. If the card request is from the house, then in step 536 the blackjack driver 26 communicates with the house blackjack playing module 42 for obtaining a new blackjack game configuration for the current blackjack game, wherein the new game configuration includes the most recently output card representation from the card generator module 38 as the next card representation in the house hand for the blackjack game from which the current player's request came. Subsequently, in step 542 the house blackjack playing module 42 outputs blackjack game configuration information indicating the new house hand card representation and any player response(s) that the player may exercise in responding to the new blackjack game configuration.

Upon receiving the house blackjack playing module 42 output, in step 546, the blackjack driver 26 determines whether there is a further player response in the present game by invoking one or both of the blackjack player evaluator 34 and the blackjack hand evaluator 46. If there are additional possible player responses, then in step 550 the blackjack driver 26 outputs a blackjack game configuration to the player at his/her Internet client node 318 (gaming station 18) so that the player may exercise one of his/her available game options. Subsequently, having processed the player's request the flow of control again loops back to step 424 to await a next player input. Alternatively, if in step 546 the blackjack driver 26 determines that there are no further possible player responses, then the current blackjack game is complete and the blackjack driver 26 in step 556 activates the blackjack hand evaluator 46 for evaluating the blackjack game hands so that the blackjack hand evaluator can activate the wager accounting module 30 to update the player's account (according to the results of the blackjack game) in the database system 28. Following this step, in step 560 the wager accounting module 30 outputs to the blackjack driver 26 updated accounting information to be provided to the player. In step 564, the blackjack driver 26 outputs the results of the blackjack game and the players updated account information to the player. Also, note that the blackjack driver 26 updates the database system 28 regarding the completion of the present blackjack game as well as any further status information related to the player and the tournament to which the present blackjack game is associated. Subsequently, having processed the player's request, the flow of control again loops back to step 424 to await a next player input.

Alternatively, if in step 532 it is determined that the player's request is for a new card representation for the player, then in step 568 the blackjack driver 26 activates the blackjack player evaluator 34 for obtaining, a new blackjack game configuration for the current blackjack game, wherein the new game configuration includes the most recently output card representation from the card generator module 38 as the next card representation for the player's hand(s). Subsequently, in step 572 the blackjack player evaluator 34 determines the next blackjack play options the player may exercise for the present game and then outputs the new blackjack configuration with these options to the blackjack driver 26. Following this, the steps 546 and subsequent steps are performed as described above.

Returning now to step 528, if the player request is not for a new card representation then step 576 is encountered wherein the blackjack game controller 14 processes other blackjack player game requests such as requests for addi-

20

tional bets, cancellations of bets, a request to stand on a particular player hand, a request to split a pair of card representations, or a request for insurance. Assuming, that such requests as described above are processed, in step 580 the blackjack driver 26 subsequently outputs a new blackjack game configuration to the player according to the processing performed in step 576. Also, note that the blackjack driver 26 updates the database system 28 with information relating to the new blackjack game configuration so that it may be retrieved upon a subsequent player request relating to the present game. Following this step, the flow of control for the present flowchart loops back to step 424 to again wait for another player input.

FIG. 5 presents a simple example of the operation of the present invention for playing blackjack wherein four blackjack games are shown being played asynchronously with the blackjack game controller 14. To describe FIG. 5 in detail, note first that the row of numbers 604 across the top of the figure represents a sequence of values of successive card representations output by the card generator module 38. That is, in a first time interval a card representation having a value of three is output, in a second time interval a card representation having a value of five is output, in a third time interval a card representation having a value of seven is output and so on across the row. Below row 604 are blackjack game rows 606, wherein each blackjack game row 606 represents a series of events that occur in each blackjack game 610 through 626 over the course of time corresponding, to the series of card values 604. In particular, the numerical entries within each blackjack game row 606 correspond to the values of the player and house card hands as additional cards are added to the player and house hands of each blackjack game. For example, referring to blackjack game row 610, assuming this blackjack game commences with the player's hand obtaining the card representation for the leftmost card value of the sequence 604 (i.e. the value three), the player's hand has a corresponding value of three. Subsequently, if the house blackjack playing module 42 is activated for this game to output (i.e. deal) an initial card representation to the house during the second time interval (i.e. the card generator module 38 has output a card representation of five), then the house hand initially has a value of five. Subsequently, if in the third interval the player for blackjack game 610 provides a request for another card, then the card representation corresponding to the value of seven in sequence 604 is provided to the player and therefore the player's hand has a total value of ten. Following the incorporation of the seven into the player's hand, this blackjack game is delayed so that the next time interval corresponding to the value of two in sequence 604 is not dealt to either the player or the house in blackjack game 610. Note that it is an important aspect of the present invention that card representations generated by the card generator module 38 are only incorporated into a particular blackjack game when a request for such a card representation is made during the time the card representation is the most recent output from the card generator module 38. Thus, one or more card representations output by the card generator module 38 during a blackjack game may not be used in the game. More precisely, it is typical (although not shown in the example of FIG. 5) that substantially any length or subsequence of consecutive card representations output by the card generator module 38 may be ignored within a given blackjack game due to time delays occurring in the game. Thus, in some circumstances such delays could be as long as a number of days if the player, for example, did not request another hit during such a time interval.

US 6,712,702 B2

21

Continuing now with the remaining plays of blackjack game **610**, note that in the fifth time interval the player requests a hit thereby obtaining a card representation having a value of nine and thus obtaining a player's hand value of nineteen. Subsequently, the house takes hits for the next two consecutive card representations having values eight and ten respectively. Thus, the house hand busted when the value of twenty-three was obtained for the house hand.

Blackjack game rows **606** for blackjack games **614** through **626** may be interpreted similarly to the description above for blackjack game **610**. Note however that each of these games commence at a different time interval in that each game commences with a different card representation taken as the first hit for the player's hand. That is, the first card representation dealt in each of the blackjack games **610** through **626** is different and further each of the card representations requested corresponding to values of the sequence **604** is different for each blackjack game. Therefore, substantially every blackjack game, even if played concurrently with other blackjack games, will have unique player hands and house hands. Thus, not only can a large number of asynchronous blackjack games be played simultaneously head-to-head with the house, but also there may be a greater degree of confidence by the blackjack players that the house is not manipulating card representations in that blackjack players may substantially determine the timing for substantially all hits in a blackjack game (for both the player hand and the house hand) and thereby reduce any suspicions that the card representations are being manipulated. Moreover, in one embodiment, the players may request the sequence of card representations that were generated during the course of a game.

Note that the present invention also may include other blackjack variations as well. In particular, referring to step **416** (FIG. **4A**) again, instead of generating card representations at regular intervals, this step may simply activate the card generator module **38** so that it generates a substantially random card representation on demand whenever a request for a new card representation is made (e.g., steps **536** and **568**).

Additionally, in another blackjack variation, particularly suited for tournament blackjack where each player can be monitored, the players play each play of a blackjack game synchronously as blackjack is typically played with a human dealer in casinos. However, in the present variation, each player is provided with the identical card representations for their initial cards. Subsequently, each player hand and the house (i.e., dealer) hand varies between players only when players play their blackjack hands differently. That is, for each synchronously played blackjack game among a plurality of players, the same sequence of card representations is available to each player and the house blackjack playing module **42** so that, for example, the dealt card representations in each game between one of the players and the house blackjack playing module are identical for players playing the same sequence of plays throughout the game. Accordingly, as one skilled in the art will appreciate, for each blackjack game, it may be necessary for the card generator module **38** to maintain a predetermined sequence (or ordered collection) of card representations throughout the game so that players playing differently may be dealt an appropriately sequenced card representation. Moreover, it may also be necessary for the house blackjack dealer playing module **42** to provide sufficient control information to the card generator module **38** so that the card generator module can respond with the appropriate card representation from the predetermined sequence.

22

Another embodiment of the present invention is presented in FIGS. **6A** and **6B**, wherein this embodiment is enhanced for presenting sponsor or advertiser product and/or service advertising to qualified players that adequately match a predetermined player profile such as a demographic profile of a particular group of players. Accordingly, in FIGS. **6A** and **6B**, there is a game/advertisement controller **604** for providing substantially the same functionality as the blackjack game controller **14** (FIG. **3**) except that games other than blackjack may also be played (such as poker, craps, pai gow and roulette). Additionally, the game/advertisement controller **604** also performs functions related to matching particular advertising with the users (i.e., players) playing the various games provided by the game/advertisement web site **308**, wherein each user communicates with the web site **308** on a corresponding Internet client node **318** (alternatively interactive cable television node). That is, the present FIGS. **6A** and **6B** present the high level modules for matching players having desired user characteristics (e.g., profiles) with advertising from sponsors or advertisers requesting players with such user characteristics. In particular, only the players with such desired profiles qualify for receiving a particular advertisement and/or promotional (i.e., advertising) from a particular sponsor or advertiser. Accordingly, it is an aspect of the present invention that various criteria may be used to make such a determination as to which players (or, more generally, users) receive which advertising. For example, one or more of the following attributes may be used in matching users with advertising presentations:

- (8.1) age,
- (8.2) sex,
- (8.3) financial status,
- (8.4) location or residence,
- (8.5) education,
- (8.6) marital status,
- (8.7) amount of recreational time,
- (8.8) personal tastes and/or habits (e.g., smoker/non-smoker, preferences for sports, movies, liquor, foods, clothes, vacations, cars, etc.),
- (8.9) size of household,
- (8.10) number of children, and
- (8.11) categorizations of users according to network interactions such as the type of web sites accessed, the type of advertising for which the user seeks additional information, the risk tolerance in playing games such as blackjack.

To provide (or, match) particular users with particular advertising, data (or user information items) on each user is maintained in the form of a user profile in the user (player) database **28** which is an enhanced version of the blackjack player registration and playing status database **28** of FIG. **3**. The user profiles are populated with such user related information as in (8.1) through (8.11). This information is obtained when users register at the web site **308** when users respond to explicit questions subsequently asked of them, or by monitoring the network activities of users. Note that user profiles may vary in length, depending on the amount of information obtained on each user. Moreover, different types of information may be obtained for different types of users. For example, for users having assets of more than one million dollars, these users may be requested to enter their favorite vacation destination location since this may be important for certain advertisers. However, for users whose assets are less than forty thousand dollars, no such infor-

US 6,712,702 B2

23

mation may be obtained since the information would be likely irrelevant to any advertiser. Thus, in one embodiment of the user profiles, each user profile has a variable length section for storing user information items not uniform across all users. Moreover, in such an embodiment, each user information item stored in the variable length section may be considered as a pair, wherein the first component of each pair indicates or references a question, user attribute, or user classification to which the second component provides an answer or value related to the first component. Thus, for example, for a particular user, an information item may provide the pair: (4, "Madrid"), wherein "4" identifies the attribute: "favorite vacation destination location," and "Madrid" is the value for this attribute, as one skilled in the art will understand.

Alternatively, data related to the advertisers or sponsors may reside in a different database, the advertiser database 612. Accordingly, this database stores demographic profiles which, in one embodiment, have a data structure substantially identical to the user profile data structure. Such demographic profiles may have a variable length section for specifying requested values for user information items that may be provided in (potentially only a relatively small, number of) user profiles. In some embodiments, a demographic profile includes a reference to the advertiser's or sponsor's identity, a reference to the advertising to be presented and a variable length section of demographic item pairs, wherein the first component of each pair has the same interpretation as the first component of a user information item pair and the second component of the pair specifies a desired value or range of values that the advertiser or sponsor prefers. Further, note that, in some embodiments, each demographic item pair may have additional information associated with it such as a perceived importance of the demographic item pair to the advertiser or sponsor. Thus, such additional information may be in the form of a normalized scalar value wherein a value of one indicates that the demographic item pair is of highest importance whereas a value of zero indicates that the demographic item is substantially irrelevant to the advertiser or sponsor. Accordingly, regardless of the particular embodiment of the demographic profiles, the users' demographic profiles are used to match (i.e., select) one or more corresponding advertising presentations with a particular target group of users that, presumably, are likely to purchase the product and/or service portrayed in such advertising presentations. Thus, since such advertising presentations may be provided to only users who are likely to be subsequent customers, advertisers and/or sponsors may provide to these users specifically targeted advertising having relatively expensive promotionals such as product or service discounts, free samples, or a trial usage.

Accordingly, to perform the selecting or matching of users with such demographic profiles, for each user, the user profiles stored in the user database 28 are compared with the demographic profiles by the advertising selection engine 618. Note that there are numerous techniques for performing such a comparison for selecting a group of users. In particular, a precise match may be required between each demographic item pair and a corresponding user information item pair so that the second component of the user information item pair is (within) a desired range as specified in the corresponding demographic item pair. Alternatively, various weighting statistical techniques may be used for determining a "similarity" measurement when not all demographic pairs are required to precisely match a demographic profile. In one embodiment, the similarity measurement may

24

be provided by a statistical analysis module that determines the users that most closely match the corresponding demographic profile for an advertising presentation. Thus, in order for a user to be selected, the similarity measurement between the user's profile and a corresponding demographic profile may be required to be above a predetermined threshold. Additionally, note that the advertising selection engine 618 may perform the matching of users with advertising presentations as a background or non-real time process so that, for example, for each user profile in the user database 28, there is a related table identifying the advertising presentations that are candidates for presentation to the corresponding user when, for instance, this user communicates with the game/advertisement web site 308.

Moreover, it is important to note that at least in one embodiment of the present invention, the advertising selection engine 618 may, for a particular demographic profile, periodically re-evaluate user profiles in the user database 28 for reselecting the group of users to which an advertising presentation is to be presented. Thus, users previously selected may be requalified or disqualified and users previously disqualified may be now qualified for selection due to, for example, an enhanced user profile.

Accordingly, the present invention may commence or cease transmitting a category of advertising to a user whose user profile is enhanced with additional information. For example, if a user indicates that he/she is currently considering the purchase of a new car, then advertising for purchasing a car may be transmitted to the user. Alternatively, once the present invention is notified that, for example, a car has been purchased or that no further car advertising is desired, then a further enhancement of the user's profile may be performed so that no further advertising from the category of car advertising is transmitted to the user.

Note that the present invention provides for flexibly creating, deleting and modifying categories of advertisements by providing techniques for linking demographic item pairs that are similarly related to a category record or object. Thus, at least the following advertising categories may be provided by the present invention: sports categories (e.g., baseball, soccer, hockey, etc.), food related categories (e.g., restaurants, grocery stores, food items), exercise related advertising (e.g., bicycles, in-line skates, skiing), insurance related advertising (e.g., auto insurance, life insurance), political related advertising (e.g., for or against a particular political candidate), and geographical related advertising (e.g., for users living in a particular area such as the Denver metropolitan area). Thus, the advertising selection engine 618 supplies the selected advertising presentations to the HTML display engine 622 for translating this data so that it may subsequently be included in an HTML output to the user by the common gateway interface 348.

More precisely, the selected advertisement data is joined in the HTML display engine 622 (at least in one operation of the present invention) with a token 628 representing, for example, a gaming card (for a current user game) that has been issued by the token generator (module) 38, this generator being an enhanced version of the card generator module 38 of FIG. 3. The generated token is supplied initially to the game play engine 632 for processing user gaming requests according to the rules of the game being played. That is, the game play engine 632 determines, for each available game: (a) how each token may be "played"; (b) who receives the token, for example, the user or the house playing module 42; and (c) the result of playing the token. Note that in one embodiment, the token generator 38 generates tokens on request by, for example, the house

US 6,712,702 B2

25

playing module 42 and/or the player options evaluators 34, wherein the tokens generated are appropriate to the game being played. Alternatively, in another embodiment, the token generator 38 may generate random tokens and the game play engine 632 transforms the tokens into appropriate randomized values for the games offered, as one skilled in the art will appreciate. Furthermore, other embodiments for supplying randomized tokens to a plurality of different games are within the scope of the present invention. Additionally, the game play engine 632 contacts the player database 28 to maintain the status of the user in relation to the particular game being played as well as the user's relationship to all of the other users (if, for example, the user is involved in a tournament offered at the game/advertisement web site 308). Note that, as one skilled in the art will appreciate, in one embodiment of the game play engine 632, its internal modules provide a similar architecture and functionality to the correspondingly labeled modules of FIG. 3, albeit additionally, for games other than blackjack (e.g., "head-to-head" poker, craps, roulette, and pai gow).

The common gateway interface or CGI scripts 348 transfer data between the HTML display engine 622 and the World Wide Web server 340 which, as one skilled in the art will understand, may be a plurality of high level executable programs as discussed in the description of CGI scripts 348 for FIG. 3. The World Wide Web server 340, in turn, transfers the data to the Internet TCP/IP stack 332 that interfaces with the Internet 324 for transferring the data to an intended Internet client node 318 having an appropriate World Wide Web browser 640.

The present embodiment maintains information on the status of games being played and user responses to advertising in the user database 28. Moreover, additional advertiser specific information (e.g., desired demographic profiles, advertisements, promotional, and information related to user responses) is provided in the advertiser database 612. Accordingly, as discussed above, the demographic profiles in the advertiser database 612 may include schemas or templates having fields for designating one or more of the attributes (8.1) through (8.11). Moreover, the databases 28 and 612 may maintain records of various types of pertinent statistics such as: (a) the advertising presentations presented to each user; (b) the time, date and number of presentations of a particular advertising presentation; and (c) the detected user responses to the advertising. Thus, this information may provide advertisers or sponsors with enhanced feedback as to the efficacy of their products, services and presentations thereof. For example, an advertiser may be able to query the user and advertiser databases 28 and 612 to obtain such feedback as:

- (9.1) who has seen a particular advertisement;
- (9.2) when it was seen;
- (9.3) the number of times the advertisement was accessed:
  - (a) by any particular user;
  - (b) by all users; and
- (9.4) the number of favorable and/or unfavorable responses.

Referring now to FIG. 7, a diagram is presented providing one embodiment of the access routes or paths users navigate in accessing the features of the game/advertisement web site 308. In particular, upon initiating Internet contact with the game/advertisement web site 308, a user is first presented with the opening page 700 identifying the web site 308. Subsequently, the user can access the benefits and registration pages 704 for viewing general information related to web site 308 and also for registering at the web site (as is

26

discussed in further detail below). Alternatively, the user may access one or more "Lobby" pages 708 to view the gaming and information exchange capabilities as, for example, provided by advertisers. Assuming the user is registered at the game/advertisement web site 308, the user may proceed from the LOBBY 708 to the game page 710, wherein a game 726 or game rules 730 can be selected for playing, via the introduction to game pages 728. Alternatively, the user may instead access one or more index pages 714 having, for example, listings of organizations to which the user may be allowed to access depending on the affiliations of the user (e.g., a member of a particular membership discount store chain). Additionally, from the index page(s) 714 substantially any user may access an advertisement or promotional provided by an advertiser on an advertiser page(s) 722. However, it is an aspect of the present invention that information related to certain promotionals provided by advertisers or sponsors are restricted. That is, such promotionals may be only presented to users having a demographic Dprofile that has been determined by the present invention to be sufficiently compatible with a desired user profile for the advertiser or sponsor to warrant providing such a promotional. Thus, the present invention provides access to certain advertiser promotionals only to "qualified" users who are, for example, considered likely subsequent purchasers of the advertiser's products and/or services. Additionally, such promotionals may also be presented to users who express an interest in a particular product or service advertised. For example, users who (a) request additional or supplemental information related to an advertised item, or (b) provide a favorable response to such advertising (by, for instance, indicating a preference for an advertised item), or (c) respond to a questionnaire related to personal information or marketing survey information may also be provided with information regarding promotionals. Thus, advertisers or sponsors may offer relatively substantial or expensive promotionals via the present invention to such users as well. Moreover, the present invention may also utilize such demographic profiles to prohibit a user not sufficiently matching such a demographic profile from gaining access to a corresponding promotional. Accordingly, in one embodiment of the present invention, when the user accesses an advertiser page 722, the user's profile (in the user database 28) is compared with the demographic profiles in the advertiser data base 612 for determining any promotionals that can be presented to the user.

Moreover, from the index page 714 the user may be provided with the ability to link into various web sites or web site pages. That is, the user may be provided with the ability to link into another web site or web page at any time a link is made available (typically a hypertext link). Additionally, note that similar links may be accessible by users while playing a game 726. However, these links may generally hyperlink the user to an advertiser page 722 within the game/advertisement web site 308 so that the user may be exposed to further information and/or presented with promotional options for an advertised item. For instance, certain advertising hyperlinks may be integrated into the presentation of plays of a game 726. Accordingly, since an aspect of the present invention is to repeatedly integrate different advertising presentations (and any related hyperlinks) into the play of a game 726, a user may repeatedly be enticed to seek out additional information about different products or services by activating the related hyperlinks. Moreover, it is also an aspect of the present invention that when such hyperlinks provide the user with access to a different web site, that at least a portion of the display of the user's Internet

US 6,712,702 B2

27

client node **318** maintains a graphical format associated with the game/advertisement web site **308**, and that the user may leave and return to the web site **308** without the user being aware of accessing another web site. Moreover, by monitoring user input related to an advertising presentation, the present invention is able to provide feedback to an advertiser as to, for example, the number of times the advertising presentation is accessed by users for such additional information about products or services.

Also note that some advertisements (presented via advertiser pages **722** or as part of a game play presentation) may be interactive with the user wherein the user may perform a transaction such as making a reservation (e.g., an airline or hotel reservation). Further, a user may be given the opportunity to provide positive and negative opinions or responses on, for example, various advertisements, promotionals and other related matters by expressing such responses upon accessing advertisement related information. Thus, it is an aspect of the present invention to be able to conduct "test marketing" in that statistically representative groups of users may be selected for determining:

- (10.1) the efficacy or appeal of one advertisement in comparison to another advertisement for a particular advertised item;
- (10.2) the profile of the users that are responsive to a particular advertising presentation; and/or
- (10.3) whether a particular group of users, for example, having similar user profiles favorably respond to a particular advertising presentation. For example, the present invention may determine such a response: (a) by detecting an activation of a hyperlink, (b) by detecting a response to questions presented, and/or (c) by determining the length of time the advertising presentation is displayed or visible.

Accordingly, input response data may be transmitted to the game/advertisement web site **308** and retained for subsequent statistical evaluation. Thus, resulting aggregate statistics can be made available to, for example, advertisers or sponsors, thereby preserving the privacy of the users. In particular, statistics may be made available for:

- (11.1) providing information about, for example, the efficacy of certain advertising presentations (e.g., the number of positive responses to such presentations and/or the number of advertised items sold directly through the advertisements at the game/advertisement web site **308**);
- (11.2) providing information related to the number and profile of users accessing certain advertising presentations;
- (11.3): determining measurements related to the number of different (groups of) users to which an advertising presentation has been presented;
- (11.4) determining the total number of presentations of a particular advertisement;
- (11.5) determining the cost of advertising presentations to the advertisers and billing the advertisers for such costs according to, for example, at least one of: (a) the number of users to which an is presented, (b) the number of promotionals requested or (c) the number of network user communications (i.e., hits) with the web site **308**;
- (11.6) determining if an advertising presentation should be discontinued because the advertiser's cost limits have been reached, such limits being, for example, related to a total number of presentations of an advertising presentation. Note that, in one embodiment, it is

28

an aspect of the present invention to charge an advertiser for each presentation to a user; or

- (11.7) determining which of an advertising presentation and a different second advertising presentation (from the same advertiser) is most effective when both are provided to various selected (groups of) users, so that the advertiser or sponsor may then have a basis for choosing the most appropriate of the two advertising presentations in future advertising.

Additionally, it is an aspect of the present invention that it may also maintain statistics (and/or related information) for:

- (12.1) providing "real time" game rankings of users (players) involved in a gaming tournament provided by the game/advertisement web site **308**. Note that such rankings may be provided to a user so that he/she may know his/her standing and the number of players remaining in the tournament; and
- (12.2) providing a "style of personality" of the game playing users so that, for example, a risk tolerance of such users may be estimated and used to determine if a particular user might be interested in a particular product or service. Thus, such "style of personality" statistics for a user may be stored in the user's profile. For example, the information captured here may include: average size of wager, average size of wager in comparison to the total amount that could be wagered, length of time playing in a single session, the ratio of the number of wagers on high risk plays presented, and the skill of the player.

Accordingly, the following aspects of the present invention are noteworthy:

- (13.1) the user may be provided with free access or reduced cost access to other areas of the Internet **324** upon viewing the presentations of certain organizations and/or advertisers. Note that the ability to reduce the cost of accessing the Internet may act as a vehicle for attracting various users;
- (13.2) the index page **714** gives a user the opportunity to access a particular organization (e.g., organizations **718**) that the user may belong to or any particular advertiser (e.g., advertisers **722**) without going through any games although the user may be required to go through the "LOBBY" page(s) **708** and thereby be exposed to advertising and/or the opportunity to join a game;
- (13.3) a user may also be able to go from an initial organization page **718** to an introductory game page **728** (e.g., for a game **726**) but, unless authorized, may not be provided with further access to the organization's web pages or the game;
- (13.4) while playing a game **726**, the user has the ability to access further information related to an advertisement or promotional being presented;
- (13.5) during the playing of a game **726** (e.g., blackjack), the user may be allowed to review and/or stepwise replay a previous portion of a game **726** during a current gaming session;
- (13.6) when in a particular organization page **718**, the user may be required to return to the index page **714** before linking into an advertiser **722** unless a direct link has been provided for some reason on the particular organization web page. Moreover, the user may access the game page **710** from the index page **714** and vice versa;
- (13.7) a user may either go directly into playing a particular game **726** (as authorized) or to a rules section

US 6,712,702 B2

29

730 for reviewing the rules for the corresponding game 726. Note that a user may always access the rules section 730 during the corresponding game 726;

(13.8) there is a help feature for providing information such as:

a) how to do some particular action or the reason for some action or the reason an action is blocked. For example, the reason for an inability to access a certain web page, the reason for an inability to make a particular game play, such as a bet, stand or hit in the game of blackjack and/or the reason for a particular result of a certain bet, hit, stand or other user play in a game such as blackjack;

b) for contacting a gaming referee for resolving gaming conflicts. Such a referee will be available to resolve any dispute. Note that the user can notify the management operating the present invention of a problem via, for example, notification forms displayed when a notification button is activated.

Referring now to an alternative embodiment of the present invention presented in FIG. 8, wherein the game/advertisement web site 308 coordinates with a third party Internet access service provider 810 (or interactive cable television provider) for providing Internet 324 (cable television) access to users on a reduced cost or free basis once a user has registered with the web server 340 (cable television provider). That is, the game/advertisement web site 308 contacts the user's Internet service provider 810 and arranges to subsidize the user's Internet service charges in return for the gaming advertisement web site 308 being able to repeatedly download to the user's Internet client node 318 (or alternatively, interactive cable television node), unrequested information such as advertising for presentation to the user.

Accordingly, a prospective user of the present invention can sign up or register with the game/advertisement web site 308 for reduced Internet service fees by dialing into an Internet service provider 810 with normal serial dialing and after gaining Internet access, subsequently log on to the web site 308 as a user identified by the generic user identifier "NEW." Each user identified by "NEW" is forced into a connection with an enrollment or registration program so he/she can provide information requested by the present invention that can subsequently be used in determining which advertising to present to this user according to, for example, advertiser preferences. Thus, when registration is completed, the present embodiment of the invention downloads, for example, an ad viewer program 812 and a communications daemon (e.g., ad receiver daemon 806) to the user's Internet client node 318, wherein this daemon allows the game/advertisement web site 308 to download to the user's Internet client node 318 unrequested information such as advertising repeatedly. Accordingly, assuming the daemon 806 is installed, the user may access not only the gaming and advertisement services of the web site 308, but also access substantially the entire Internet through the web site 308 at a reduced cost. Thus, whenever the end user processor 318 connects with the Internet service provider 810, the game/advertisement web site 308 is alerted by the Internet service provider 810 and the DISPLAY ENGINE 622 starts up the downloaded daemon 806 via Internet communications with the user's Internet client node 318. Subsequently, the DISPLAY ENGINE 622 periodically sends selected advertising to the daemon 806. Accordingly, the daemon 806 utilizes the ad viewer program 812 to coordinate the display of the advertising presentation.

Note that various alternative embodiments related to the architecture and functionality of FIG. 8 are also within the

30

scope of the present invention. For example, instead of communicating with a plurality of third-party Internet service providers 806 for determining when users registered with the present invention are accessing the Internet via subsidized Internet connections, the game/advertisement web site 308 may include or be related to a dedicated Internet service provider 806 so that when a user registers with the present invention, the user is provided with a new Internet access code for the dedicated Internet service provider 806 and the user's Internet access fees may be subsidized.

However, regardless of how the present invention subsidizes Internet access, the game/advertisement controller 604 is notified whenever each subsidized user connects to the Internet or disconnects from the Internet. Additionally, certain reliability features are included in the daemon 806 and ad view program 812 for assuring that advertising is indeed presented to the user. For example, there may be periodic transmissions from each subsidized user's Internet client node 318 to the web site 308 verifying that both the daemon 806 and the ad view program 812 are active. Note that whenever any advertising is received at the user's Internet client node 318, the daemon 806 transfers the advertising to the ad viewer program 812 which, in turn, converts the transmitted information to a displayable format and forces the display of the user's Internet client node 318 to present the advertising unobscured to the user.

Additionally, note that in certain contexts the DISPLAY ENGINE 622 may transmit a message to an Internet Service Provider 806 indicating that no further Internet access will be subsidized due to a predetermined number of advertising presentation display failures.

An additional and/or alternative description of the embodiment of the present invention shown in FIGS. 8A and 8B is as follows: users may use the present invention to access the INTERNET 324 on a reduced cost or free basis, by using whatever TCP/IP SLIP/PPP package they desire and registering with the web server 308. That is, a user can sign up or register by dialing into a terminal server with normal serial dialing and log on as a user identified by the identifier "NEW." User "NEW" is then forced into a connection to an enrollment or registration program so he/she can provide information requested by the present invention. When enrollment is completed, the present invention allows the user to download a communications daemon (e.g., ad receiver daemon 806) to the user's Internet client node 318. The user may then install the daemon on their machine (Internet client node 318) and dial-up with their favorite TCP/IP package.

However, upon accessing the host 308, the user accesses basic functionality of the DISPLAY ENGINE 622 that starts up the downloaded daemon 806. The network host 308 periodically queries each active port on the terminal servers (e.g., Internet client node 318) to get the IP address and then send a short message to the daemon 806 which is listening in on a specific port. The DISPLAY ENGINE 622 may also disable access by an end user machine 318 after a certain number of failures.

Note that the host 308 periodically sends an item to the downloaded daemon 806 to display. The daemon then displays the message (advertisement) in a window (of the WWW browser 640) on the user's screen.

In another embodiment of the present invention, game tournaments may be provided, wherein the players of such a tournament play instances of a game on a communications network such as the Internet, a cable network, an interactive television network, or an intranet (such as in a casino). Such



US 6,712,702 B2

31

game tournaments provide for the playing of a plurality of instances of a game by each of a plurality of players. In general, a tournament is a multi-level structure, wherein at a first level players are grouped within the tournament into groups and the players within a group compete against one another when playing one or more instances of the game. At a higher level of the tournament, winning players from a lower level (e.g., the first level hereinabove) are partitioned into one or more groups such that for each of these new groups, the players within the group compete against one another by playing instances of the game, or, alternatively, by playing instances of a modified version wherein one or more rules of the game are changed (such as described hereinabove when discussing blackjack).

Below is a brief itemization of some of the novel tournament aspects of the present invention.

1. The participants usually register by identifying themselves in such fashion so that they may be recognized by those managing the tournament and/or the other participants as participating members of the tournament.
  - a. The participants need not register by responding to all identification questions at one time that may be provided, but instead may respond to a few questions submitted at various times while the tournament is in progress.
2. Keeping score is performed by using a numeric indication, tokens, chips, or another indication of the number of credits acquired by each participant in the tournament.
3. There are game rules set forth by which the participants acquire or lose their credits for each game involved in the tournament.
  - a. An objective by which a participant wins a tournament depends upon the participants acquiring or losing their credits within the rules of each tournament.
    - i. The participants usually have the ability to access their scores and determine their ranking in the round or tournament they are in.
    - ii. The participants may be placed into various groups wherein they operate under different rules from the other participants depending upon the group to which they were assigned.
  - b. Dice, cards or other objects may be used during the game to determine the winner(s).
  - c. The methods by which the tournament is operated may include a plurality of rounds in which the participants are divided into groups and the participants in each round compete against other participants in the round to determine the winner of the round.
    - i. A winner(s) is similarly chosen from each round until a winner(s) is determined to be the winner(s) of the tournament.
    - ii. The rounds may vary in number and size, but usually, although not necessarily, each round consists of fewer participants since only the winner(s) of each round advance into the next and final rounds.
      - (1) There may be situations in which the rules may allow one or more persons who have not participated in an earlier round to be placed into an advanced round.
  - d. The participants may or may not be questioned about their personal preferences, beliefs or attitude during the tournament, which responses may be placed into

32

a data base for further questions or qualify them to be involved in other rounds or other aspects of the tournament. Note this aspect of the invention is similar to previous embodiments of the invention described hereinabove regarding advertising during the playing of a game.

- e. The tournament may or may not include a "sudden death" or special round containing special rules for winning that differ from the rules for the tournament leading up to the special round.
- f. The game rules may allow additional participants to enter the tournament after many of the other participants have qualified to be placed into an advance round by obtaining a special score that may be related to the scores of those who did advance or by complying and satisfying any other such special rules that may allow a participant to qualify to play in a tournament that is in progress and in which most or many of the other participants are playing in an advanced round of the tournament.
- g. The rules may provide for a tournament within a tournament in which special rules may qualify the participants to play in and/or win a tournament which relates in some fashion to the participants and rules of another tournament that is already in progress.
  - i. The rules may provide for a tournament within a tournament within a tournament in the same fashion as set forth above.
  - ii. The participants may be designated as a part of a particular group wherein the success of one of the participants determines the success of the other participants in the group.
  - iii. The participants may or may not have the ability to delete themselves or to be deleted and moved from one such group to another group within the tournament(s).

The foregoing discussion of the invention has been presented for purposes of illustration and description. Further, the description is not intended to limit the invention to the form disclosed herein. Consequently, variation and modification commiserate with the above teachings, within the skill and knowledge of the relevant art, are within the scope of the present invention. The embodiment described hereinabove is further intended to explain the best mode presently known of practicing the invention and to enable others skilled in the art to utilize the invention as such, or in other embodiments, and with the various modifications required by their particular application or uses of the invention.

What is claimed is:

1. A method of playing game instances on the Internet, comprising:
  - first receiving player identification at a game playing Internet accessible node (GPIAN) for first and second players;
  - transmitting, via the Internet, from the GPIAN, first information related to communications between: (a) the GPIAN, and (b) a first Internet accessible node from which the first player communicates with the GPIAN; wherein said first information is utilized in subsequent Internet communications between the GPIAN and the first Internet accessible node;
  - wherein said first information is stored on the first Internet accessible node so that it is available in subsequent different Internet connections by the first player;
  - second receiving, via the Internet, at the GPIAN, first responsive information indicative of said first information being present on said first Internet accessible node;

US 6,712,702 B2

33

first playing with the first player a first instance of a game, wherein one or more game play representations are transmitted to the first player via the first Internet accessible node;

second playing with the second player a second instance of a game, wherein one or more game play representations are transmitted to the second player and from the GPIAN while the first player is playing the first instance;

transmitting to at least one of the first and second players, respectively, during one of said first and second games instances, a presentation substantially unrelated to plays of the one game instance, wherein said presentation is advertising a product or service;

wherein said step of second receiving at the GPIAN occurs when the first player has reconnected the first Internet accessible node to the Internet after said first information has been stored on the first Internet accessible node and said first Internet accessible node has disconnected from the Internet.

2. The method of claim 1, further comprising the following steps:

identifying at least one of the first and second players as requesting to join one of one or more game tournaments, wherein each tournament includes a plurality of instances of a game for playing by each of the players identified, wherein for each of the players, at least one of the following (a) and (b) must be satisfied for the player to complete one of the tournaments:

- (a) a predetermined number of instances of the game must be played by the player;
- (b) a predetermined amount of time must elapse between the commencement of the tournament and the termination of the tournament;

for each tournament, the following steps are performed:

- (A1) selecting the identified players to be included in the tournament;
- (A2) grouping the players into groups, wherein for each group, the players therein compete against one another in playing instances of the game;
- (A3) determining one or more winning players for each group;
- (A4) establishing a modified version of the game by changing a rule of the game while retaining another rule for the game;
- (A5) combining the winning players from different groups into one or more new groups for competing against one another in playing instances of the modified version of the game.

3. The method as claimed in claim 1 further including: for the first player, the following steps are performed:

- (A) receiving, from the GPIAN via the Internet, one or more interactive game presentations for presenting on at least a portion of a display for the first Internet accessible node, and wherein said interactive game presentations are interactive, via the Internet, between the first player and said GPIAN;
- (B) providing, to the first Internet accessible node, concurrently with at least one of the interactive game presentations, said advertising presentation;
- (C) providing to the first player over time, one or more additional advertising presentations, each said additional advertising presentation for providing information related to one of a product and a service;
- (D) receiving, via the Internet, data indicative of an action by the first player in response to one of said first and

34

said additional advertising presentations, wherein said data is transmitted:

- (i) from said first Internet accessible node, and
- (ii) to a destination node of the Internet, said destination node identified at said first Internet accessible node by a destination Internet address used for transmitting said data;

(E) transmitting to the first player, via the Internet, another presentation for presenting to the first player at said first Internet accessible node, wherein said another presentation is responsive to said step (D).

4. The method of claim 1, further including:

- (a) periodically transmitting one of said additional advertising presentations to said first Internet accessible node;
- (b) forcing a display of at least one of said presentation and said additional advertising presentations to be exposed on a display at said first Internet accessible node;
- (c) transmitting further information to said first Internet accessible node, said further information related to the product or service of the advertising presentation;
- (d) presenting said advertising presentation on said first Internet accessible node, wherein at least a portion of a display maintains a graphical format displayed prior to said present step of presenting.

5. The method of claim 1, further

generating first and second sequences of electronic card representations, respectively, for playing the first game and the second game;

wherein said first and second sequences have at least different card representations in at least one identical card representation position, in each of said first and second sequences.

6. The method of claim 1, wherein further including comparing a requested wager by the first player with an acceptable wager limit.

7. The method of claim 1, wherein said first and second players play their games via differently addressed Internet nodes for accessing said GPIAN.

8. The method as claimed in claim 7, wherein said first information includes executable instructions for receiving advertisement information via the network.

9. The method of claim 7, wherein said step of transmitting includes transmitting from one of: a World Wide Web server and an Internet interface.

10. The method as claimed in claim 7, further including repeatedly performing the following steps:

determining, for at least one of said first and second players, a corresponding opponent's play that is responsive to a play made by the at least one player, and presenting, via a transmission on the network, a presentation of the corresponding opponent's play to the at least one player.

11. The method as claimed in claim 10, wherein said opponent's play is determined without manual intervention during said opponent's play.

12. A method of playing a game on a communications network, comprising:

first receiving player identification, for first and second players, at a game playing network accessible node (GPNAN);

transmitting, via the network, from the (GPNAN, first information related to communications between: (a1) the GPNAN, and (a2) a first network accessible node from which the first player communicates with the GPNAN;

US 6,712,702 B2

35

wherein said first information is utilized in subsequent network communications between the GPNAN and the first network accessible node, and wherein said first information is stored on the first network accessible node so that it is available in a subsequent different network connection by the first player;

second receiving at the GPNAN, via the network, first responsive information indicative of said first information being present on said first network accessible node; using, by the GPNAN, said first responsive information for one or more of (b1) providing the first player with access to a service offered by the GPNAN, (b2) determining that a network transmission received at the first network accessible node will be processed in a predetermined expected manner, and (b3) determining that the first network accessible node has a predetermined program element available;

first playing, with the first player, a first game instance of a game, wherein one or more corresponding game play representations of the first game instance are transmitted from the GPNAN to the first player via the first network accessible node, wherein for at least most game plays by the first player, there is a responsive game play transmission on the network by the GPNAN; second playing with the second player a second game instance of a game, wherein one or more corresponding game play representations of the second game instance are transmitted from the GPNAN to a second network accessible node for presenting the game play representations of the second game instance to the second player, wherein the game play representations of the second game instance are transmitted to the second network accessible node while the first player is playing the first game instance;

transmitting by the GPNAN to at least the first player, additional information on the network, wherein said transmitting of said additional information has, as a consequence, a display of an advertising presentation on said first network accessible node, said display occurring concurrently with a display of one of the corresponding game play representations for playing the first game instance, said advertising presentation presenting advertising related to a purchase of a product or service;

wherein said step of second receiving at the GPNAN occurs when the first player has reconnected the first network accessible node to the network after (i) and (ii) following: (i) said first information has been stored on the first network accessible node, and (ii) said first network accessible node has disconnected from the network.

**13.** The method of claim **12**, wherein said additional information is transmitted during the playing of said first game instance.

**14.** The method of claim **13**, wherein said additional information is transmitted in a different network transmission from the transmission of the one corresponding game play representation.

**15.** The method of claim **15**, wherein said display of the advertising being made visible to the first player is not a response from an immediately previous input by the first player.

**16.** The method of claim **13**, wherein said additional information is transmitted concurrently with a response from the GPNAN to a game play transmission by the first player.

**17.** The method of claim **13**, wherein said advertising presentation accepts an input from the first player for presenting further information on the first network accessible node.

36

**18.** The method of claim **12**, further including a step of selecting said advertising presentation using a result from comparing information about the first player with information related to said advertising presentation.

**19.** The method of claim **18**, wherein said information related to said advertising presentation includes profile information for identifying a player to which said advertising presentation is to be presented.

**20.** The method of claim **18**, wherein said step of selecting includes:

accessing personal information about the first player; and using said personal information for identifying said advertising presentation (AD), wherein said personal information includes data satisfying a predetermined criteria corresponding to the AD.

**21.** The method of claim **12**, wherein said advertising presentation changes from a first display to a second display of another advertising presentation without there being an intervening input by the first player.

**22.** The method of claim **21**, wherein said step of transmitting results in, periodically, an advertising presentation currently being displayed at the first network accessible node being replaced by a display of a different advertising presentation.

**23.** The method of claim **21**, wherein said advertising presentation does not affect a change in playing the first game instance.

**24.** The method of claim **21**, wherein at least one of said advertising presentation and said another advertising presentation is capable of receiving an input from the first player for requesting additional advertising information.

**25.** The method of claim **12**, wherein for at least most game plays by the second player, there is a responsive game play transmission on the network by the GPNAN.

**26.** The method of claim **12**, wherein said step of using includes determining whether a program element downloaded in response to an input by the first player to the GPNAN is properly performing.

**27.** The method of claim **12**, wherein at least one of said steps of claim **12** includes a step of the GPNAN communicating on the network with an Internet Protocol.

**28.** The method of claim **12**, wherein the second player plays the second game at a second network accessible node that has a different network identification from the first network accessible node.

**29.** The method as claimed in claim **12**, further including a step of:

outputting, from the GPNAN, a network transmission (T) to the second player, wherein as a consequence of T, at least one interactive advertising presentation is presented to the second player.

**30.** The method of claim **29** further including providing to the second player over time, one or more additional outputs from the GPNAN, wherein as a consequence of said one or more additional outputs, one or more additional advertising presentations are presented to the second player, each said additional advertising presentation for providing information related to one of a product and a service.

**31.** The method of claim **29**, further including a step of: third receiving, via the network, data indicative of an action by the second player in response to said at least one interactive advertising presentation and said additional advertising presentations, wherein said data is transmitted:

(i) from said second network accessible node, and  
(ii) to a destination node of the network, said destination node identified at said second network acces-

US 6,712,702 B2

37

sible node by a destination network address used for transmitting said data.

32. The method of claim 31, further including a step of: transmitting to the second player, via the network, another presentation for presenting to the player at said second network accessible node, wherein said another presentation is responsive to said third receiving step.

33. The method of claim 12, wherein the first and second games are card games.

34. The method of claim 33, wherein said step of first playing includes transmitting a sequence of card representations from the GPNAN to the first player for playing said first game, wherein said sequence is not transmitted by the GPNAN to the second player for playing said second game.

35. The method of claim 34, wherein said step of second playing includes transmitting a sequence of card representations from the GPNAN to the second player for playing said second game, wherein said sequence is not transmitted by the GPNAN to the first player for playing said first game.

36. The method as claimed in claim 33, further including a step of transmitting a dealer's card hand in each of said first and second games.

37. The method as claimed in claim 12, wherein for the first and second games, and a probability of said first and second players each receiving an identical sequence of game play configurations is substantially equal to chance.

38. The method of claim 12, wherein for substantially every play of said first game by the first player there is a corresponding transmission on the network between said GPNAN and said first player, wherein said corresponding transmission occurs prior to a subsequent game play by the first player in said first game.

39. The method of claim 38, wherein for substantially every play of said second game by the second player, there is a corresponding transmission on the network between said GPNAN and said second player, wherein said corresponding transmission occurs prior to a subsequent game play by the second player in said second game.

40. The method of claim 12, further including transmitting, via the network, from the GPNAN, second information related to communications between: (a) the GPNAN, and (b) the second network accessible node, wherein said second information is utilized in subsequent network communications between the GPNAN and the second network accessible node, and wherein said second information is stored on the second network accessible node so that it is available in subsequent different network connections by the second player.

41. The method of claim 40, wherein said second information includes executable instructions for receiving advertisement information via the network.

42. The method as claimed in claim 12, further including a step of maintaining a status of each of said first and second games so that each of said first and second games are played with a same effect as if the other of said first and second games were not being played.

43. The method as claimed in claim 12, further including a step of selecting the advertising presentation using personal information supplied by the first player.

44. The method of claim 12, further including a step of providing to the first player a ranking of another player that plays a game with the GPNAN, wherein said ranking is used to determine a prize for at least one of the players being ranked.

45. The method of claim 12, wherein said step of first playing includes accessing the network at one of: a reduced network charge, and free of charge.

46. The method as claimed in claim 12, wherein said step of first playing includes storing a current configuration of said first game, and accessing said current configuration

38

using player identification data provided with a game play request received from the first player.

47. The method as claimed in claim 12, further including a step of receiving a wager request from the first player via a transmission on the network, and determining whether the wager request is acceptable.

48. The method of claim 12, wherein one or more of said steps of first and second playing include providing one or more Internet transmissions, cable television transmissions, and local area network transmissions to one of the first and second players playing, respectively, the first and second games.

49. The method of claim 12, further including playing of a third game between said GPNAN and the second player, wherein a third collection of one or more game play representations is transmitted to the second player, and wherein the transmissions of the game play representations for the third collection and the first collection overlap in time.

50. The method of claim 12, further comprising the following steps:

identifying at least one of the first and second players as requesting to join one of one or more game tournaments, wherein each tournament includes a plurality of instances of a game for playing by each of the players identified, wherein for each of the players, at least one of the following (a) and (b) must be satisfied for the player to complete one of the tournaments:

- (a) a predetermined number of instances of the game must be played by the player;
- (b) a predetermined amount of time must elapse between the commencement of the tournament and the termination of the tournament;

for each tournament, the following steps are performed:

- (A1) selecting the identified players to be included in the tournament;
- (A2) grouping the players into groups, wherein for each group, the players therein compete against one another in playing instances of the game; and
- (A3) determining one or more winning players for each group.

51. The method of claim 50, further including for at least one of the tournaments:

establishing a modified version of the game by changing a rule of the game while retaining another rule for the game; and

combining the winning players from different groups into one or more new groups for competing against one another in playing instances of the modified version of the game.

52. An apparatus for playing a game on a communications network, comprising:

a store for storing player identification, for first and second players, said store accessible by a game playing network accessible node (GPNAN);

a network interface for transmitting, via the network, from the GPNAN, first information related to communications between: (a1) the GPNAN, and (a2) a first network accessible node from which the first player communicates with the GPNAN;

wherein said first information is utilized in subsequent network communications between the GPNAN and the first network accessible node, and wherein said first information is stored on the first network accessible node so that it is available in a subsequent different network connection by the first player;

wherein said network interface receives, via the network, first responsive information indicative of said first information being present on said first network accessible node;

US 6,712,702 B2

39

wherein said first responsive information is used for one or more of: (b1) providing the first player with access to a service offered by the GPNAN, (b2) determining that a network transmission received at the first network accessible node will be processed in a predetermined expected manner, and (b3) determining that the first network accessible node has a predetermined program element available;

a game controller for playing a first game instance of a game with the first player, wherein one or more corresponding game play representations of the first game instance are transmitted from the GPNAN to the first player via the first network accessible node, wherein for at least most game plays by the first player, there is a responsive game play transmission on the network by the GPNAN;

wherein said game controller plays a second game instance of a game with the second player, wherein, one or more corresponding game play representations of the second game instance are transmitted from the GPNAN to a second network accessible node for presenting the game play representations of the second game instance to the second player, wherein the game play representations of the second game instance are transmitted to the second network accessible node while the first player is playing the first game instance;

one or more programmatic elements for combining advertising related information with game playing information to obtain a resulting combination that is in a format: (a) acceptable for being transmitted on the network by the GPNAN to at least the first player, and (b) processed by the first network accessible node so that, as a consequence of such processing, a display of an advertising presentation on said first network accessible node is provided, said display occurring concurrently with a display of one of the corresponding game play representations for playing the first game instance, said advertising presentation presenting advertising related to a purchase of a product or service;

wherein said GPNAN receives said first responsive information for identifying the first player, and said GPNAN receives said first responsive information when the first player has reconnected the first network accessible node to the network after (i) and (ii) following: (i) said first information has been stored on the first network accessible node, and (ii) said first network accessible node has disconnected from the network.

**53.** An apparatus for a service on a communications network, comprising:

a store for storing user identification, for first and second users, said store accessible by a service providing network accessible node (SPNAN);

a network interface for transmitting, via the network, from the SPNAN, first information related to communications between: (a1) the SPNAN, and (a2) a first network accessible node from which the first user communicates with the SPNAN;

wherein said first information is utilized in subsequent network communications between the SPNAN and the first network accessible node, and wherein said first information is stored on the first network accessible node so that it is available in a subsequent different network connection by the first user;

wherein said network interface receives, via the network, first responsive information indicative of said first information being present on said first network accessible node;

40

wherein said first responsive information is used for one or more of: (b1) providing the first user with access to a service offered by the SPNAN, (b2) determining that a network transmission received at the first network accessible node will be processed in a predetermined expected manner, and (b3) determining that the first network accessible node has a predetermined program element available;

a controller for providing access to an instance of a first service to the first user, wherein one or more corresponding service display representations of the first service are transmitted from the SPNAN to the first user via the first network accessible node, wherein at least most of the service display representations are interactive with the first user for providing corresponding responsive transmissions on the network via the SPNAN during the instance of the first service;

wherein said SPNAN provides a second instance of a service with the second user, wherein one or more corresponding service representations for the second instance are transmitted from the SPNAN to a second network accessible node for presenting the service representations of the second instance to the second user, wherein the service representations of the second instance are transmitted to the second network accessible node while the first user is interacting with the instance of the first service;

one or more programmatic elements for combining advertising related information with service related information to obtain a resulting combination that is in a format: (a) acceptable for being transmitted on the network by the SPNAN to at least the first user, and (b) processed by the first network accessible node so that, as a consequence of such processing, a display of an advertising presentation corresponding to said advertising information is provided on said first network accessible node, said display occurring concurrently with a display of one of the corresponding service representations for the instance of the first service, said advertising presentation presenting advertising related to a purchase of a product or service;

wherein said SPNAN receives said first responsive information for identifying the first user, and said SPNAN receives said first responsive information when the first user has reconnected the first network accessible node to the network after (i) and (ii) following: (i) said first information has been stored on the first network accessible node, and (ii) said first network accessible node has disconnected from the network.

**54.** The method as claimed in claim 53, wherein when the network is the Internet, each of the instance of the first service and the second instance is one or more of:

(a) a game; and

(b) substantially any interactive service available on the Internet through an Internet service provider by which the user accesses the Internet, such that when the user connects to the Internet, said Internet service provider provides a communication to a predetermined website that subsequently transmits said said advertising information to said first network accessible node.

\* \* \* \* \*