



US007240025B2

(12) **United States Patent**  
**Stone et al.**

(10) **Patent No.:** **US 7,240,025 B2**  
(45) **Date of Patent:** **Jul. 3, 2007**

(54) **INTERNET ADVERTISING SYSTEM AND METHOD** 5,845,261 A 12/1998 McAbian

(76) Inventors: **Lucinda Stone**, 6610 Regal Bluff, Dallas, TX (US) 75240; **Michael A. Dean**, 6610 Regal Bluff, Dallas, TX (US) 75240 (Continued)

**FOREIGN PATENT DOCUMENTS**

(\*) Notice: Subject to any disclaimer, the term of this patent is extended or adjusted under 35 U.S.C. 154(b) by 0 days. IP 408249326 8/1996 (Continued)

(21) Appl. No.: **10/954,820** **OTHER PUBLICATIONS**

(22) Filed: **Sep. 30, 2004** White, Ron, How Computers Work, Millennium Ed., Que Corporation, Sep. 1999.\*

(65) **Prior Publication Data** (Continued)  
US 2005/0044009 A1 Feb. 24, 2005

**Related U.S. Application Data**  
*Primary Examiner*—Andrew J. Fischer  
(74) *Attorney, Agent, or Firm*—Henry Croskell

(63) Continuation of application No. 10/165,091, filed on Jun. 7, 2002, now Pat. No. 6,829,587, which is a continuation of application No. 09/480,303, filed on Jan. 10, 2000, now Pat. No. 6,446,045. (57) **ABSTRACT**

(51) **Int. Cl.**  
**G06Q 30/00** (2006.01)  
(52) **U.S. Cl.** ..... 705/26; 705/14  
(58) **Field of Classification Search** ..... 705/25, 705/27, 14  
See application file for complete search history.

(56) **References Cited**  
**U.S. PATENT DOCUMENTS**  
5,193,056 A 3/1993 Boes  
5,214,793 A \* 5/1993 Conway et al. .... 455/500  
5,233,423 A \* 8/1993 Jernigan et al. .... 348/564  
5,543,856 A \* 8/1996 Rosser et al. .... 348/578  
5,581,461 A 12/1996 Coll et al.  
5,684,918 A 11/1997 Abecassis  
5,724,520 A 3/1998 Goheen  
5,794,207 A 8/1998 Walker et al.  
5,797,126 A 8/1998 Helbling et al.

An internet advertising system and method that provides a seller self-serve control for creation, publication, and display of advertisements on internet media venues owned or controlled by entities other than the seller in a form automatically modified to comply with the media venues' presentation rules, which may include design or style standards for "look and feel," editorial standards, and distribution factors. Self-serve, menu driven interfaces are provided for sellers to target internet media venues, and for internet media venues to enter their presentation rules. An ad modification engine processes or customizes the advertisement for publication and display on each internet media venue in compliance with the media venue's presentation rules. The system also includes an online reporting tool, an interface for a seller's accounting management system to automatically update advertisements and control publication timing, and a buyer interface for purchase, reservation, or referral regarding the advertised product or service.

**397 Claims, 35 Drawing Sheets**

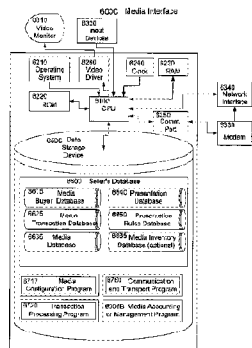

**US 7,240,025 B2**

Page 2

U.S. PATENT DOCUMENTS

5.878,141 A 3/1999 Daly et al.  
 5.884,277 A 3/1999 Khosla  
 5.893,076 A 4/1999 Ilafner  
 5.933,811 A 8/1999 Angles et al.  
 5.946,646 A 8/1999 Schena et al.  
 5.991,735 A 11/1999 Gerace  
 6.026,371 A 2/2000 Beck et al.  
 6.038,545 A 3/2000 Mandeberg  
 6.064,967 A 5/2000 Speicher  
 6.073,105 A 6/2000 Sutcliffe et al.  
 6.112,192 A 8/2000 Capck  
 6.119,101 A 9/2000 Peckover  
 6.138,142 A 10/2000 Linsk  
 6.167,382 A 12/2000 Sparks et al.  
 6.182,050 B1 1/2001 Ballard  
 6.191,780 B1 2/2001 Martin et al.  
 6.285,987 B1 9/2001 Roth et al.  
 6.324,519 B1 11/2001 Eldering  
 6.385,592 B1 5/2002 Angles et al.  
 6.397,246 B1 5/2002 Wolfe  
 6.401,075 B1 6/2002 Mason et al.  
 6.430,603 B2 8/2002 Hunter  
 6.430,605 B2 8/2002 Hunter  
 6.442,577 B1 8/2002 Britton et al.  
 6.446,045 B1 \* 9/2002 Stone et al. .... 705/26  
 6.460,036 B1 10/2002 Herz  
 6.466,975 B1 10/2002 Sterling  
 6.487,538 B1 11/2002 Gupta et al.  
 6.526,575 B1 2/2003 McCoy et al.  
 6.553,178 B2 4/2003 Abecassis

6,560,578 B2 5/2003 Eldering  
 6,567,854 B1 5/2003 Olshansky et al.  
 6,654,725 B1 11/2003 Langheinrich et al.  
 6,718,551 B1 4/2004 Swiz et al.  
 6,829,587 B2 \* 12/2004 Stone et al. .... 705/26  
 6,880,382 B1 5/2005 Anderson  
 6,892,226 B1 5/2005 Tso et al.  
 6,931,591 B1 8/2005 Brown et al.  
 2001/0011226 A1 8/2001 Greer et al.

FOREIGN PATENT DOCUMENTS

WO WO/01/37119 11/1999

OTHER PUBLICATIONS

Gralla, Preston, How the Internet Works, Millennium Ed., Que Corporation, Sep. 1999.\*  
 "Groups set to unveil Web ad guidelines" Dec. 9, 1996, Advertising Age, vol. 67, No. 50, p. 1.  
 "ABC formally launches Reader Profile Service as NAA unveils the NICC's silhouette" Aug. 2, 1999, Newsinc, vol. 11, No. 1.  
 Hamblen, Matt, "Shell protects brand via net" Jan. 10, 2000, Computerworld, vol. 34, No. 2, p. 39.  
 www.nationwideadvertising.com About 65 pages taken from the web site as of Mar. 27, 2003.  
 Kenneth S. Roberts, Declaration, Document, Feb. 10, 2006, pp. 1-8, Los Angeles California.  
 Presstime Magazine, NEXPO 97 Report. Copyright 1997, Newspaper of America.

\* cited by examiner

Fig. 1a

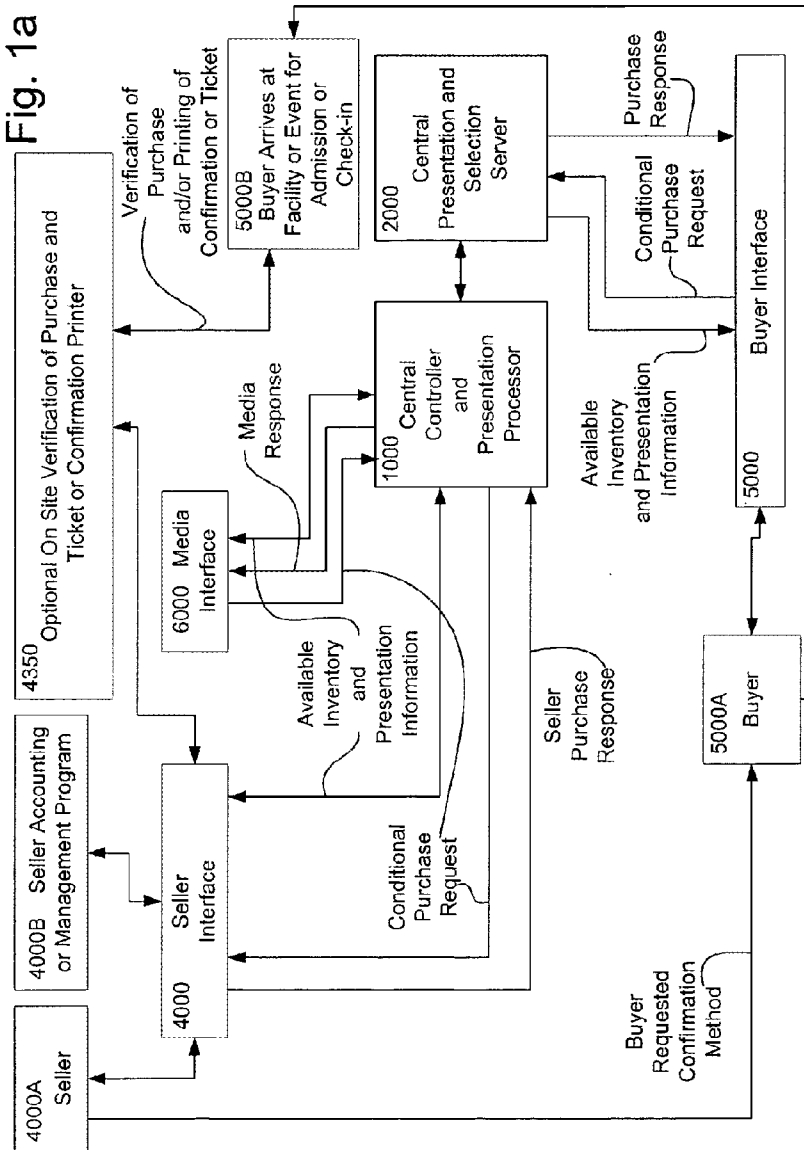

Fig. 1b

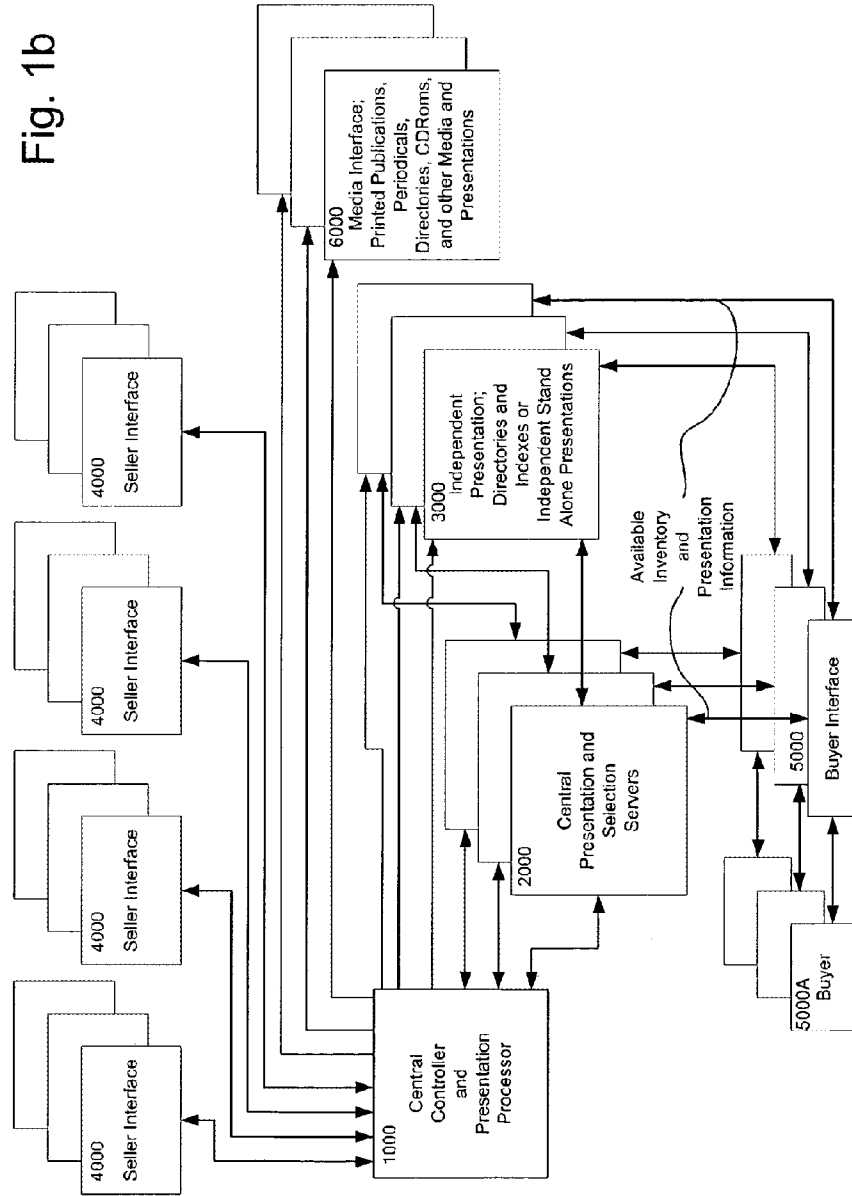

Fig. 2a

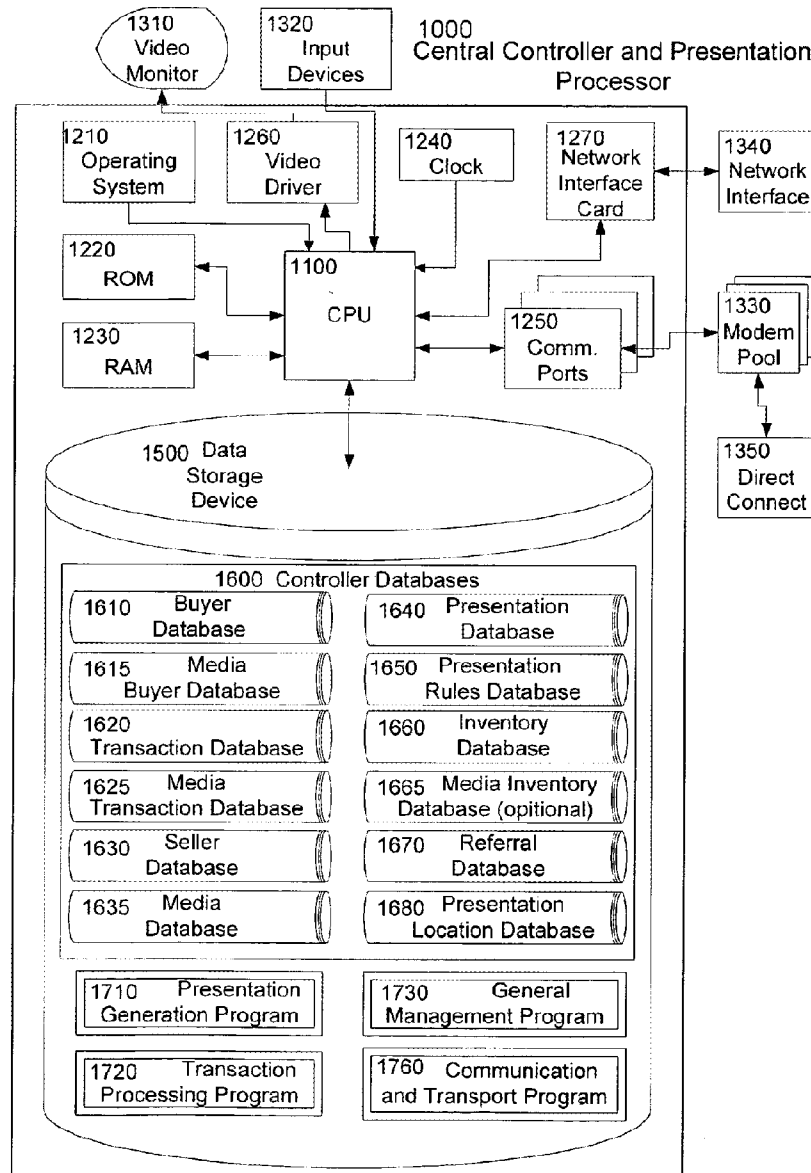

Fig. 2b

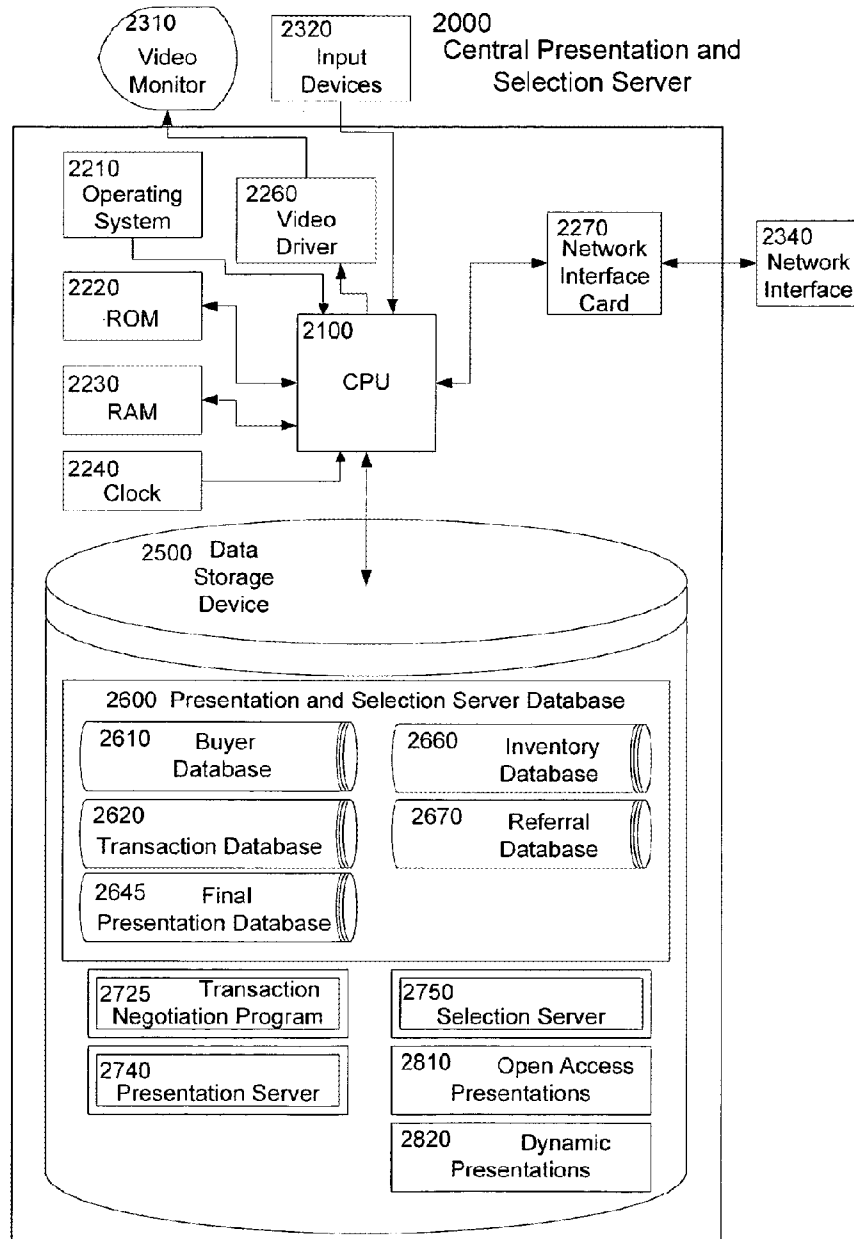

Fig. 2c

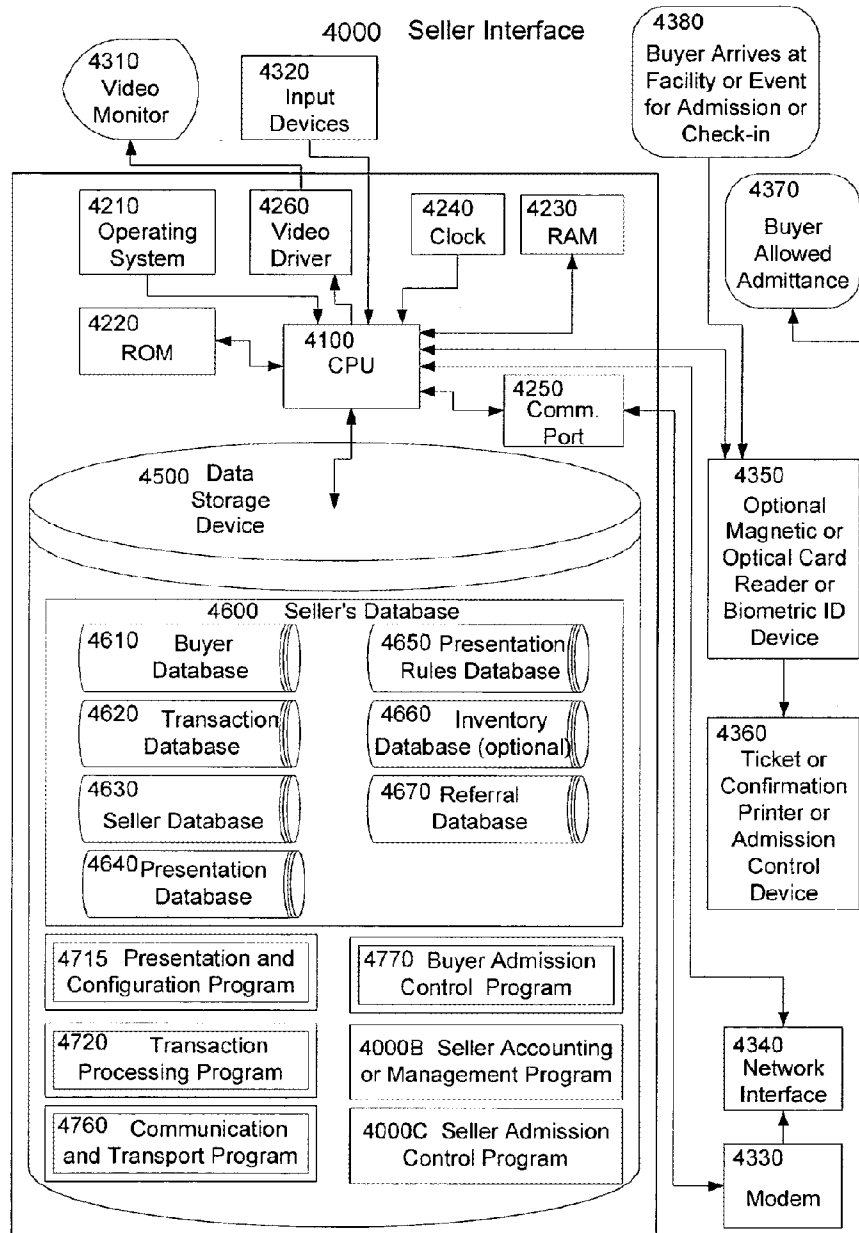

Fig. 2d

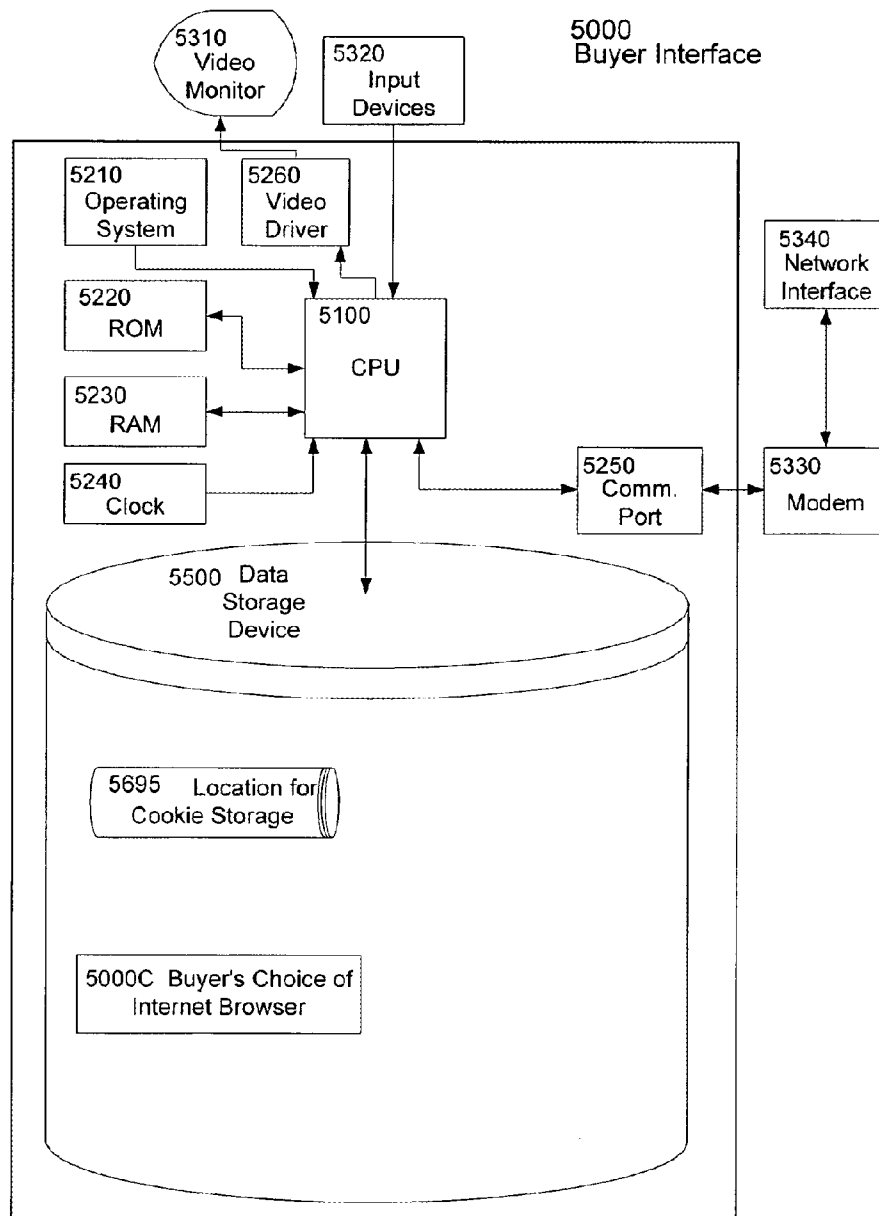



Fig. 2e

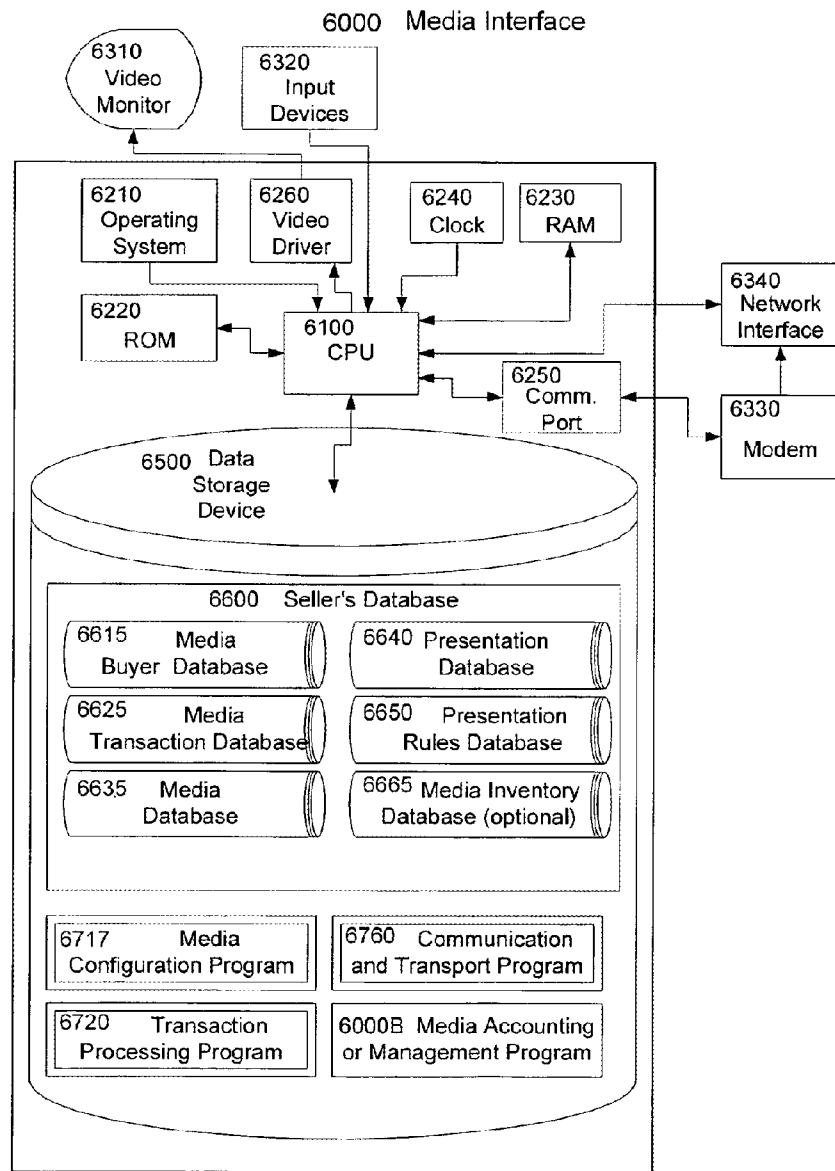

Fig. 3a

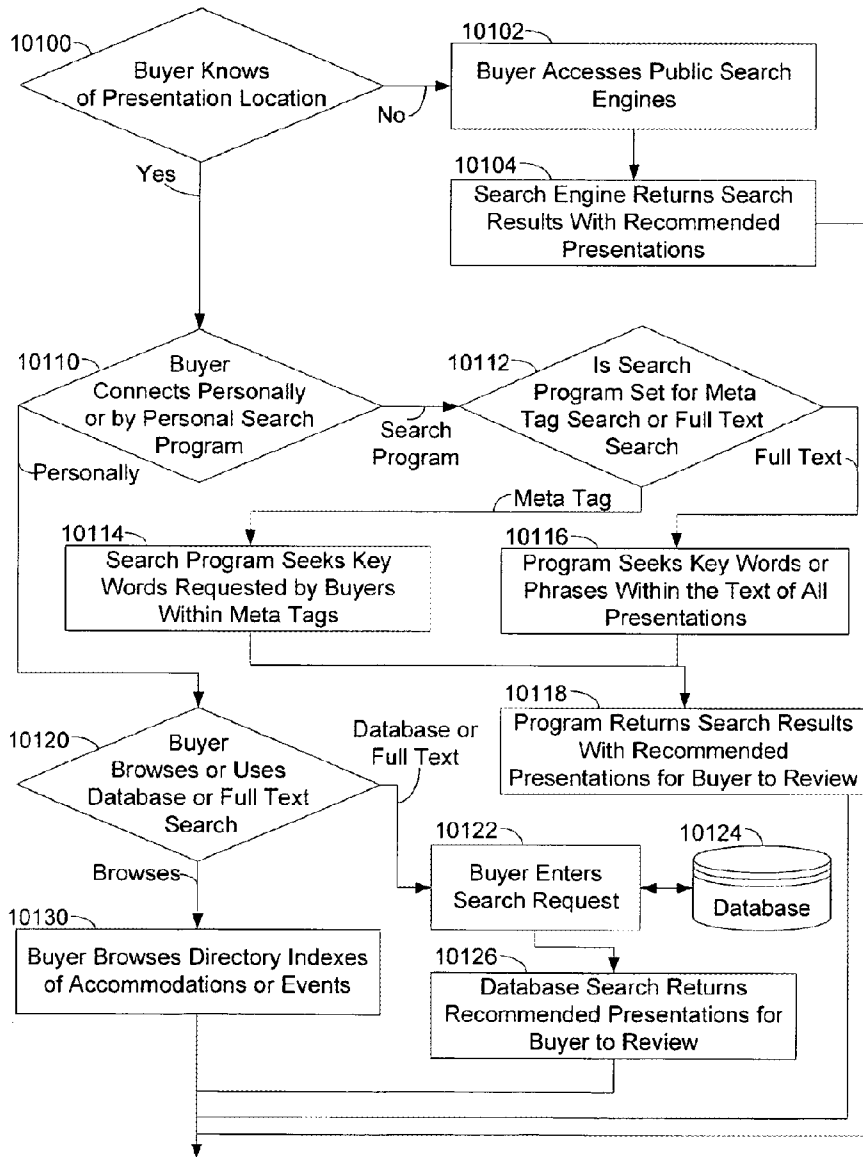

Fig. 3b

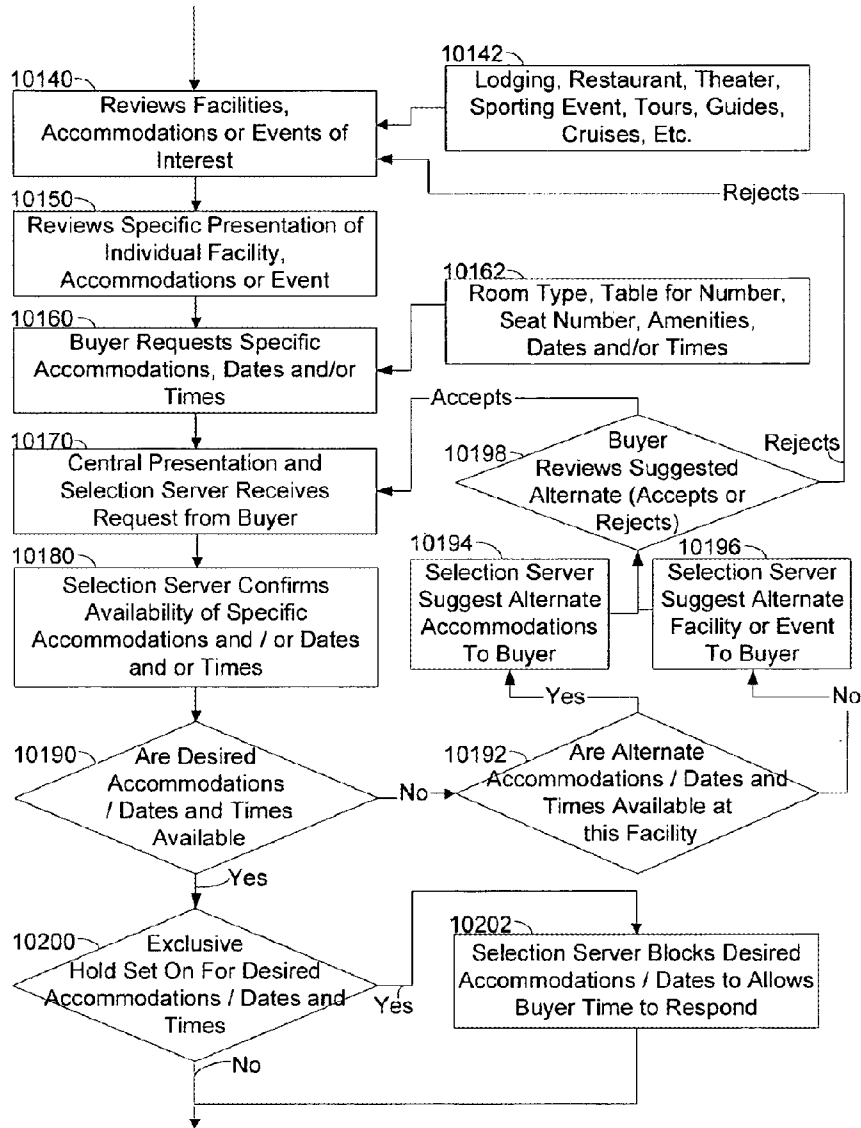

Fig. 3c

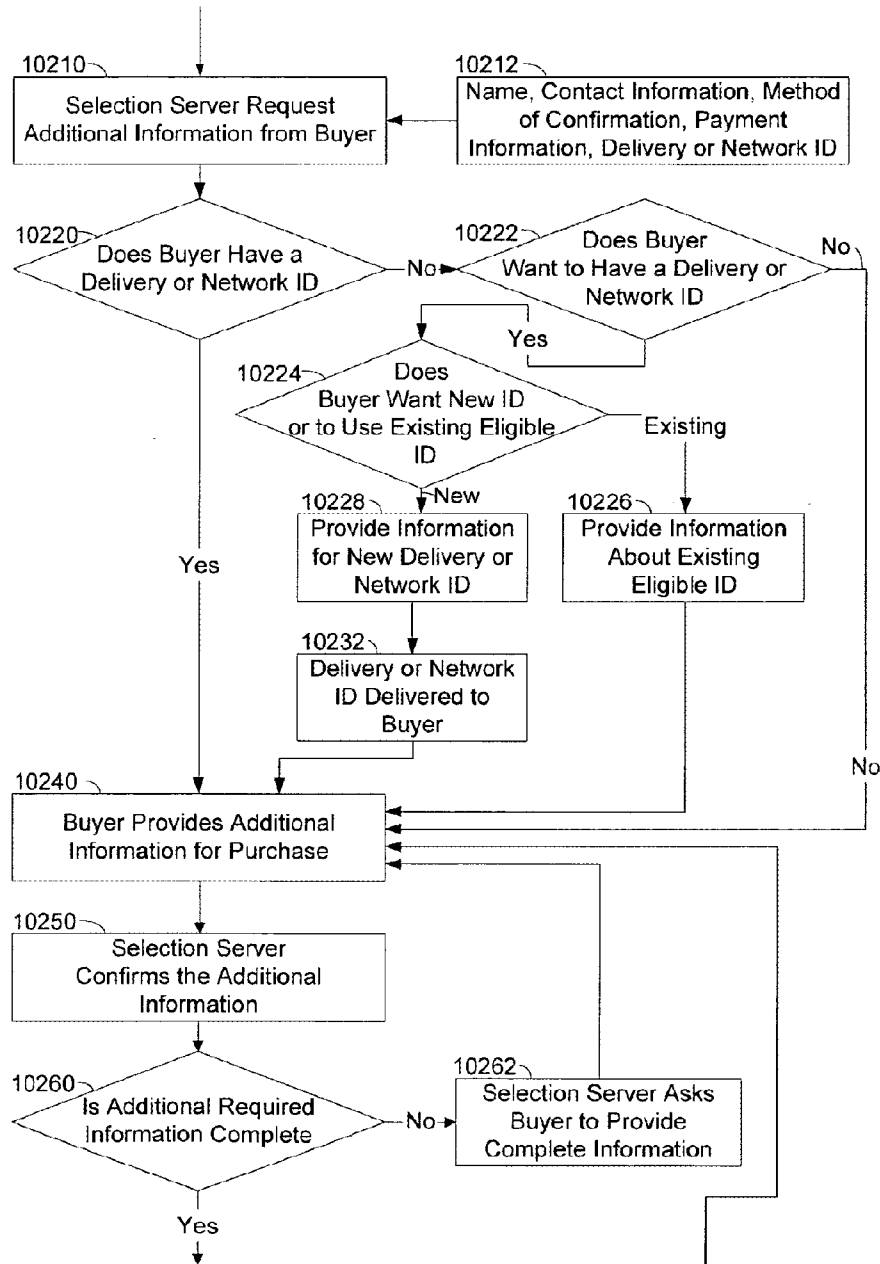

Fig. 3d

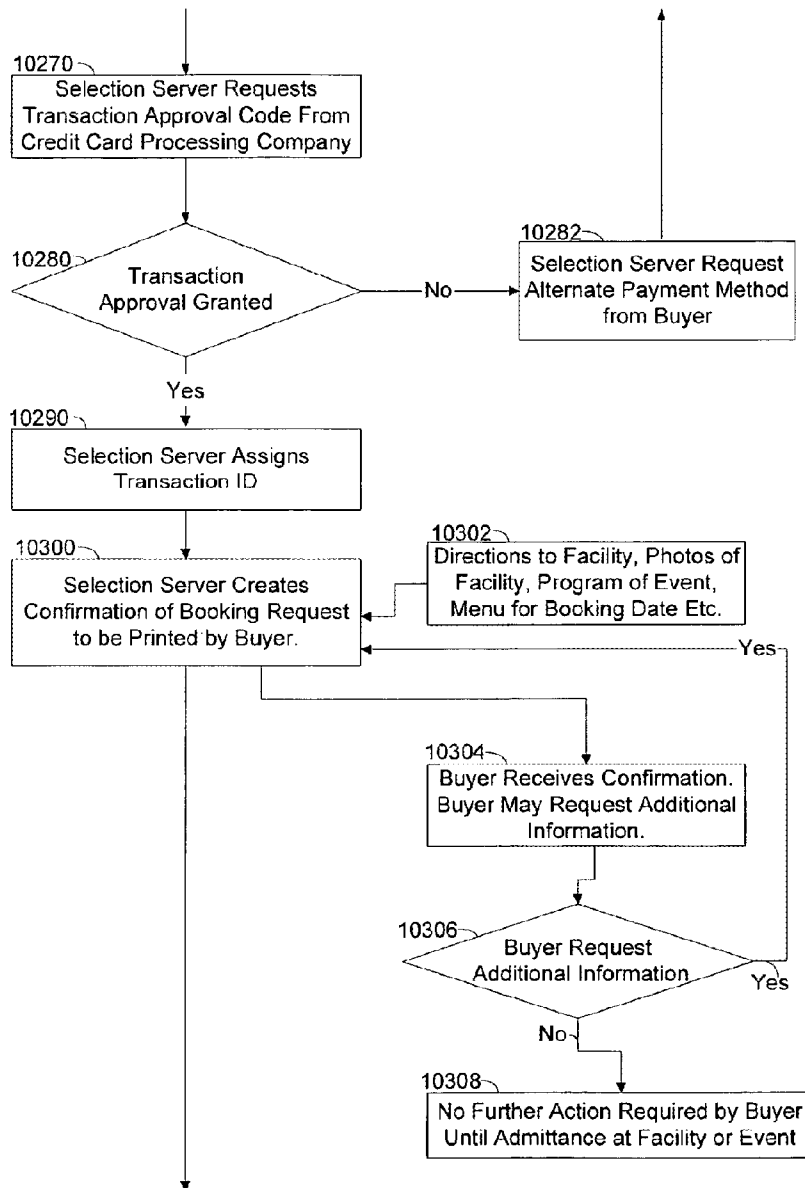

Fig. 3e

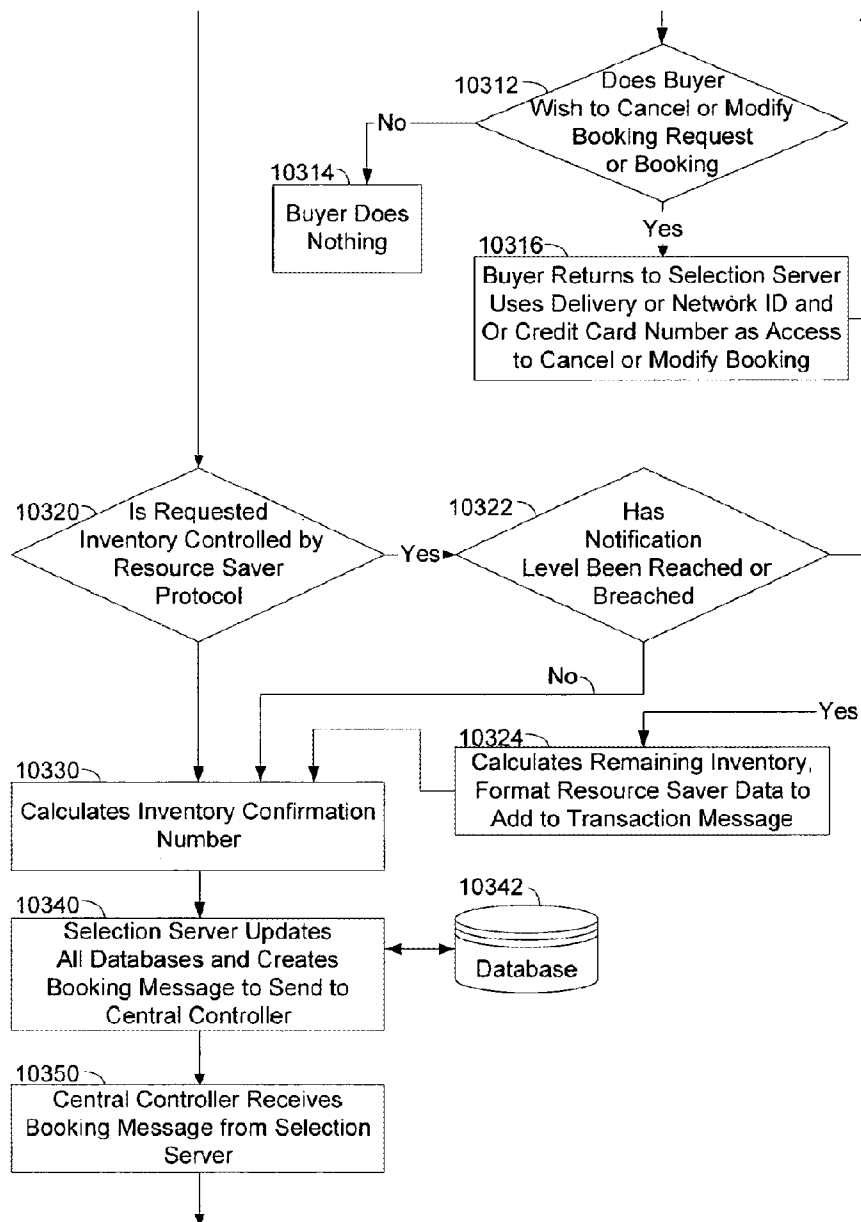

Fig. 3f

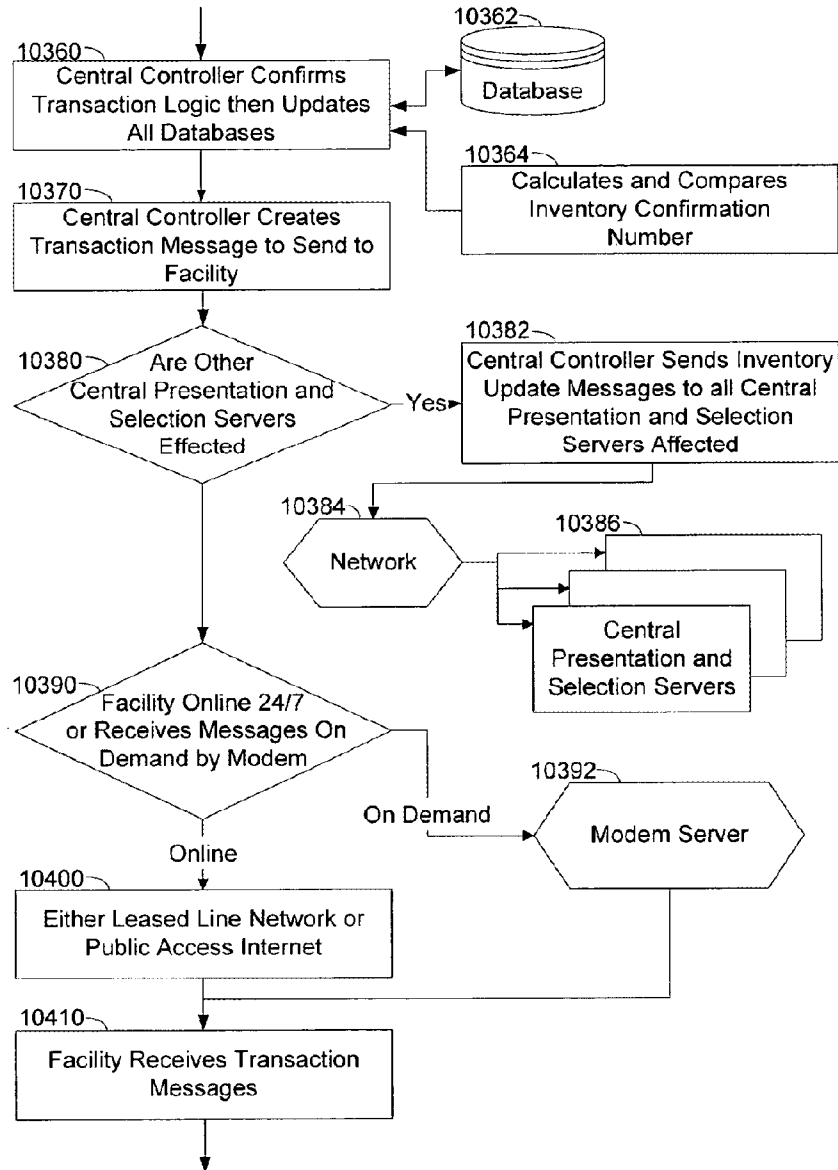

Fig. 3g

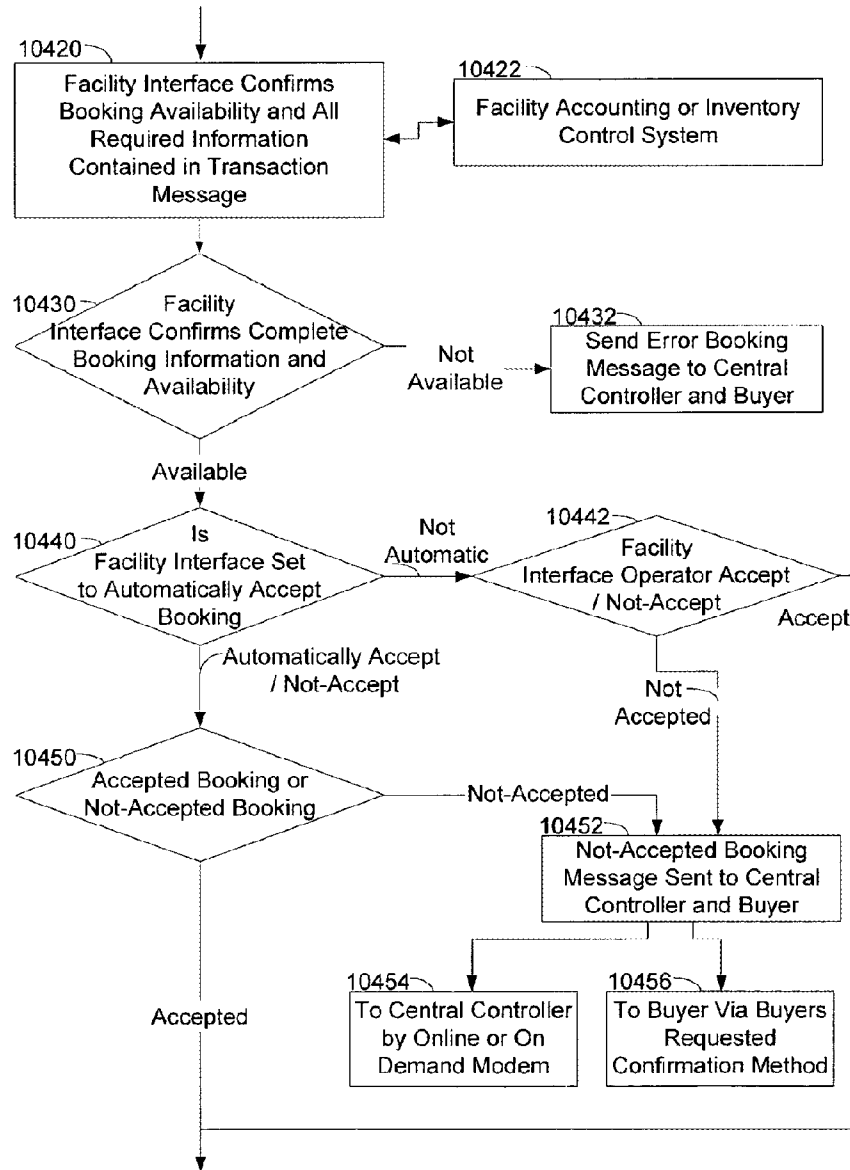



Fig. 3h

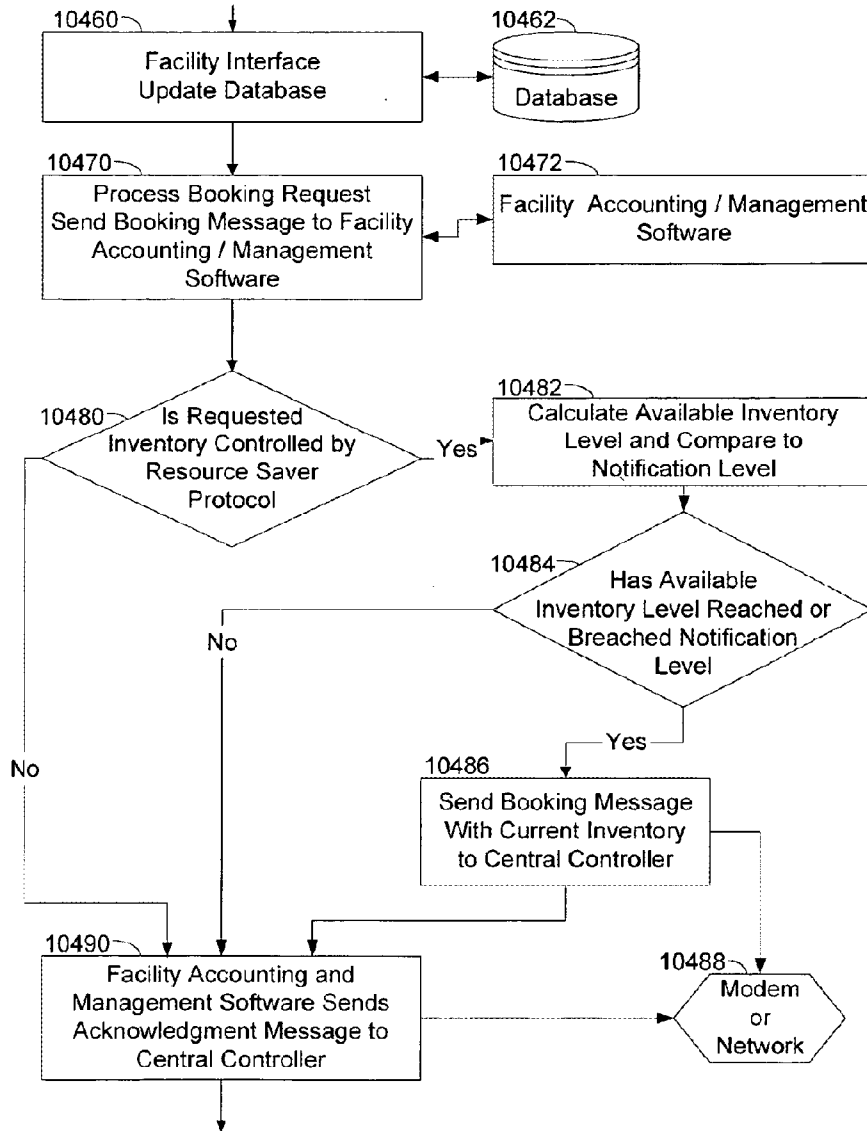

Fig. 3i

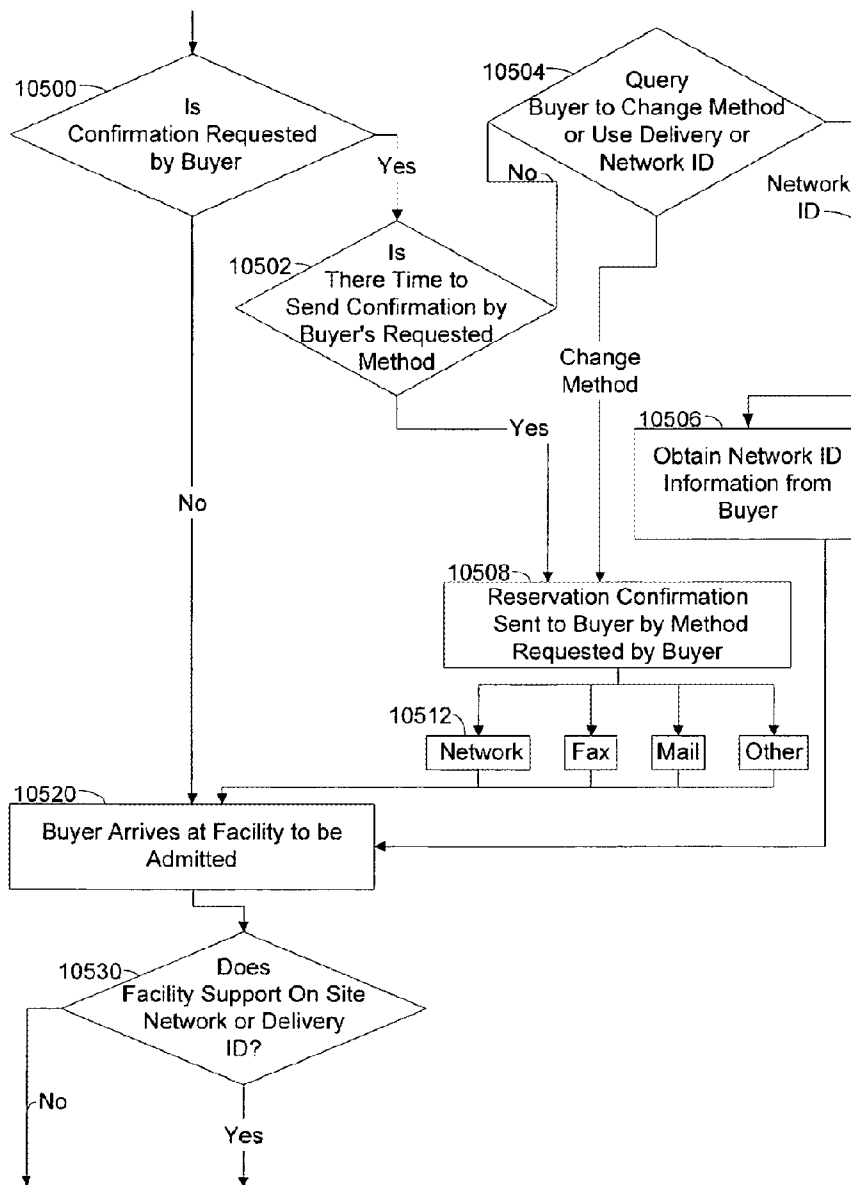

Fig. 3i-a

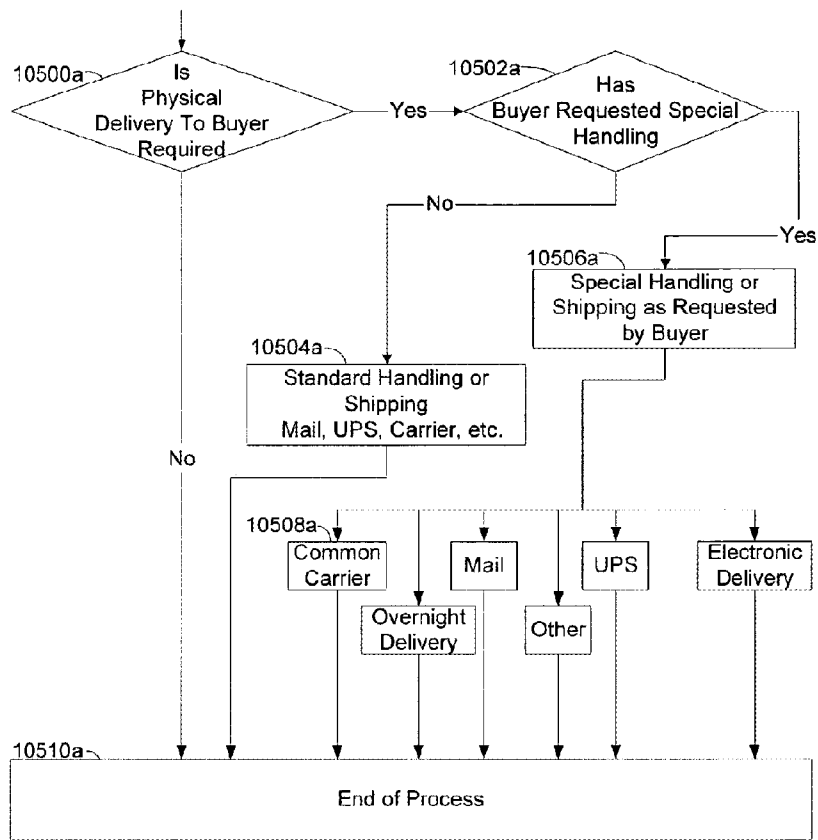

Fig. 3j

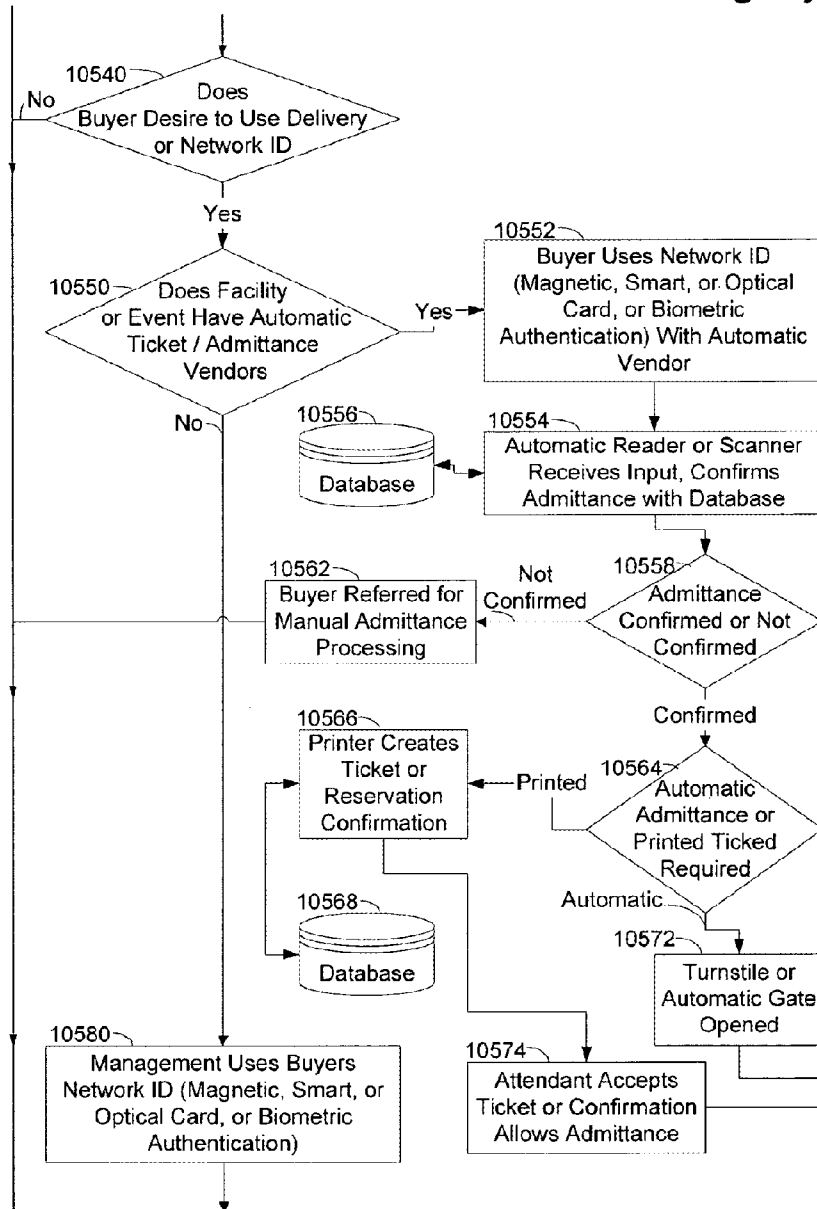

Fig. 3k

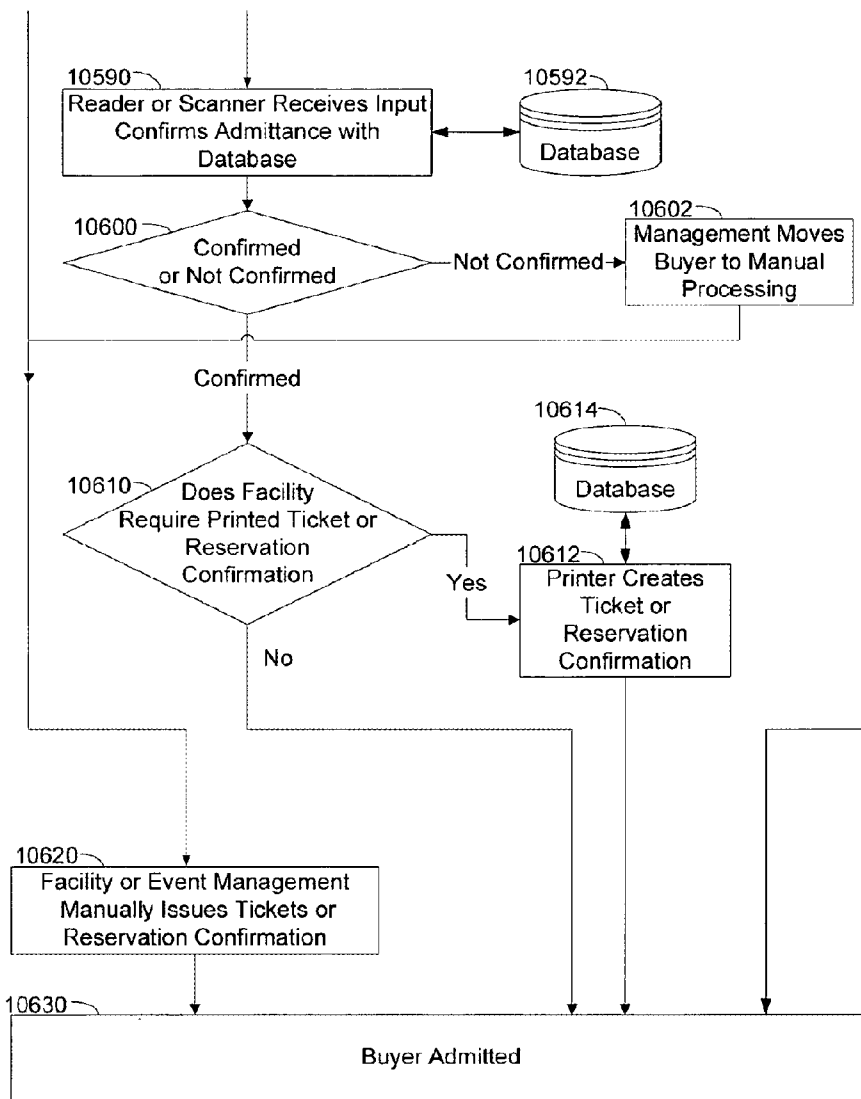

Fig. 4a

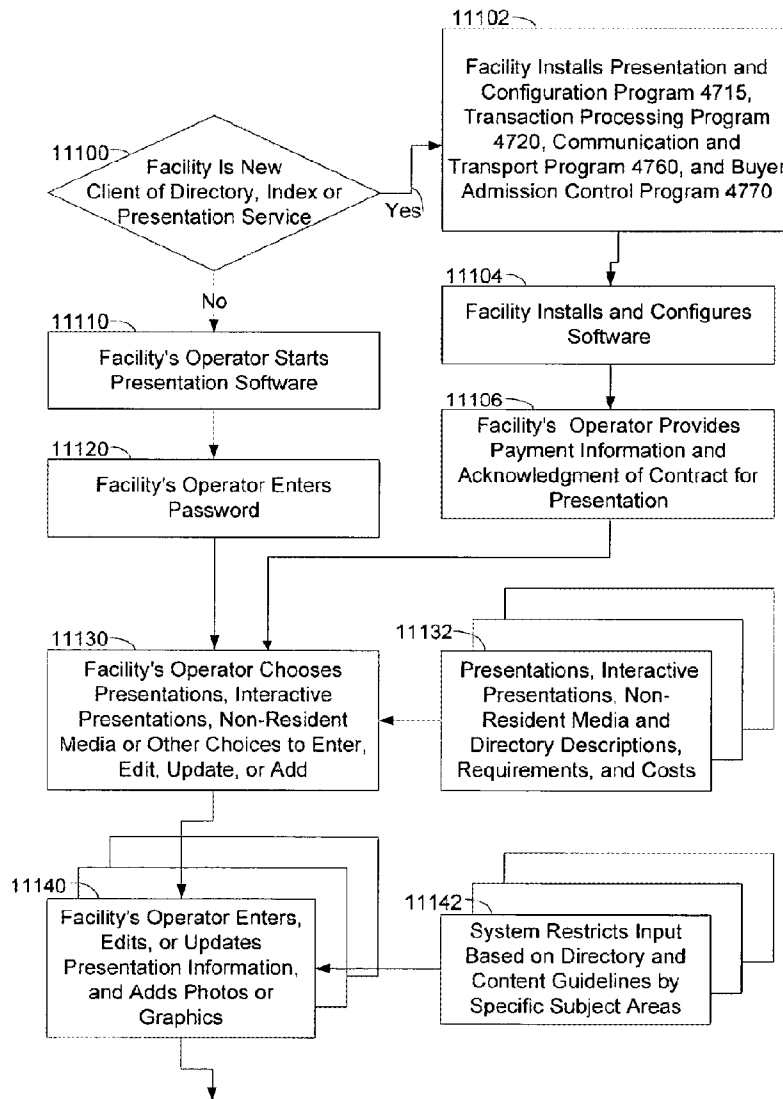

Fig. 4b

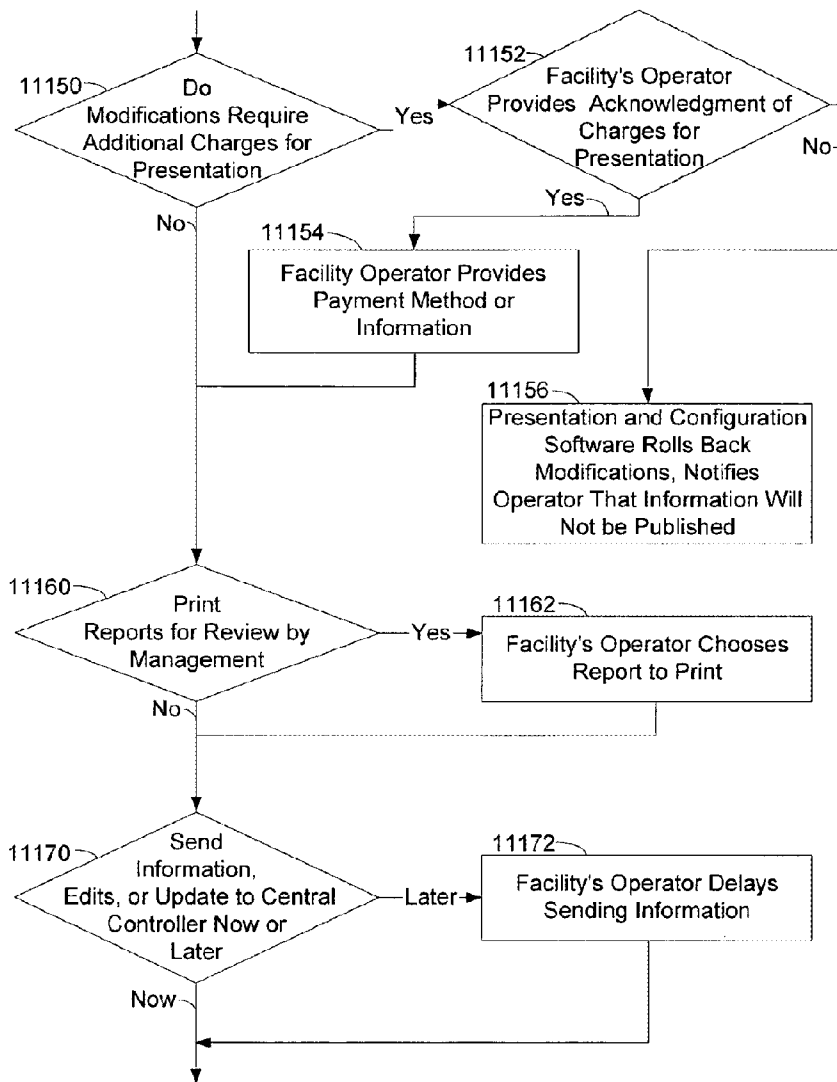

Fig. 4c

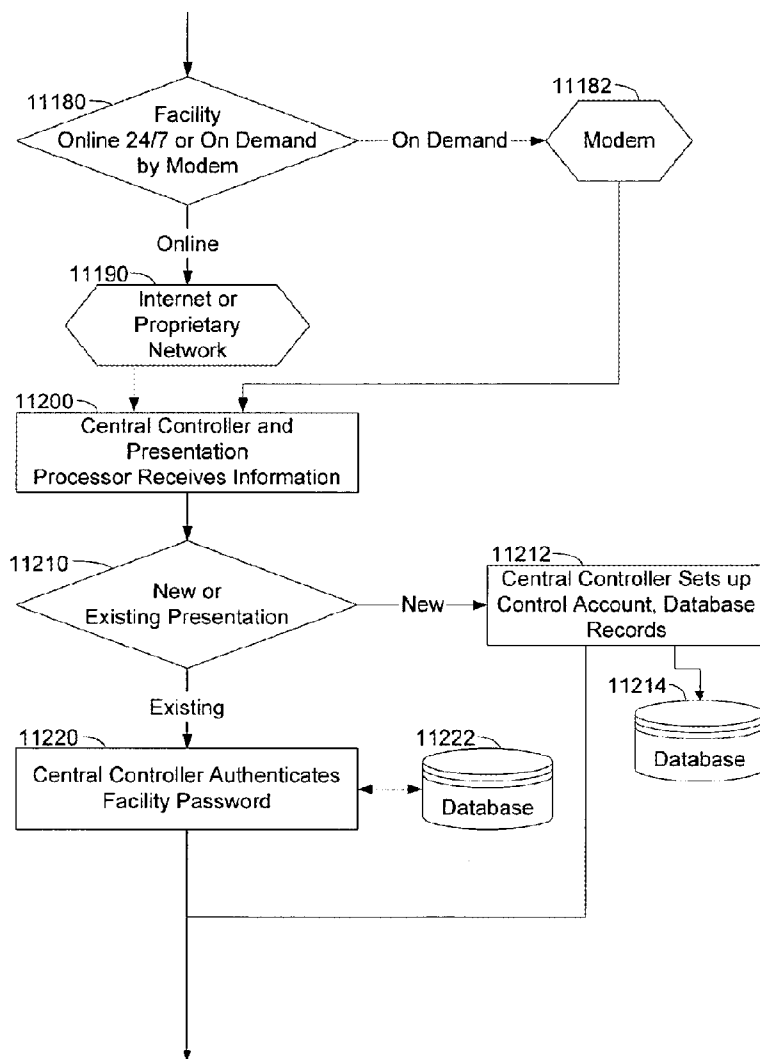



Fig. 4d

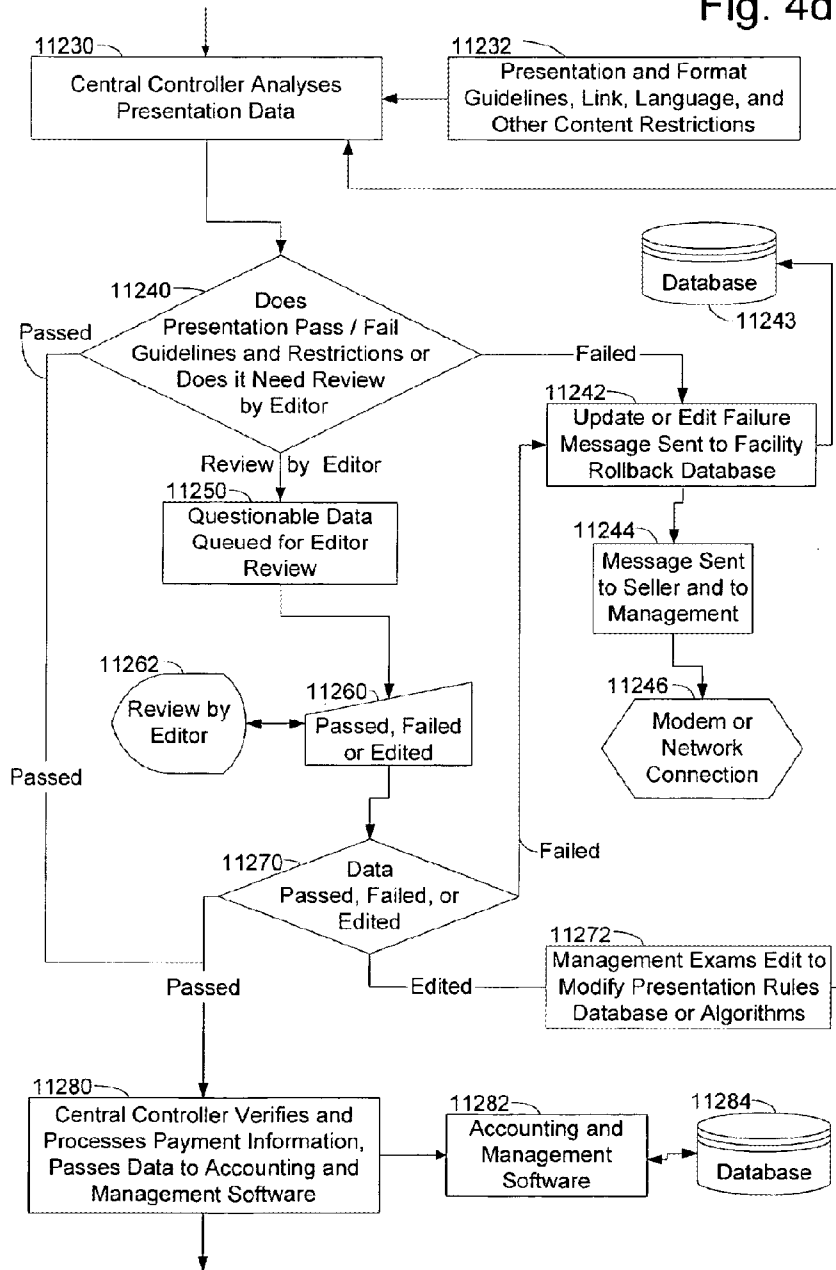

Fig. 4e

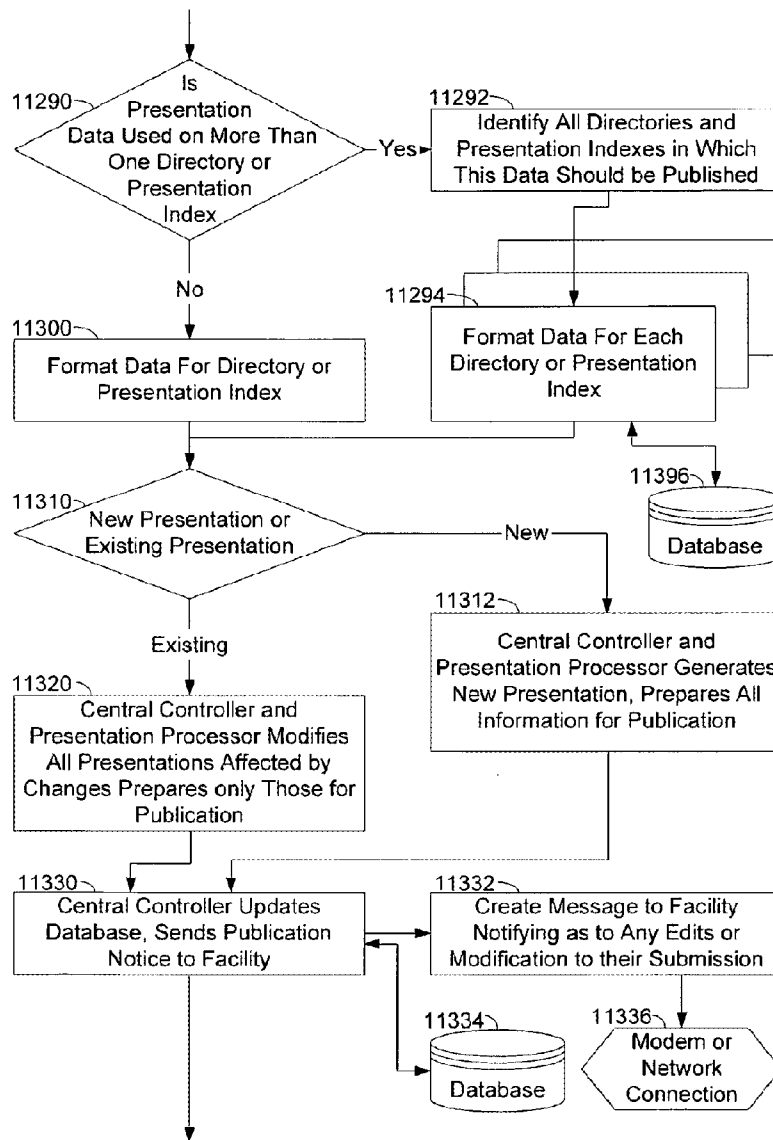

Fig. 4f

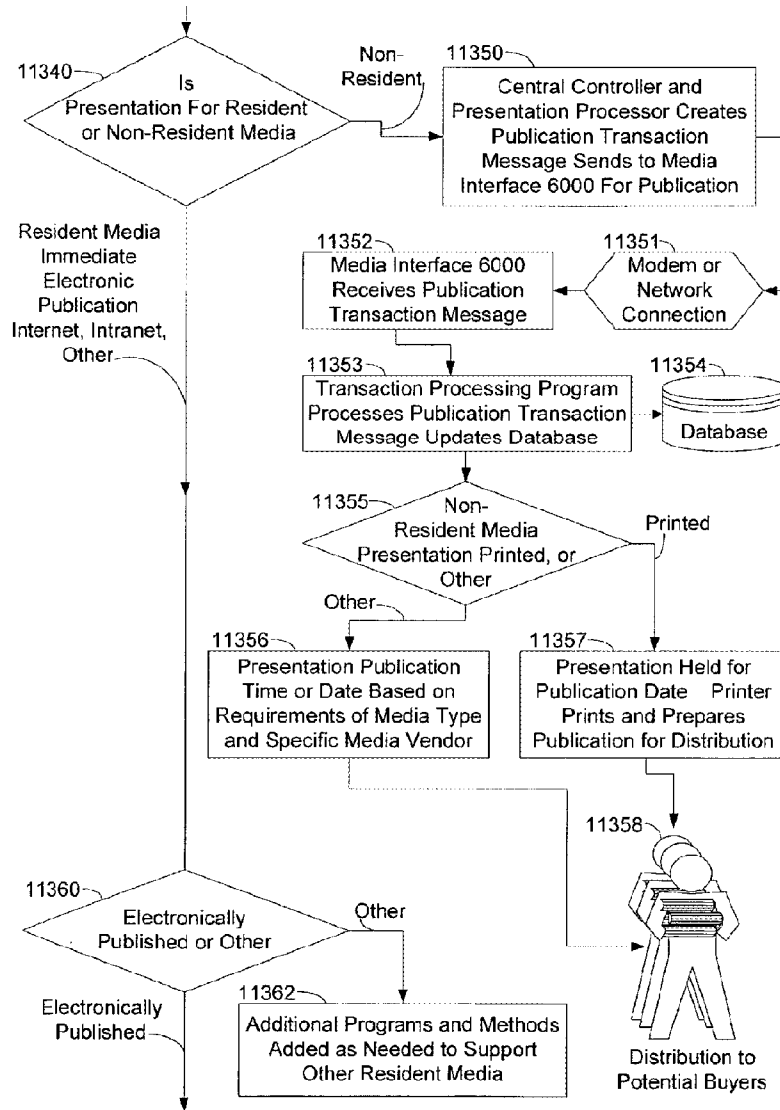

Fig. 4g

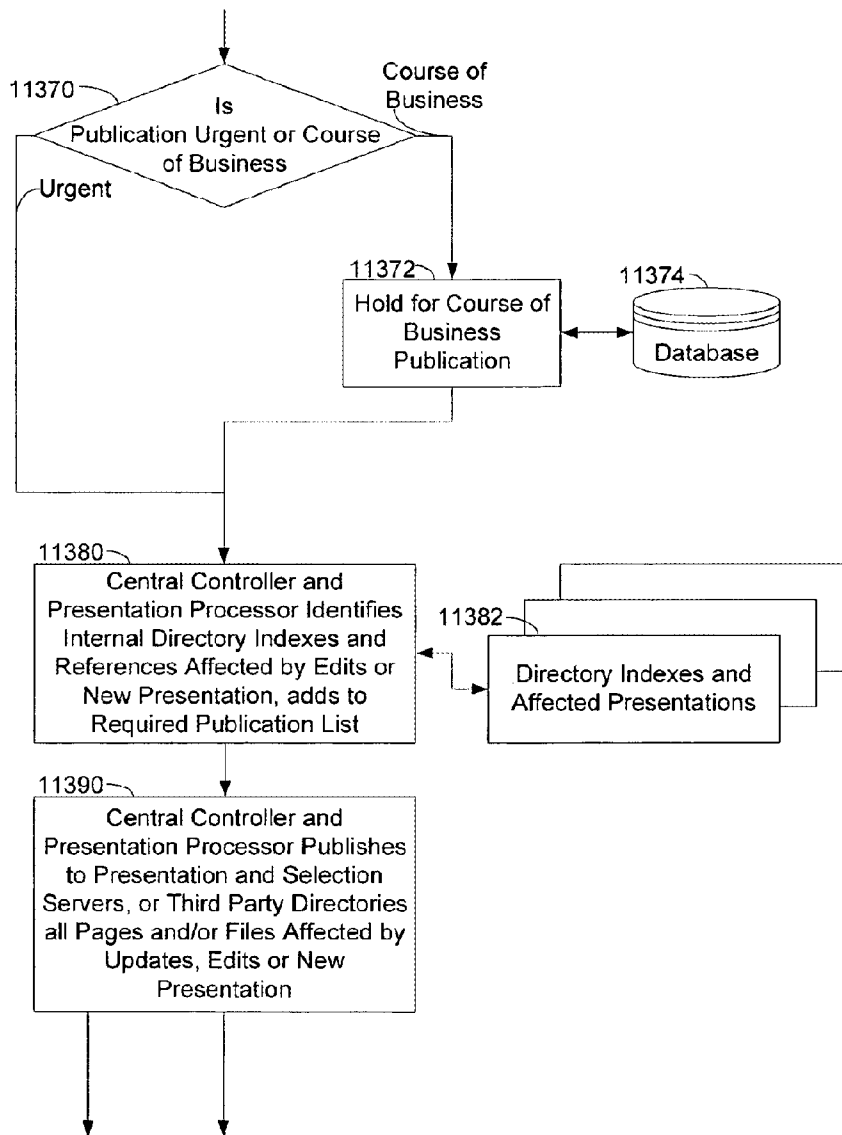

Fig. 4h

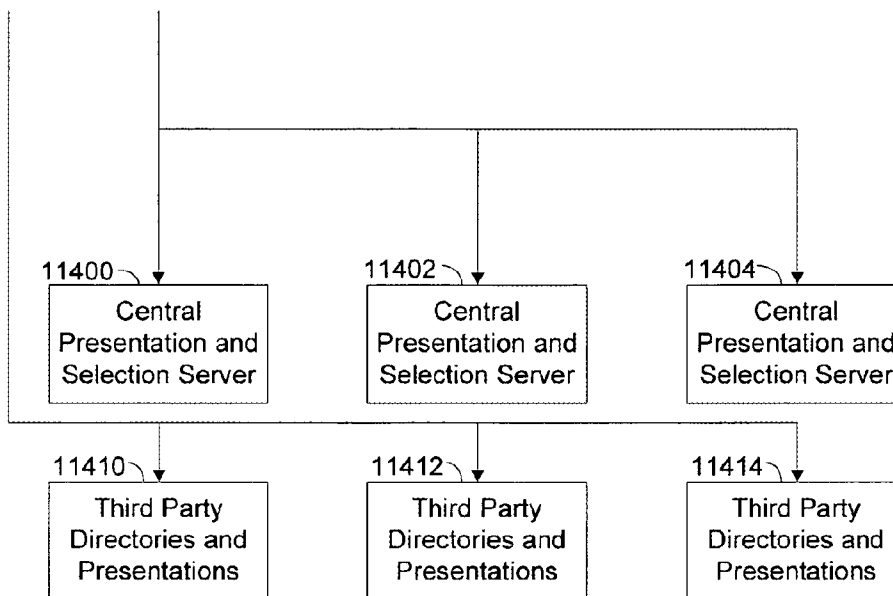

Fig. 5a

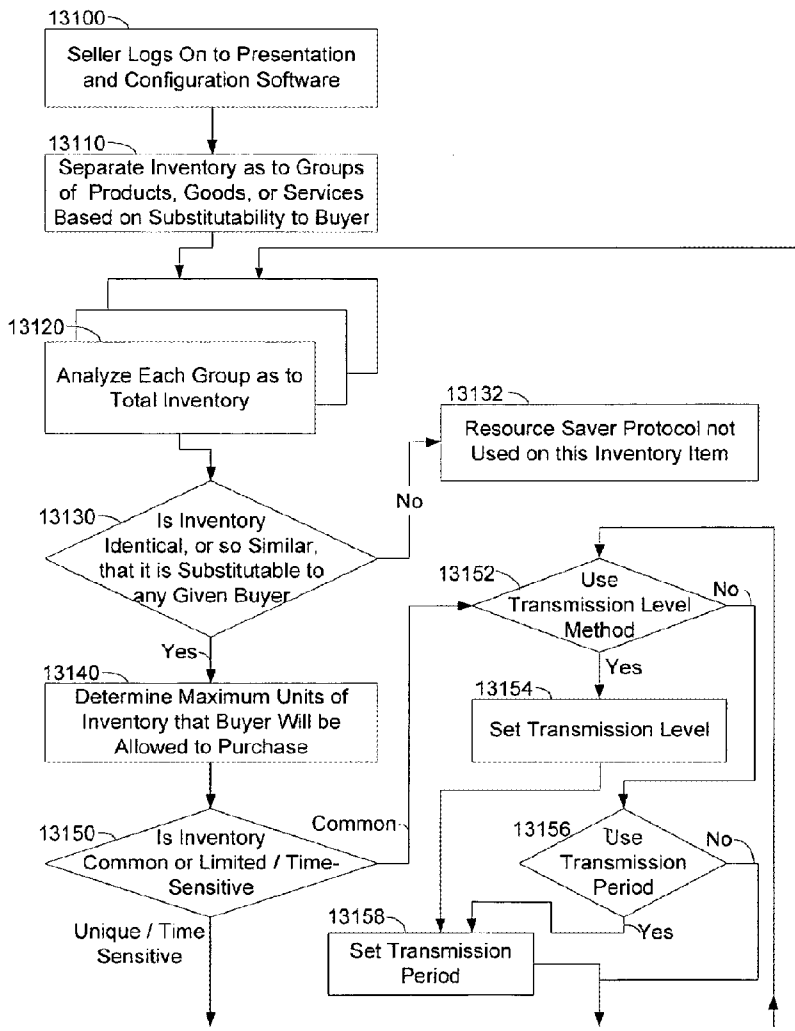

Fig. 5b

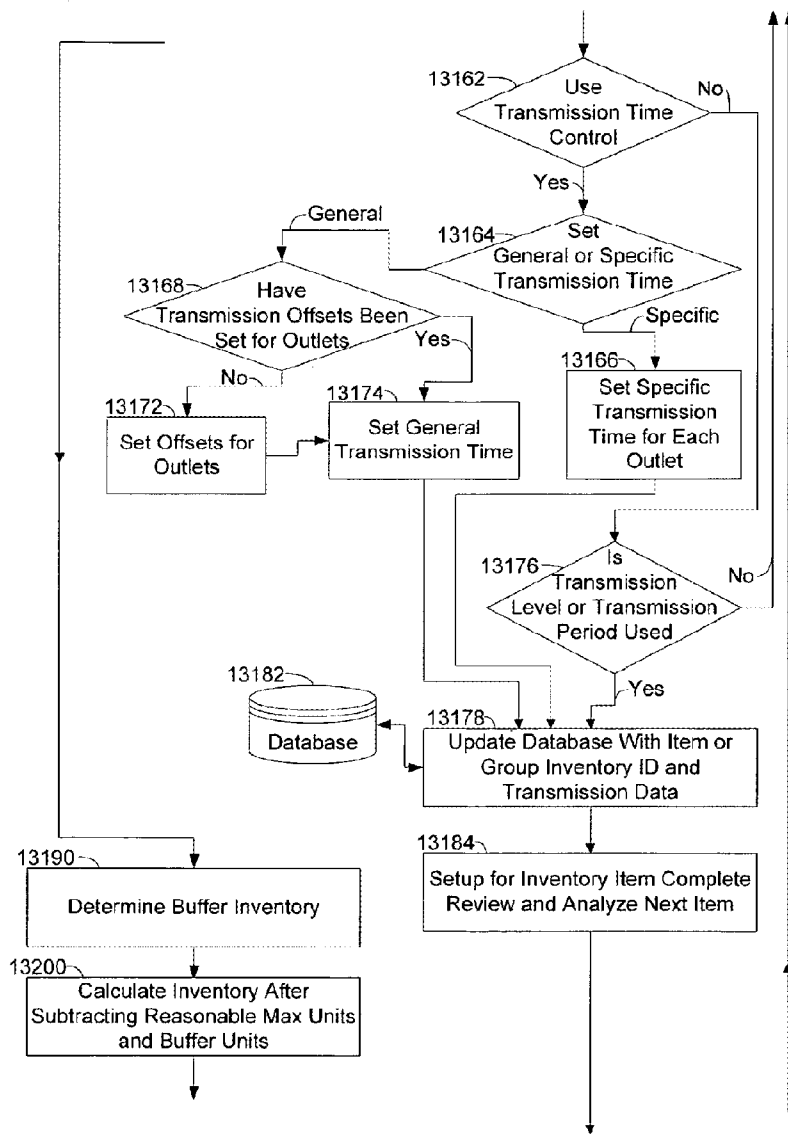

Fig. 5c

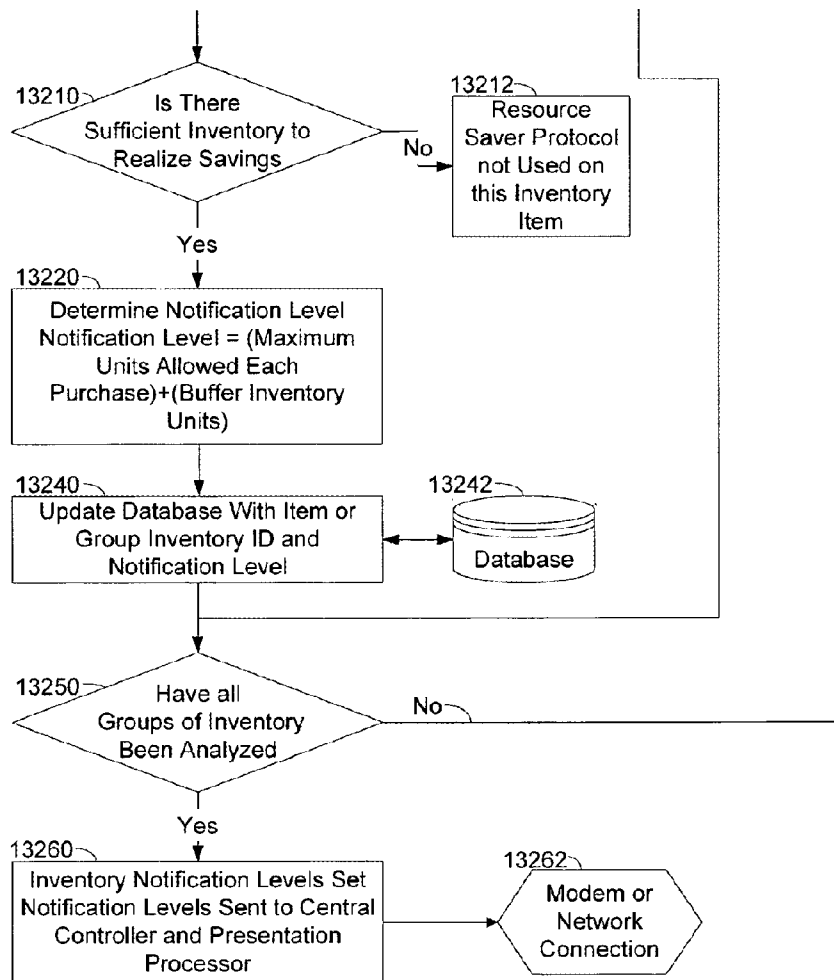



Fig. 5d

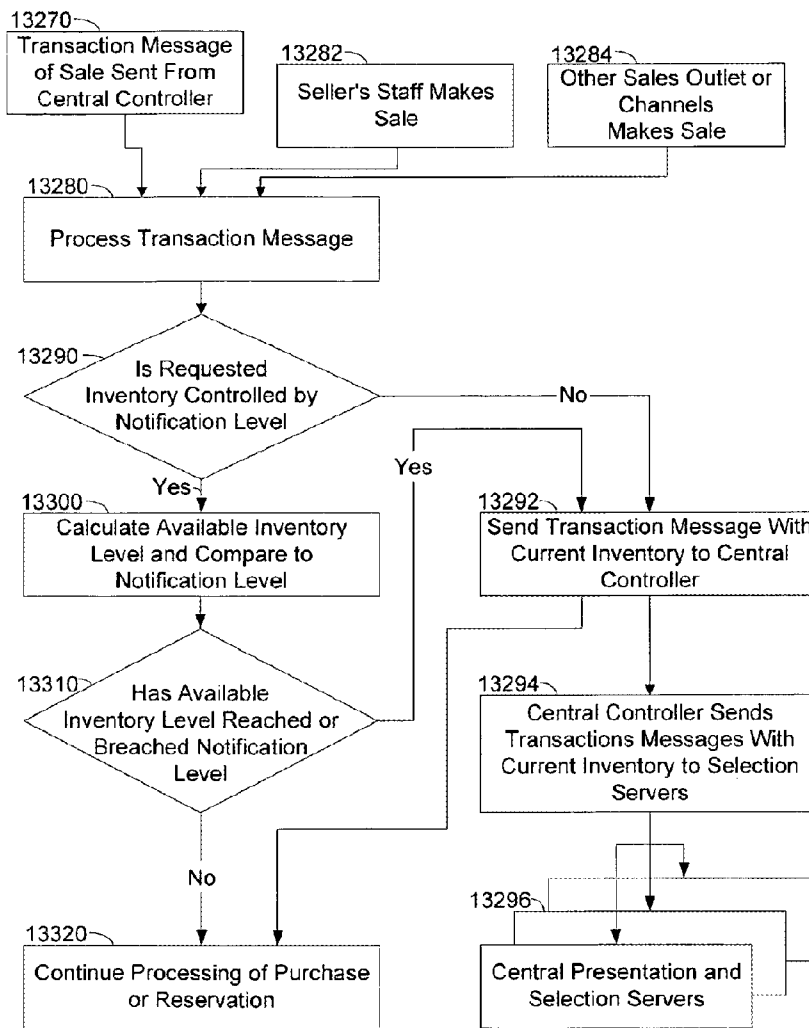

Fig. 5e

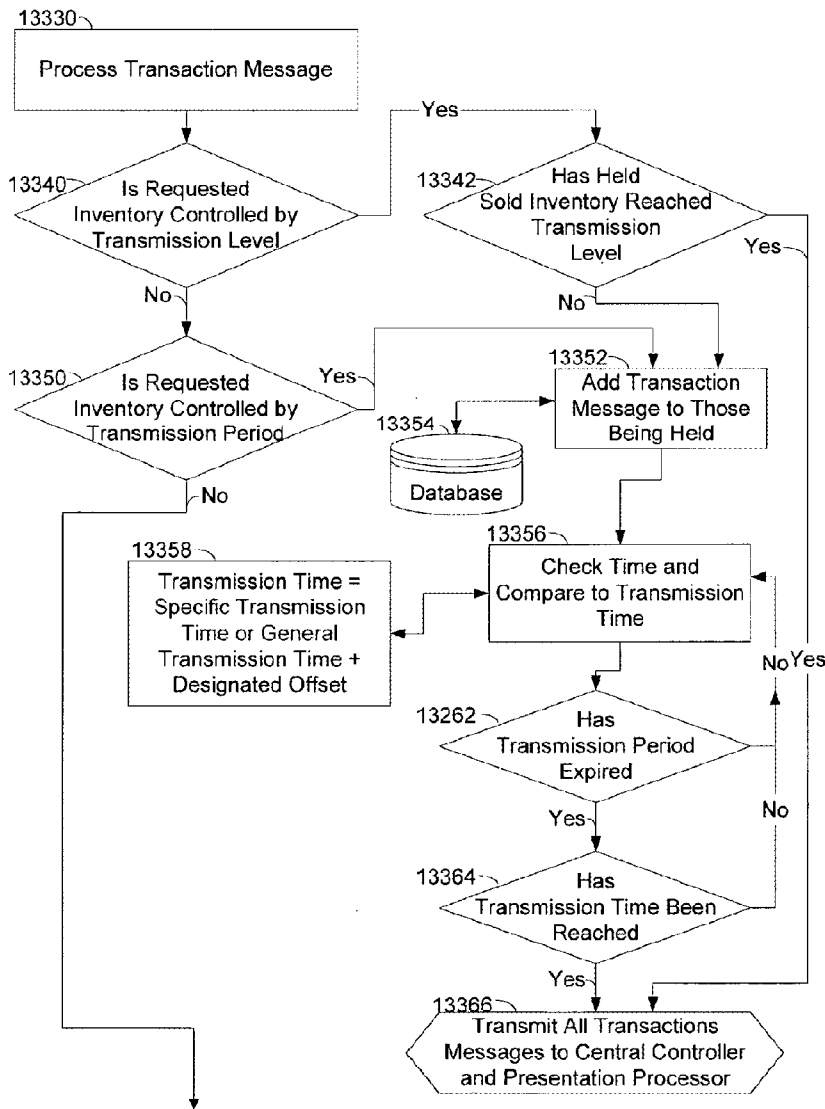

Fig. 5f

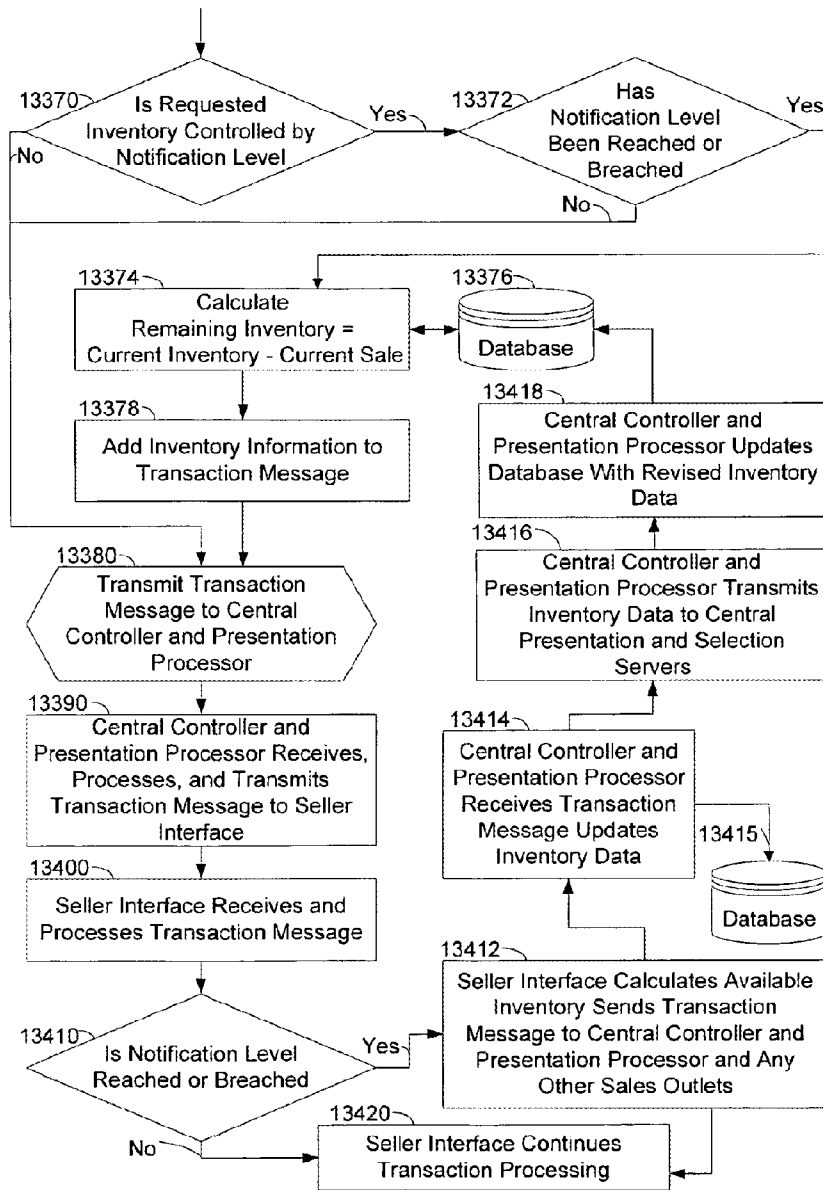

Fig. 5g

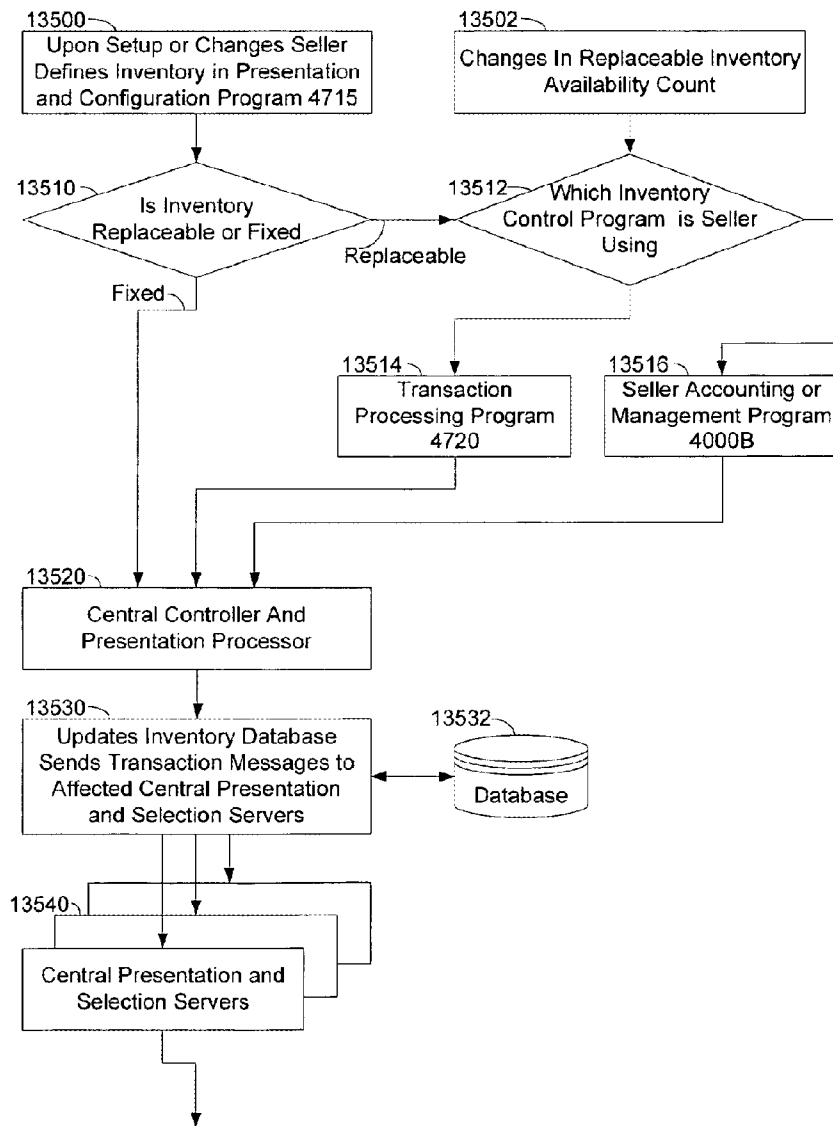

Fig. 5h

