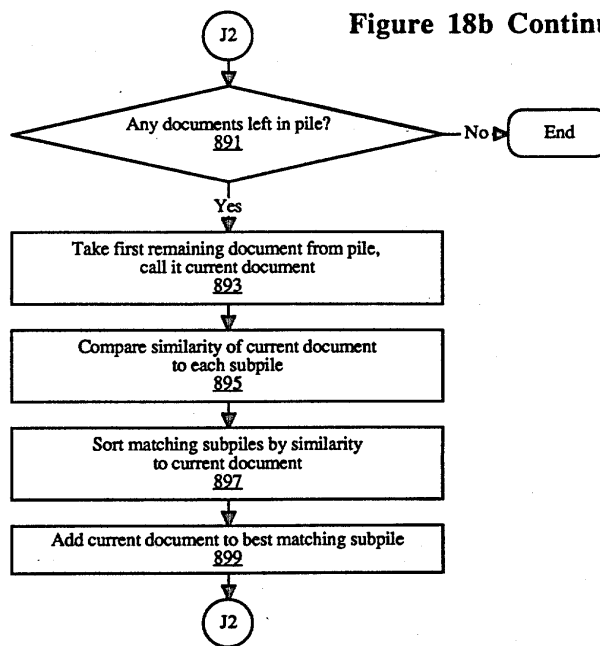

Figure 18b Continued



09756622 022704

Figure 20

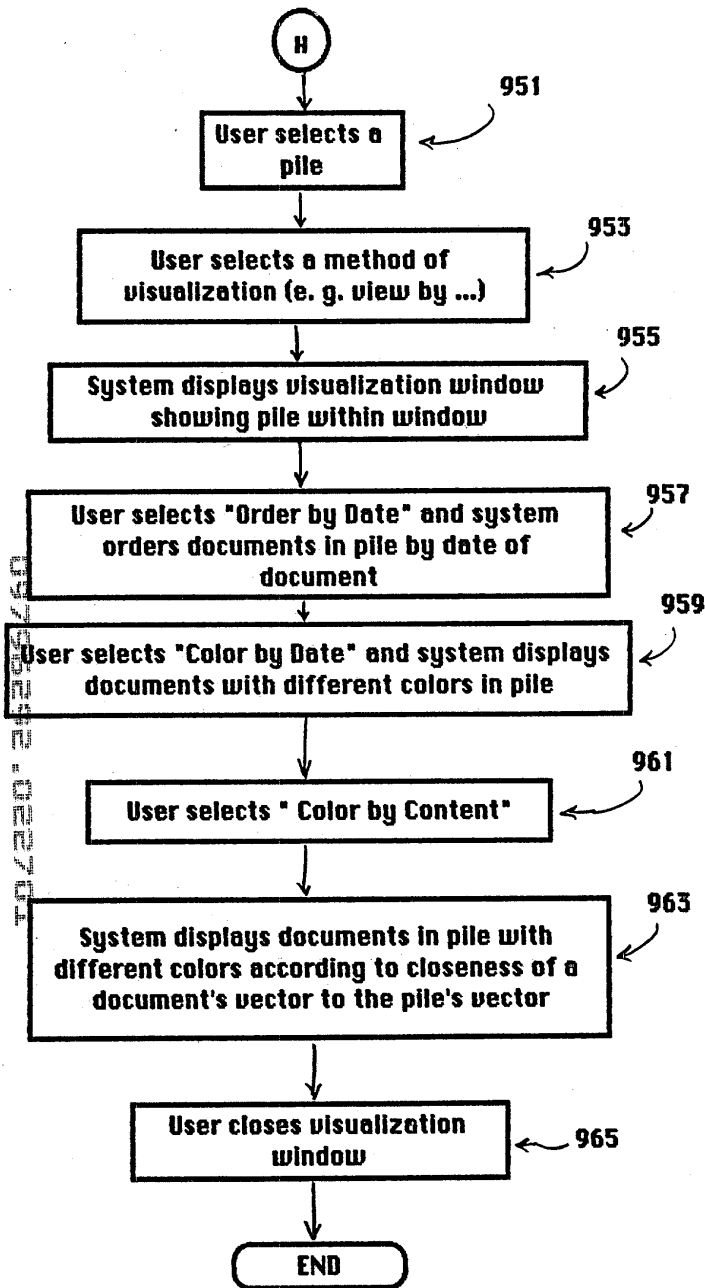

Figure 21

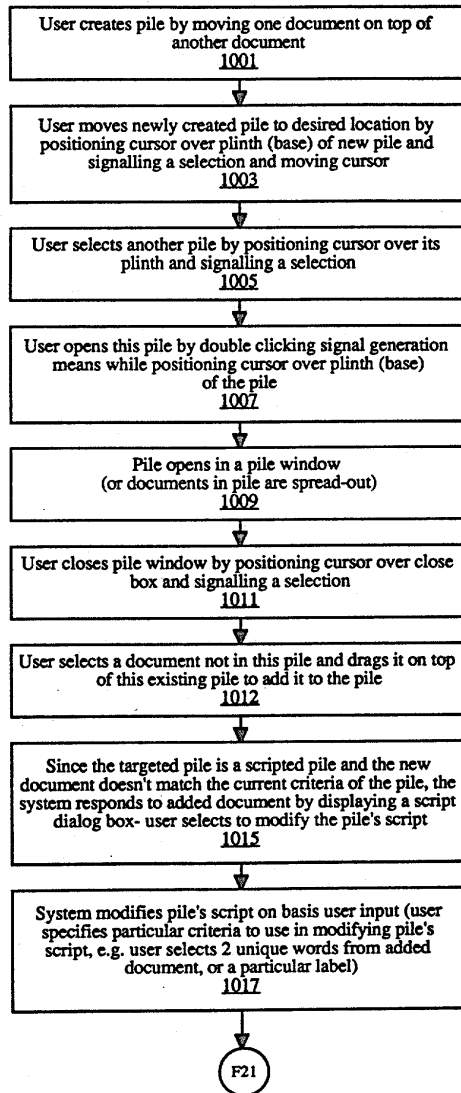
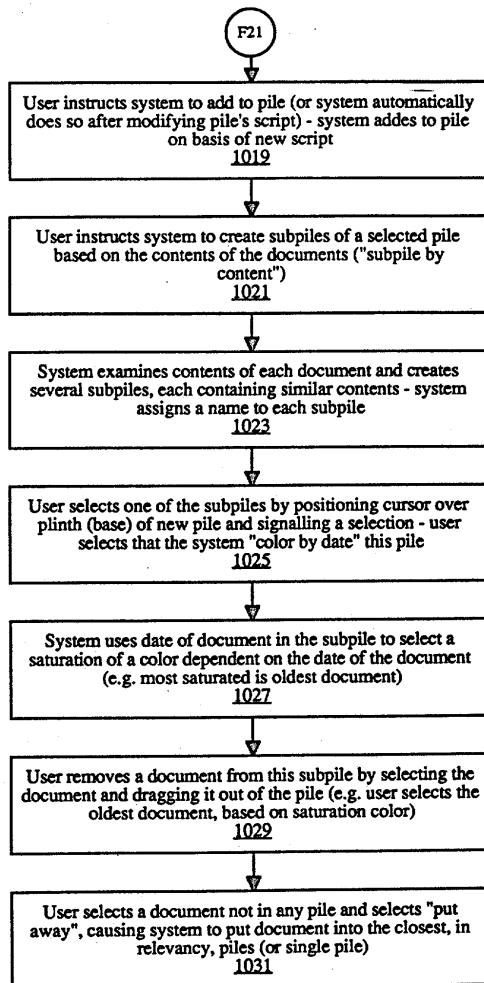

Figure 21 continued



09756222-02701

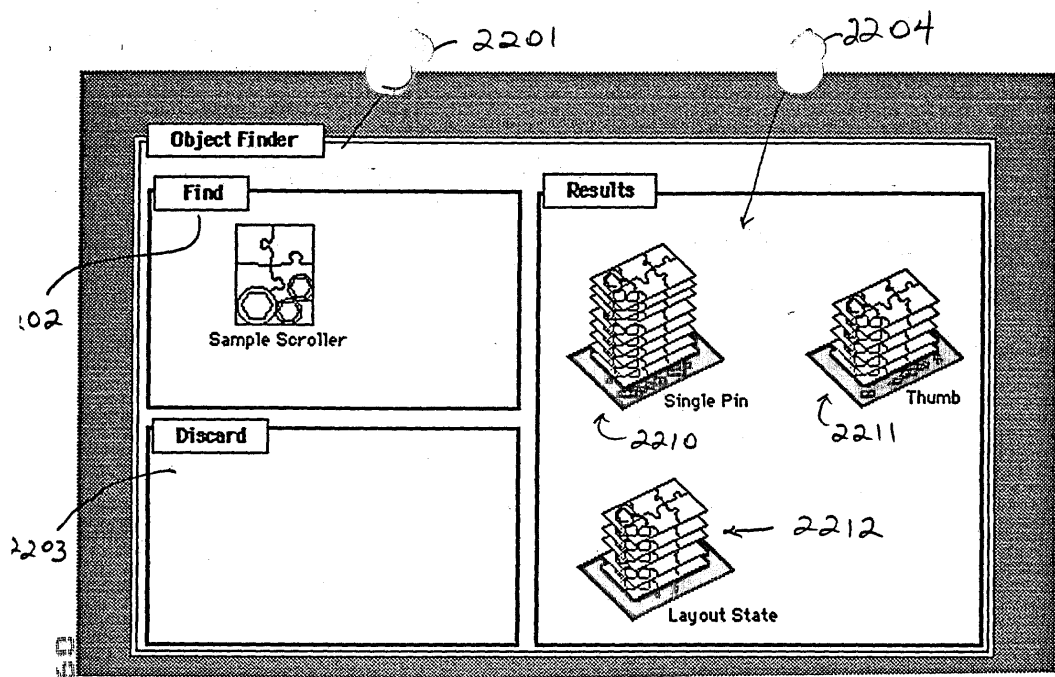

Figure 22a

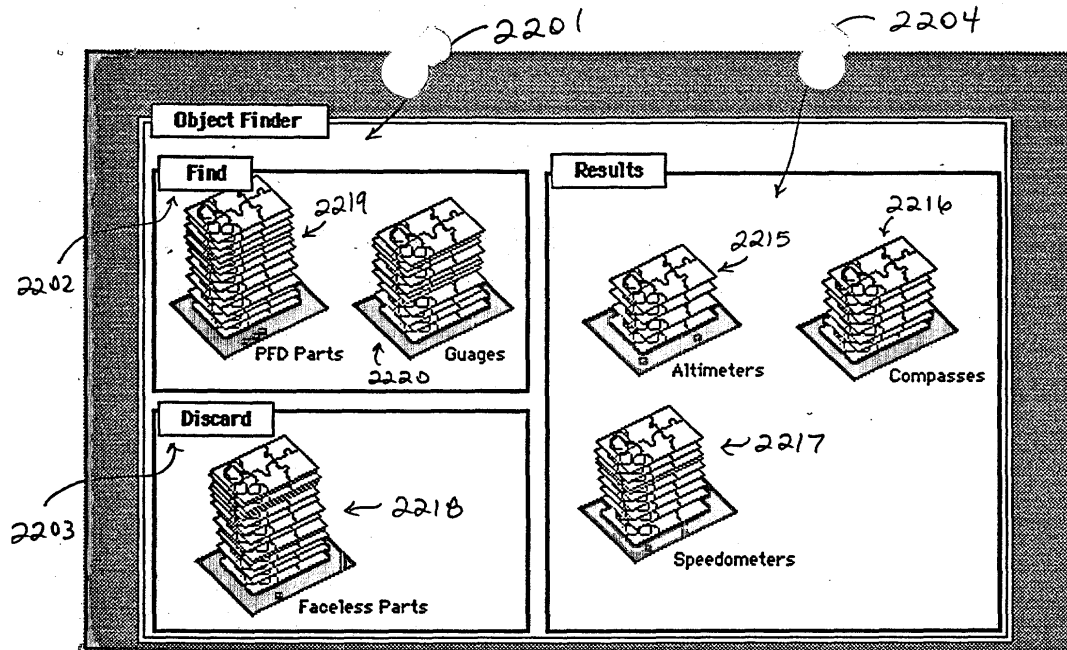

Figure 22b

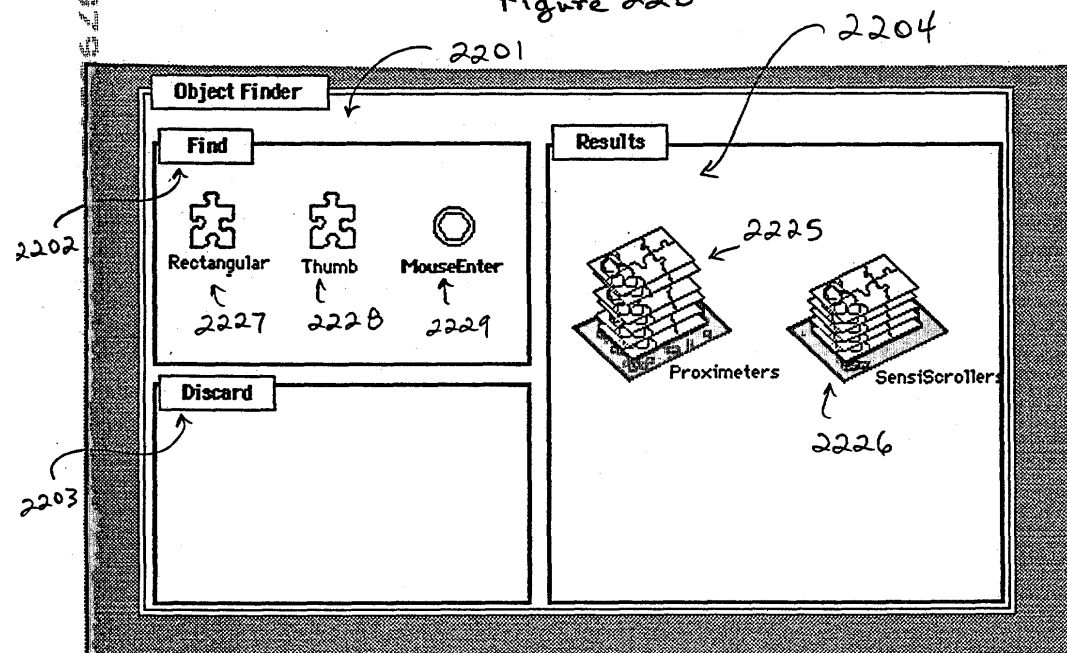

Figure 22c

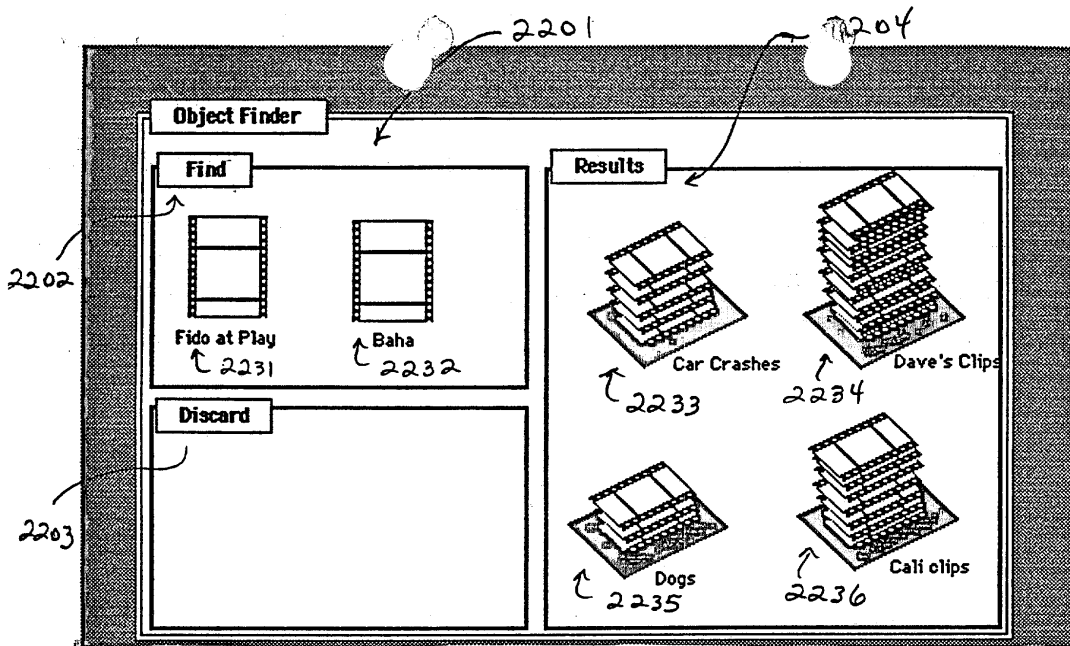

Figure 22d

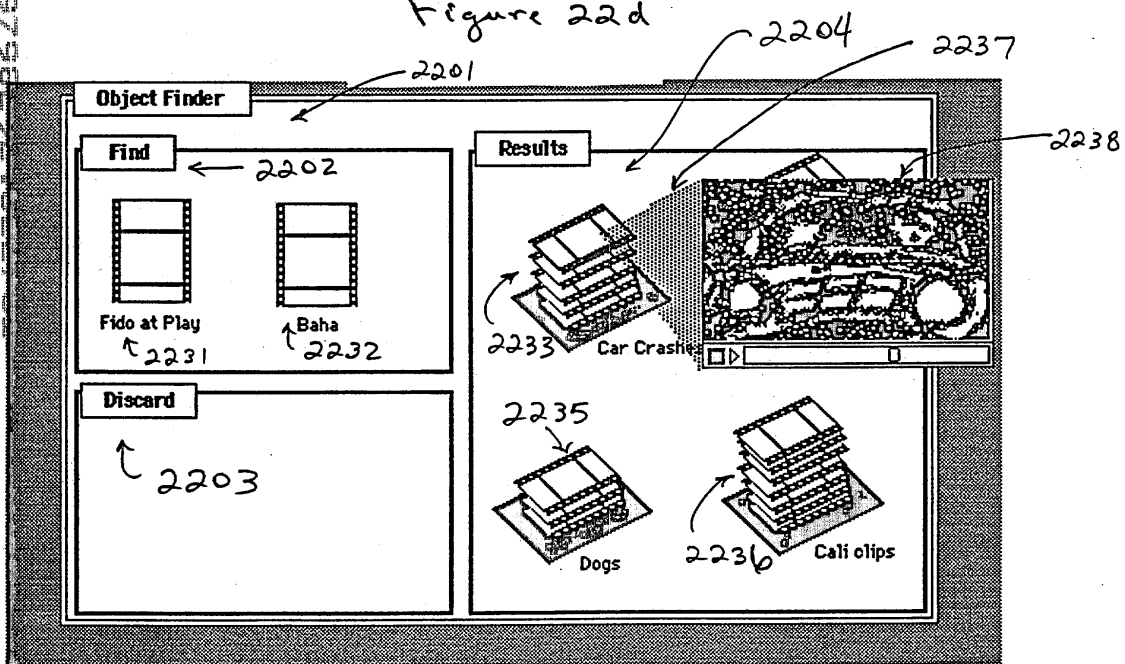
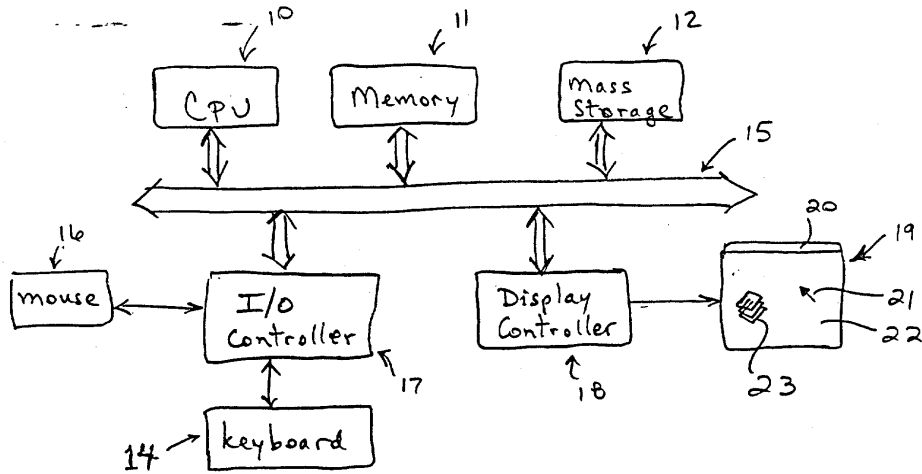

Figure 22e

Figure 1



12 SHEETS 5 SQUARE
13 SHEETS 3 SQUARE
14 SHEETS 3 SQUARE
15 SHEETS 3 SQUARE
16 SHEETS 3 SQUARE
17 SHEETS 3 SQUARE
18 SHEETS 3 SQUARE
19 SHEETS 3 SQUARE
20 SHEETS 3 SQUARE
21 SHEETS 3 SQUARE
22 SHEETS 3 SQUARE
23 SHEETS 3 SQUARE

101 FH 130
APMW0025974

PRINT OF DRAWINGS
AS ORIGINALLY F

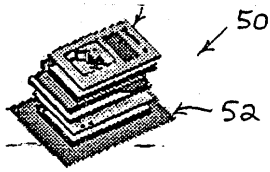

Fig. 2a

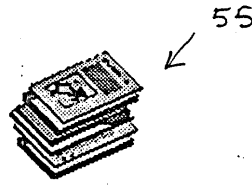

Fig. 2b



Fig. 2c

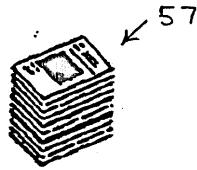

Fig. 2d

09796292.022701

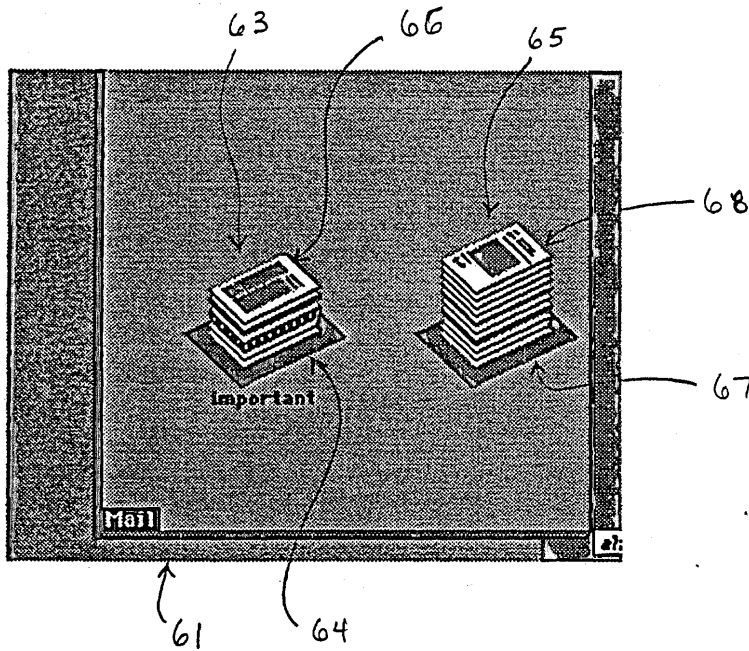
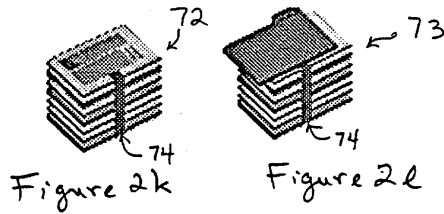
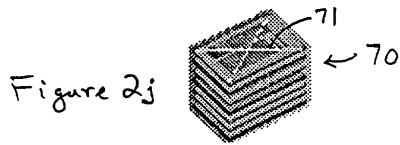
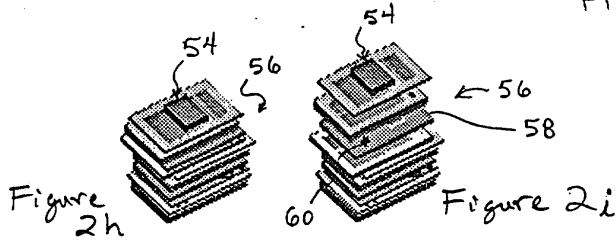
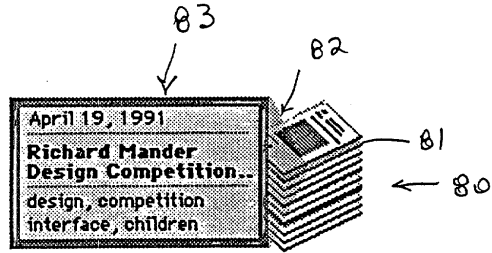
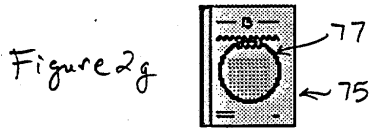
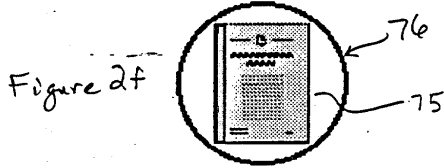

Figure 2e

PRINT OF DRAWINGS
AS ORIGINALLY FI



095622 022701

PRINT OF DRAWINGS
AS ORIGINALLY FILED

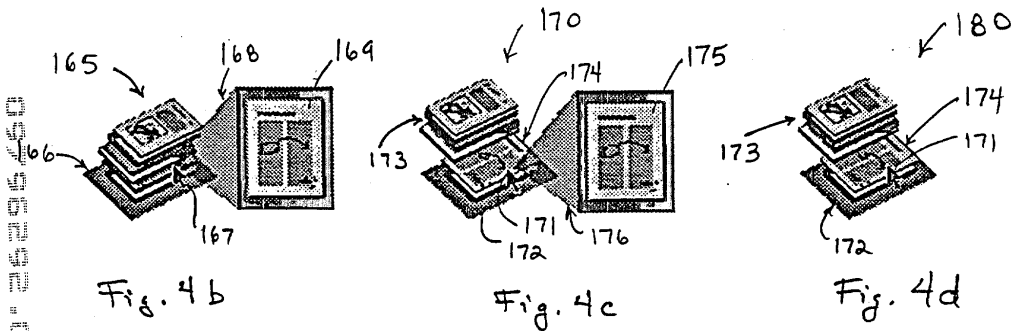
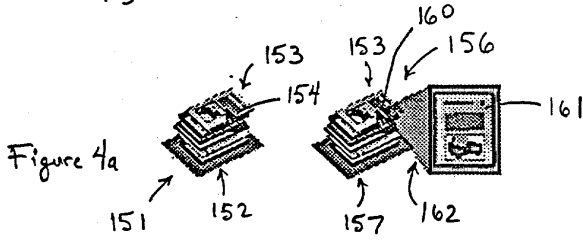
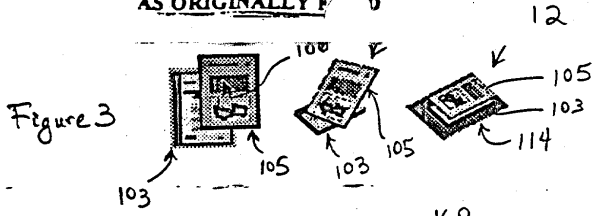

05/962932/000001

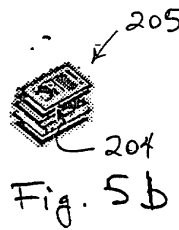
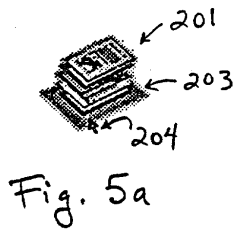
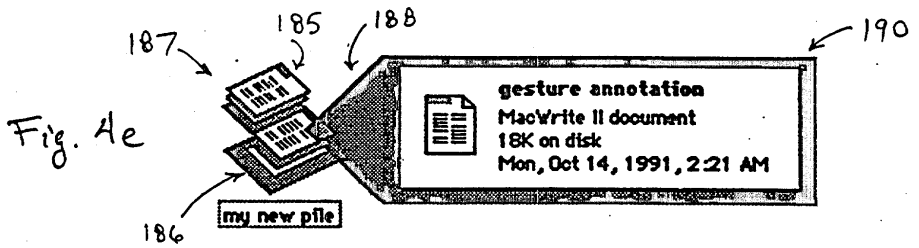

102220 26296760

126

Pg 7/10

It occurs to me that it would be a worthwhile exercise to crystallize our vision of One way to do this is to put together a video script (whether or not any video is ever made).

What are the (two or three?) important ideas? Why will a be more interesting than anything else that will be around in a couple of years? What are the illustrative uses for. why is

Find: Blackstone

Who is the audience for **start** forming the video is for us, to clarify what is important and interesting in the actual video, if any, could be for internal advertising (i.e., for other groups that we hope will do things for us and with us and for executive staff to keep resources coming); it could also be for external consumption to create demand for and interest in the kind of stuff we're doing.

What do I want from you? Anything you have on the questions above.

125

Figure 4g

127

10/22/80 25295/50

128

129

pg 7/10

The Market

For images by 7/10

Blackstone approach to the project has a number of difficult challenges to overcome in the next phase of development. To help understand exactly what these challenges are, we need to first review the intended market and how that might influence industrial design.

Image: image with a strong sense of style forgoing the complete friendly style. unique physical appearance to the look and feel of its software. Blackstone should be the next icon of this of?

Find: Blackstone

company with reputation for approachable, and from it's annual report

Uniqueness for the marketplace: Industrial design is one of the most

129

Figure 4h

10220" 26295263

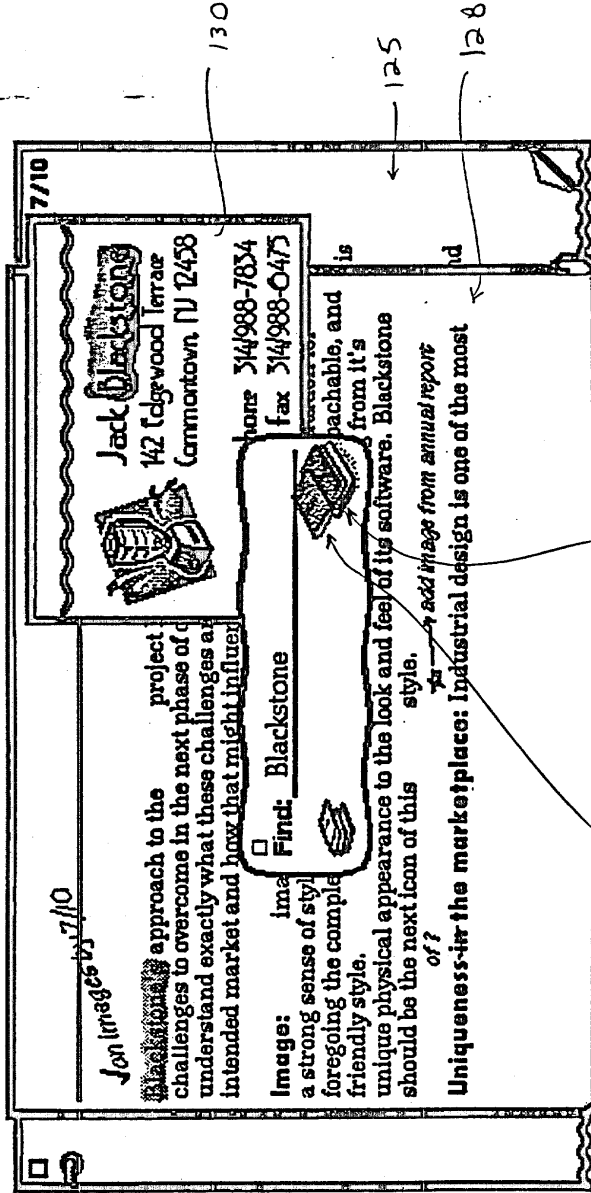
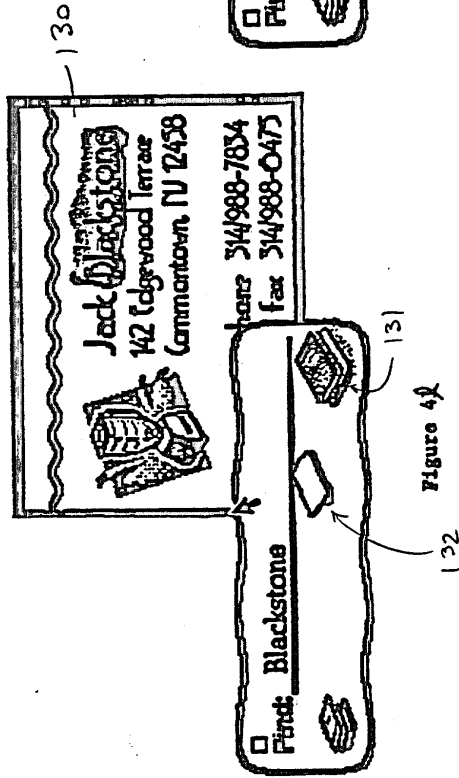
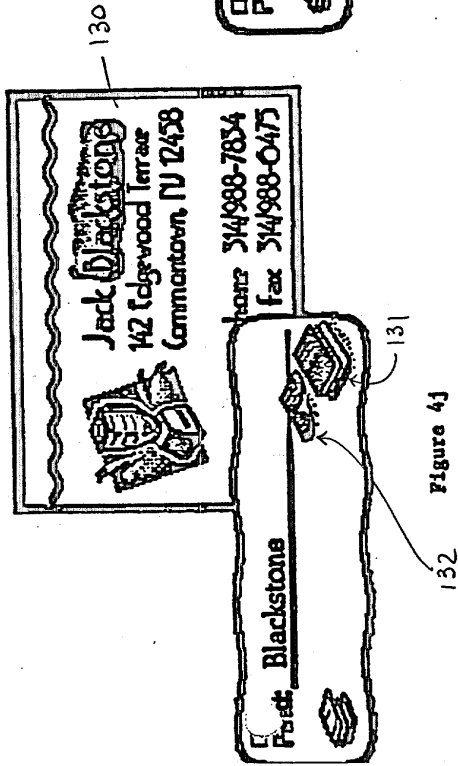
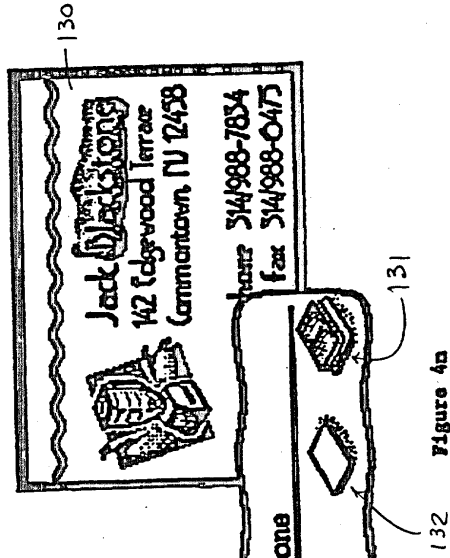
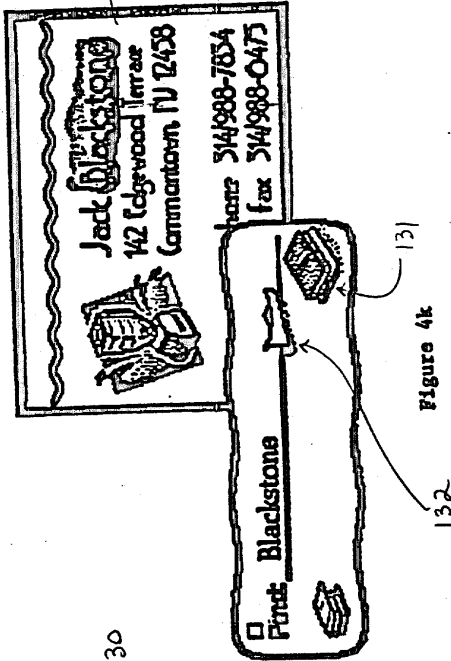

Figure 41

707220 25296760

PRINT OF DRAWINGS
AS ORIGINALLY



PRINT OF DRAWINGS
AS ORIGINALLY F

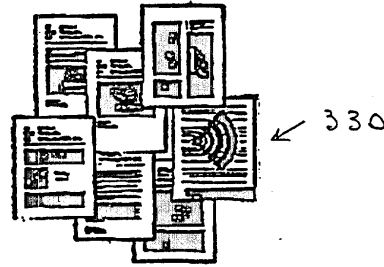
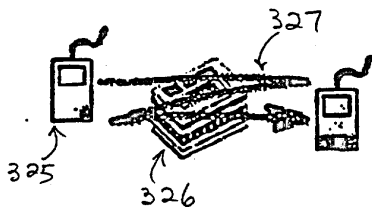
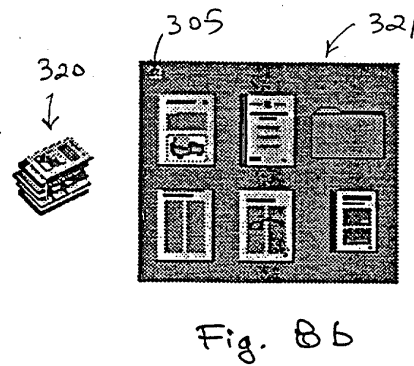
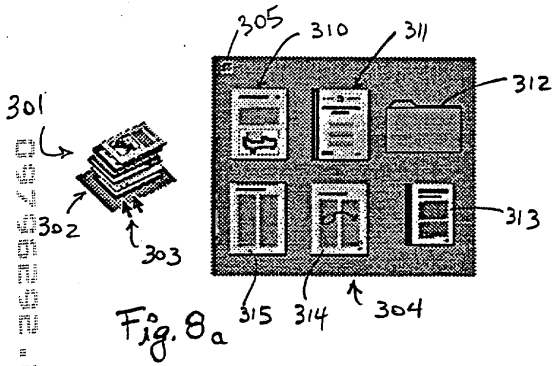
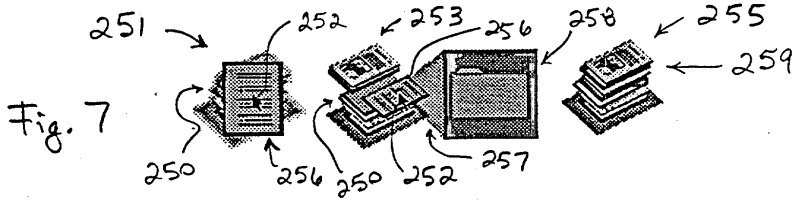
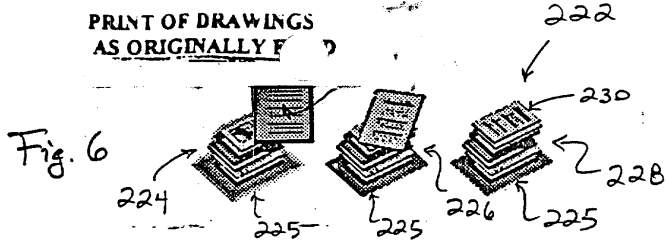

09706092-022701

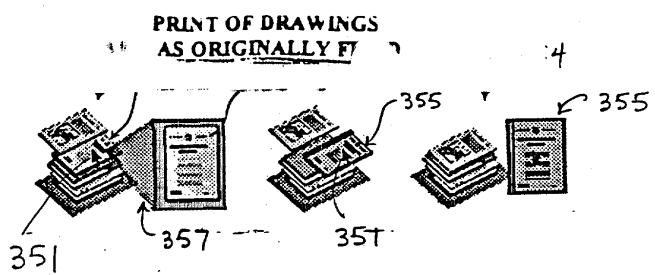

Fig. 9a

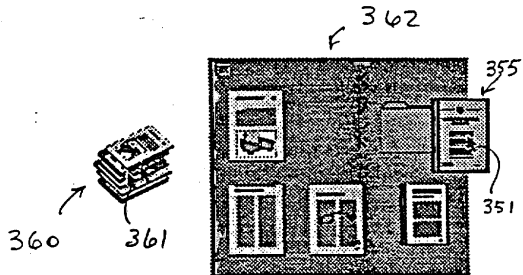

Fig. 9b

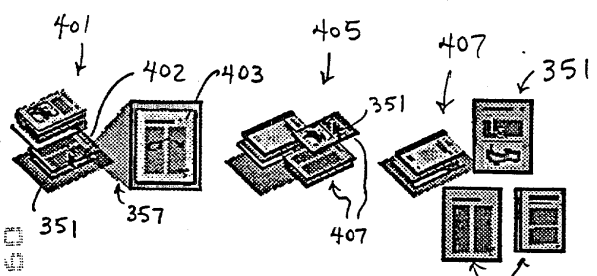

Fig. 10a

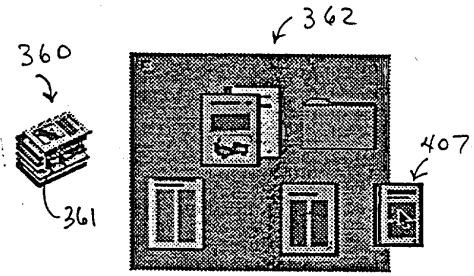

Fig. 10b

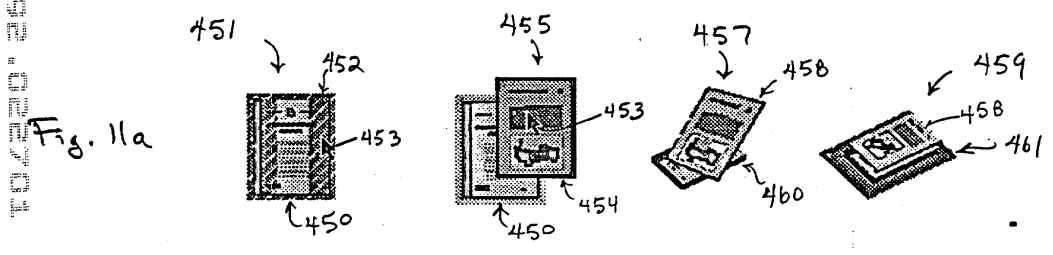

Fig. 11a

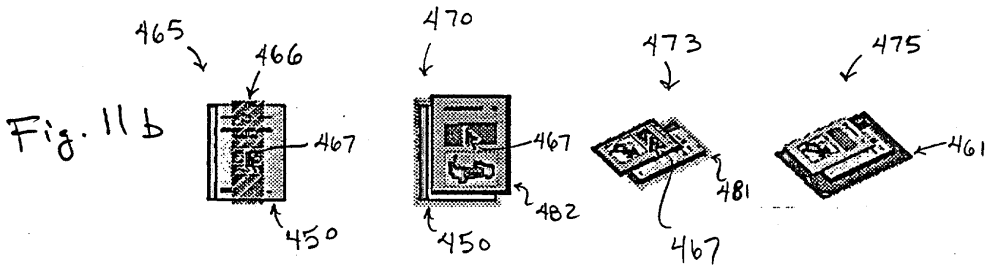
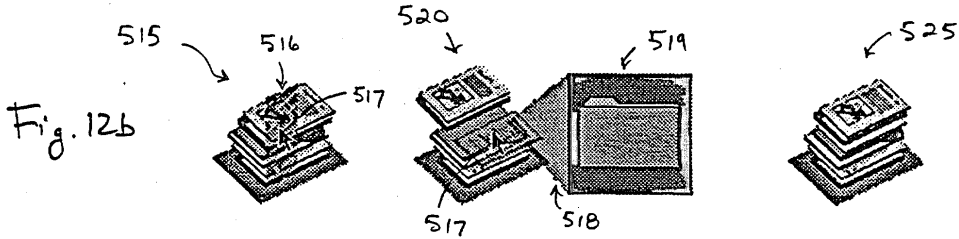
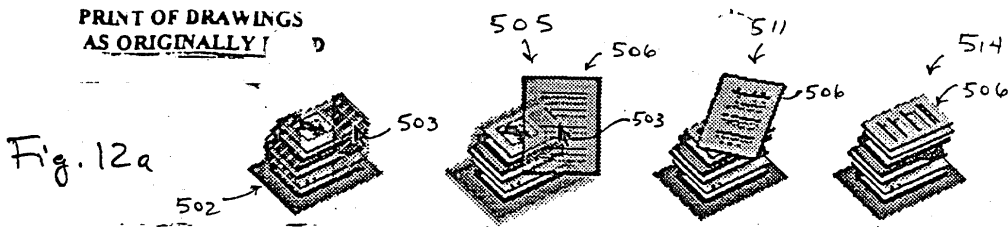

Fig. 11b

09786292.022701

PRINT OF DRAWINGS
AS ORIGINALLY



0070555102274

Fig. 13a

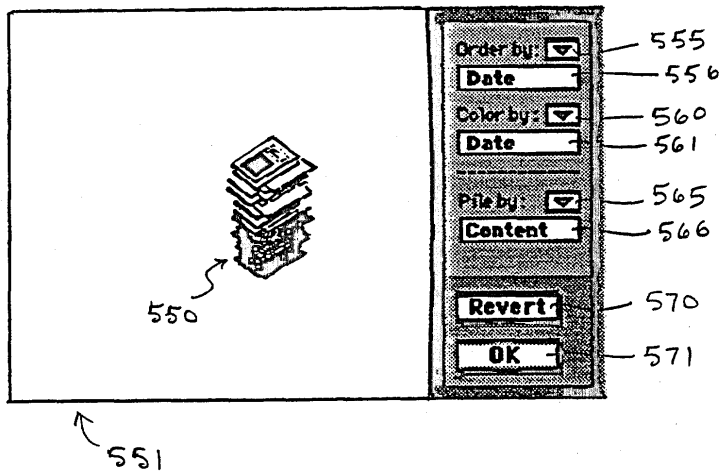

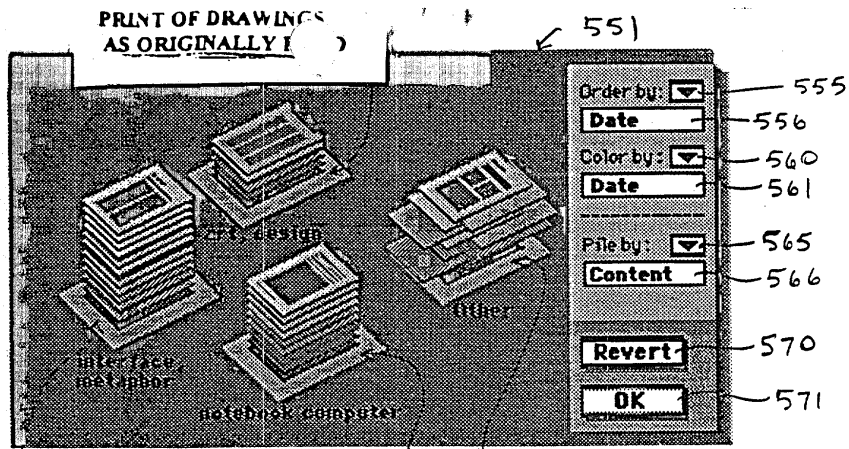

575 Figure 13 b

09796920-922704

PRINT OF DRAWINGS
AS ORIGINALLY F...D

601

603

Just add this item

Modify the pile's script

Collect items:

607 From: Richard Mander

608 Date: 4/19/91

609 Re: Design competition update

contain the words:

612

design
competition
interface
children
schools

611

627

629

628

contain the labels:

617

Design

614

630

615

623

625

620

621

Figure 14

10 SHEETS SQUARE
10 SHEETS SQUARE
10 SHEETS SQUARE



FOR "REPRODUCTION"

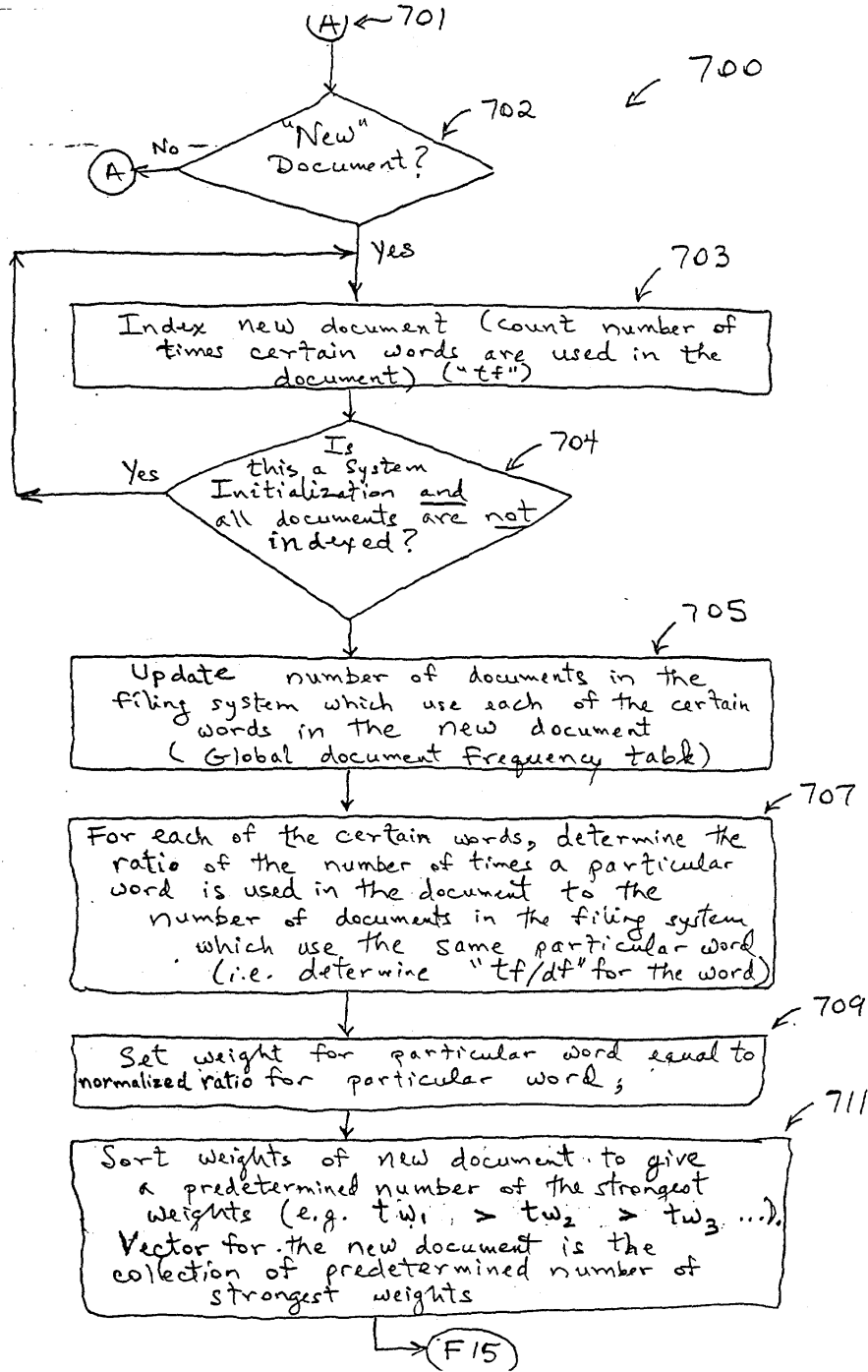

1288 10 SHEETS SQUARE
1289 100 SHEETS SQUARE
1290 100 SHEETS SQUARE



10/20/2000 10:00:00

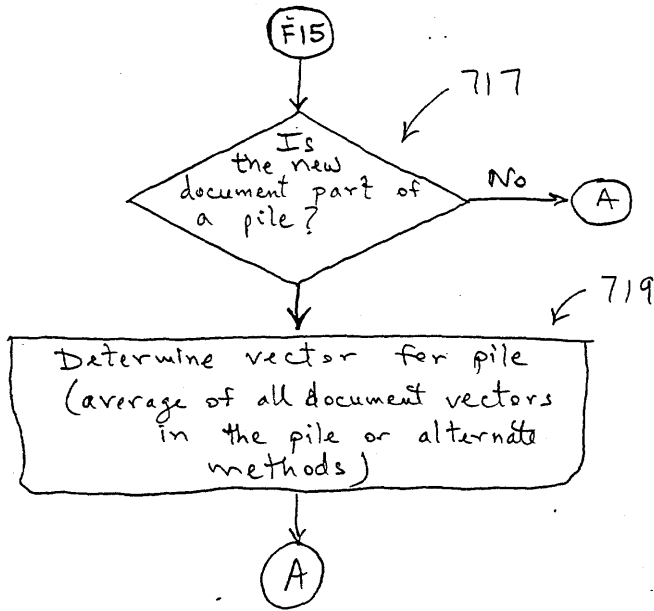

42,381 30 SHEETS 3 SQUARE
42,382 300 SHEETS 3 SQUARE
NATIONAL

FOR 200 26296/60

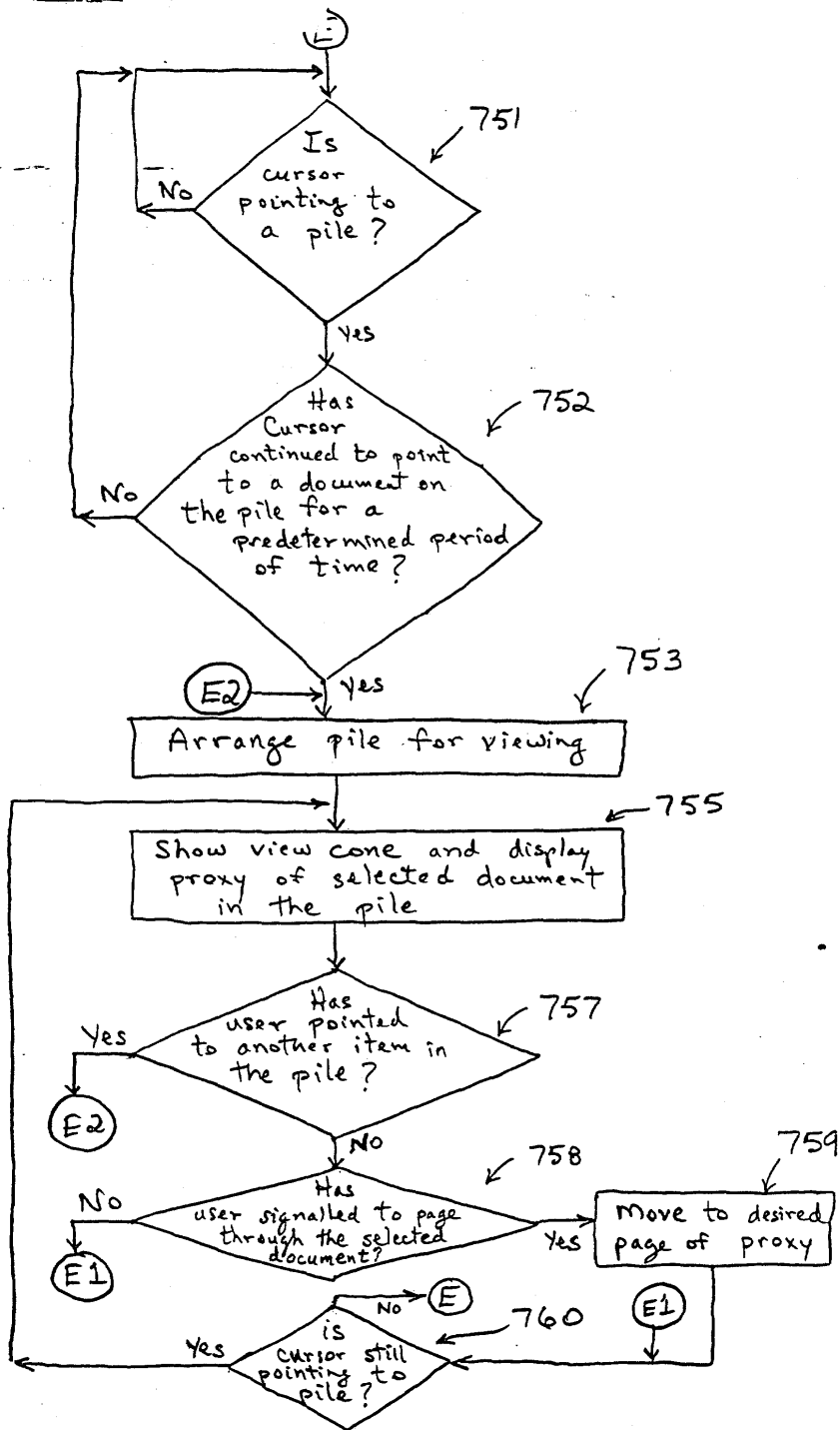
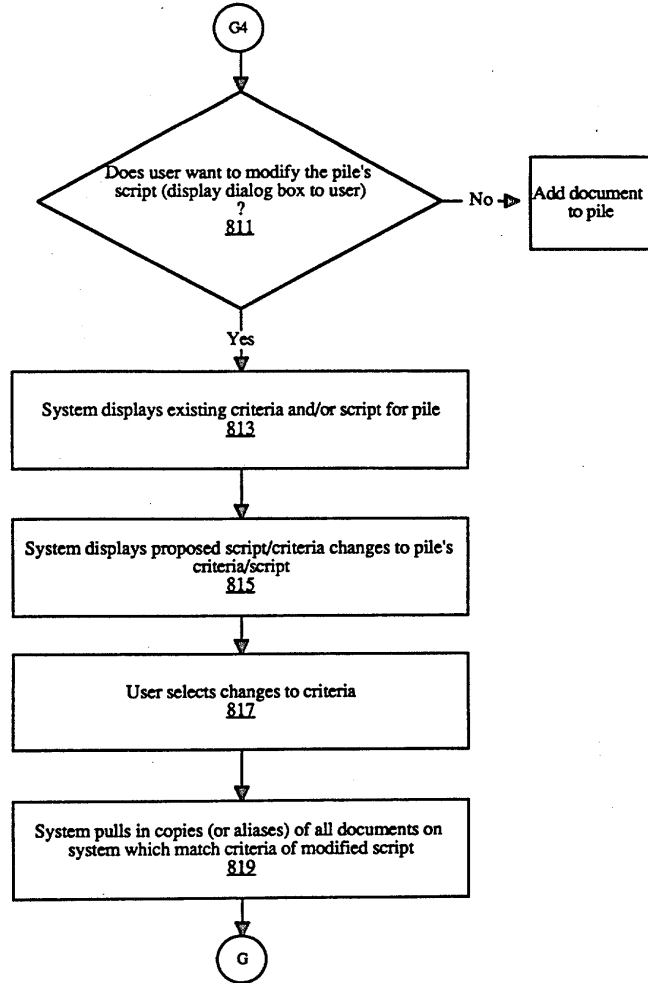
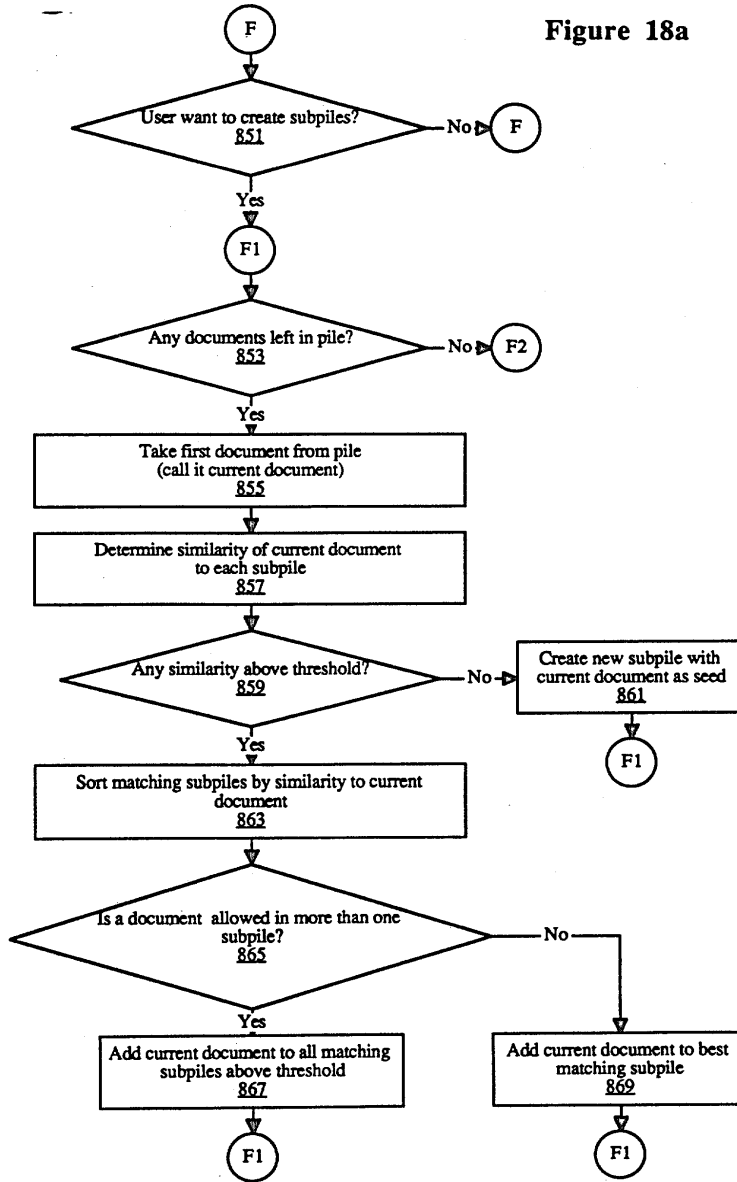

Figure 17 Continued



FOR "2000" 2000/06/06

Figure 18a



FOR 2025 RELEASE

Figure 18b

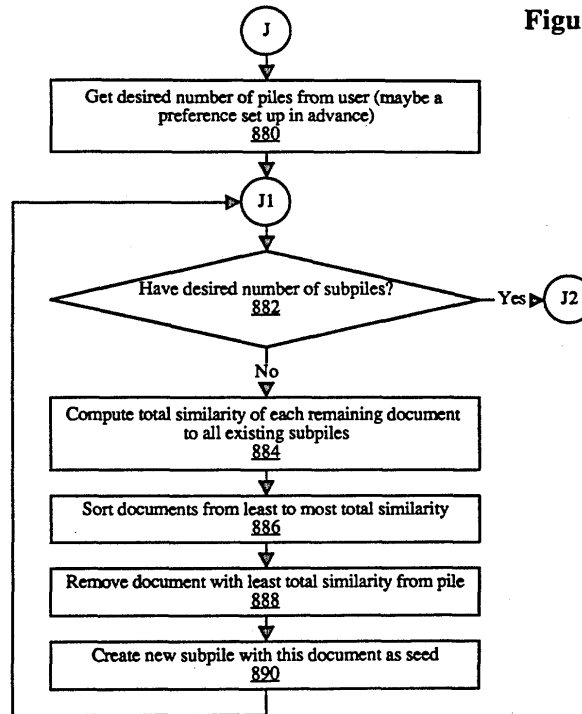

25295260

12 SHEETS 10 SQUARE
12 SHEETS 100 SQUARE
12 SHEETS 3 SQUARE
NATIONAL

FOUR 2666650

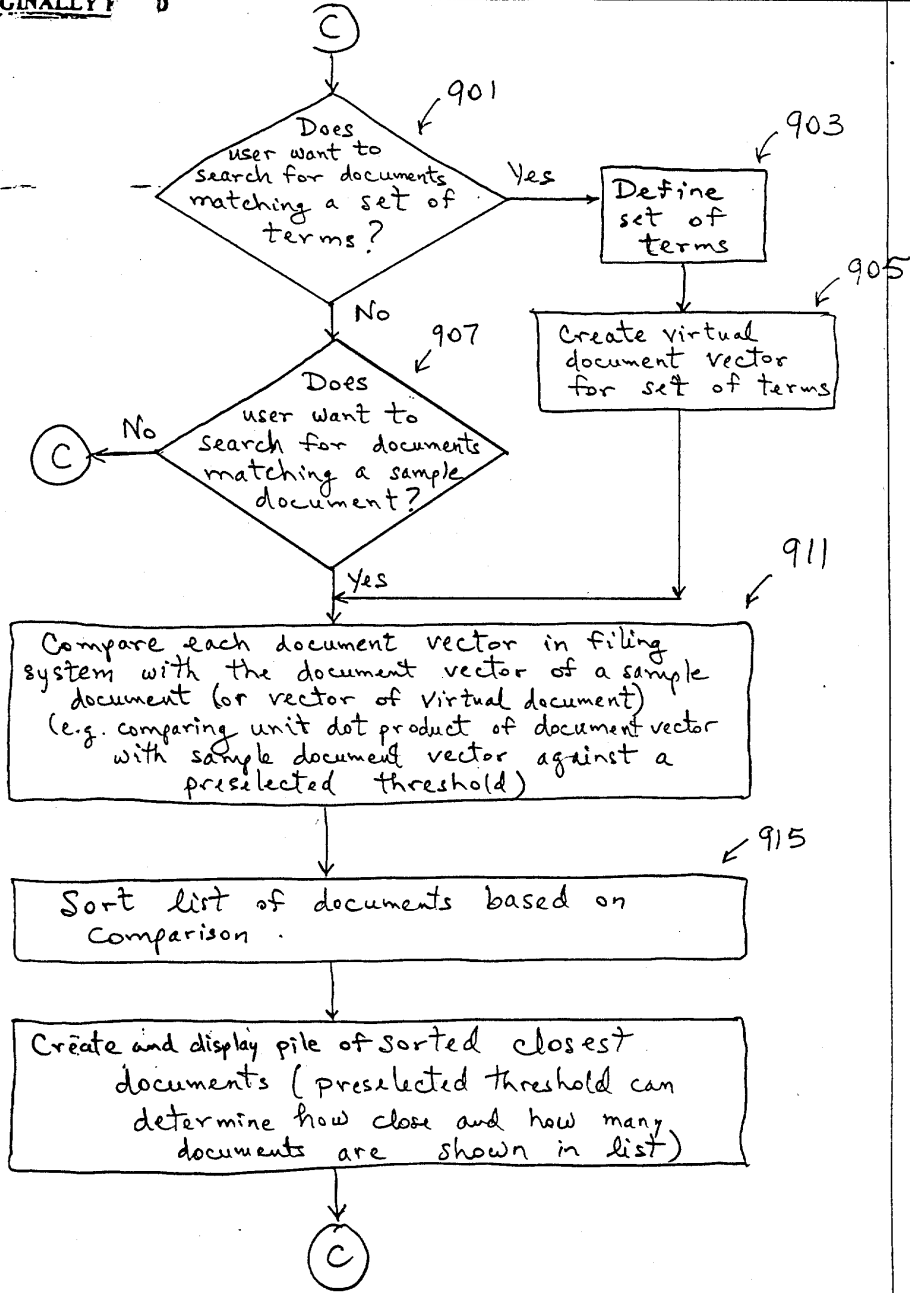

Figure 21
PRINT OF DRAWINGS
AS ORIGINALLY FI

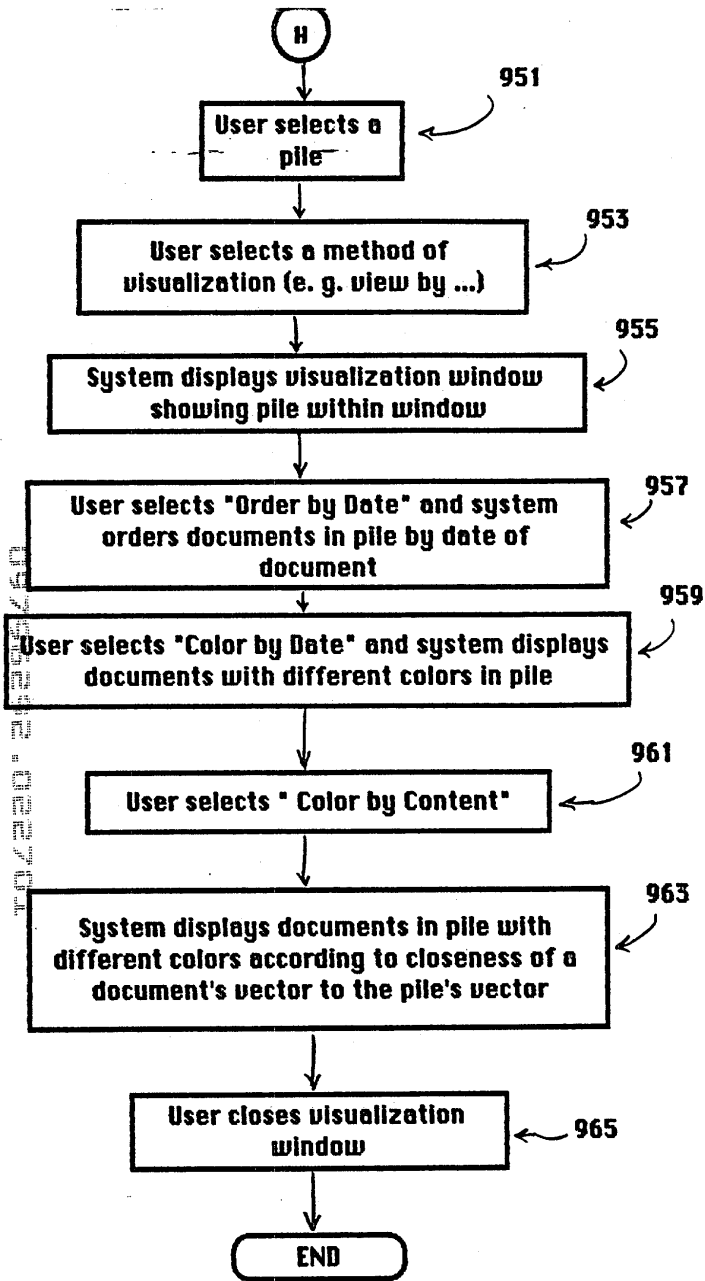
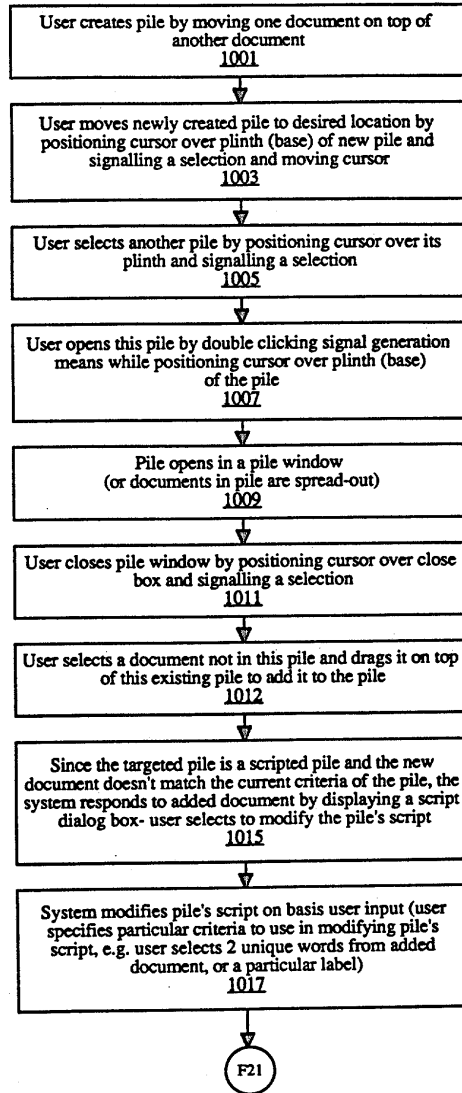
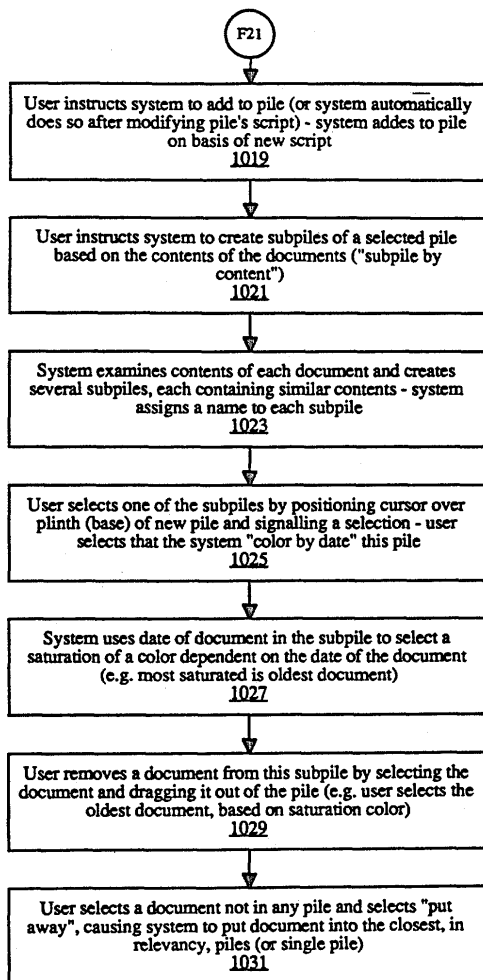

Figure 21



05750000 002700
10/22/00 2:02:05 PM

Figure 21 continued



097999 032704
FOI 200 26295760

PRINT OF DRAWINGS
AS ORIGINALLY FOUND

2204

2202

2203

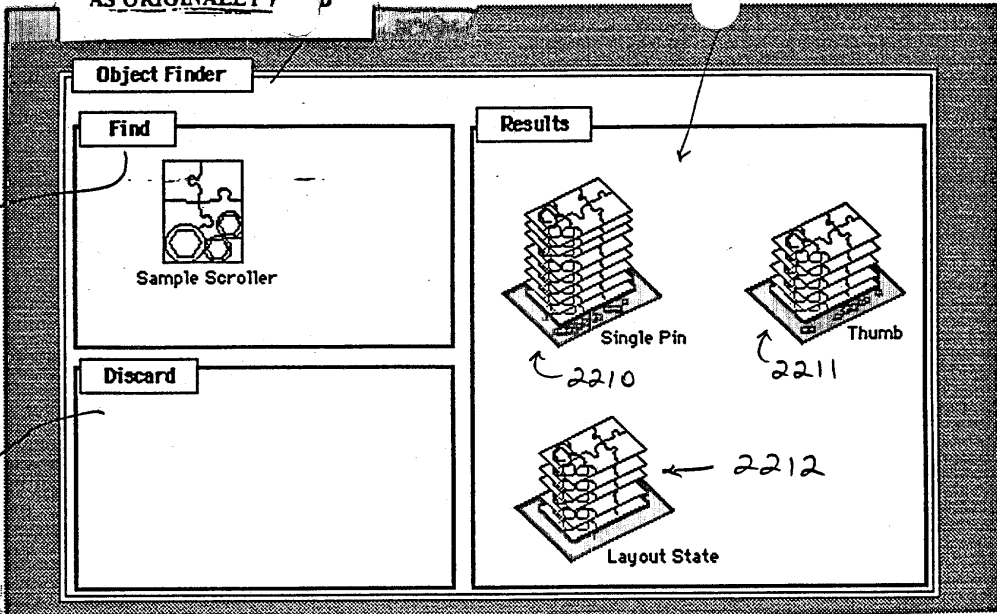

Figure 22a

09798293 022791
102220 26286740

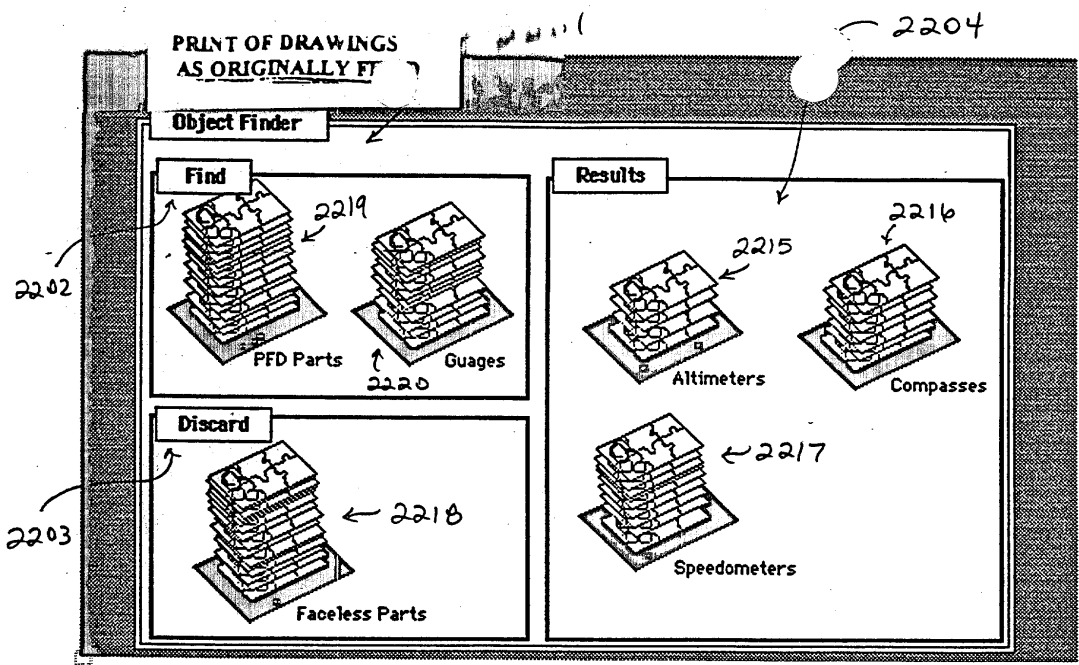

Figure 22b

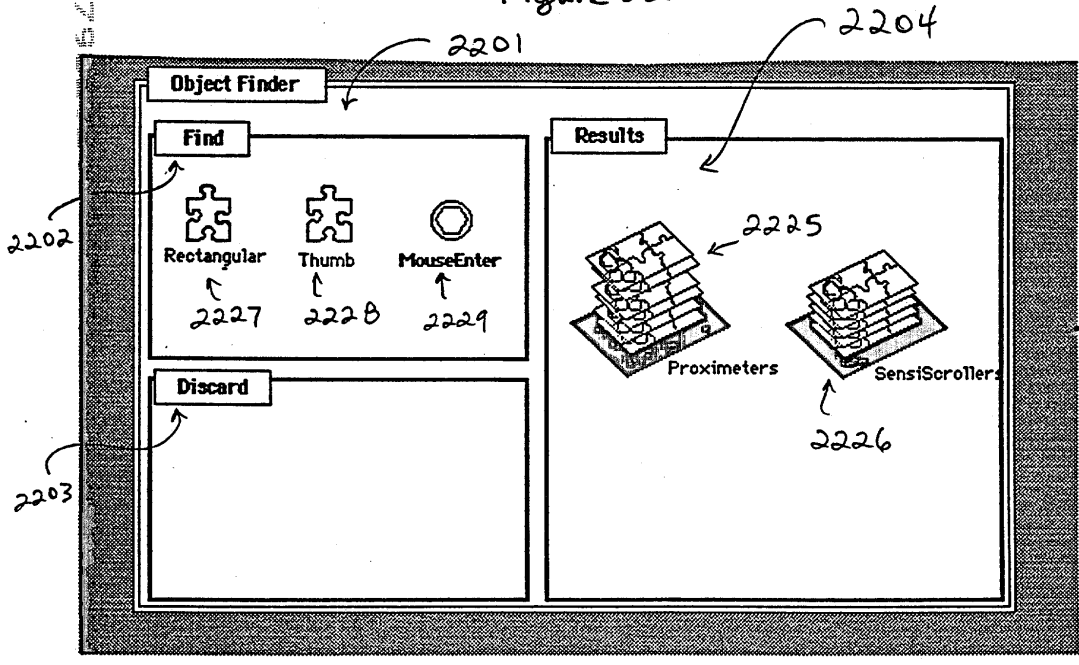

Figure 22c

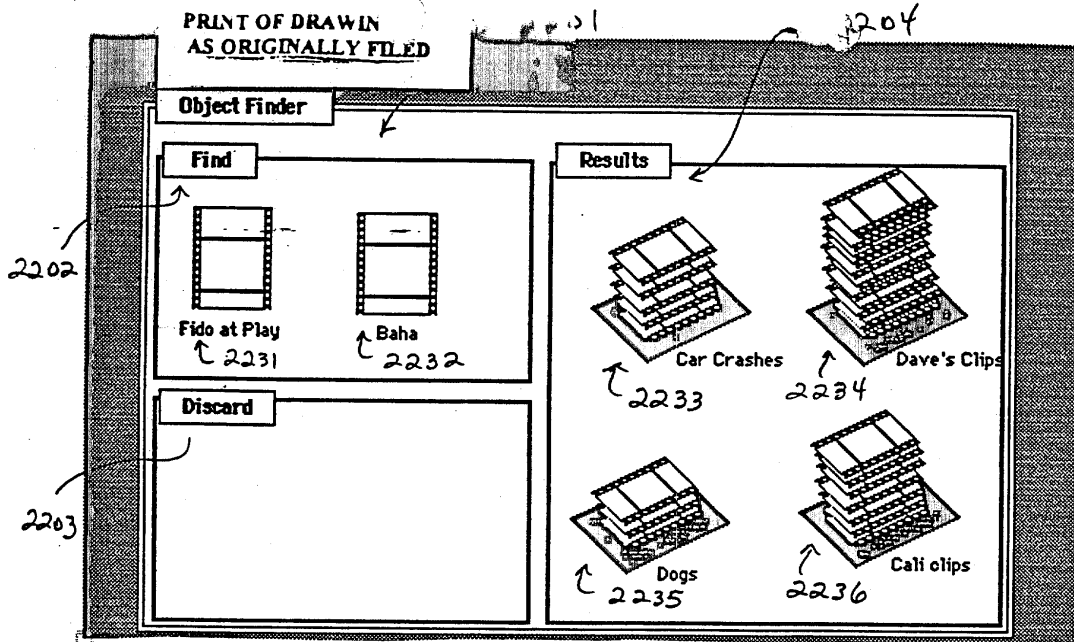

Figure 22d

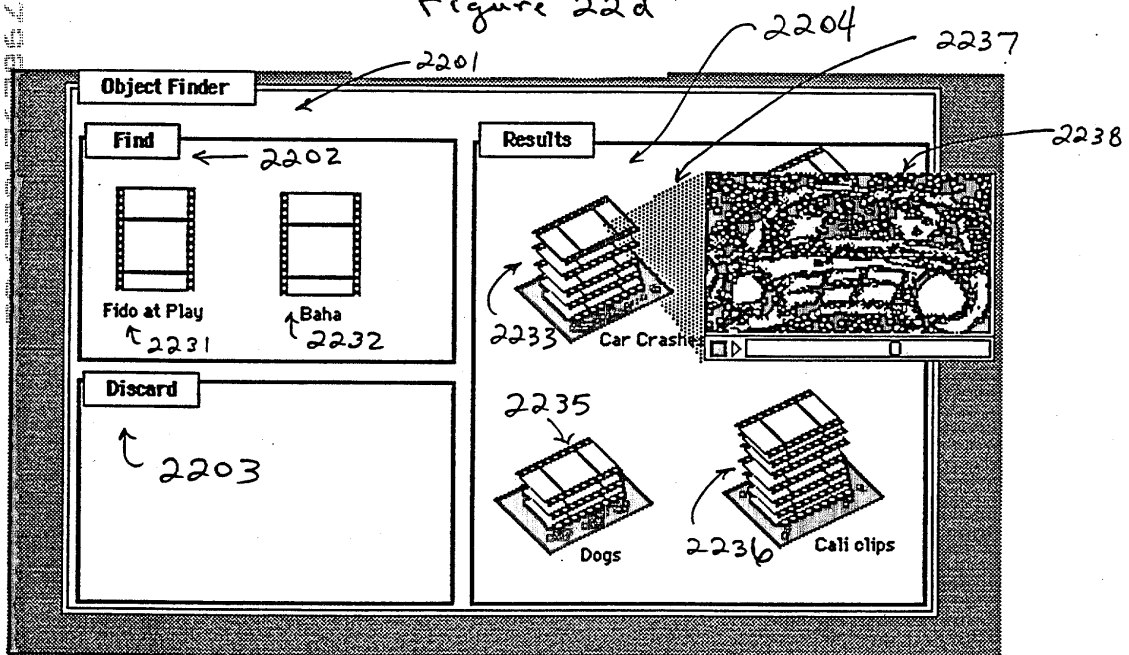

Figure 22e

03-1-01

A

Please type a plus sign (+) inside box [+]

PTO/SB/05 (11-00)

Approved for use through 10/31/2002. OMB 0651-0032
Patent and Trademark Office: U.S. DEPARTMENT OF COMMERCE

Under the Paperwork Reduction Act of 1995, no persons are required to respond to a collection of information unless it displays a valid OMB control number.

31042 U.S. PTO
02/27/01

UTILITY PATENT APPLICATION TRANSMITTAL
(Only for new nonprovisional applications under 37 CFR 1.53(b))

Attorney Docket No. 04860.P0624C2
(maximum 12 characters)

First Named Inventor Richard Mander, et al.

Title: METHOD AND APPARATUS FOR ORGANIZING INFORMATION IN A COMPUTER SYSTEM

Express Mail Label No. EL 821 799 985 US

31042 U.S. PTO
09796292
02/27/01

ADDRESS TO: Assistant Commissioner for Patents
Box Patent Application
Washington, D. C. 20231

APPLICATION ELEMENTS
See MPEP chapter 600 concerning utility patent application contents.

1. **Fee Transmittal Form (e.g., PTO/SB/17)**
(Submit an original, and a duplicate for fee processing)
2. **Applicant Claims Small Entity Status. (37 CFR 1.27)**
3. **Specification (Total Pages 92)**
(preferred arrangement set forth below)
 - Descriptive Title of the Invention
 - Cross Reference to Related Applications
 - Statement Regarding Fed sponsored R & D
 - Reference sequence listing, a table, or a computer program listing appendix
 - Background of the Invention
 - Brief Summary of the Invention
 - Brief Description of the Drawings (if filed)
 - Detailed Description
 - Claim(s)
 - Abstract of the Disclosure
4. **Drawings(s) (35 USC 113) (Total Sheets 28)**
5. **Oath or Declaration (Total Pages 3)**
 - a. Newly Executed (Original or Copy)
 - b. Copy from a Prior Application (37 CFR 1.63(d))
(for Continuation/Divisional with Box 17 completed)
 - i. **DELETIONS OF INVENTOR(S)** Signed statement attached deleting inventor(s) named in the prior application, see 37 CFR 1.63(d)(2) and 1.33(b).
 - c. Unsigned.
6. **Application Data Sheet. (37 CFR 1.76)**
7. **CD-ROM or CD-R in duplicate, large table or Computer Program (Appendix)**
8. **Nucleotide and/or Amino Acid Sequence Submission**
(if applicable, all necessary)
 - a. Computer Readable Form (CRF)
 - b. Specification Sequence Listing on:
 - i. CD-ROM or CD-R (2 copies); or
 - ii. paper
 - c. Statement verifying identity of above copies

09796292-022701

ACCOMPANYING APPLICATION PARTS

9. **Assignment Papers (cover sheet & documents(s))**

2/09/01

- 1 -

0796888 02404

10. a. Separable 37 CFR 3.73(b) Statement (where there is an assignee)
 b. Power of Attorney

11. English Translation Document (if applicable)

12. a. Information Disclosure Statement (IDS)/PTO-1449
 b. Copies of IDS Citations

13. Preliminary Amendment

14. Return Receipt Postcard (MPEP 503) (Should be specifically itemized)

15. Certified Copy of Priority Document(s) (if foreign priority is claimed)

16. Request and Certification under 35 U.S.C. 122(b)(2)(B)(i). Applicant must attach form PTO/SB/35 or its equivalent.

17. Other: _____

18A. If a CONTINUING APPLICATION, check appropriate box and supply the requisite information:

Continuation Divisional Continuation-in-part (CIP)
 Of Prior Application No.: 08/287,108 Examiner J. Feld Group Art Unit 2776
 (which is a continuation/ divisional/ CIP of prior application no. 07/876,921.)

Applicant(s): Also include a Preliminary Amendment to amend the specification to claim priority.
For CONTINUATION AND DIVISIONAL APPS only: The entire disclosure of the prior application, from which an oath or declaration is supplied under Box 5b, is considered a part of the disclosure of the accompanying continuation or divisional application and is hereby incorporated by reference. The incorporation can only be relied upon when a portion has been inadvertently omitted from the submitted application parts.

18B. Statement under 37 CFR 3.73(b) for continuing application:

The undersigned states that _____ (name of assignee) is the assignee of the entire right, title, and interest in the accompanying patent application by virtue of an assignment recorded in the Patent and Trademark Office at Reel No. _____ Frame No. _____ (or a copy of which is attached).

19. Correspondence Address

Customer Number or Bar Code Label _____
 or (Insert Customer No. or Attach Bar Code Label here)
 Correspondence Address Below

NAME James C. Scheller, Jr.

BLAKELY, SOKOLOFF, TAYLOR & ZAFMAN LLP

ADDRESS 12400 Wilshire Boulevard

Seventh Floor

CITY Los Angeles STATE California ZIP CODE 90025-1026

Country U.S.A. TELEPHONE (408) 720-8300 FAX (408) 720-9397

Name (PRINT/TYPE): James C. Scheller, Jr. Registration No.: 31,195

Signature: *James C. Scheller, Jr.* Date: 2/27/2001

PTO/SB/35(11-00)

Approved for use through 10/31/2002. OMB 0651-0031

U.S. Patent and Trademark Office: U.S. DEPARTMENT OF COMMERCE

Under the Paperwork Reduction Act of 1995, no persons are required to respond to a collection of information unless it displays a valid OMB control number.

FEE TRANSMITTAL FOR FY 2001

TOTAL AMOUNT OF PAYMENT (\$) 1226.00

Complete if Known:

Application No. _____
 Filing Date February 27, 2001
 First Named Inventor Richard Mander, et al.
 Group Art Unit _____
 Examiner Name _____
 Attorney Docket No. 04860P0624C2

10915 U.S. PTO
 09/19/02

 02/27/01

METHOD OF PAYMENT (check one)

1. The Commissioner is hereby authorized to charge indicated fees and credit any over payments to:
 Deposit Account Number 02-2666
 Deposit Account Name _____
- Charge Any Additional Fee Required Under 37 CFR 1.16 and 1.17
- Applicant claims small entity status. See 37 CFR 1.27
-
2. Payment Enclosed: Check
 Credit Card
 Money Order
 Other

FEE CALCULATION

1. BASIC FILING FEE

Large Entity		Small Entity		Fee Description	Fee Paid
Fee Code	Fee (\$)	Fee Code	Fee (\$)		
101	710	201	355	Utility application filing fee	\$710.00
106	320	206	160	Design application filing fee	_____
107	490	207	245	Plant filing fee	_____
108	710	208	355	Reissue filing fee	_____
114	150	214	75	Provisional application filing fee	_____
SUBTOTAL (1)\$					<u>710.00</u>

2. EXTRA CLAIM FEES

	Extra	Fee from below	Fee Paid
Total Claims <u>22</u> - <u>20</u> = <u>2</u> X <u>18.00</u> = <u>36.00</u>			
Independent Claims <u>9</u> - <u>3</u> = <u>6</u> X <u>80.00</u> = <u>480.00</u>			
Multiple Dependent Claims <u>0</u> X = <u>0</u>			

**Or number previously paid, if greater; For Reissues, see below.

Large Entity		Small Entity		Fee Description	Fee Paid
Fee Code	Fee (\$)	Fee Code	Fee (\$)		
103	18	203	9	Claims in excess of 20	_____
102	80	202	40	Independent claims in excess of 3	_____
104	270	204	135	Multiple dependent claim, if not paid	_____
109	80	209	40	**Reissue independent claims over original patent	_____
110	18	210	9	**Reissue claims in excess of 20 and over original patent	_____
SUBTOTAL (2)\$					<u>516.00</u>

FEE CALCULATION (continued)

09796232 022701

0995555-02741

3. ADDITIONAL FEES

Large Entity		Small Entity		Fee Description	Fee Paid
Fee Code	Fee (\$)	Fee Code	Fee (\$)		
105	130	205	65	Surcharge - late filing fee or oath	_____
127	50	227	25	Surcharge - late provisional filing fee or cover sheet	_____
139	130	139	130	Non-English specification	_____
147	2,520	147	2,520	For filing a request for ex parte reexamination	_____
112	920*	112	920*	Requesting publication of SIR prior to Examiner action	_____
113	1,840*	113	1,840*	Requesting publication of SIR after Examiner action	_____
115	110	215	55	Extension for reply within first month	_____
116	390	216	195	Extension for reply within second month	_____
117	890	217	445	Extension for reply within third month	_____
118	1,390	218	695	Extension for reply within fourth month	_____
128	1,890	228	945	Extension for reply within fifth month	_____
119	310	219	155	Notice of Appeal	_____
120	310	220	155	Filing a brief in support of an appeal	_____
121	270	221	135	Request for oral hearing	_____
138	1,510	138	1,510	Petition to institute a public use proceeding	_____
140	110	240	55	Petition to revive - unavoidable	_____
141	1,240	241	620	Petition to revive - unintentional	_____
142	1,240	242	620	Utility issue fee (or reissue)	_____
143	440	243	220	Design issue fee	_____
144	600	244	300	Plant issue fee	_____
122	130	122	130	Petitions to the Commissioner	_____
123	50	123	50	Processing fee under 37 CFR 1.17(q)	_____
126	180	126	180	Submission of Information Disclosure Stmt	_____
581	40	581	40	Recording each patent assignment per property (times number of properties)	_____
146	710	246	355	For filing a submission after final rejection (see 37 CFR 1.129(a))	_____
149	710	249	355	For each additional invention to be examined (see 37 CFR 1.129(b))	_____
179	710	279	355	Request for Continued Examination (RCE)	_____
169	900	169	900	Request for expedited examination of a design application	_____
195	300	195	300	Publication fee for early, voluntary, or normal publication	_____
196	300	196	300	Publication fee for republication	_____
194	130	194	130	Request for voluntary publication or republication	_____
098	130	098	130	Processing fee under 37 CFR 1.17(i)	_____
091	1,240	091	1,240	Acceptance of unintentionally delayed claim for priority	_____

Other fee (specify) _____

Other fee (specify) _____

SUBTOTAL (3) \$ 0

*Reduced by Basic Filing Fee Paid

SUBMITTED BY:

Typed or Printed Name: James C. Scheller, Jr.

Signature: *J. Scheller* Date: 2/27/2001

Reg. Number: 31,195 Telephone Number: (408) 720-8300

WARNING: Information on this form may become public. Credit card information should not be included on this form. Provide credit card information and authorization on PTO-2038.

FEE TRANSMITTAL FOR FY 2001

TOTAL AMOUNT OF PAYMENT (\$) 1226.00

Complete if Known:
 Application No. _____
 Filing Date February 27, 2001
 First Named Inventor Richard Mander, et al.
 Group Art Unit _____
 Examiner Name _____
 Attorney Docket No. 04860P0624C2

09/15 U.S. PTO
 09/19/01
 02/27/01

METHOD OF PAYMENT (check one)

1. The Commissioner is hereby authorized to charge indicated fees and credit any over payments to:
 Deposit Account Number 02-2666
 Deposit Account Name _____
- Charge Any Additional Fee Required Under 37 CFR 1.16 and 1.17
- Applicant claims small entity status. See 37 CFR 1.27

2. Payment Enclosed: Check
 Credit Card
 Money Order
 Other

FEE CALCULATION

1. BASIC FILING FEE

Large Entity		Small Entity		Fee Description	Fee Paid
Code	Fee (\$)	Code	Fee (\$)		
101	710	201	355	Utility application filing fee	<u>\$710.00</u>
106	320	206	160	Design application filing fee	_____
107	490	207	245	Plant filing fee	_____
108	710	208	355	Reissue filing fee	_____
114	150	214	75	Provisional application filing fee	_____
SUBTOTAL (1)\$					<u>710.00</u>

2. EXTRA CLAIM FEES

	Extra	Fee from below	Fee Paid
Total Claims <u>22</u> - 20 = <u>2</u> X <u>18.00</u> = <u>36.00</u>			
Independent Claims <u>9</u> - 3 = <u>6</u> X <u>80.00</u> = <u>480.00</u>			
Multiple Dependent Claims <u>0</u> X _____ = <u>0</u>			

**Or number previously paid, if greater; For Reissues, see below.

Large Entity		Small Entity		Fee Description	Fee Paid
Code	Fee (\$)	Code	Fee (\$)		
103	18	203	9	Claims in excess of 20	_____
102	80	202	40	Independent claims in excess of 3	_____
104	270	204	135	Multiple dependent claim, if not paid	_____
109	80	209	40	**Reissue independent claims over original patent	_____
110	18	210	9	**Reissue claims in excess of 20 and over original patent	_____
SUBTOTAL (2)\$					<u>516.00</u>

FEE CALCULATION (continued)

3. ADDITIONAL FEES

Large Entity		Small Entity		Fee Description	Fee Paid
Fee Code	Fee (\$)	Fee Code	Fee (\$)		
105	130	205	65	Surcharge - late filing fee or oath	_____
127	50	227	25	Surcharge - late provisional filing fee or cover sheet	_____
139	130	139	130	Non-English specification	_____
147	2,520	147	2,520	For filing a request for ex parte reexamination	_____
112	920*	112	920*	Requesting publication of SIR prior to Examiner action	_____
113	1,840*	113	1,840*	Requesting publication of SIR after Examiner action	_____
115	110	215	55	Extension for reply within first month	_____
116	390	216	195	Extension for reply within second month	_____
117	890	217	445	Extension for reply within third month	_____
118	1,390	218	695	Extension for reply within fourth month	_____
128	1,890	228	945	Extension for reply within fifth month	_____
119	310	219	155	Notice of Appeal	_____
120	310	220	155	Filing a brief in support of an appeal	_____
121	270	221	135	Request for oral hearing	_____
138	1,510	138	1,510	Petition to institute a public use proceeding	_____
140	110	240	55	Petition to revive - unavoidable	_____
141	1,240	241	620	Petition to revive - unintentional	_____
142	1,240	242	620	Utility issue fee (or reissue)	_____
143	440	243	220	Design issue fee	_____
144	600	244	300	Plant issue fee	_____
122	130	122	130	Petitions to the Commissioner	_____
123	50	123	50	Processing fee under 37 CFR 1.17(q)	_____
126	180	126	180	Submission of Information Disclosure Stmt	_____
581	40	581	40	Recording each patent assignment per property (times number of properties)	_____
146	710	246	355	For filing a submission after final rejection (see 37 CFR 1.129(a))	_____
149	710	249	355	For each additional invention to be examined (see 37 CFR 1.129(b))	_____
179	710	279	355	Request for Continued Examination (RCE)	_____
169	900	169	900	Request for expedited examination of a design application	_____
195	300	195	300	Publication fee for early, voluntary, or normal publication	_____
196	300	196	300	Publication fee for republication	_____
194	130	194	130	Request for voluntary publication or republication	_____
098	130	098	130	Processing fee under 37 CFR 1.17(l)	_____
091	1,240	091	1,240	Acceptance of unintentionally delayed claim for priority	_____
Other fee (specify) _____					_____
Other fee (specify) _____					_____
SUBTOTAL (3)\$ 0					

*Reduced by Basic Filing Fee Paid

SUBMITTED BY:

Typed or Printed Name: James C. Scheller, Jr.
 Signature: *J. Scheller* Date: 2/27/2001
 Reg. Number: 31,195 Telephone Number: (408) 720-8300

WARNING: Information on this form may become public. Credit card information should not be included on this form. Provide credit card information and authorization on PTO-2038.

1c915 U.S. PTO
09/796292
02/27/01

EXPRESS MAIL CERTIFICATE OF MAILING

"Express Mail" mailing label number: EL 821 799 98545
 Date of Deposit: FEBRUARY 27, 2001
 I hereby certify that I am causing this paper or fee to be deposited with the United States Postal Service "Express Mail Post Office to Addressee" service on the date indicated above and that this paper or fee has been addressed to the Assistant Commissioner for Patents, Washington, D. C. 20231
CONNIE THAYER
 (Typed or printed name of person mailing paper or fee)
Connie Thayer
 (Signature of person mailing paper or fee)
2-27-01
 (Date signed)

Serial/Patent No.: *** Filing/Issue Date: February 27, 2001
 Client: Apple Computer, Inc.
 Title: METHOD AND APPARATUS FOR ORGANIZING INFORMATION IN A COMPUTER SYSTEM
 BSTZ File No.: 04860.P0624C2 Atty/Secty Initials: JCS/clt
 Date Mailed: _____ Docket Due Date: _____

The following has been received in the U.S. Patent & Trademark Office on the date stamped hereon:

<input type="checkbox"/> Amendment/Response (____ pgs.)	<input checked="" type="checkbox"/> Express Mail No.: <u>EL821799985US</u> <input type="checkbox"/> Check No. <u>41127</u>
<input type="checkbox"/> Appeal Brief (____ pgs.) (in triplicate)	<input type="checkbox"/> _____ Month(s) Extension of Time
<input type="checkbox"/> Application - Utility (____ pgs., with cover and abstract)	<input checked="" type="checkbox"/> Information Disclosure Statement & PTO H&O (<u>3</u> pgs.) <input type="checkbox"/> Amt: <u>\$1226.00</u>
<input checked="" type="checkbox"/> Application - Rule 1.53(b) Continuation (<u>92</u> pgs.)	<input type="checkbox"/> Issue Fee Transmittal <u>1.93 (d)</u> <input type="checkbox"/> Check No. _____
<input type="checkbox"/> Application - Rule 1.53(b) Divisional (____ pgs.)	<input type="checkbox"/> Notice of Appeal
<input type="checkbox"/> Application - Rule 1.53(b) CIP (____ pgs.)	<input type="checkbox"/> Petition for Extension of Time
<input type="checkbox"/> Application - Rule 1.53(d) CPA Transmittal (____ pgs.)	<input type="checkbox"/> Petition for _____
<input type="checkbox"/> Application - Design (____ pgs.)	<input type="checkbox"/> Postcard
<input type="checkbox"/> Application - PCT (____ pgs.)	<input type="checkbox"/> Power of Attorney (____ pgs.)
<input type="checkbox"/> Application - Provisional (____ pgs.)	<input checked="" type="checkbox"/> Preliminary Amendment (<u>11</u> pgs.)
<input type="checkbox"/> Assignment and Cover Sheet	<input type="checkbox"/> Reply Brief (____ pgs.)
<input checked="" type="checkbox"/> Certificate of Mailing	<input type="checkbox"/> Response to Notice of Missing Parts
<input type="checkbox"/> Declaration & POA (____ pgs.)	<input type="checkbox"/> Small Entry Declaration for Indep. Inventor/Small Business
<input type="checkbox"/> Disclosure Docs & Orig & Copy of Invention Signed Letter (____ pgs.)	<input checked="" type="checkbox"/> Transmittal Letter, in duplicate <u>3</u> pages
<input type="checkbox"/> Drawings: _____ # of sheets includes _____ figures	<input type="checkbox"/> Fee Transmittal, in duplicate <u>2</u> pages

Other: Copy of parent appln serial no. 08/287,108 filed 8-8-94 (92pgs) with signed Declaration (3 pgs) and drawings (28 sheets).

PATENT APPLICATION SERIAL NO. _____

U.S. DEPARTMENT OF COMMERCE
PATENT AND TRADEMARK OFFICE
FEE RECORD SHEET

03/07/2001 MYUSUF1 00000012 09796292	
01 FC:101	710.00 OP
02 FC:103	35.00 OP
03 FC:102	480.00 OP

PTO-1556
(5/87)

*U.S. GPO: 2000-468-987/39595



UNITED STATES PATENT AND TRADEMARK OFFICE

COMMISSIONER FOR PATENTS
 UNITED STATES PATENT AND TRADEMARK OFFICE
 WASHINGTON, D.C. 20231
 www.uspto.gov

APPLICATION NUMBER	FILING/RECEIPT DATE	FIRST NAMED APPLICANT	ATTORNEY DOCKET NUMBER
09/796,292	02/27/2001	Richard Mander	04860.P0624C2

CONFIRMATION NO. 4465

FORMALITIES LETTER



OC00000005951713

James C. Scheller, Jr.
 BLAKELY, SOKOLOFF, TAYLOR & ZAFMAN LLP
 Seventh Floor
 12400 Wilshire Boulevard
 Los Angeles, CA 90025-1026

Date Mailed: 04/10/2001

NOTICE TO FILE CORRECTED APPLICATION PAPERS

Filing Date Granted

This application has been accorded an Application Number and Filing Date. The application, however, is informal since it does not comply with the regulations for the reason(s) indicated below. Applicant is given **TWO MONTHS** from the date of this Notice within which to correct the informalities indicated below. Extensions of time may be obtained by filing a petition accompanied by the extension fee under the provisions of 37 CFR 1.136(a)

The required item(s) identified below must be timely submitted to avoid abandonment:

- Substitute drawings in compliance with 37 CFR 1.84 because:
 - drawing sheets do not have the appropriate margin(s) (see 37 CFR 1.84(g)). Each sheet must include a top margin of at least 2.5 cm. (1 inch), a left side margin of at least 2.5 cm. (1 inch), a right side margin of at least 1.5 cm. (5/8 inch), and a bottom margin of at least 1.0 cm. (3/8 inch);

*A copy of this notice **MUST** be returned with the reply.*

S. Sahaio

Customer Service Center
 Initial Patent Examination Division (703) 308-1202

PART 3 - OFFICE COPY



TS

03CO

#3

ocket No. 04860.P0624C2

PATENT

IN THE UNITED STATES PATENT AND TRADEMARK OFFICE

Application of:)
 Richard Mander, et al.)
 Application No. 09/796,292)
 Filed: February 27, 2001)
 For: METHOD AND APPARATUS FOR)
 ORGANIZING INFORMATION IN A)
 COMPUTER SYSTEM)

Examiner: not yet assigned
Art Unit: 2673

Asst. Commissioner for Patents
Washington, D.C. 20231

RESPONSE TO NOTICE TO FILE CORRECTED APPLICATION PAPERS
(FILING DATE GRANTED)

Sir:

In response to the Notice to File Corrected Application Papers (Filing Date Granted) mailed April 10, 2001, please find enclosed:

- (1) a set of substitute drawings with appropriate margins, comprising twenty-eight (28) sheets and sixty-three (63) figures; and
- (2) a copy of the Notice to File Corrected Application Papers.

If any additional fee is required, please charge Deposit Account No. 02-2666. A duplicate of this Response is enclosed for deposit account charging purposes.

Respectfully submitted,
BLAKELY, SOKOLOFF, TAYLOR & ZAFMAN

Dated: 5/9, 2001

James C. Scheller, Jr.
Reg. No. 31,195

12400 Wilshire Blvd.
Seventh Floor
Los Angeles, CA 90025-1026
(408) 720-8300

I hereby certify that this correspondence is being deposited with the United States Postal Service as first class mail with sufficient postage in an envelope addressed to the Assistant Commissioner for Patents, Washington, D.C. 20231

on 5/9/01
 Date of Deposit
DINAH ROMERO
 Name of Person Filing Correspondence
Dinah Romero 5/9/01
 Signature Date



Docket No. 04860.P0624C2

PATENT

IN THE UNITED STATES PATENT AND TRADEMARK OFFICE

Re Application of:

Richard Mander, et al.

Examiner: not yet assigned

Application No. 09/796,292

Art Unit: 2673

Filed: February 27, 2001

For: METHOD AND APPARATUS FOR ORGANIZING INFORMATION IN A COMPUTER SYSTEM

Asst. Commissioner for Patents
Washington, D.C. 20231

RESPONSE TO NOTICE TO FILE CORRECTED APPLICATION PAPERS
(FILING DATE GRANTED)

Sir:

In response to the Notice to File Corrected Application Papers (Filing Date Granted) mailed April 10, 2001, please find enclosed:

- (1) a set of substitute drawings with appropriate margins, comprising twenty-eight (28) sheets and sixty-three (63) figures; and
- (2) a copy of the Notice to File Corrected Application Papers.

If any additional fee is required, please charge Deposit Account No. 02-2666. A duplicate of this Response is enclosed for deposit account charging purposes.

Respectfully submitted,
BLAKELY, SOKOLOFF, TAYLOR & ZAFMAN

Dated: 5/9, 2001

ORIGINAL SIGNED BY

James C. Scheller, Jr.
Reg. No. 31,195

12400 Wilshire Blvd.
Seventh Floor
Los Angeles, CA 90025-1026
(408) 720-8300

I hereby certify that this correspondence is being deposited with the United States Postal Service as first class mail with sufficient postage in an envelope addressed to the Assistant Commissioner for Patents, Washington, D.C. 20231

on 5/9/01
 Date of Deposit
DINAH ROMERO
 Name of Person Making Correspondence
Dinah Romero 5/9/01
 Signature Date

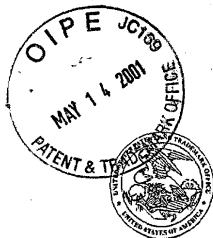

UNITED STATES PATENT AND TRADEMARK OFFICE

COMMISSIONER FOR PATENTS
UNITED STATES PATENT AND TRADEMARK OFFICE
WASHINGTON, D.C. 20231
www.uspto.gov

APPLICATION NUMBER	FILING/RECEIPT DATE	FIRST NAMED APPLICANT	ATTORNEY DOCKET NUMBER
09/796,292	02/27/2001	Richard Mander	04860.P0624C2

CONFIRMATION NO. 4465

FORMALITIES LETTER



James C. Scheller, Jr.
BLAKELY, SOKOLOFF, TAYLOR & ZAFMAN LLP
Seventh Floor
12400 Wilshire Boulevard
Los Angeles, CA 90025-1026

Date Mailed: 04/10/2001

NOTICE TO FILE CORRECTED APPLICATION PAPERS

Filing Date Granted

This application has been accorded an Application Number and Filing Date. The application, however, is informal since it does not comply with the regulations for the reason(s) indicated below. Applicant is given **TWO MONTHS** from the date of this Notice within which to correct the informalities indicated below. Extensions of time may be obtained by filing a petition accompanied by the extension fee under the provisions of 37 CFR 1.136(a)

The required item(s) identified below must be timely submitted to avoid abandonment:

- Substitute drawings in compliance with 37 CFR 1.84 because:
 - drawing sheets do not have the appropriate margin(s) (see 37 CFR 1.84(g)). Each sheet must include a top margin of at least 2.5 cm. (1 inch), a left side margin of at least 2.5 cm. (1 inch), a right side margin of at least 1.5 cm. (5/8 inch), and a bottom margin of at least 1.0 cm. (3/8 inch);

*A copy of this notice **MUST** be returned with the reply.*

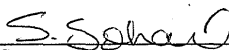
Customer Service Center
Initial Patent Examination Division (703) 308-1202

PART 2 - COPY TO BE RETURNED WITH RESPONSE

6613101

09796292 051101

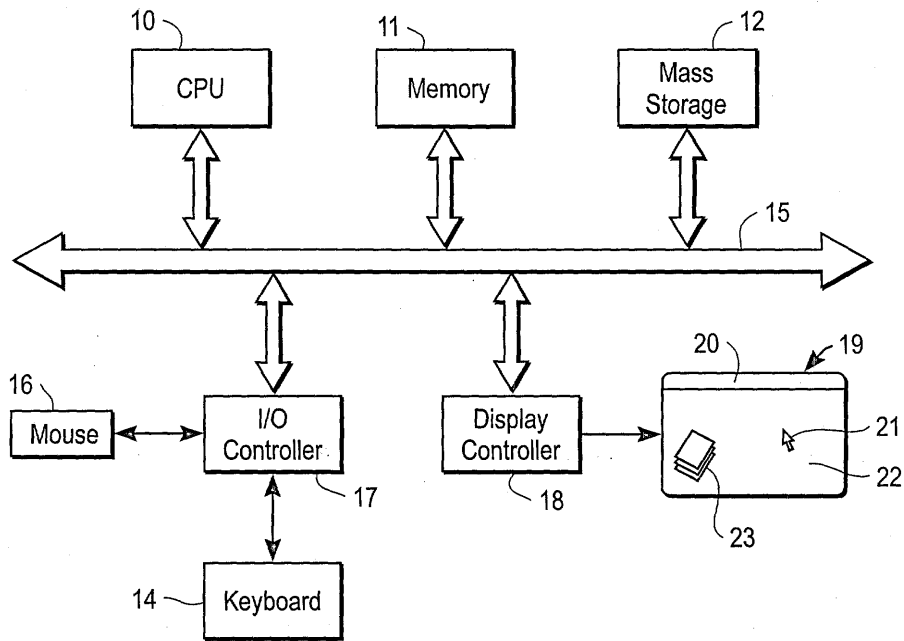

FIG. 1

FIG. 2a

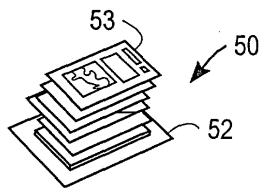

FIG. 2a

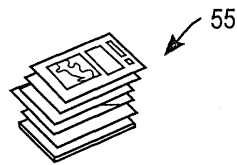

FIG. 2b

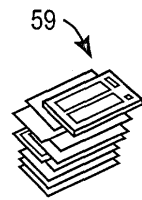

FIG. 2c

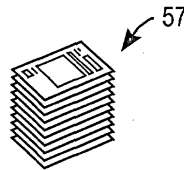

FIG. 2d

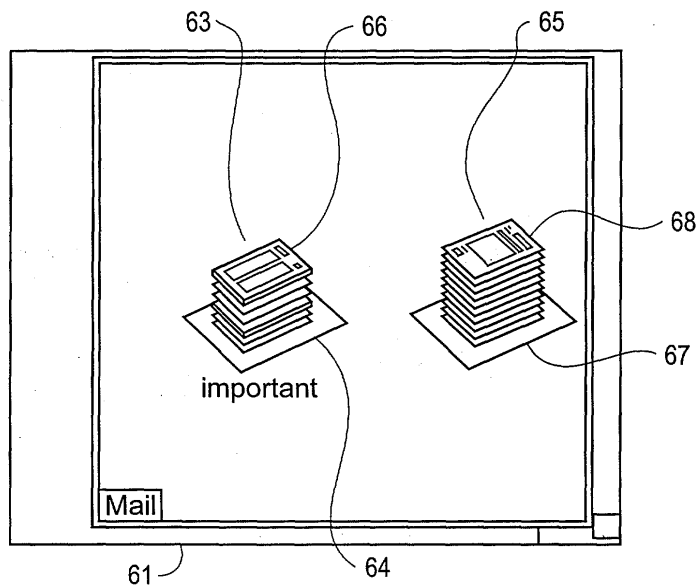

FIG. 2e

0979699 05144
FOI# 26296260

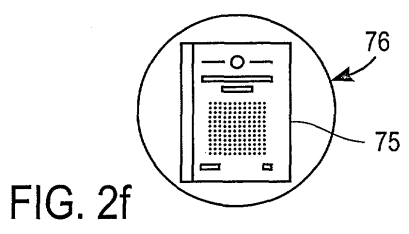

FIG. 2f

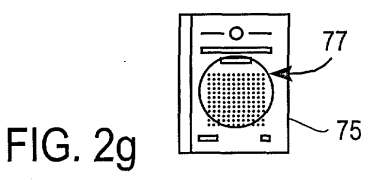

FIG. 2g

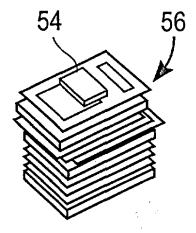

FIG. 2h

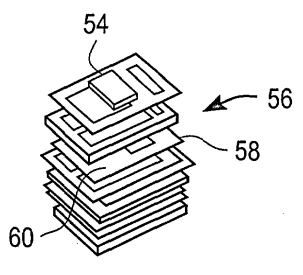

FIG. 2i

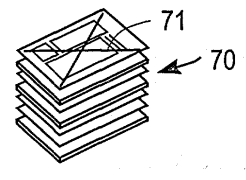

FIG. 2j

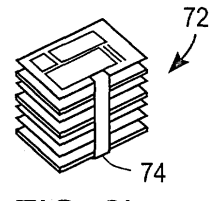

FIG. 2k

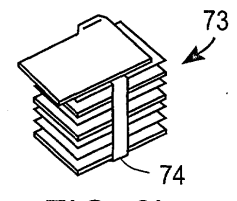

FIG. 2l

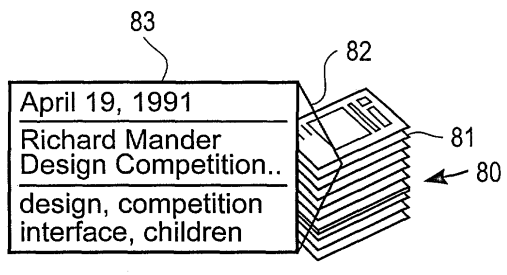

FIG. 4f

09/96299-05440

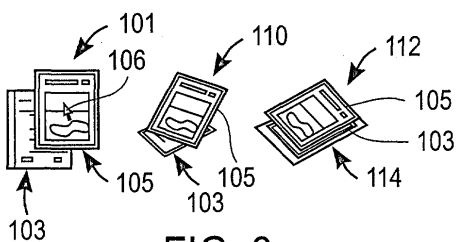

FIG. 3

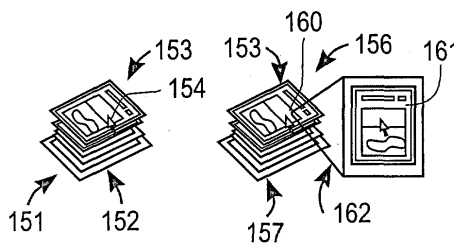

FIG. 4a

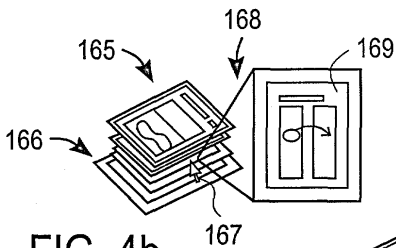

FIG. 4b

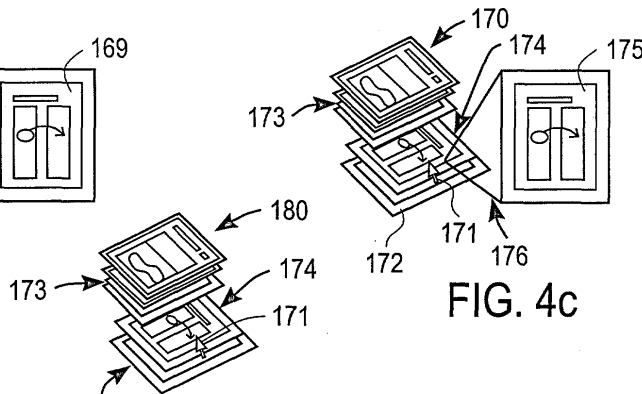

FIG. 4c

FIG. 4d

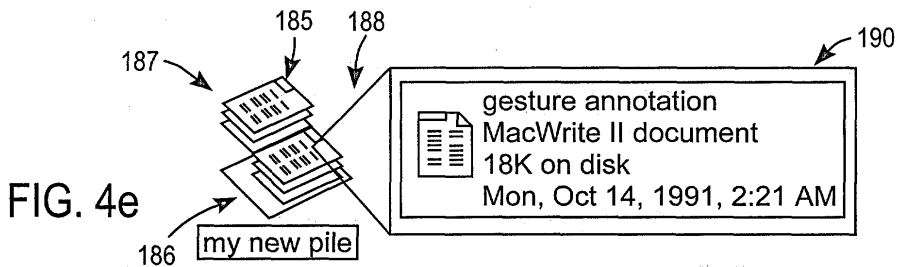

FIG. 4e

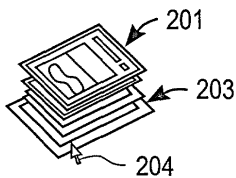

FIG. 5a

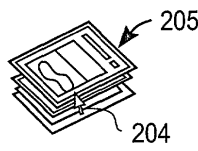



FIG. 5b

126

pg7/10

It occurs to me that it would be a worthwhile exercise to crystallize our vision of One way to do this is to put together a video script (whether or not any video is ever made).

What are the (two or three?) important ideas? Why will a be more interesting than anything else that will be around in a couple of years? What are the illustrative uses for why is tres cool)?

Find: Blackstone  start

Who is the audience for for us, to clarify what is important and interesting, the actual video, if any, could be for internal advertising (i.e., for other groups that we hope will do things for us and with us and for executive staff to keep resources coming); it could also be for external consumption to create demand for and interest in the kind of stuff we're doing.

What do I want from you? Anything you have on the questions above.

127

FIG. 4g

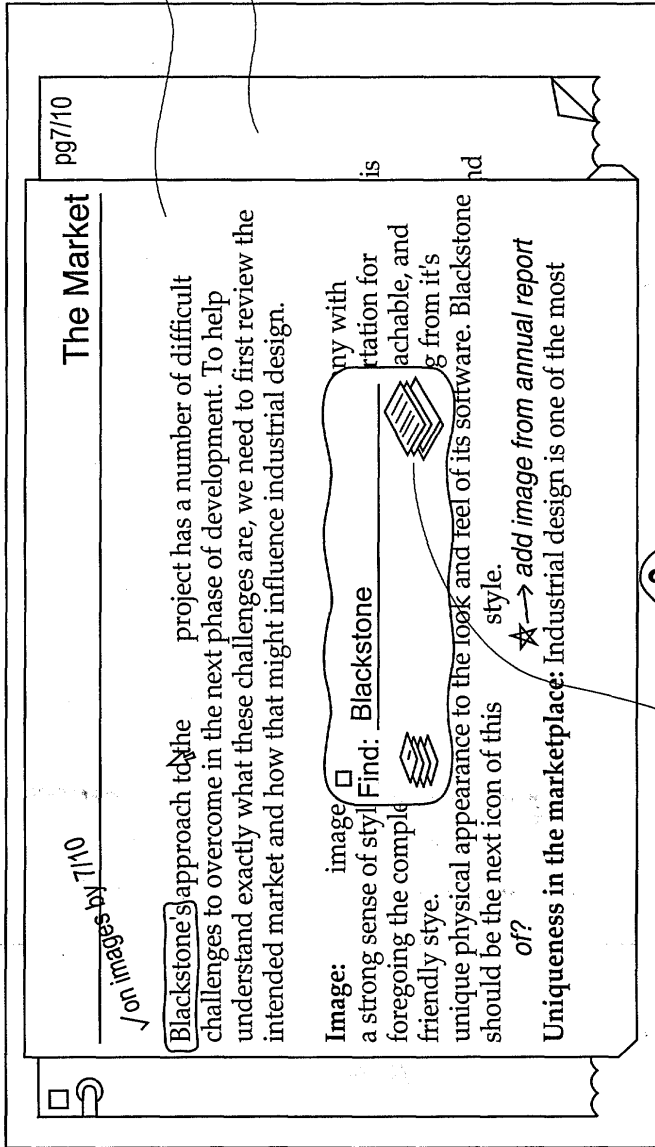

FIG. 4h

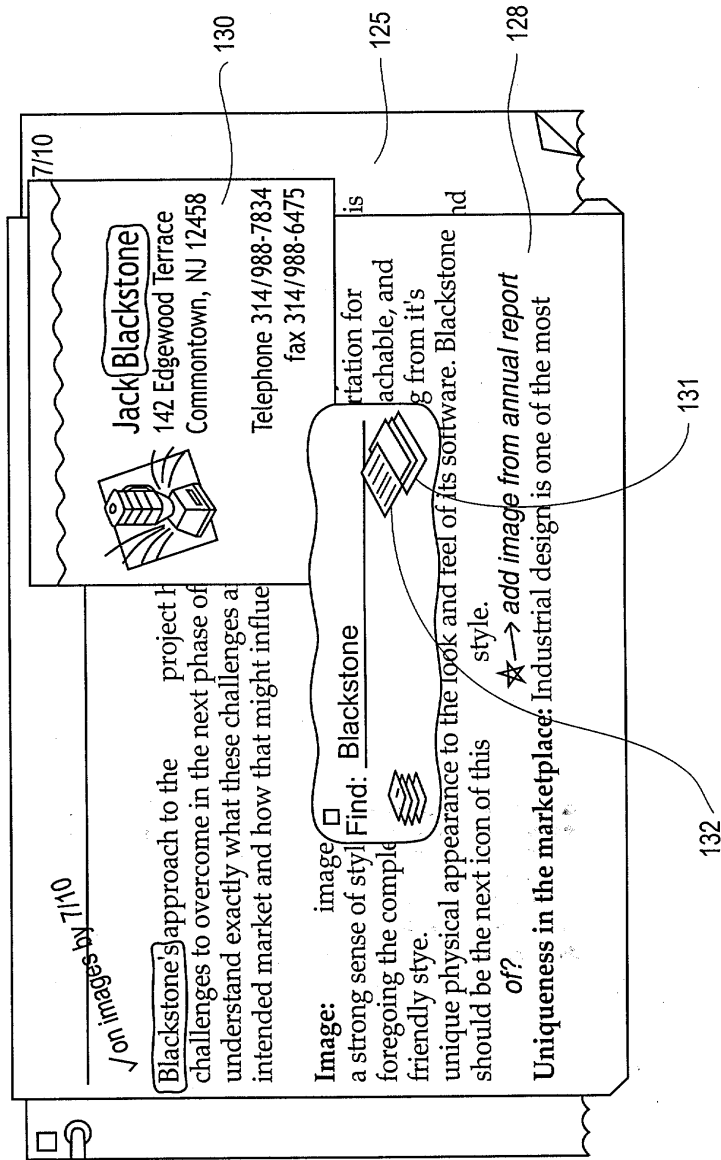

FIG. 4i

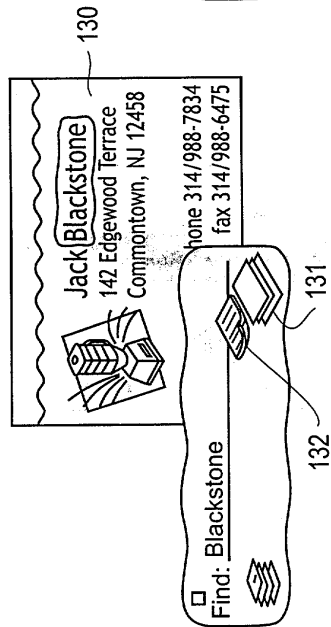

FIG. 4j

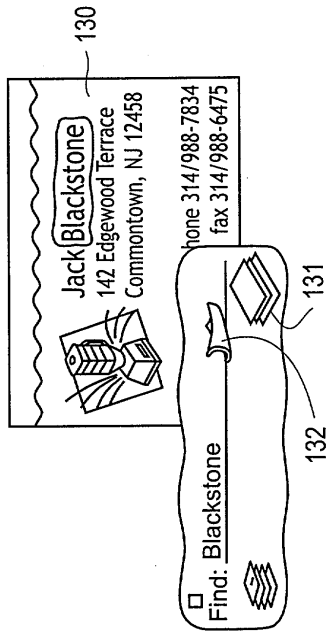

FIG. 4k

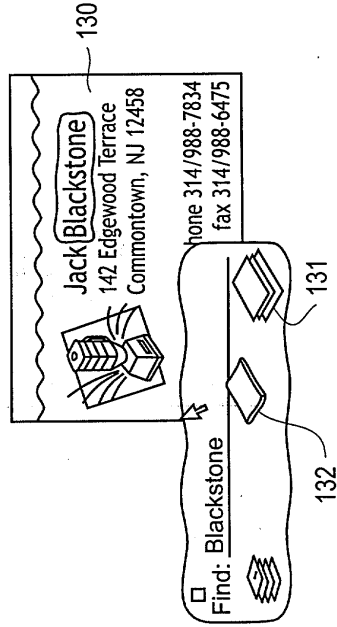

FIG. 4l

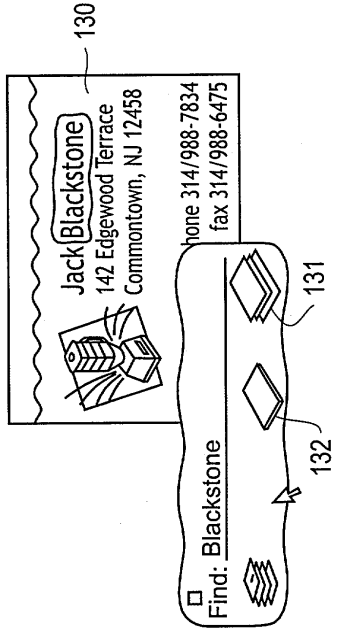

FIG. 4m

FIG. 6

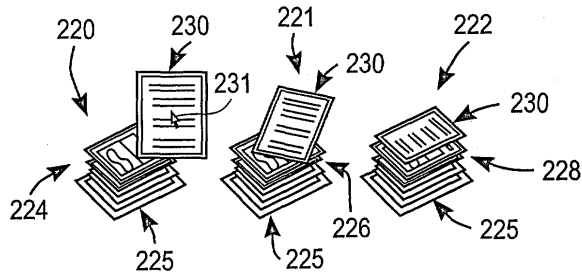

FIG. 6

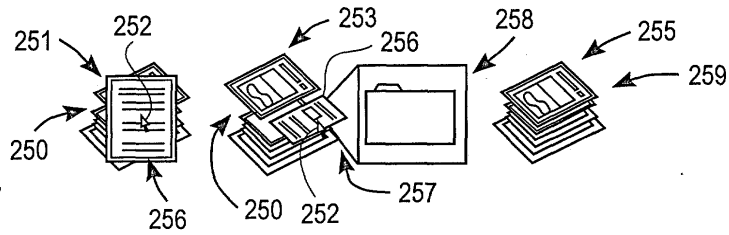

FIG. 7

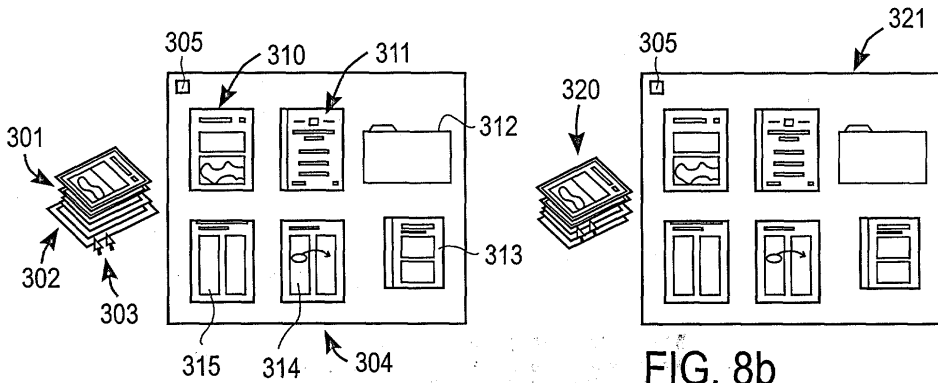

FIG. 8a

FIG. 8b

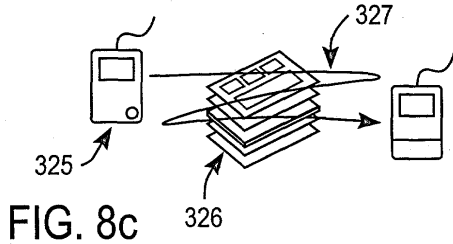

FIG. 8c

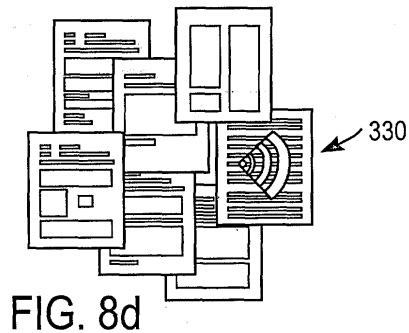

FIG. 8d

FIG. 9a

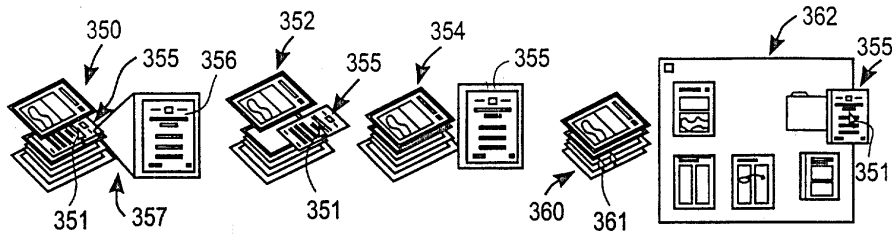

FIG. 9a

FIG. 9b

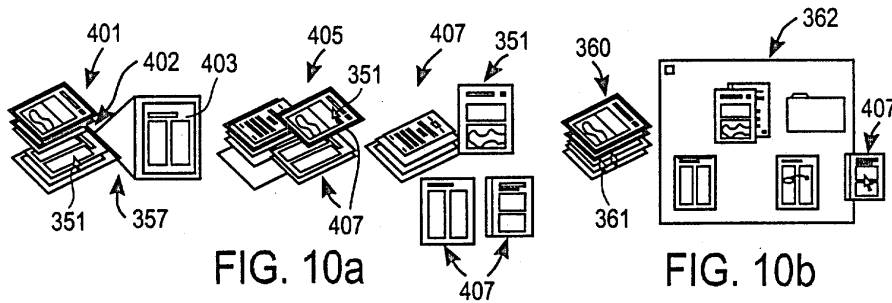

FIG. 10a

FIG. 10b

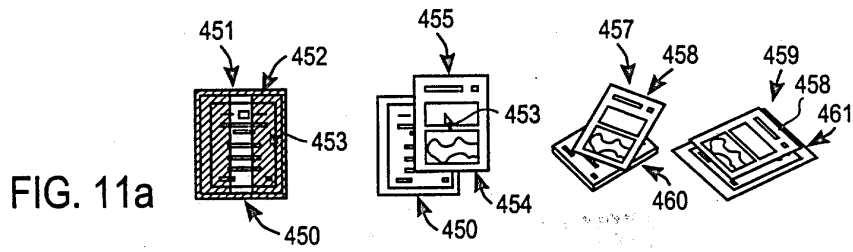

FIG. 11a

FIG. 11b

00796292 104150 26296760

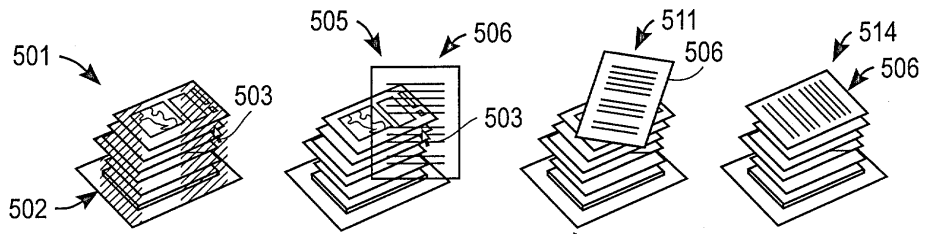

FIG. 12a

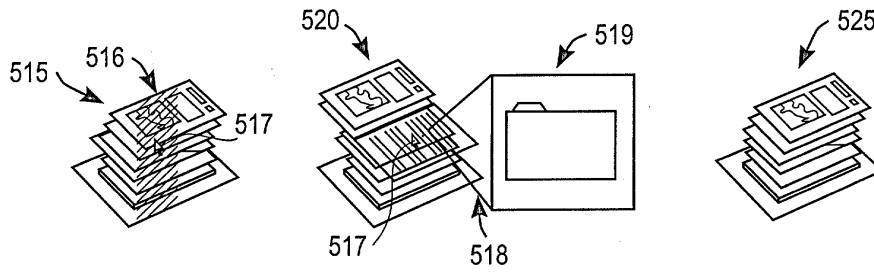

FIG. 12b

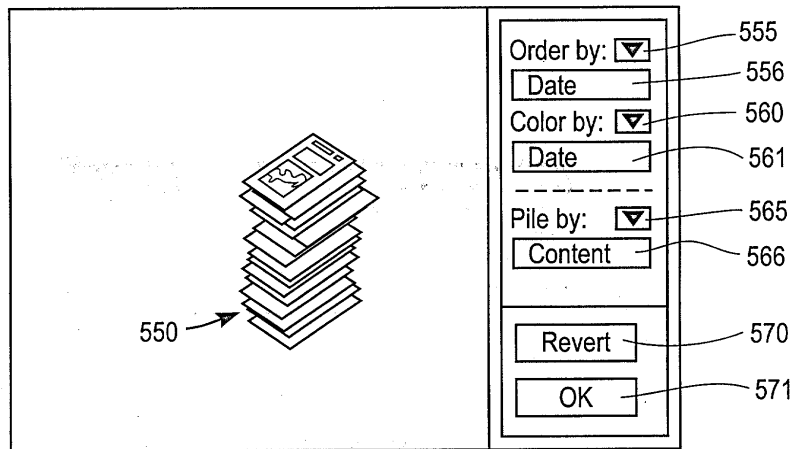

FIG. 13a

FIG. 13b

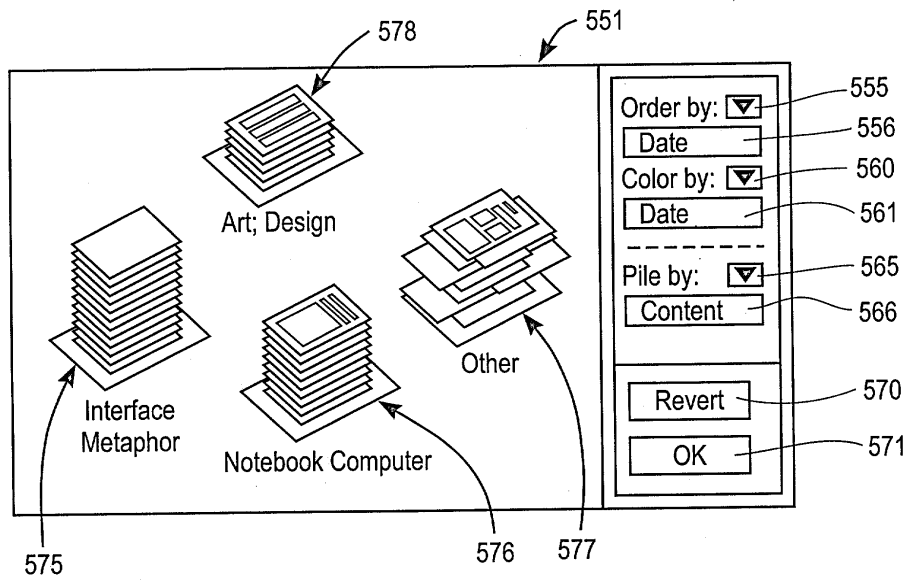

FIG. 13b

09792292.00000000

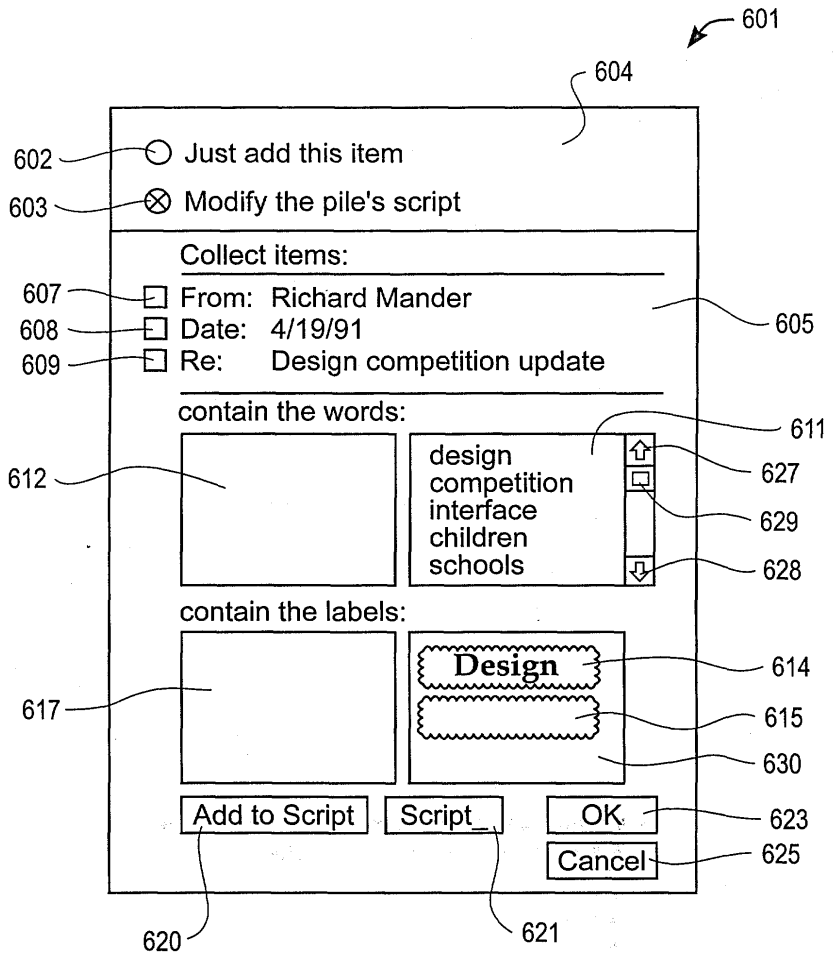

FIG. 14

0979622 051404

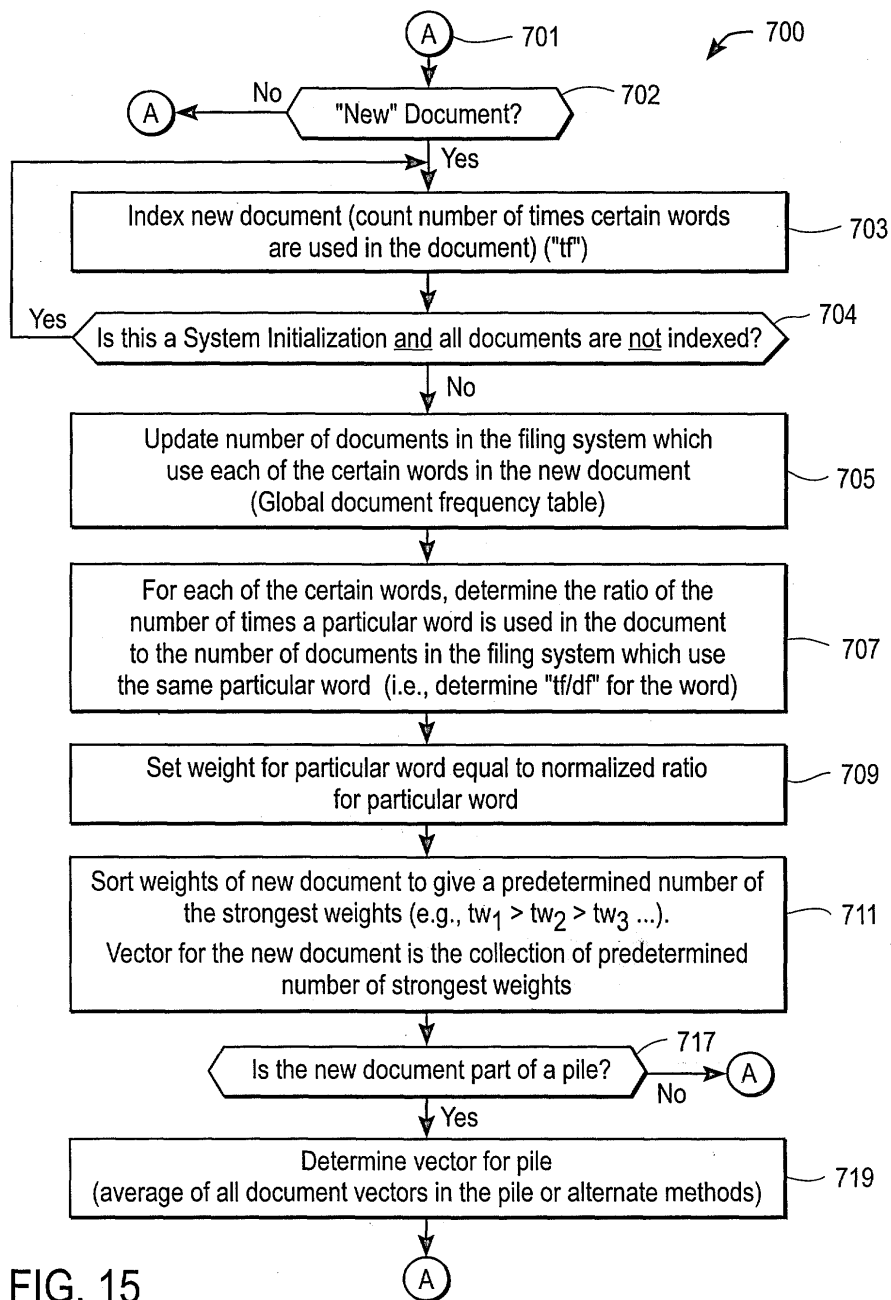

FIG. 15

09796299-051407
101150-26296260

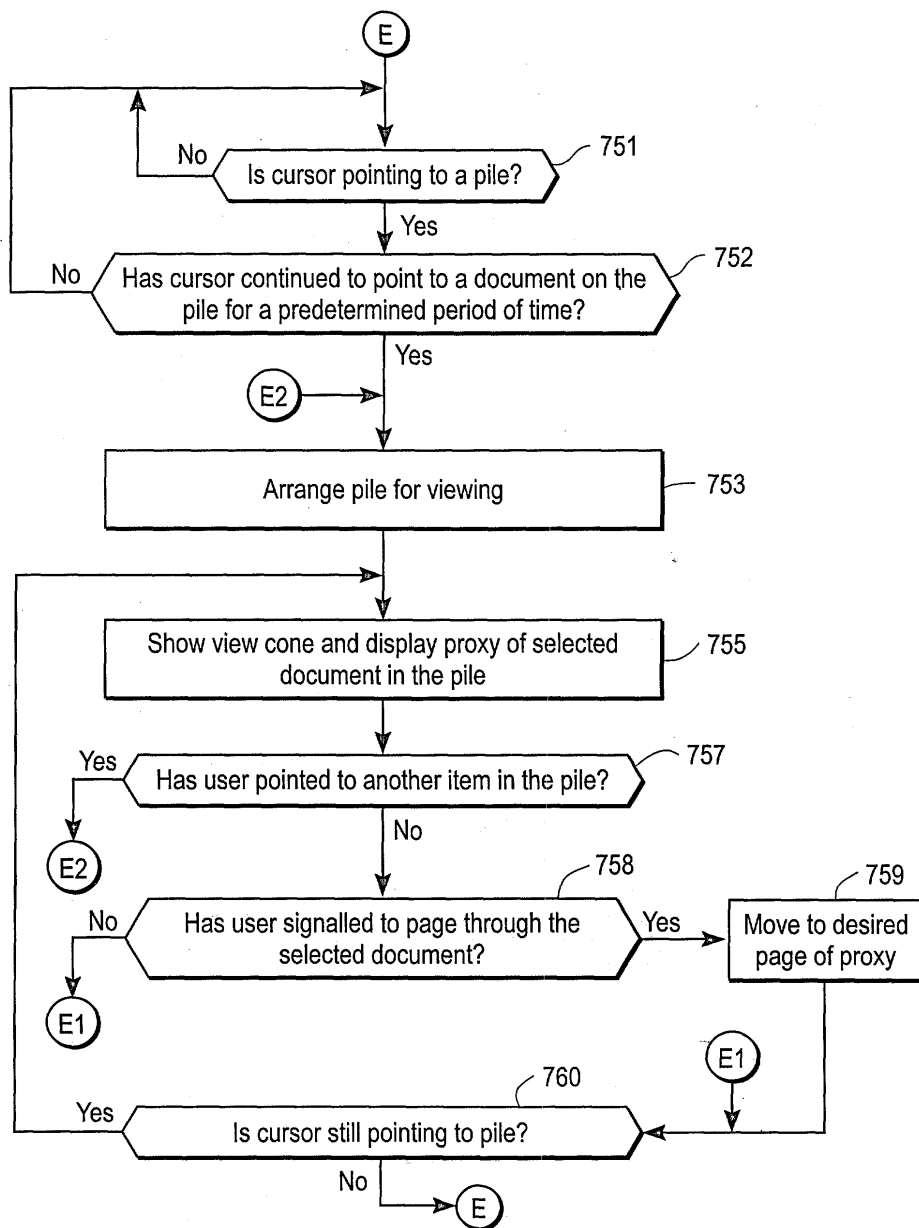

FIG. 16

00796292 054404
FOI/TSO 26296260

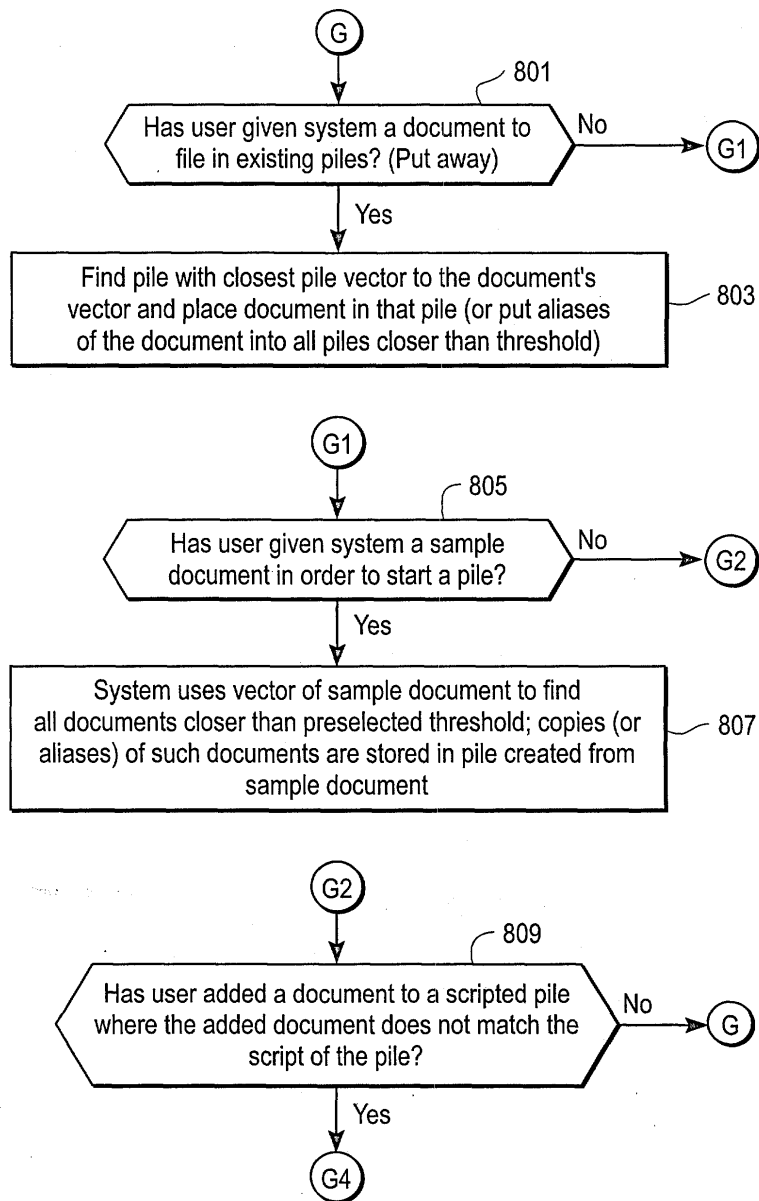

FIG. 17

079622 054401
104150 2629660

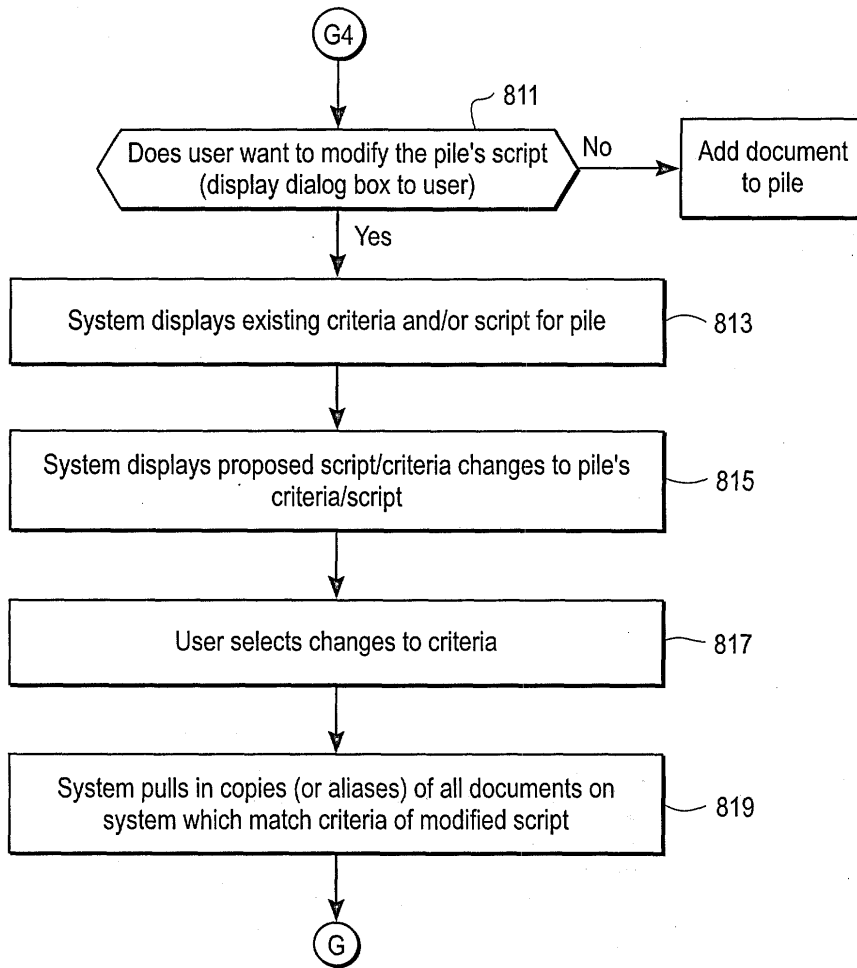

FIG. 17 Continued

00796292-051404

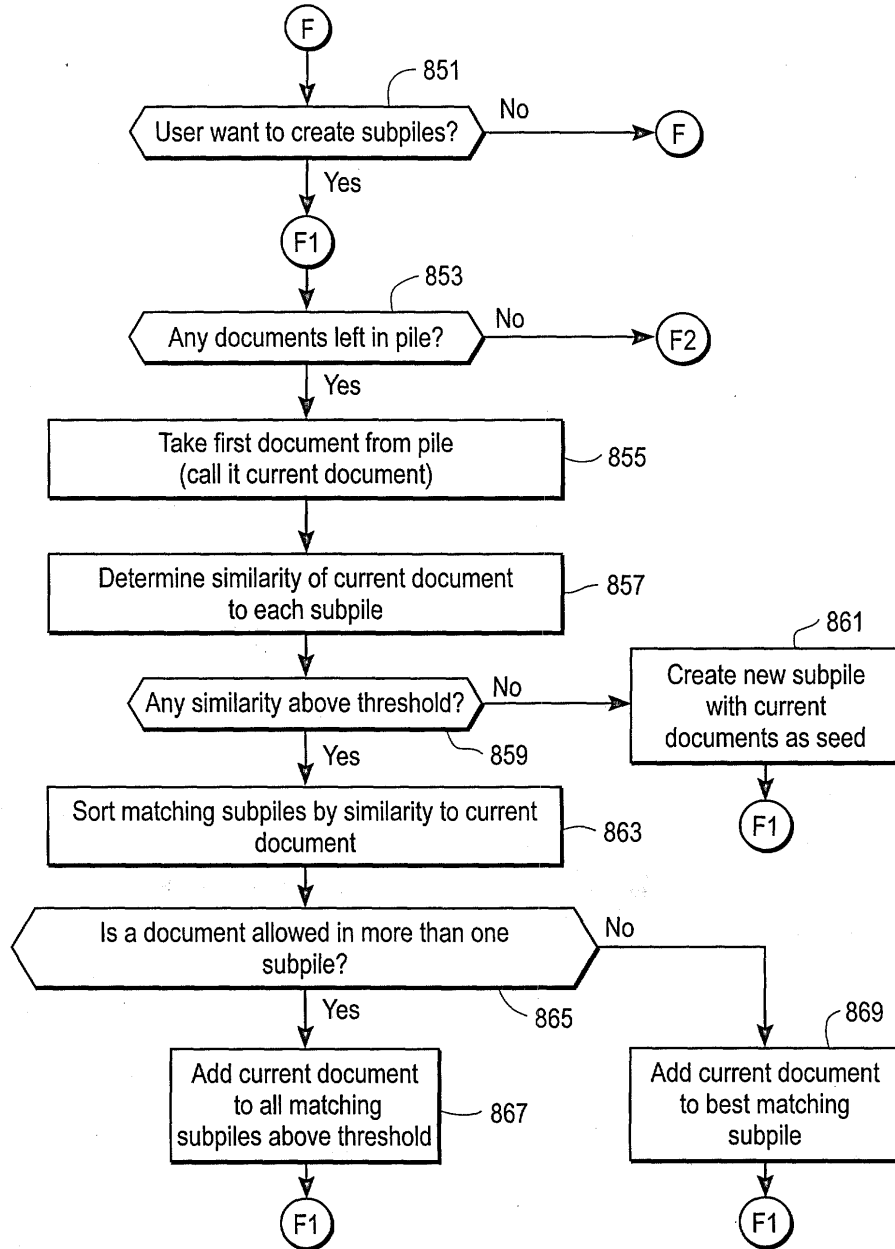

FIG. 18a

00750 2626460

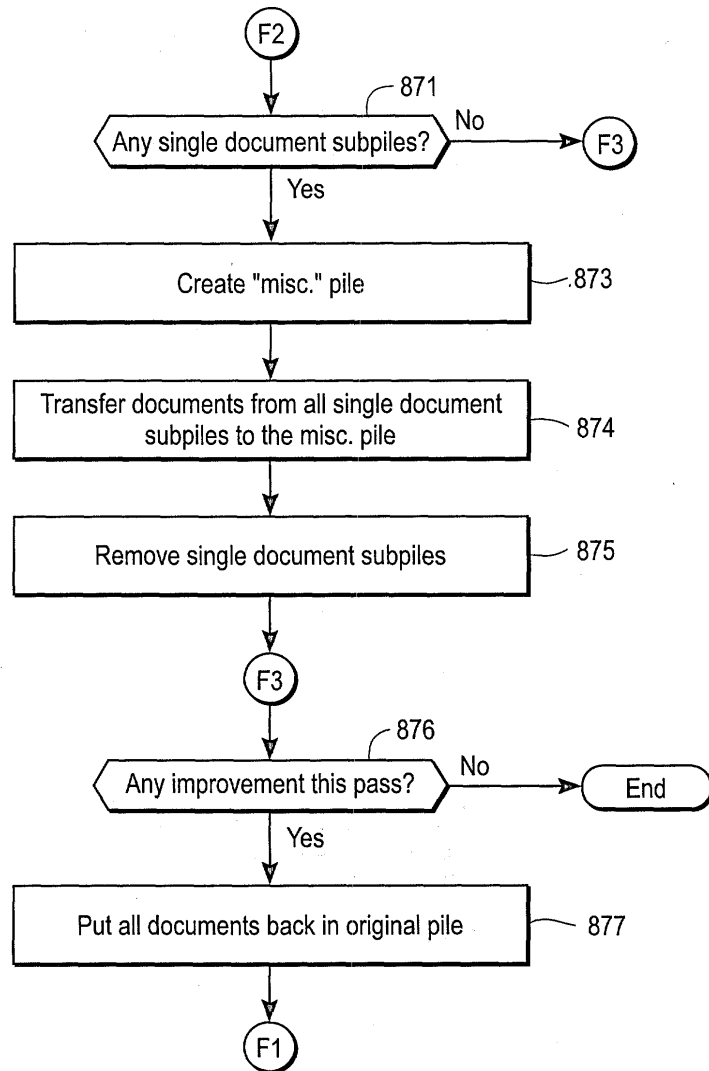

FIG. 18a Continued

104150 26296760

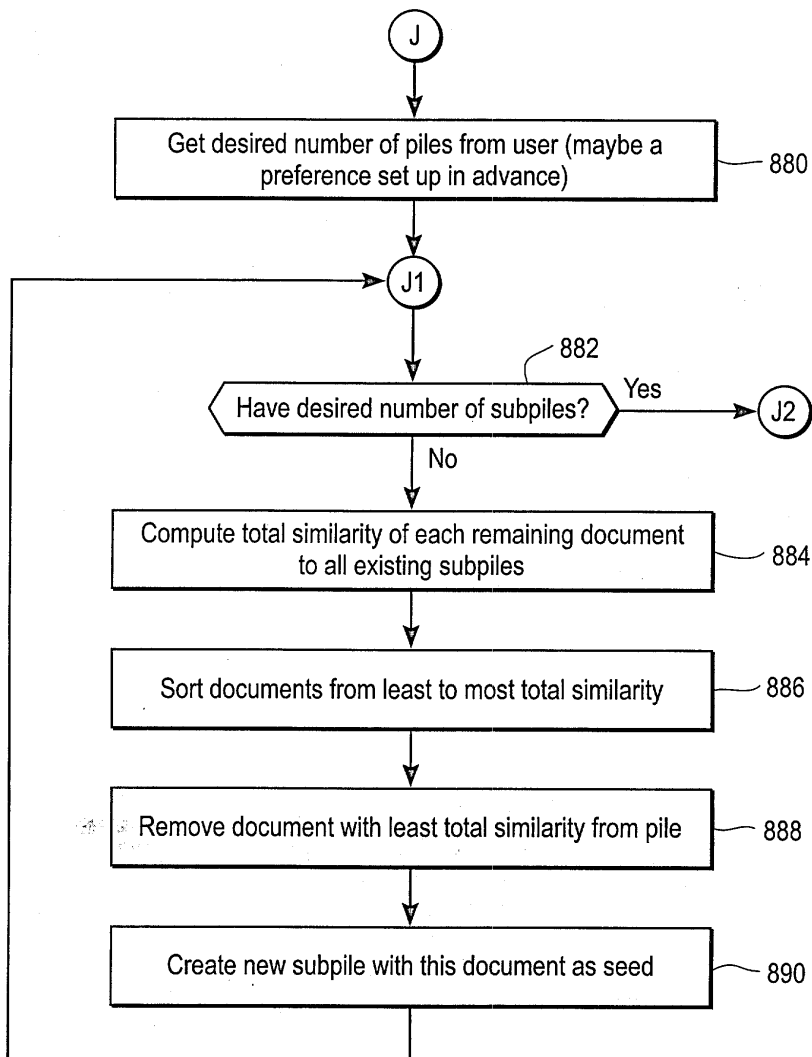

FIG. 18b

09796293 05444
FH50 26266/60

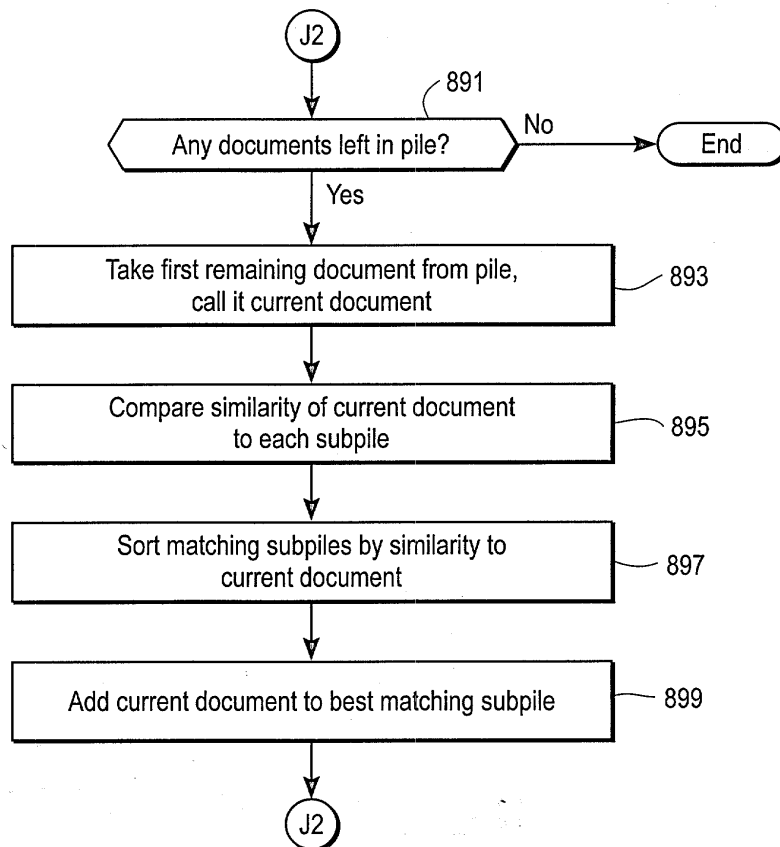

FIG. 18b Continued

101150 26296760

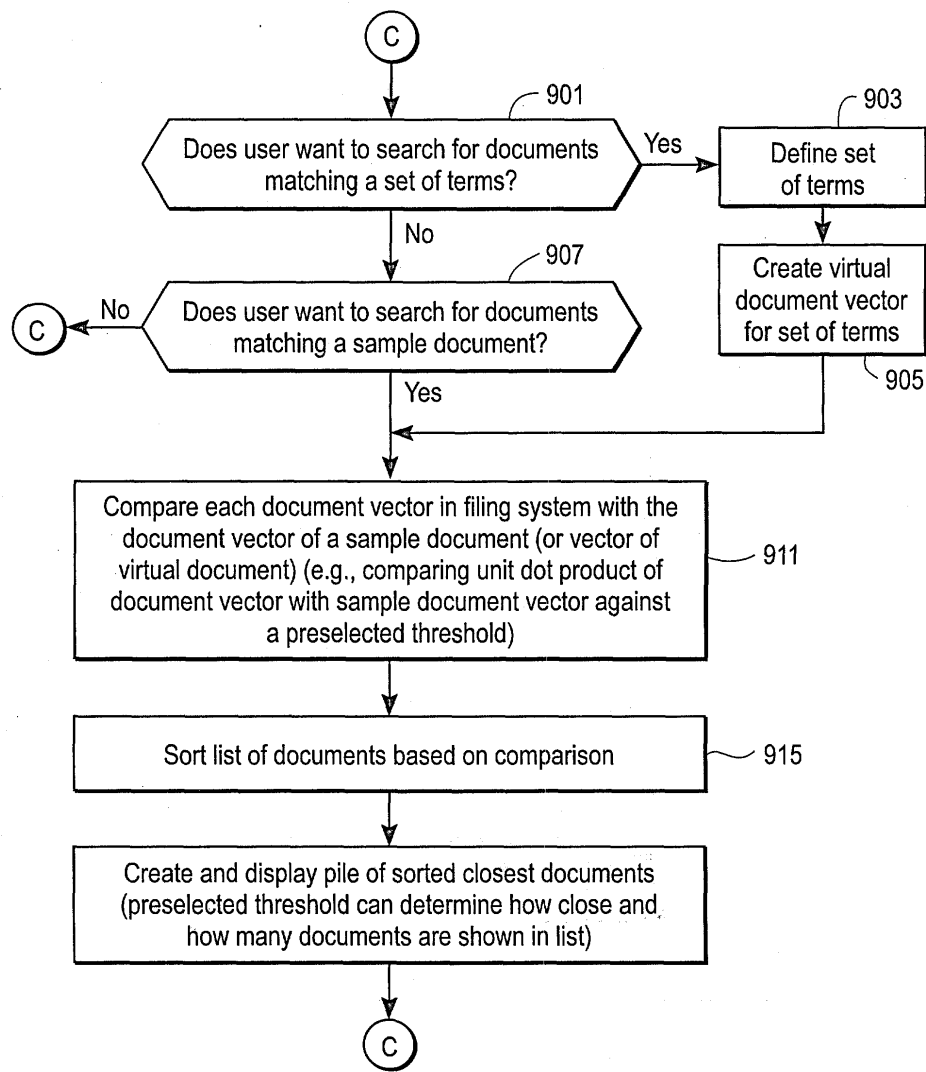

FIG. 19

0979622 051401

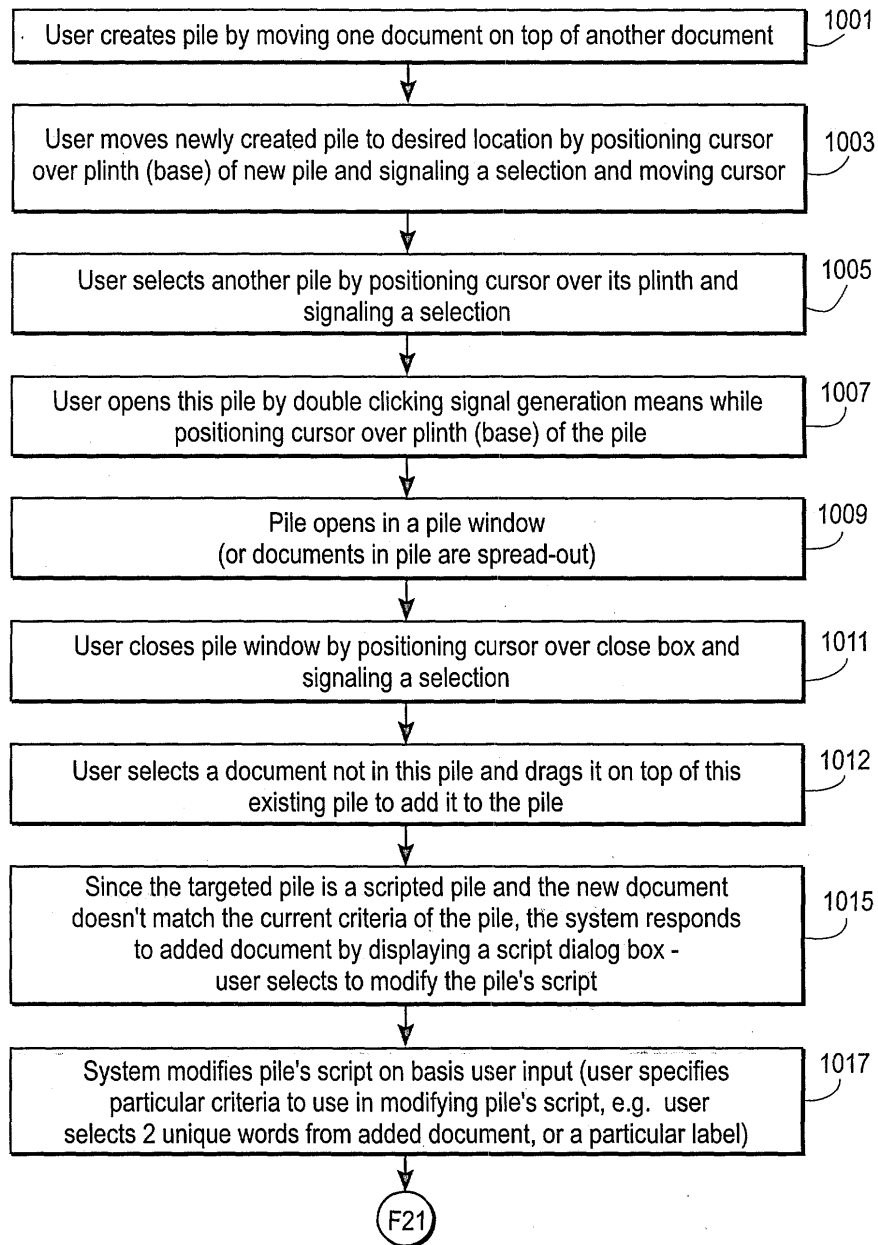

FIG. 21

09796292-054404
104150-26296260

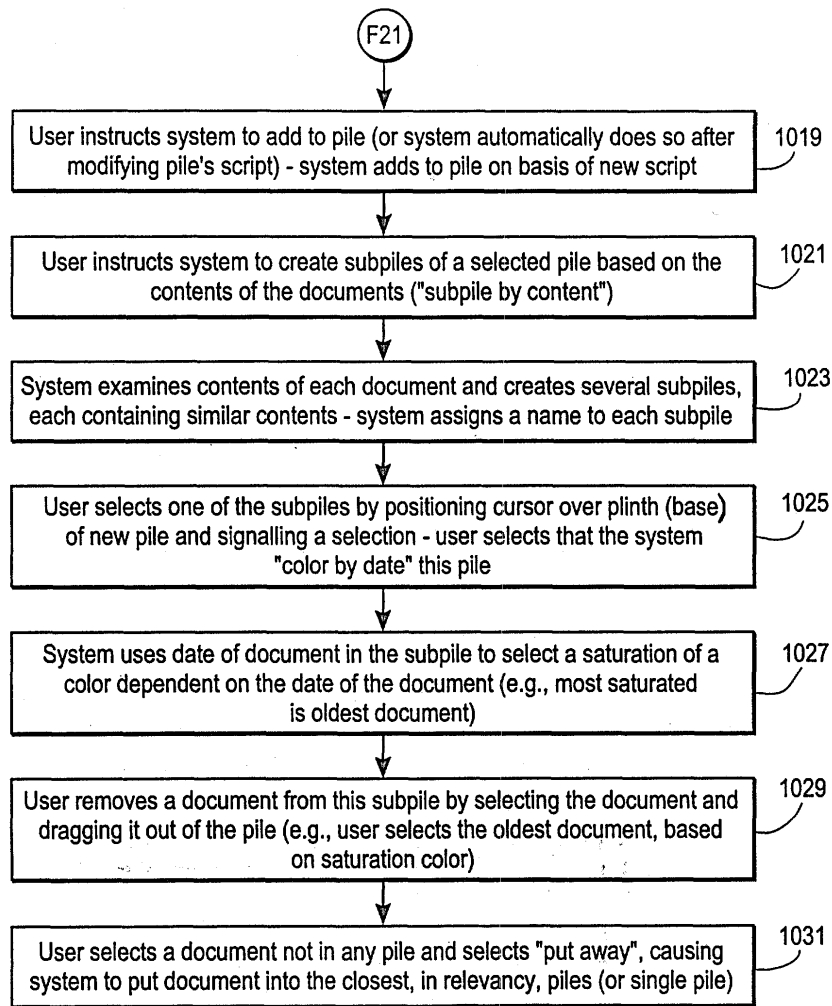

FIG. 21 Continued

FIG. 22a

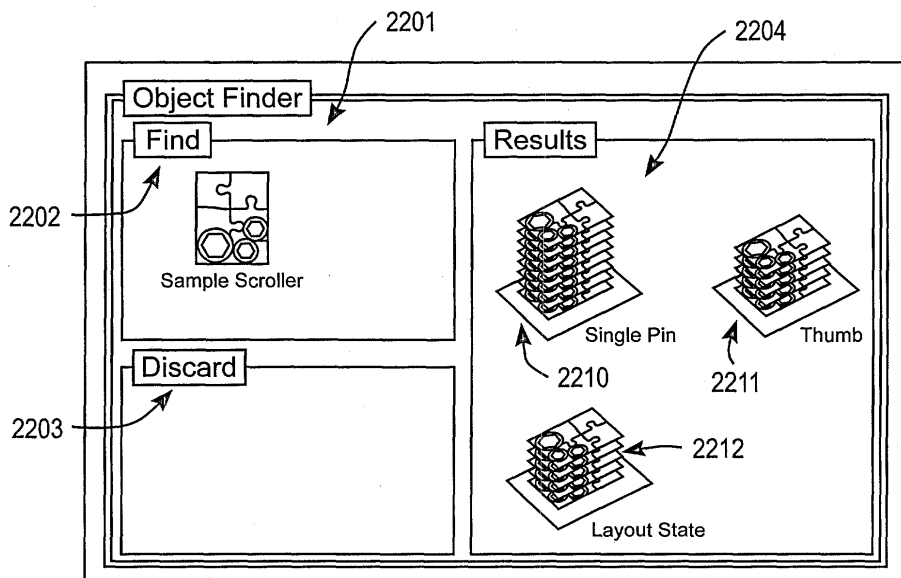

FIG. 22a

101 FH 197 APMW0026041

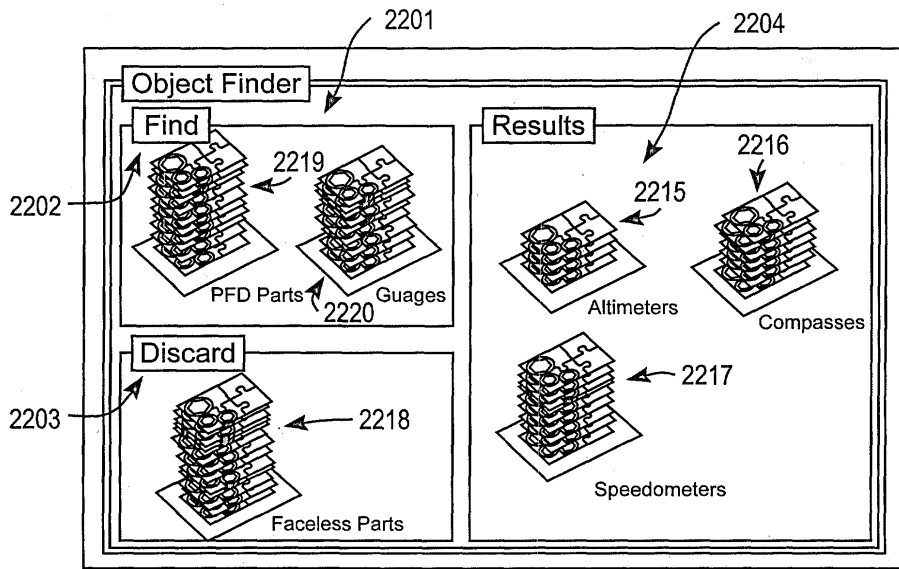

FIG. 22b

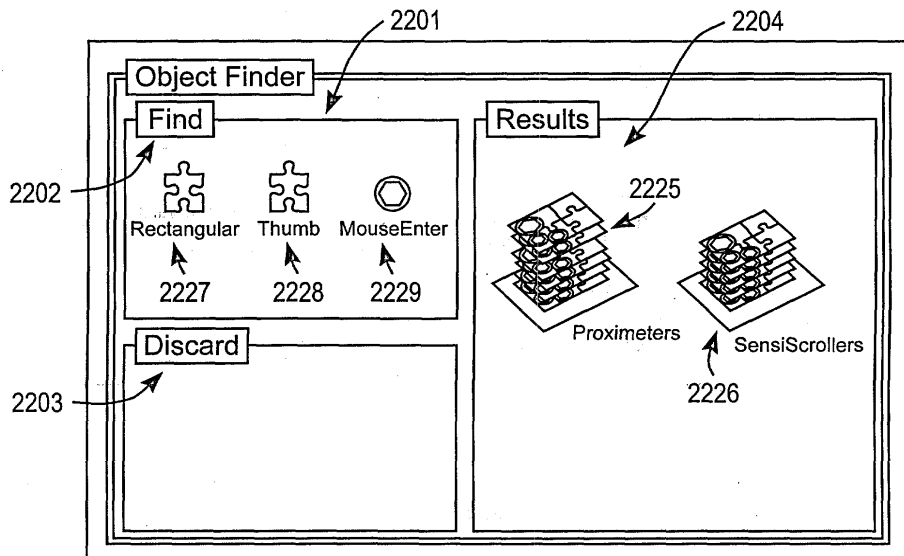

FIG. 22c

101FH198 2629642

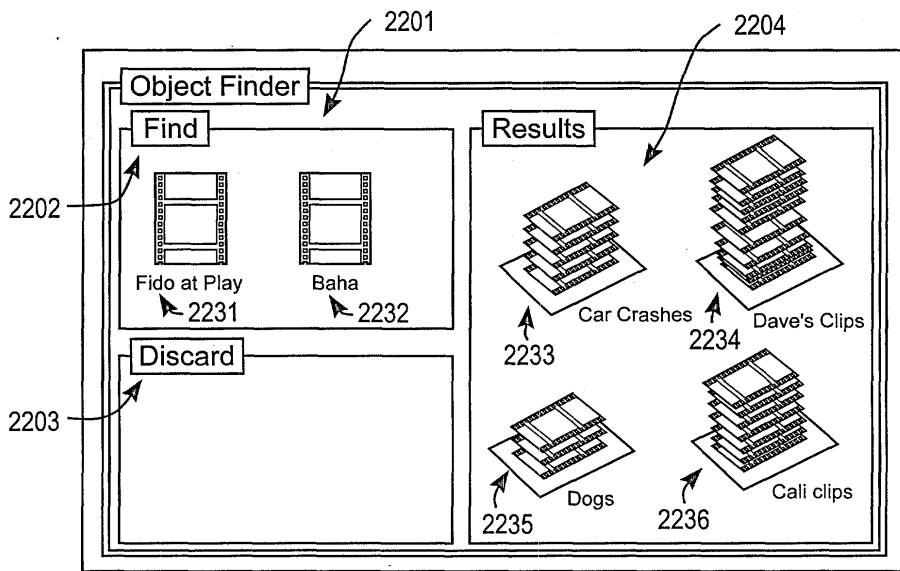

FIG. 22d

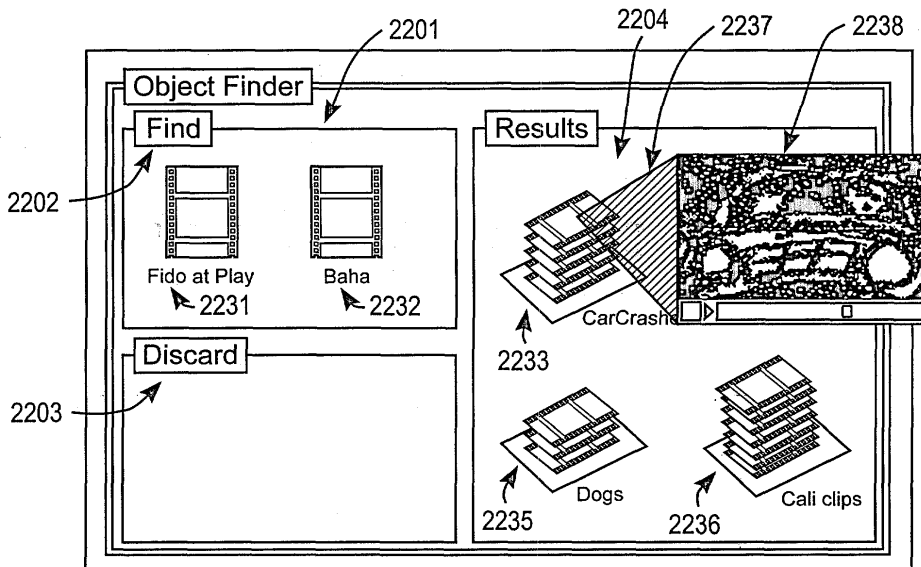

FIG. 22e

09750232-022704

3 displaying a graphical iconic representation of a collection of said first plurality of
4 documents;
5 displaying a first indicia of a first document of said collection by selecting a first
6 position from said graphical iconic representation, wherein said first
7 position on said graphical iconic representation is capable of being at any
8 one of a plurality of locations on said graphical iconic representation and
9 wherein said selecting from said graphical iconic representation comprises
10 positioning a cursor on said graphical iconic representation; and
11 displaying in series a second indicia of a second document and a third indicia of a
12 third document by positioning said cursor first on a second position on said
13 graphical iconic representation next on a third position on said graphical
14 iconic representation.

15

16 ²74. (New) A method as in claim ¹73 wherein said indicia is displayed adjacent to said
17 graphical iconic representation of said collection.

18

19 ³75. (New) A method as in claim ¹73 wherein during said displaying in series said
20 second indicia and said third indicia, said graphical iconic representation is concurrently
21 displayed.

22

23 ⁴76. (New) A method as in claim ²75 wherein said second indicia is displayed adjacent to
24 said graphical iconic representation and said third indicia is displayed adjacent to said
25 graphical iconic representation.

26

27 ⁵77. (New) An apparatus for organizing and viewing information in a computer filing
28 system having a display device and a first plurality of documents, said apparatus
29 comprising:

A