

EXHIBIT A



US007441196B2

(12) **United States Patent**
Gottfurcht et al.

(10) **Patent No.:** **US 7,441,196 B2**
(45) **Date of Patent:** ***Oct. 21, 2008**

(54) **APPARATUS AND METHOD OF MANIPULATING A REGION ON A WIRELESS DEVICE SCREEN FOR VIEWING, ZOOMING AND SCROLLING INTERNET CONTENT**

(58) **Field of Classification Search** 715/700, 715/733-740, 760
See application file for complete search history.

(75) **Inventors:** **Elliot A. Gottfurcht**, Pacific Palisades, CA (US); **Grant E. Gottfurcht**, Pacific Palisades, CA (US); **Albert-Michel C. Long**, Irvine, CA (US)

(56) **References Cited**

U.S. PATENT DOCUMENTS

3,586,771 A 6/1971 Hamburger
4,650,977 A 3/1987 Couch
4,706,121 A 11/1987 Young
4,992,940 A 2/1991 Dworkin

(73) **Assignees:** **Elliot Gottfurcht**, Pacific Palisades, CA (US); **Marlo Longstreet 2003 Irrevocable Trust**, Pacific Palisades, CA (US); **Grant Gottfurcht 2003 Irrevocable Trust**, Pacific Palisades, CA (US)

(Continued)

FOREIGN PATENT DOCUMENTS

CA 2001263 4/1990

(*) **Notice:** Subject to any disclaimer, the term of this patent is extended or adjusted under 35 U.S.C. 154(b) by 0 days.

(Continued)

OTHER PUBLICATIONS

Chieko Asakawa, "User Interface of a Home Page Reader," Apr. 15, 1998, 8 pages, Assets '98, Marina del Rey, California.

(21) **Appl. No.:** **11/373,324**

(Continued)

(22) **Filed:** **Mar. 13, 2006**

Primary Examiner—Simon Ke

(65) **Prior Publication Data**

(74) *Attorney, Agent, or Firm*—SoCal IP Law Group LLP; Steven C. Sereboff; John E. Gunther

US 2006/0212811 A1 Sep. 21, 2006

(57) **ABSTRACT**

Related U.S. Application Data

(63) Continuation of application No. 09/518,015, filed on Mar. 3, 2000, now Pat. No. 7,020,845, which is a continuation-in-part of application No. 09/440,214, filed on Nov. 15, 1999, now Pat. No. 6,600,497.

A method and apparatus of simplified navigation. A web page is provided having a link to a sister site. The sister site facilitates simplified navigation. Pages from the sister site are served responsive to actuation of the sister site link. In one embodiment, the sister site includes matrix pages to permit matrix navigation.

(51) **Int. Cl.**
G06F 3/00 (2006.01)

(52) **U.S. Cl.** **715/740; 715/730; 715/760**

76 Claims, 28 Drawing Sheets

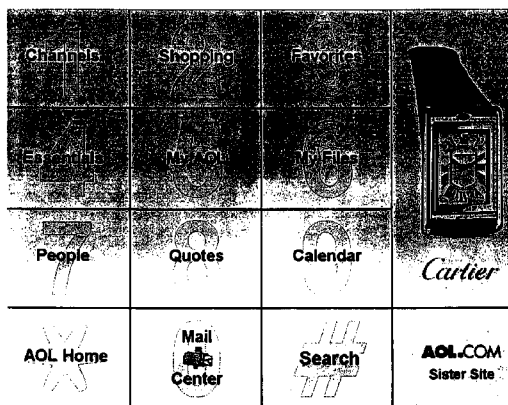

U.S. PATENT DOCUMENTS					
5,041,312	A	8/1991 Swartz	6,094,156	A	7/2000 Henty
5,064,999	A	11/1991 Okamoto et al.	6,101,473	A	8/2000 Scott et al.
5,119,188	A	6/1992 McCalley et al.	6,112,186	A	8/2000 Bergh et al.
5,236,199	A	8/1993 Thompson	6,129,274	A	10/2000 Suzuki
5,321,749	A	6/1994 Virga	6,138,107	A	10/2000 Elgamal
5,353,016	A	10/1994 Kurita et al.	6,142,371	A	11/2000 Oneda
5,410,326	A	4/1995 Goldstein	6,151,050	A	11/2000 Hosono et al.
5,479,268	A	12/1995 Young et al.	6,151,059	A	11/2000 Schein et al.
5,532,735	A	7/1996 Blahut et al.	6,151,596	A	11/2000 Hosomi
5,553,242	A	9/1996 Russell et al.	6,151,630	A	11/2000 Williams
5,559,548	A	9/1996 Davis et al.	6,154,205	A	11/2000 Carroll et al.
5,598,523	A	1/1997 Fujita	6,160,552	A	12/2000 Wilsher et al.
5,602,596	A	2/1997 Claussen et al.	6,167,382	A	12/2000 Sparks et al.
5,617,570	A	4/1997 Russell et al.	6,172,677	B1	1/2001 Stautner et al.
5,625,781	A	4/1997 Cline et al.	6,177,936	B1	1/2001 Cragun
5,710,887	A	1/1998 Chelliah et al.	6,193,152	B1	2/2001 Fernando et al.
5,727,129	A	3/1998 Barrett et al.	6,198,481	B1	3/2001 Urano et al.
5,734,719	A	3/1998 Tsevdos et al.	6,199,050	B1	3/2001 Alaia et al.
5,758,126	A	5/1998 Daniels et al.	6,199,077	B1	3/2001 Inala et al.
5,794,210	A	8/1998 Goldhaber et al.	6,199,098	B1	3/2001 Jones et al.
5,796,252	A	8/1998 Kleinberg et al.	6,205,432	B1	3/2001 Gabbard et al.
5,801,702	A	9/1998 Dolan et al.	6,205,582	B1	3/2001 Hoarty
5,809,204	A	9/1998 Young et al.	6,211,878	B1	4/2001 Cheng et al.
5,819,220	A	10/1998 Sarukkai et al.	6,212,265	B1	4/2001 Duphorne
5,822,014	A	10/1998 Steyer et al.	6,223,215	B1	4/2001 Hunt et al.
5,828,839	A	10/1998 Moncreiff	6,226,623	B1	5/2001 Schein et al.
5,832,208	A	11/1998 Chen et al.	6,226,642	B1	5/2001 Beranek et al.
5,832,459	A	11/1998 Cameron et al.	6,229,540	B1	5/2001 Tonelli et al.
5,838,314	A	11/1998 Neel et al.	6,237,030	B1	5/2001 Adams et al.
5,848,396	A	12/1998 Gerace	6,243,093	B1	6/2001 Czerwinski et al.
5,851,149	A	12/1998 Xidos et al.	6,253,189	B1	6/2001 Feezell et al.
5,874,906	A	2/1999 Willner et al.	6,260,192	B1	7/2001 Rosin et al.
5,878,222	A	3/1999 Harrison	6,266,060	B1	7/2001 Roth
5,890,175	A	3/1999 Wong et al.	6,269,343	B1	7/2001 Pallakoff
5,893,064	A	4/1999 Kudirka et al.	6,269,361	B1	7/2001 Davis et al.
5,895,454	A	4/1999 Harrington	6,269,403	B1	7/2001 Anders
5,896,133	A	4/1999 Lynch et al.	6,271,832	B1	8/2001 Kamaeguchi et al.
5,900,905	A	5/1999 Shoff et al.	6,282,516	B1	8/2001 Giuliani
5,902,353	A	5/1999 Reber et al.	6,285,357	B1	9/2001 Kushiro et al.
5,903,729	A	5/1999 Reber et al.	6,285,987	B1	9/2001 Roth et al.
5,911,145	A *	6/1999 Arora et al. 715/514	6,286,017	B1	9/2001 Egilsson
5,918,014	A	6/1999 Robinson	6,286,043	B1	9/2001 Cuomo et al.
5,918,213	A	6/1999 Bernard et al.	6,288,716	B1	9/2001 Humpleman et al.
5,925,103	A	7/1999 Magallanes et al.	6,292,779	B1	9/2001 Wilson et al.
5,931,901	A	8/1999 Wolfe et al.	6,292,782	B1	9/2001 Weideman
5,935,002	A	8/1999 Falciglia	6,292,786	B1	9/2001 Deaton et al.
5,946,381	A	8/1999 Danne et al.	6,292,809	B1 *	9/2001 Edelman 715/503
5,956,681	A	9/1999 Yamakita	6,295,057	B1	9/2001 Rosin et al.
5,956,693	A	9/1999 Geerlings	6,298,330	B1	10/2001 Gardenswartz et al.
5,958,012	A	9/1999 Battat et al.	6,300,947	B1 *	10/2001 Kanevsky 715/866
5,960,411	A	9/1999 Hartman et al.	6,301,566	B1	10/2001 Costello
5,961,593	A	10/1999 Gabber et al.	6,312,336	B1	11/2001 Handelman et al.
5,978,381	A	11/1999 Perlman et al.	6,314,406	B1	11/2001 O'Hagan et al.
5,990,927	A	11/1999 Hendricks et al.	6,317,706	B1	11/2001 Saib
6,002,853	A	12/1999 de Hond	6,330,005	B1	12/2001 Tonelli et al.
6,005,562	A	12/1999 Shiga et al.	6,330,543	B1	12/2001 Kepecs
6,005,631	A	12/1999 Anderson et al.	6,333,753	B1	12/2001 Hinckley
6,006,257	A	12/1999 Slezak	6,334,108	B1	12/2001 Deaton et al.
6,012,049	A	1/2000 Kawan	6,334,145	B1	12/2001 Adams et al.
6,014,502	A *	1/2000 Moraes 709/219	6,336,131	B1	1/2002 Wolfe et al.
6,018,372	A	1/2000 Etheredge	6,337,715	B1	1/2002 Inagaki et al.
6,025,837	A	2/2000 Matthews, III et al.	6,345,279	B1	2/2002 Li et al.
6,028,600	A	2/2000 Rosin et al.	6,356,905	B1	3/2002 Gershman et al.
6,031,537	A	2/2000 Hugh	6,381,583	B1	4/2002 Kenney
6,041,312	A	3/2000 Bickerton et al.	6,388,714	B1	5/2002 Schein et al.
6,054,989	A	4/2000 Robertson et al.	6,396,531	B1	5/2002 Gerszberg
6,072,483	A	6/2000 Rosin et al.	6,397,387	B1	5/2002 Rosin et al.
6,072,492	A	6/2000 Schagen et al.	6,401,132	B1	6/2002 Bellwood et al.
6,075,575	A	6/2000 Schein et al.	6,407,779	B1	6/2002 Herz
6,078,866	A	6/2000 Buck et al.	6,411,307	B1	6/2002 Rosin et al.
6,091,417	A	7/2000 Lefkowitz	6,411,337	B2	6/2002 Cove et al.
			6,415,270	B1	7/2002 Rackson et al.
			6,417,873	B1	7/2002 Fletcher et al.

6,418,441 B1	7/2002	Call	2002/0042914 A1	4/2002	Walker et al.
6,421,066 B1	7/2002	Sivan	2002/0042921 A1	4/2002	Ellis
6,421,071 B1	7/2002	Harrison	2002/0049631 A1	4/2002	Williams
6,421,724 B1	7/2002	Nickerson et al.	2002/0056098 A1	5/2002	White
6,438,540 B2	8/2002	Nasr et al.	2002/0059590 A1	5/2002	Kitsukawa et al.
6,445,398 B1	9/2002	Gerba et al.	2002/0067376 A1	6/2002	Martin et al.
6,460,181 B1	10/2002	Donnelly	2002/0077177 A1	6/2002	Elliott
6,476,825 B1	11/2002	Croy	2002/0078006 A1	6/2002	Shteyn
6,477,575 B1	11/2002	Koepfel et al.	2002/0078453 A1	6/2002	Kuo
6,484,149 B1	11/2002	Jammes et al.	2002/0098834 A1	7/2002	Yuen
6,487,189 B1	11/2002	Eldridge et al.	2002/0116292 A1	8/2002	Palatin
6,487,586 B2	11/2002	Ogilvie et al.	2002/0116320 A1	8/2002	Nassiri
6,490,555 B1	12/2002	Yegnanarayanan et al.	2002/0166122 A1	11/2002	Kikinis et al.
6,509,913 B2	1/2003	Martin, Jr. et al.	2003/0046182 A1	3/2003	Hartman
6,516,311 B1	2/2003	Yacoby	2003/0074661 A1	4/2003	Krapf et al.
6,522,342 B1	2/2003	Gagnon et al.	2003/0095525 A1	5/2003	Lavin et al.
6,532,312 B1	3/2003	Corkran	2003/0126607 A1	7/2003	Phillips et al.
6,535,888 B1	3/2003	Vijayan et al.	2003/0140017 A1	7/2003	Patton et al.
6,570,582 B1	5/2003	Sciammarella et al.	2003/0146940 A1	8/2003	Ellis et al.
6,571,279 B1	5/2003	Herz	2003/0149628 A1	8/2003	Abbosh et al.
6,583,800 B1 *	6/2003	Ridgley et al. 715/854	2003/0182195 A1	9/2003	Kumar
6,606,103 B1	8/2003	Hamlet et al.	2004/0003412 A1	1/2004	Halbert
6,606,280 B1	8/2003	Knittel	2004/0098747 A1	5/2004	Kay et al.
6,606,347 B1	8/2003	Ishii	2004/0103439 A1	5/2004	Macrae et al.
6,608,633 B1	8/2003	Sciammarella et al.	2004/0117831 A1	6/2004	Ellis et al.
6,615,247 B1	9/2003	Murphy	2004/0128137 A1	7/2004	Bush et al.
6,615,248 B1	9/2003	Smith	2004/0133848 A1	7/2004	Hunt et al.
6,618,039 B1	9/2003	Grant et al.	2004/0148625 A1	7/2004	Eldering et al.
6,631,523 B1	10/2003	Matthews, III et al.	2004/0204116 A1	10/2004	Ben-Efraim et al.
6,636,246 B1	10/2003	Gallo et al.	2004/0210824 A1	10/2004	Shoff et al.
6,647,373 B1	11/2003	Carlton-Foss	2004/0260689 A1	12/2004	Colace et al.
6,662,224 B1 *	12/2003	Angwin et al. 709/224	2005/0010949 A1	1/2005	Ward et al.
6,680,714 B2	1/2004	Wilmore	2005/0025550 A1	2/2005	McLoone
6,684,062 B1	1/2004	Gosior et al.	2005/0075932 A1	4/2005	Mankoff
6,692,358 B2	2/2004	Lawrence et al.	2005/0086690 A1	4/2005	Gilfix
6,704,727 B1	3/2004	Kravets	2005/0091118 A1	4/2005	Fano
6,711,552 B1	3/2004	Kay	2005/0160458 A1	7/2005	Baumgartner
6,714,534 B1	3/2004	Gerszberg et al.	2005/0234895 A1	10/2005	Kramer
6,728,731 B2	4/2004	Sarukkai et al.	2005/0246231 A1	11/2005	Shkedi
6,769,989 B2	8/2004	Smith et al.	2006/0155598 A1	7/2006	Spurr et al.
6,804,786 B1	10/2004	Chamley et al.	2006/0224987 A1	10/2006	Caffarelli
6,826,572 B2	11/2004	Colace et al.	2007/0008332 A1	1/2007	Smith
6,829,646 B1	12/2004	Philyaw et al.			
6,857,102 B1 *	2/2005	Bickmore et al. 715/501.1			
6,868,525 B1	3/2005	Szabo			
6,907,556 B2	6/2005	McElfresh et al.			
6,925,595 B1	8/2005	Whitledge et al.			
6,928,610 B2 *	8/2005	Brintzenhofe et al. 715/517			
6,938,073 B1	8/2005	Mendhekar et al.			
6,973,669 B2	12/2005	Daniels			
6,978,263 B2	12/2005	Soulanille			
7,013,435 B2	3/2006	Gallo et al.			
7,020,845 B1 *	3/2006	Gottfurcht et al. 715/853			
7,051,281 B1	5/2006	Yokota			
7,174,512 B2	2/2007	Martin et al.			
7,293,276 B2	11/2007	Phillips et al.			
7,383,515 B2	6/2008	Bardon et al.			
2001/0003845 A1	6/2001	Tsukamoto et al.			
2001/0012286 A1	8/2001	Huna et al.			
2001/0016947 A1	8/2001	Nishikawa et al.			
2001/0034647 A1	10/2001	Marks et al.			
2001/0042002 A1	11/2001	Koopersmith			
2001/0044751 A1	11/2001	Pugliese, III et al.			
2001/0049824 A1	12/2001	Baker et al.			
2001/0051903 A1	12/2001	Hansmann et al.			
2002/0007309 A1	1/2002	Reynar			
2002/0010642 A1	1/2002	Go			
2002/0016750 A1	2/2002	Attia			
2002/0029339 A1	3/2002	Rowe			
2002/0032782 A1	3/2002	Rangan et al.			
2002/0035174 A1	3/2002	Alpdemir			
2002/0038256 A1	3/2002	Nguyen			
2002/0038259 A1	3/2002	Bergman et al.			

FOREIGN PATENT DOCUMENTS

EP	1107100 A1	6/2001
WO	WO-01/75678	10/2001
WO	EP-1276318 A1	1/2003

OTHER PUBLICATIONS

Susan Decker, "Google Seeks to Invalidate Rival Overture's Web Search Patent," www.detnews.com, Jun. 20, 2002.

Stephanie Olsen and Gwendolyn Mariano, "Overture Sues Google Over Search Patent," www.news.com, Apr. 5, 2002.

Danny Sullivan, "Overture Files Patent Lawsuit Against Google," searchenginewatch.com, May 6, 2002.

Anon, "Videotron LTEE: Videoway Launches Two New Services: Parental Control and Instant Program Listings," Dec. 13, 1994.

Charles Heinemann, "Going from HTML to XML," Microsoft Corporation, Nov. 5, 1998.

"How to Know When Your Buddies are Online," AOL, 1997.

Written Opinion dated Jun. 6, 2002, issued in PCT/US00/30248.

www.homedepot.com, Feb. 21, 2002, accessed Aug. 17, 2005 via www.archive.org.

Press Release, Delphi's Communiport Integrated Navigation Radio Mapping the Future of Audio, Jan. 7, 2002.

News Release, New York Stock Exchange, Jan. 3, 2002, "Delphi to Spruce Holiday Wish Lists for 2002".

Business Editors, Technology & Marketing Writers, "Marketers Struggle to Achieve ROI on 'Affiliate Marketing' Programs; Dynamic Trade Brings Marketers to Next Level," Business Wire, New York, Jan. 31, 2000, p. 1.

- www.walmart.com, Mar. 31, 2001, accessed Sep. 1, 2005 via www.archive.org.
- Julie Newman and Kenneth A. Kozar, "A Multimedia Solution to Productivity Gridlock: A Re-Engineered Jewelry Appraisal System at Zale Corporation," MIS Quarterly, Minneapolis, Mar. 1994, vol. 18, Issue 1, p. 21.
- Definition of "interface" (n), Microsoft Press Computer Dictionary, 3rd ed. (Redmond WA: Microsoft Press, 1997).
- Business Editors/Hi-Tech Writers, "Paytrust.com Launches Highly Rewarding Affiliate Program," Business Wire, New York, Sep. 15, 1999, p. 1 (recovered from ProQuest database Mar. 4, 2006).
- "Handhelds get better net compatibility," Paul McDougall; Information Week; Oct. 11, 1999, p. 28.
- "IBM Speeding up Web data for sub-PC clients," marc Songini; Network World; Sep. 27, 1999, p. 8.
- "Internet by Proxy"; Amy Helen Johnson; Computerworld; Aug. 30, 1999; 33, 35; p. 66.
- "Riverbed Aims Small"; Aaron Ricadela; Information Week; Jul. 26, 1999; 745; p. 24.
- "Extending the Internet" Steve Zurier; InternetWeek. Manhasset; Jun. 21, 1999, Iss. 770; p. 49.
- "Enterprise resource planning goes mobile" ; Stannie Holt, et al., InfoWorld, Sep. 6, 1999; 21, 36, p. 12.
- "Client-Server Computing in Mobile Environments" Jin Jung; Abdelsalam (SUMI) Helal and Ahmed Elmagarmid; ACM Computing Surveys, vol. 31, No. 2, Jun. 1999.
- "AvantGo server eases handheld access to enterprise applications" Jason Meserve; Network World; Sep. 6, 1999; 16, 36; ABI/Inform Global p. 21.
- "Tougher Web-Site Coding" Jason Levitt; InformationWeek; Mar. 8, 1999; 724, p. 51.
- "New Web Whopper"; Joshua Piven; Computer Technology Review; Sep. 1999; 19, 9; p. 1.
- "Wireless Markup Language as a Framework for Interaction with Mobile Computing Communication Device" Jo Herstad, et al., Proceedings of the First Workshop on Human Computer Interaction with Mobile Devices; <http://www.dcs.gla.ac.uk/johnson/papers/mobile/HCIMD1.html> (66 of of 80) Jun. 7, 2006 7:30:35am.
- "In the Palm of Your Hand"; Kimberly Patch and Eric Smalley; Power Source; WebBusiness Magazine; May 1, 1999.
- "Oasis 1.0 Offers 'Author ONce, View Anywhere' Solution"; Anonymous; Information Today; Mar. 1999, 16, 3; p. 41.
- Telecommunications (A Special Report): The Users—In the Palm of Your Hand: Companies are searching to fit the Web on the screens of hand-held gadgets Lisa Bransten; Sep. 20, 1999; Handheld computers, Internet Access, Series & special reports, Wireless communications.
- "Spyglass Readies Technology Blitz" Michael Kanellos; Computer Reseller News; Dec. 9, 1996; 714; p. 24.
- "Sprint Brings the Power of the Wireless Internet to the Palm of Your Hand With the Introduction of the Sprint PCS Wireless Web—Company Business and Marketing" Edge: Work-Group Computing Report; Aug. 16, 1999.
- "West: A Web Browser for Small Terminals" S. Bjork, et al.; CHI Letters vol. 1, 1 pp. 187-196.
- "Wireless Application Protocol WAP 2.0; Technical White Paper" www.wapforum.org; Jan. 2002 13 pages.
- "New Standard to Bolster Wireless Internet Transactions"; anonymous; Information Week; Oct. 18, 1999; ABI/Form Global, p. 30.
- "WAP Definition"; Amy Helen Johnson; Computerworld; Nov. 1, 1999; 33, 44; ABI/Inform Global; p. 69.
- Remhof, K.; "The Gadgeteer—Palm VII Review"; May 25, 1999; http://www.the-gadgeteer.com/review/palm_vii_review.
- Barnett, S.; "Palm VII"; Pen Computing; http://www.pencomputing.com/palm/Reviews/palm7_main.html.
- Shirriff, K.; "PalmPilot: Tiny Viewer"; <http://www.righto.com/pilot/tv.html>.
- Sorenson, D.; "PC Expo 1999: a Mac perspective"; MacInTouch Special Reports; Jun. 27, 1999; <http://macintouch.com/pcexpo1999.html>.

* cited by examiner

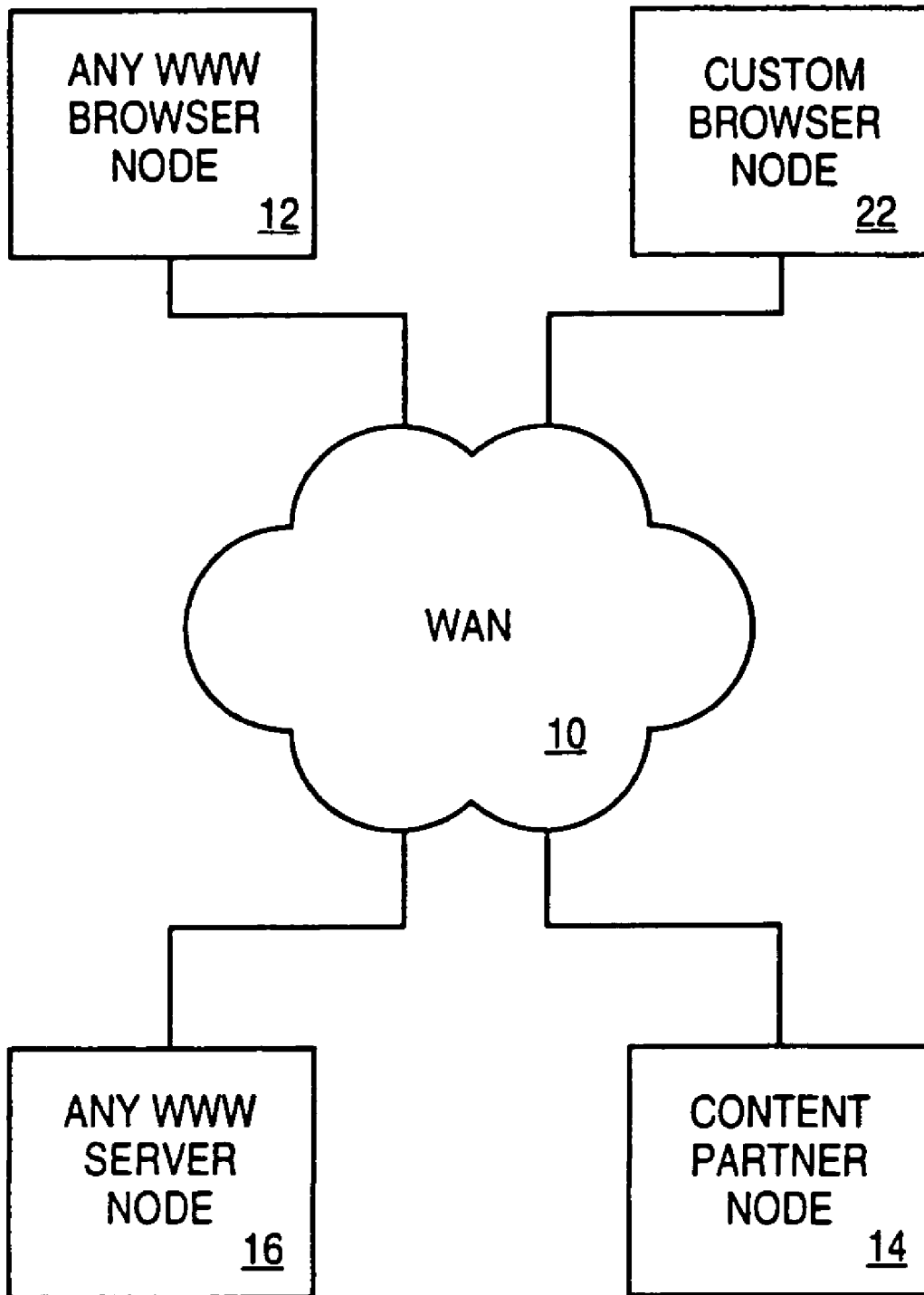

FIG. 1

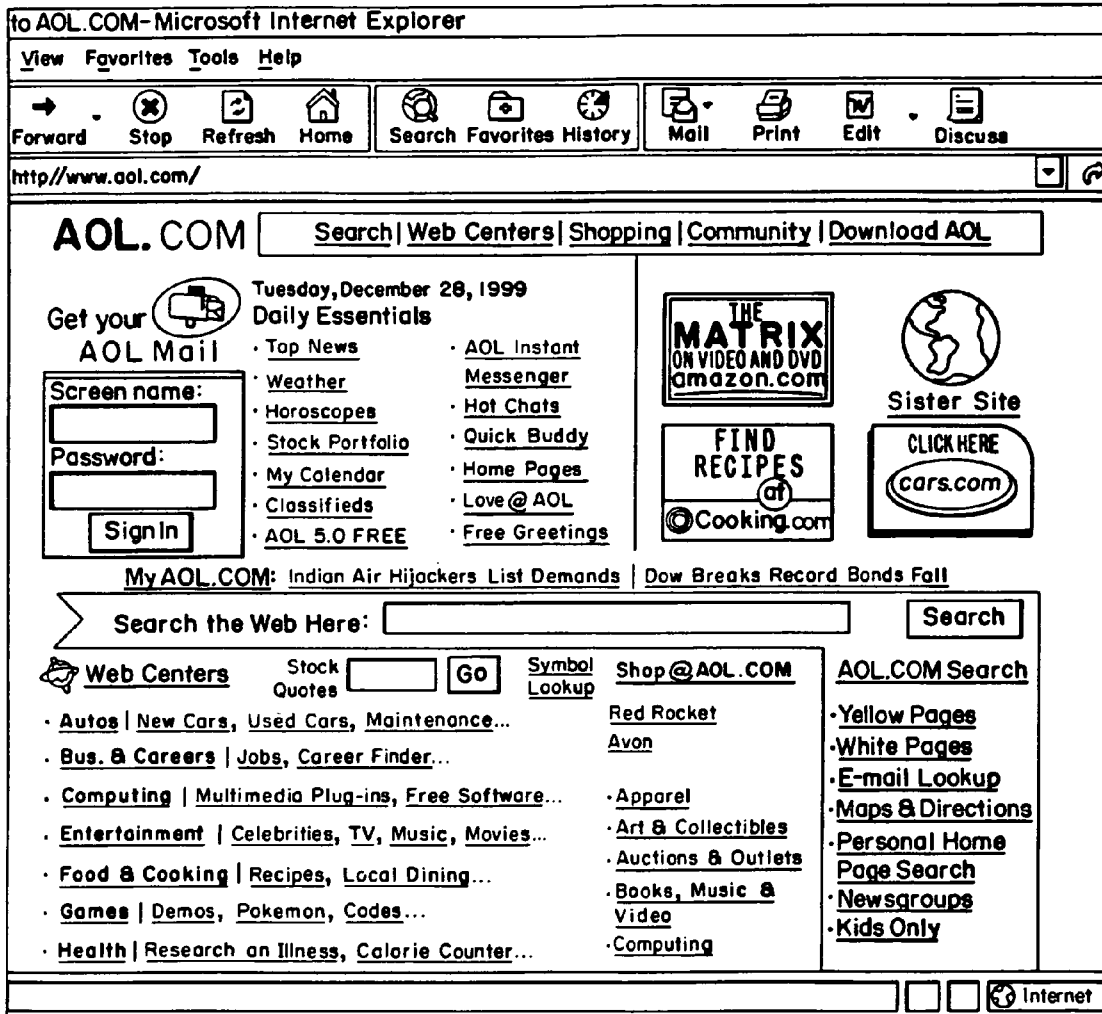

FIG. 2A

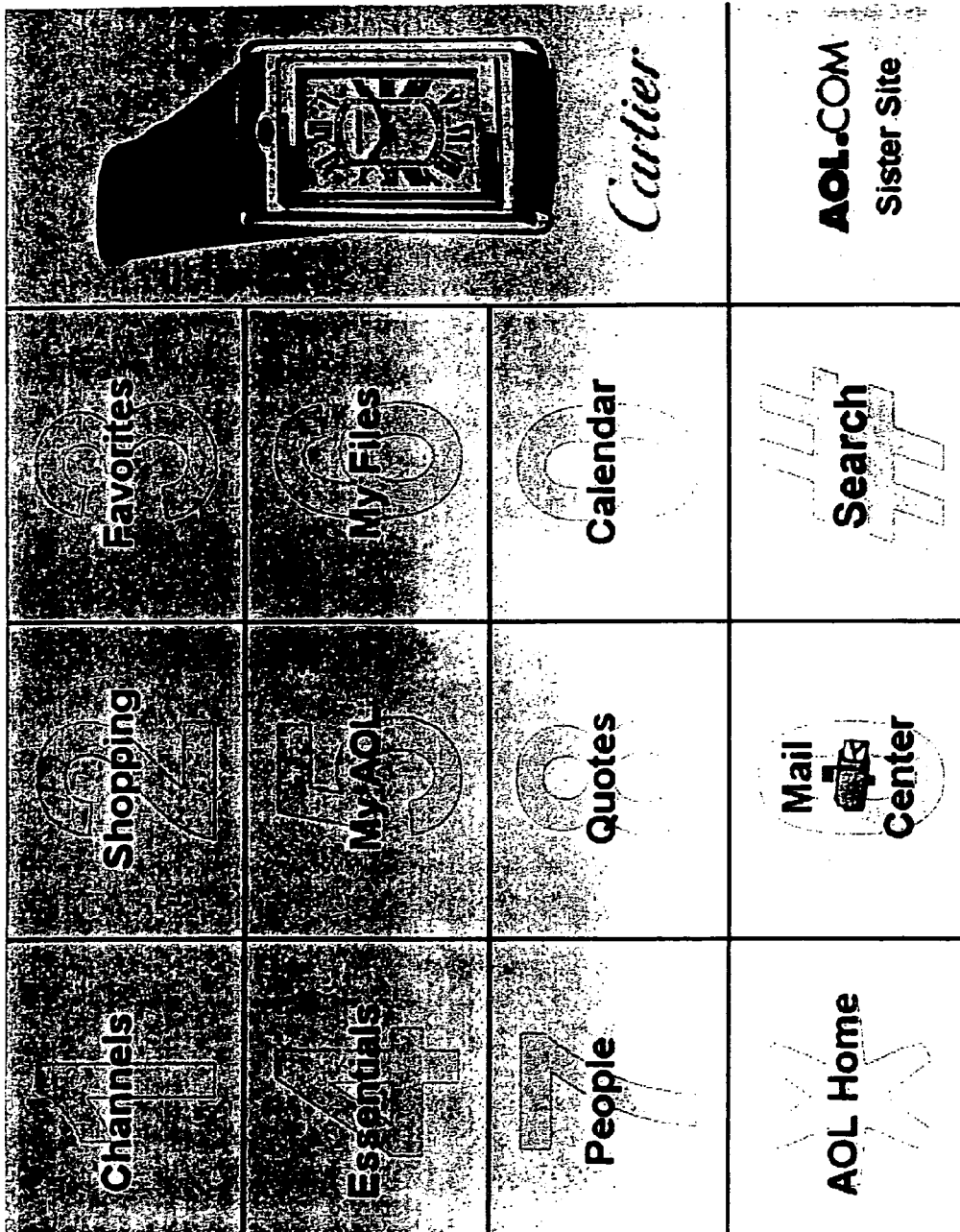

FIG. 2B

Thursday, February 17, 2000

Yahoo!

Page: 1

YAHOO!

What's New

Check Email

Personalize

Help

Yahoo! Mail
free email for life

Free Internet Access

[advanced search](#)

Shopping - Auctions - Yellow Pages - People Search - Maps - Travel - Classifieds - Personals - Games - Chat - Clubs
 Mail - Calendar - Messenger - Companion - My Yahoo! - News - Sports - Weather - TV - Stock Quotes - more...

Yahoo! Shopping - Thousands of stores. Millions of products.

Departments	Stores	Products
· Apparel	· Toys R Us	· Digital cameras
· Bath/Beauty	· Gap	· Pokemon
· Computers	· Vermont Teddy Bear	· MP3 players
· Electronics	· Macy's	· DVD players
· Flowers		
· Food/Drink		
· Music		
· Video/DVD		

In the News

- Clinton urges Congress to back Congo force
- Windows 2000 debut
- NASA releases NEAR asteroid images

[more...](#)

Arts & Humanities
Literature, Photography...

Business & Economy
Companies, Finance, Jobs...

Computers & Internet
Internet, WWW, Software, Games...

Education
College and University, K-12...

Entertainment
Cool Links, Movies, Humor, Music...

Government
Elections, Military, Law, Taxes...

Health
Medicine, Diseases, Drugs, Fitness...

News & Media
Full Coverage, Newspapers, TV...

Recreation & Sports
Sports, Travel, Autos, Outdoors...

Reference
Libraries, Dictionaries, Quotations...

Regional
Countries, Regions, US States...

Science
Animals, Astronomy, Engineering...

Social Science
Archaeology, Economics, Languages...

Society & Culture
People, Environment, Religion...

Marketplace

- Loan Center - auto loans, mortgages, credit reports
- Yahoo! Bill Pay - free 3-month trial
- Yahoo! Autos - buy new and used cars

[more...](#)

Inside Yahoo!

- Yahoo! Outloud - featuring Smash Mouth
- Y! Mobile - Yahoo! on your phone
- Play free Fantasy Auto Racing
- Y! Greetings - free greeting cards

[more...](#)

World Yahoos Europe : Denmark - France - Germany - Italy - Norway - Spain - Sweden - UK & Ireland
 Pacific Rim : Asia - Australia & NZ - China - Chinese - HK - Japan - Korea - Singapore - Taiwan
 Americas : Brazil - Canada - Mexico - Spanish

Yahoo! Get Local LA - NYC - SF Bay - Chicago - more...

Other Autos - Careers - Digital - Entertainment - Greetings - Health - Invites - Local Events - Net Events
 Message Boards - Movies - Music - Real Estate - Small Business - Y! Internet Life - Yahoo!igans!

Yahoo! prefers

[How to Suggest a Site](#) - [Company Info](#) - [Privacy Policy](#) - [Terms of Service](#) - [Contributors](#) - [Openings at Yahoo!](#)

Copyright © 2000 Yahoo! Inc. All rights reserved.
[Copyright Policy](#)

http://www.yahoo.com

FIG. 2C

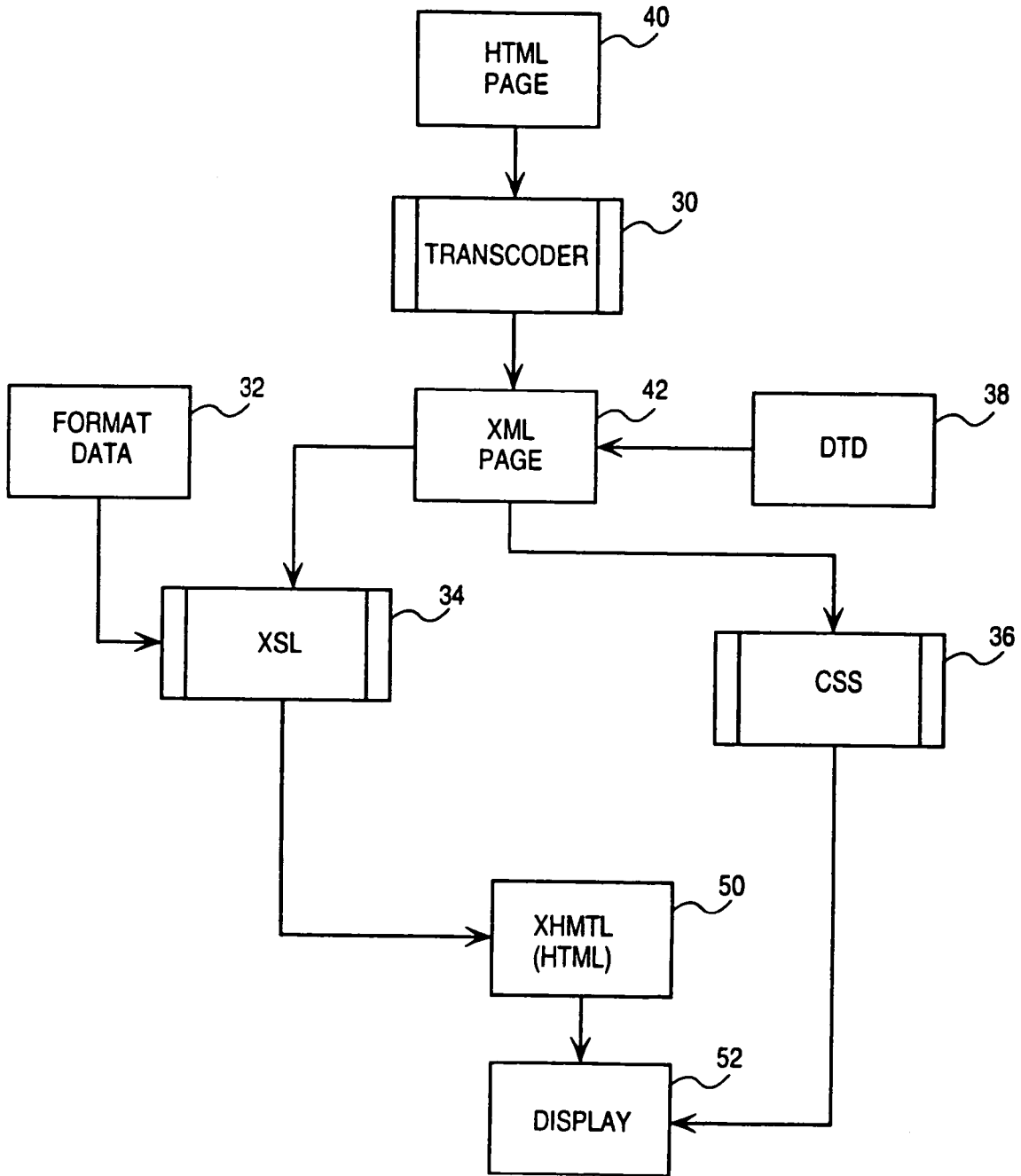

FIG. 3

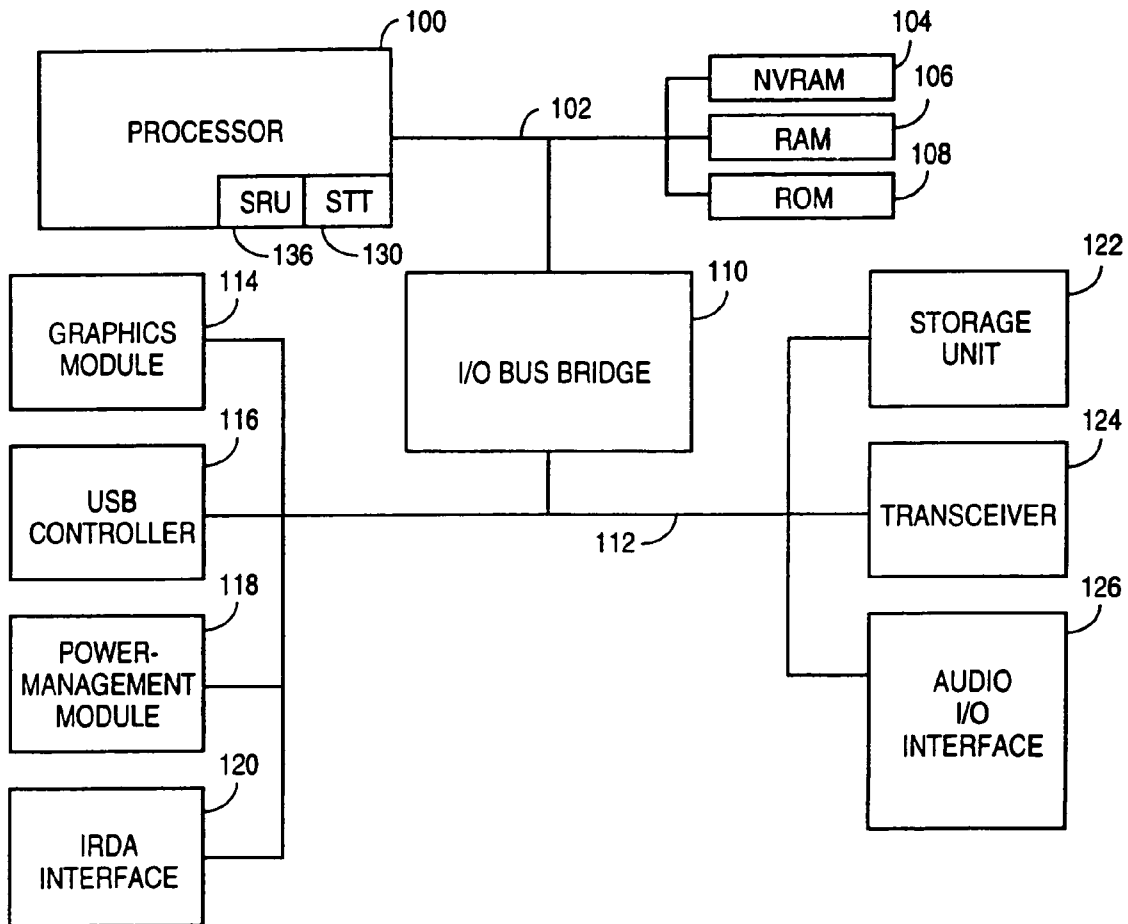

FIG. 4

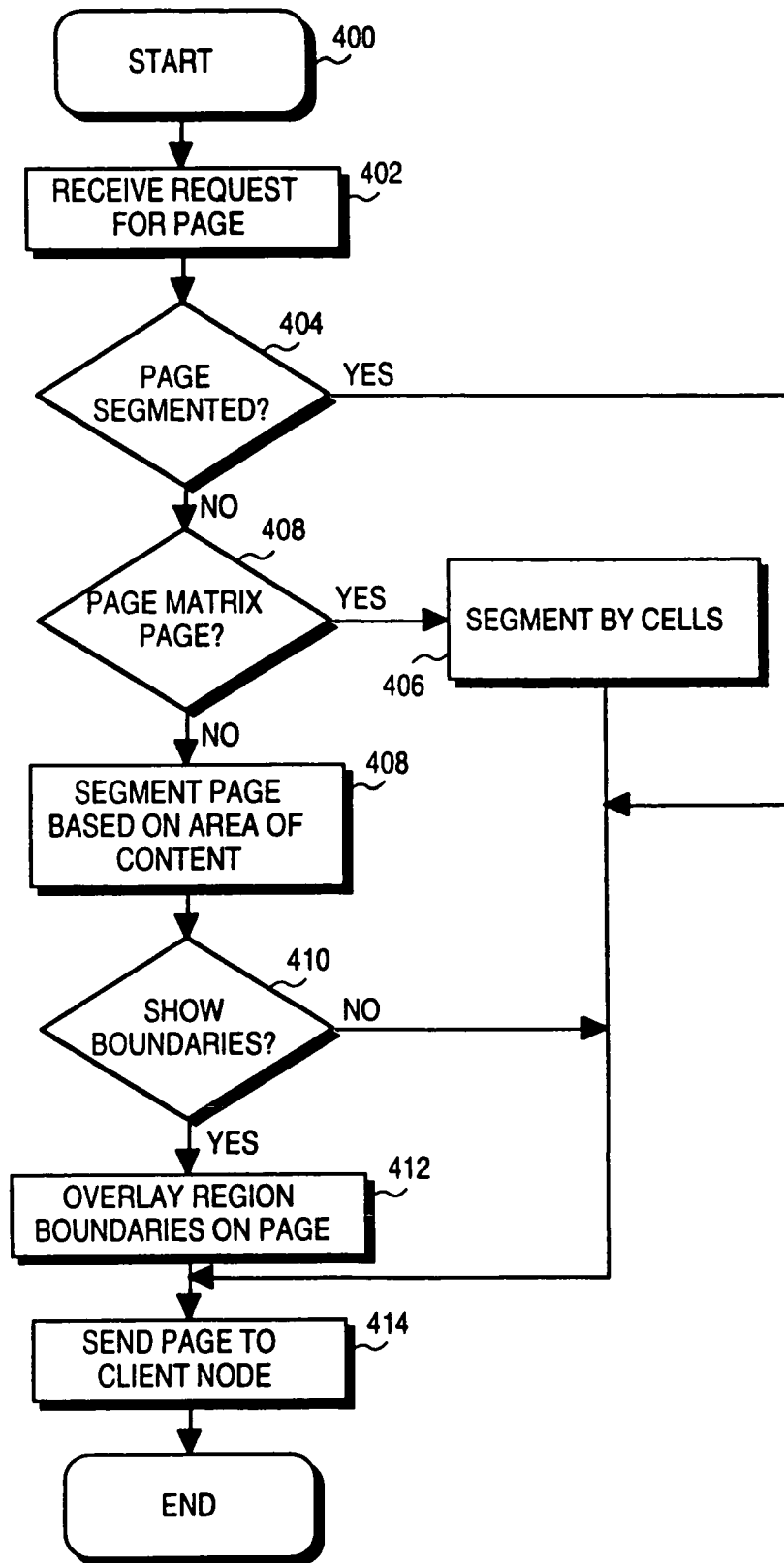

FIG. 5A

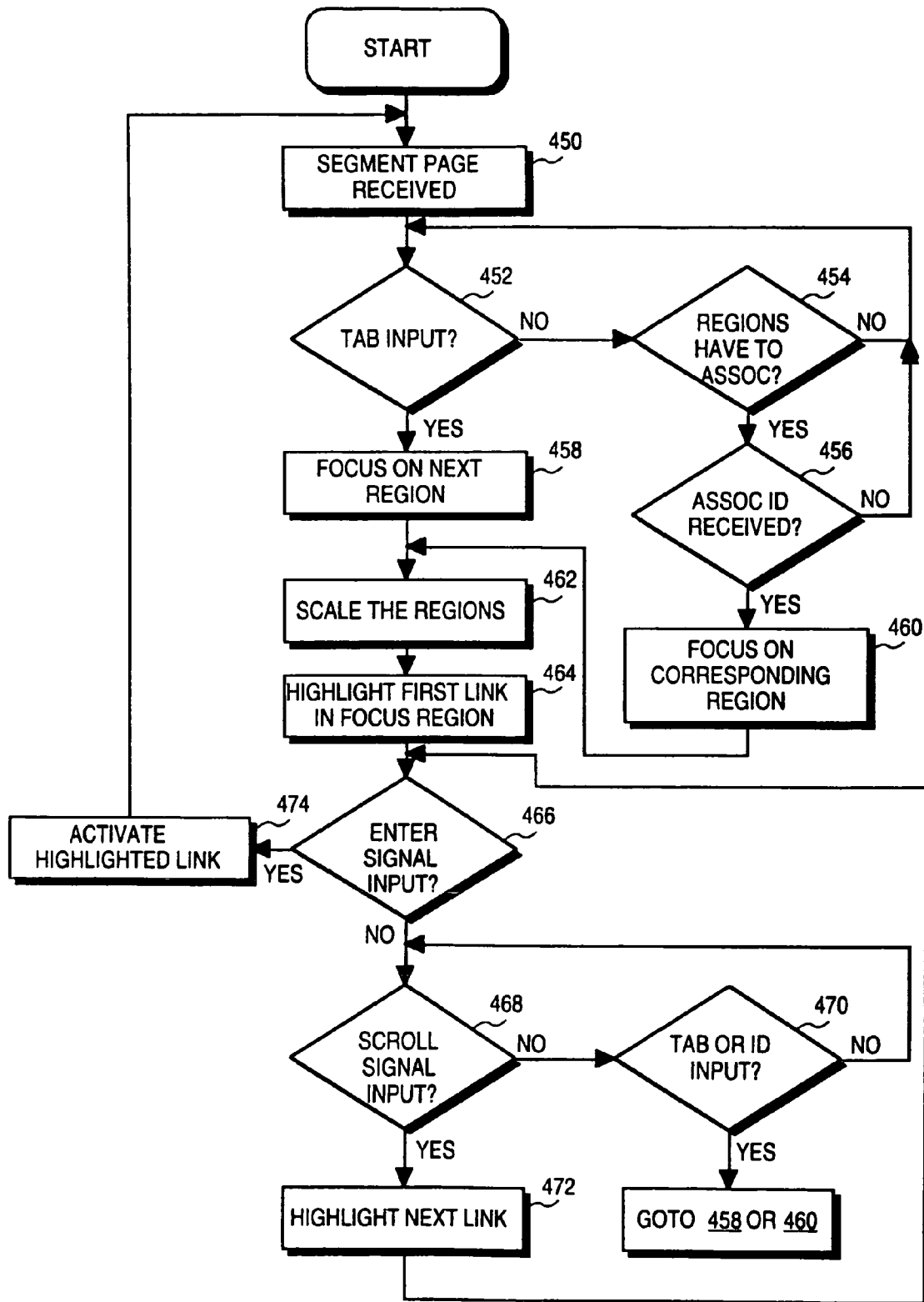

FIG. 5B

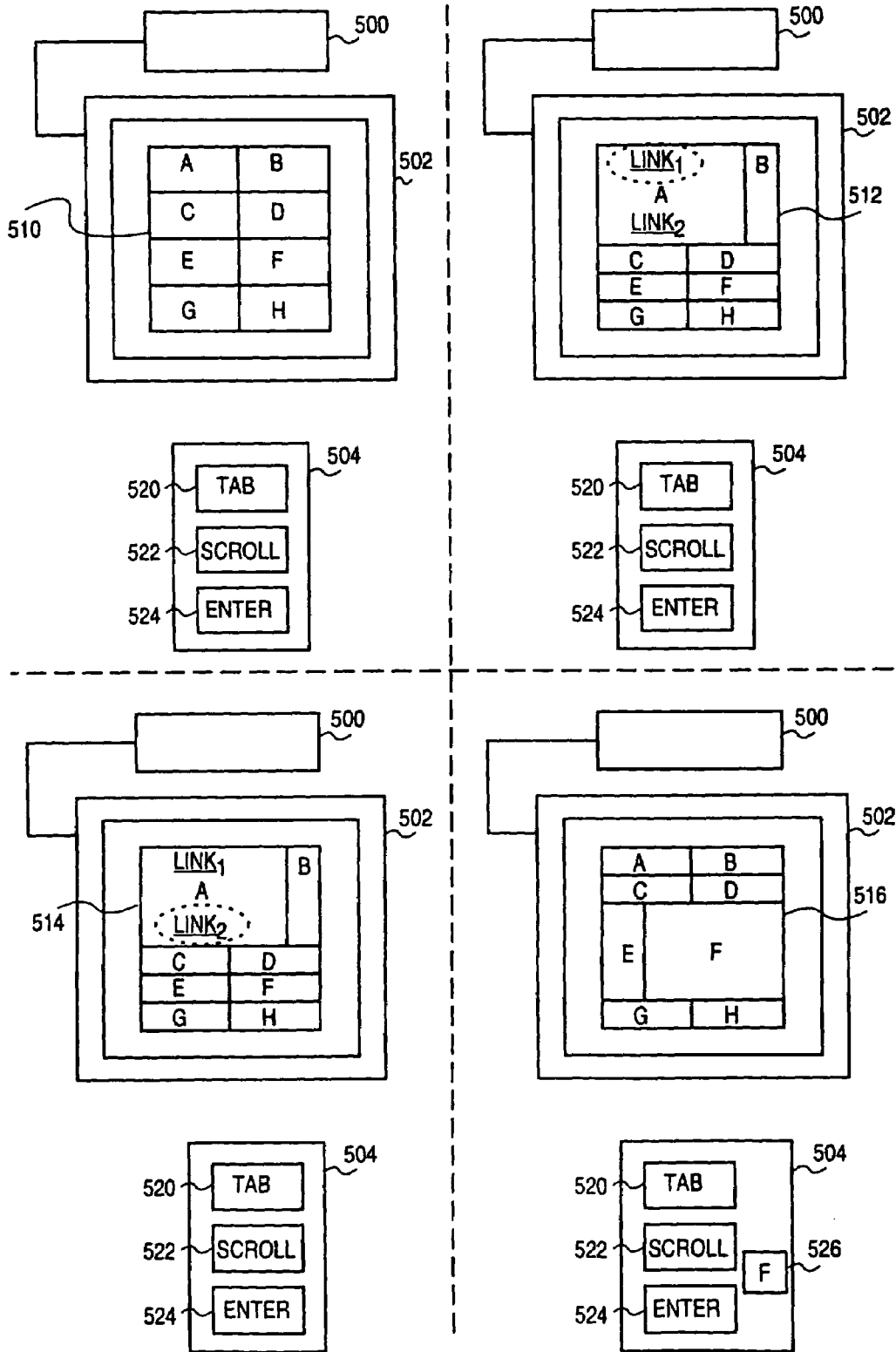

FIG. 5C

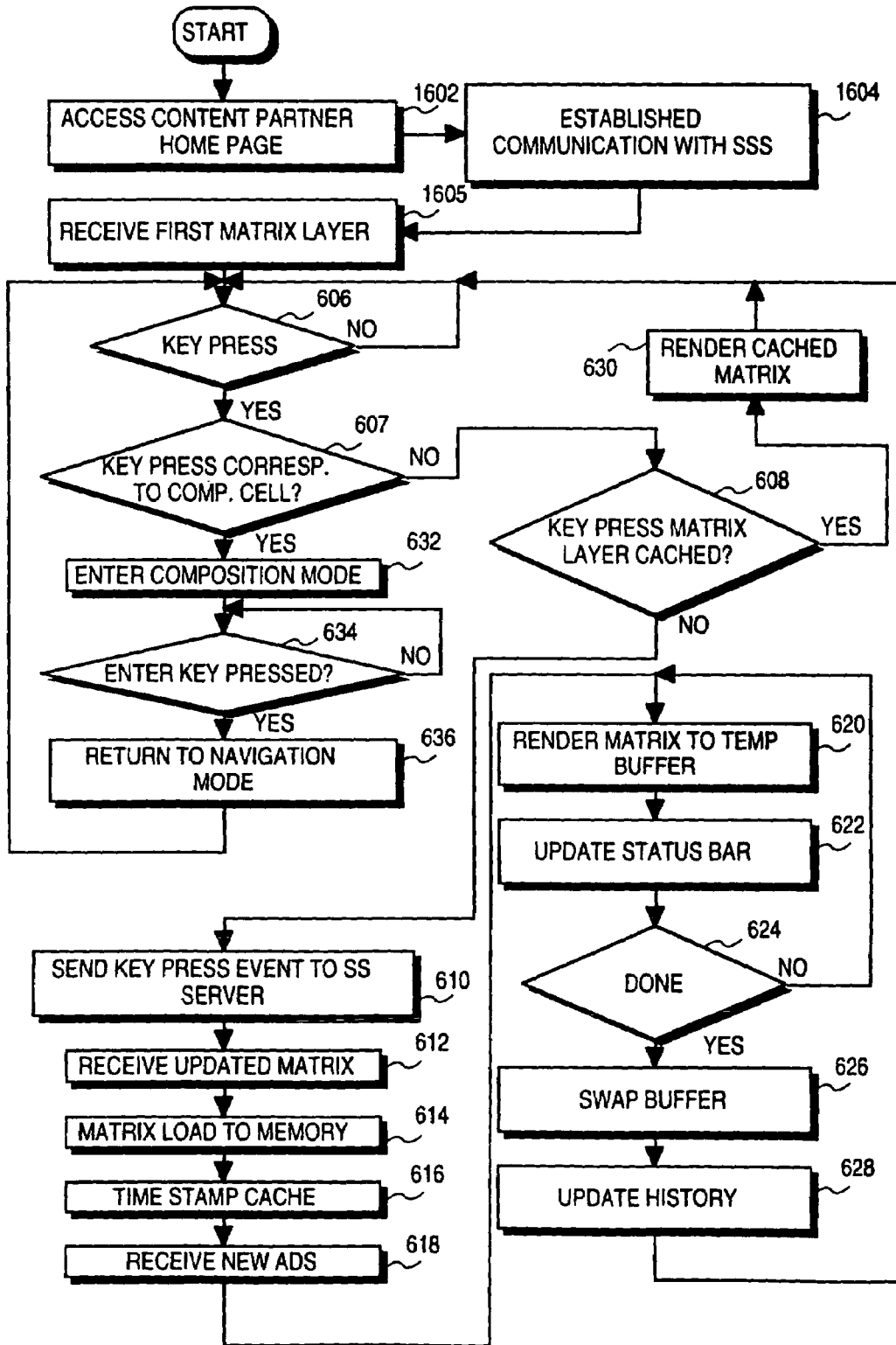

FIG. 6

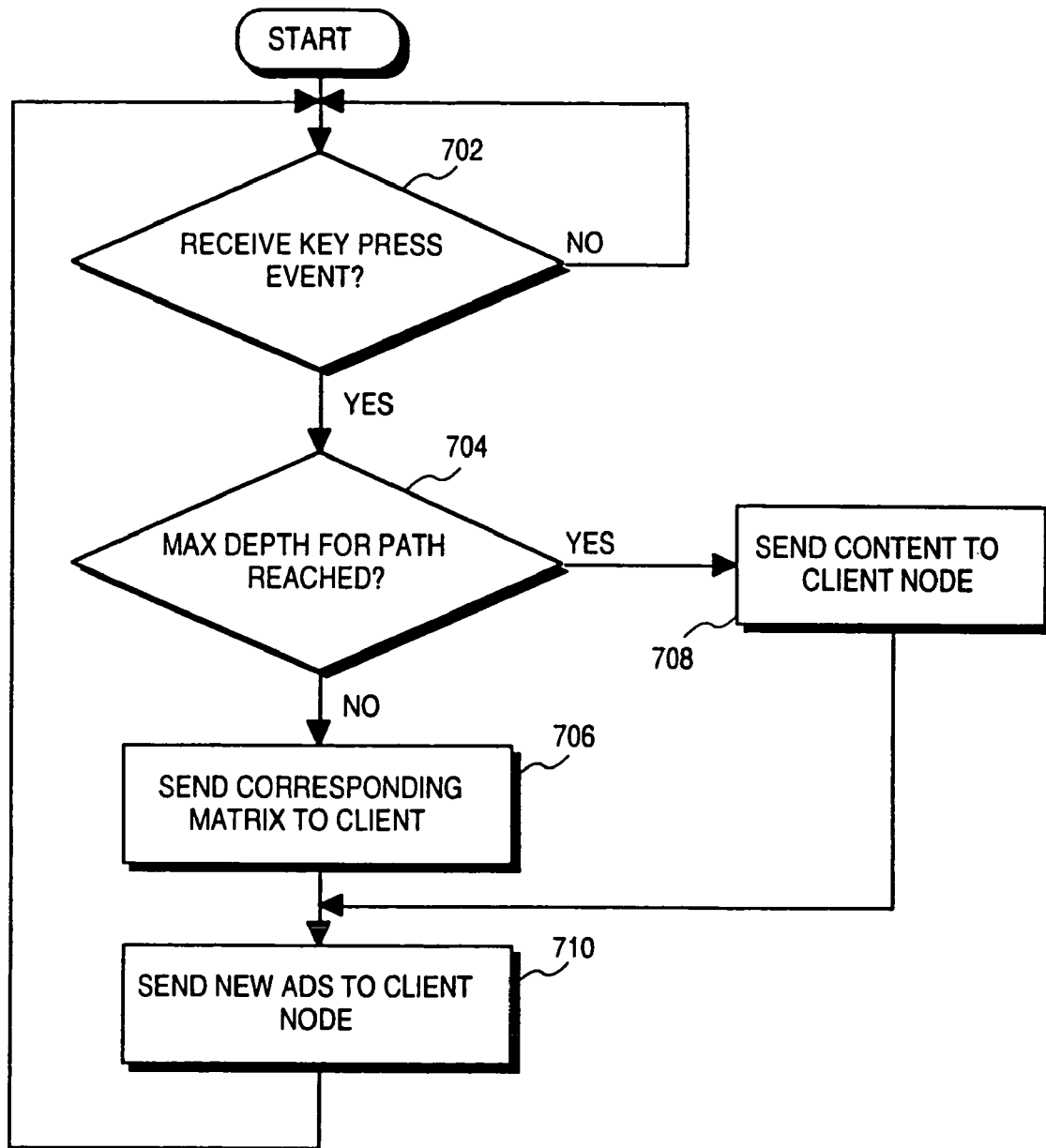

FIG. 7

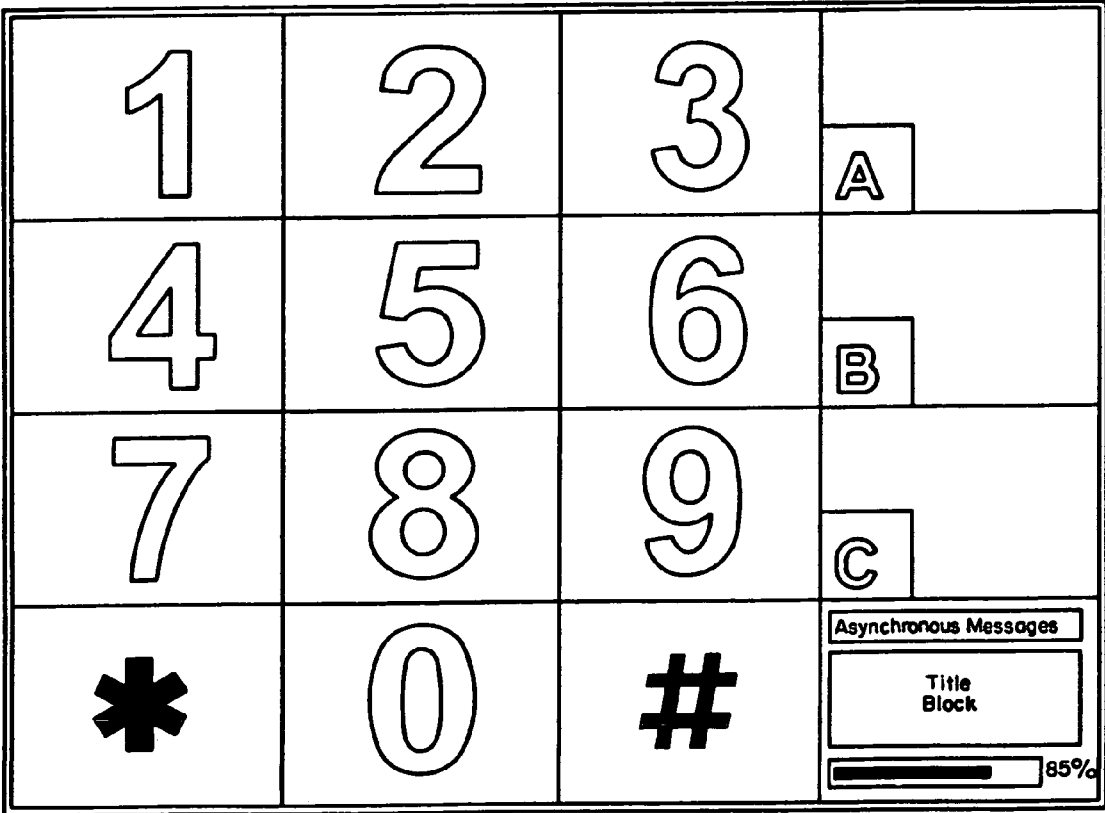

FIG. 8

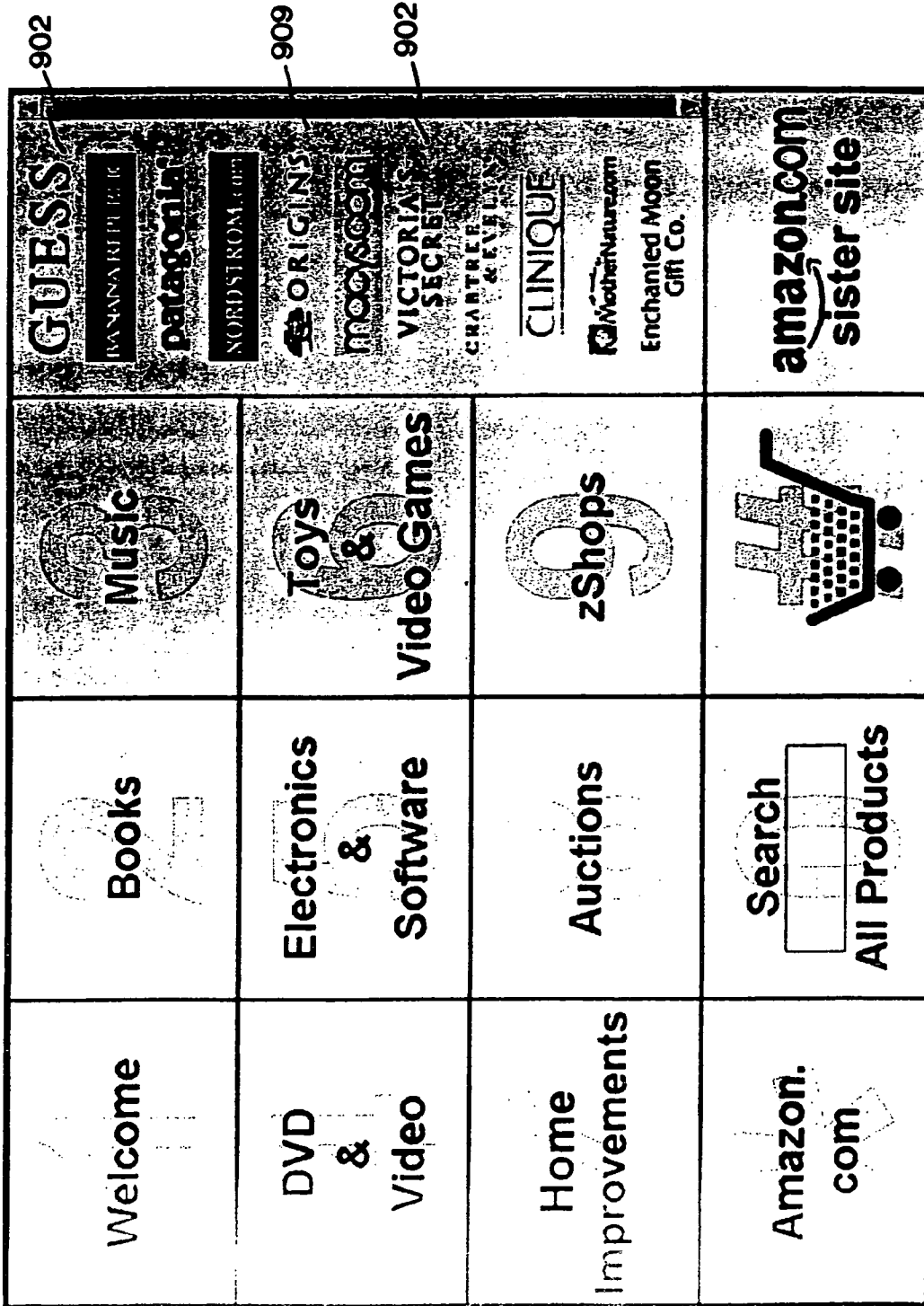

FIG. 9A

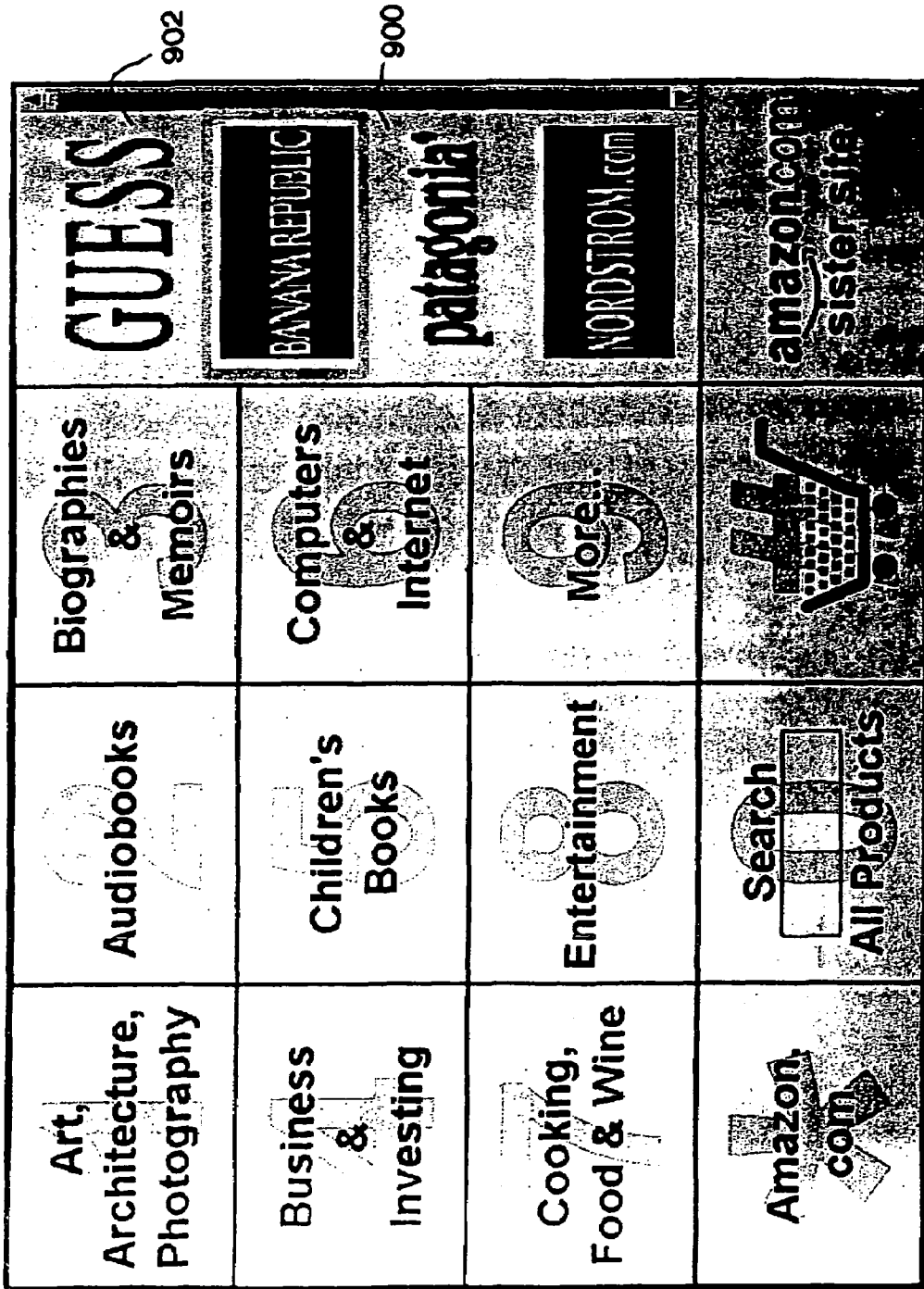

FIG. 9B

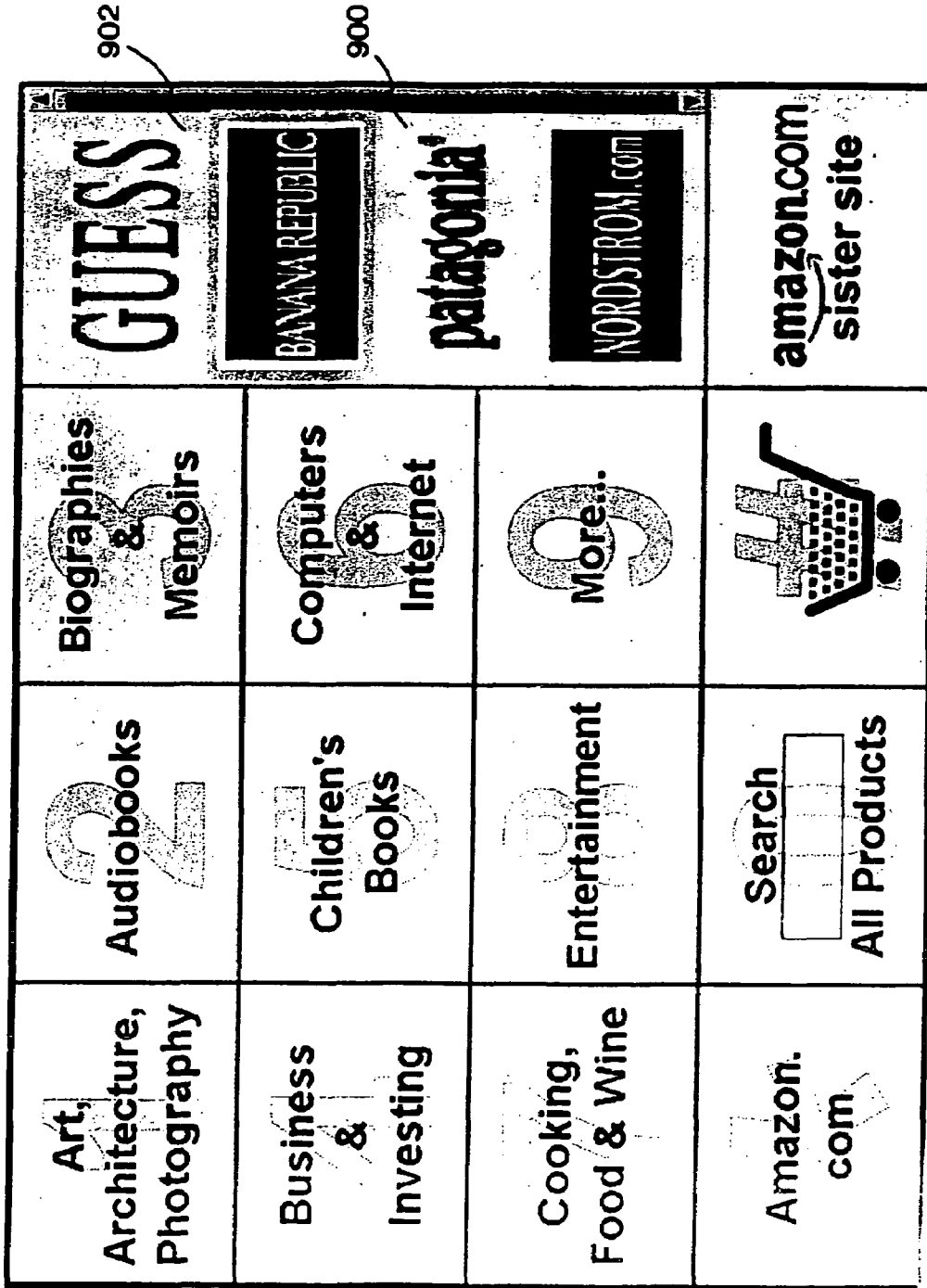

FIG. 9C

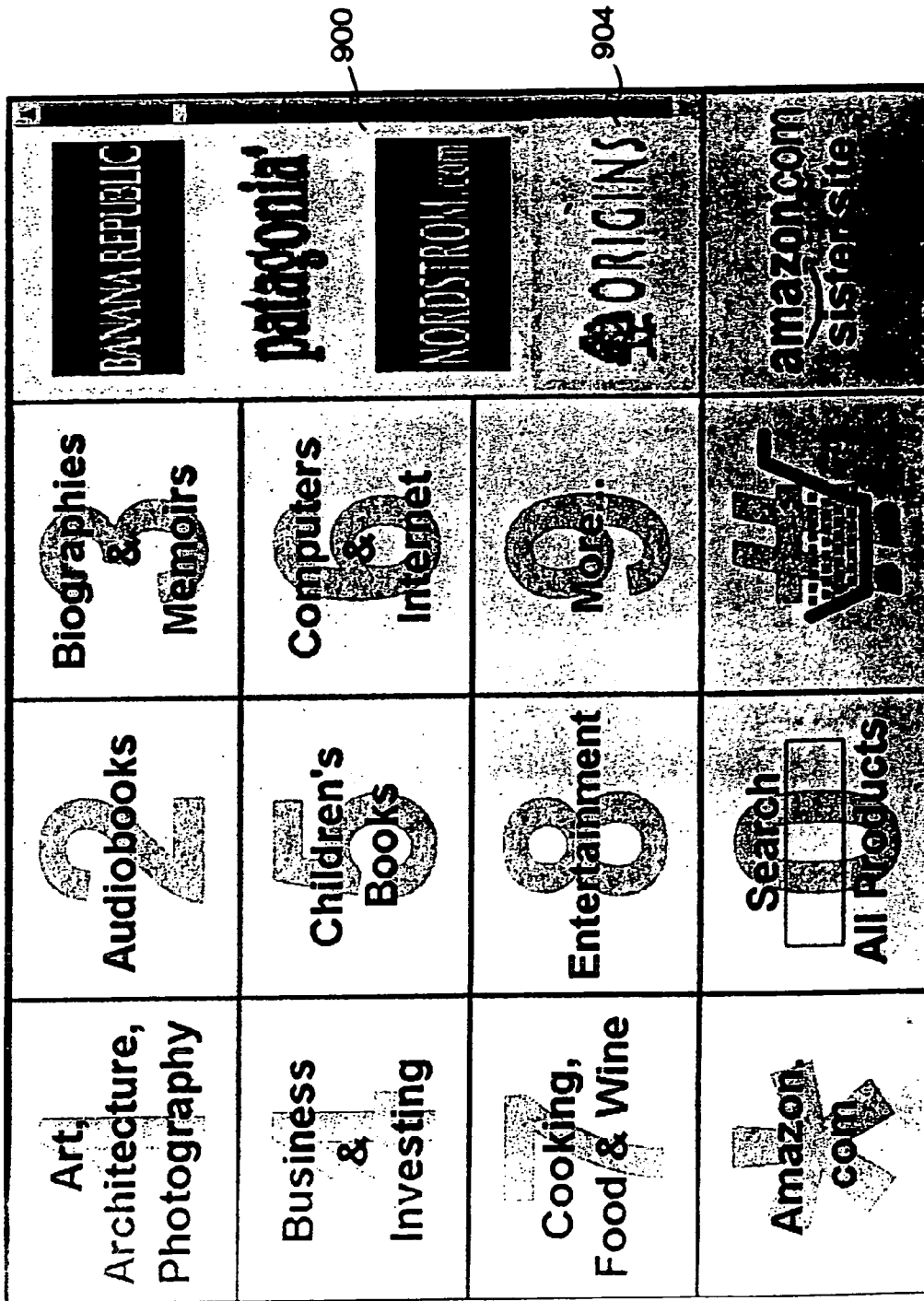

FIG. 9D

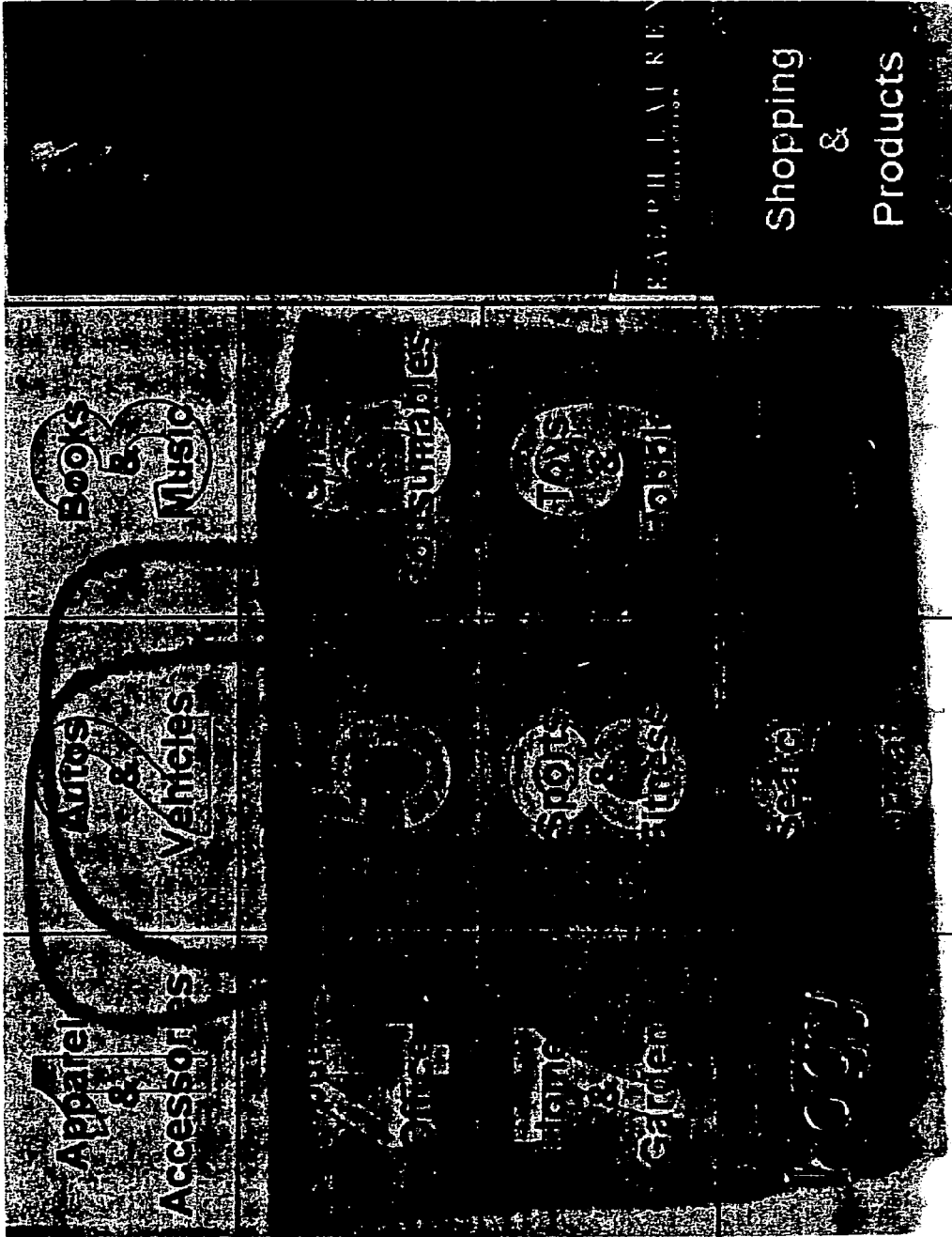

FIG. 10a

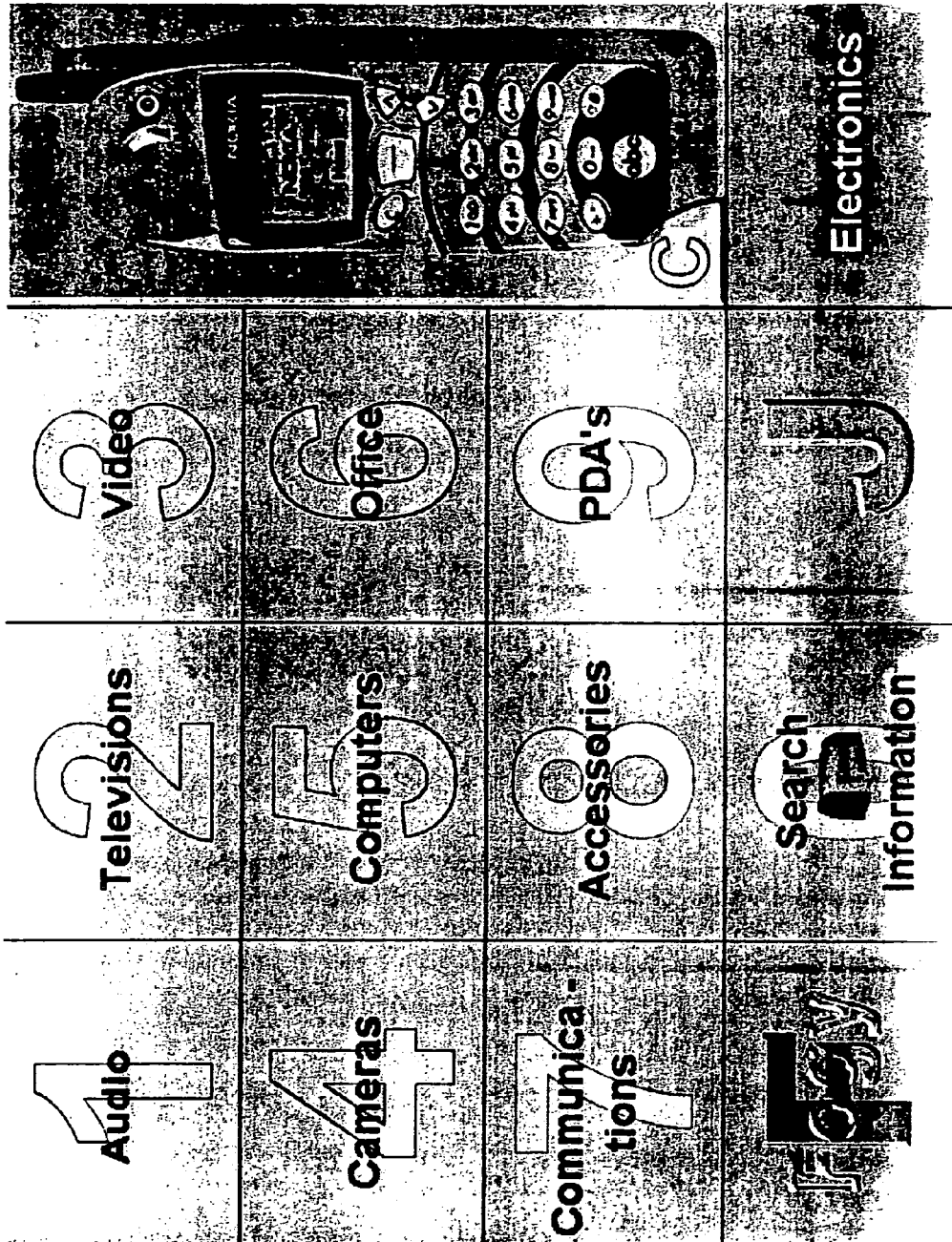

FIG. 10b

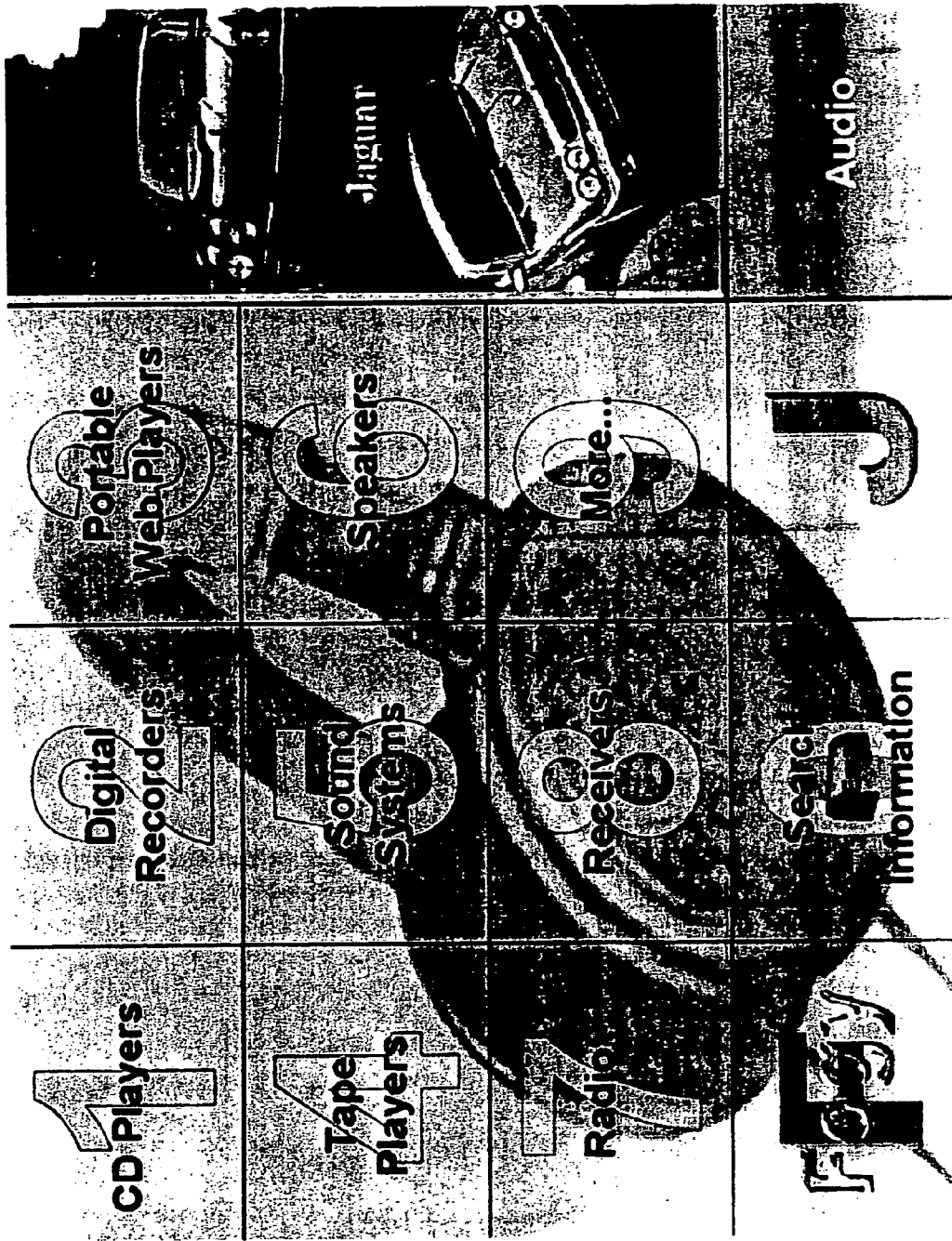

FIG. 10c

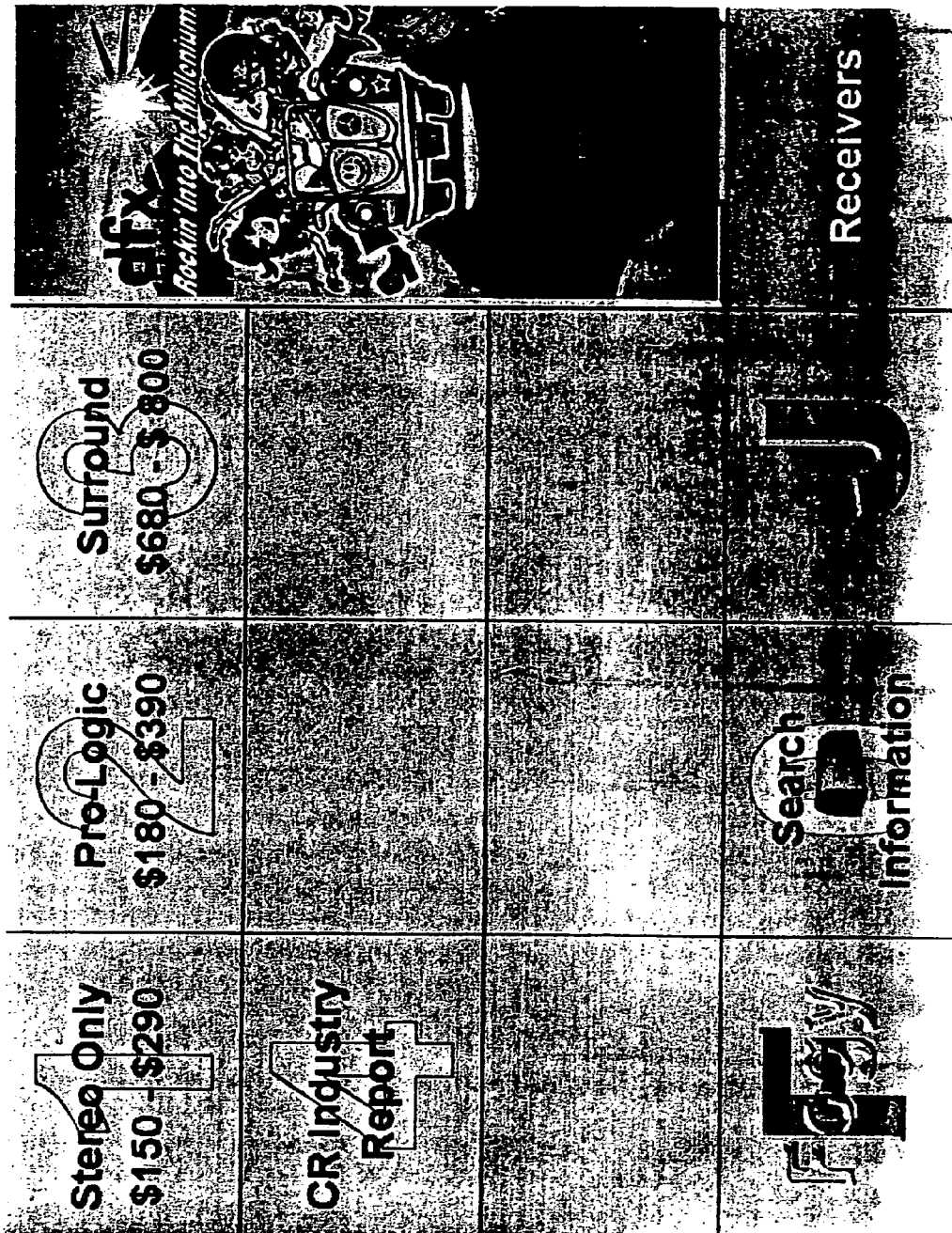

FIG. 10d











<p>Technics SA-EX 110 \$150</p> <p>Rank #1 Consumer Reports</p> 	<p>Sony STR DE 310 \$180</p> <p>Rank #2 Consumer Reports</p> 	<p>JVC RX 318BK \$160</p> <p>Rank #3 Consumer Reports</p> 	
<p>Onkyo TX 8511B \$290</p> <p>Rank #4 Consumer Reports</p> 	<p>Pioneer SX 255R \$160</p> <p>Rank #5 Consumer Reports</p> 	<p>Kenwood 104 AR \$170</p> <p>Rank #6 Consumer Reports</p> 	
<p>Rank #1 Consumer Reports</p> 	<p>Rank #2 Consumer Reports</p> 	<p>Rank #3 Consumer Reports</p> 	
<p>Rank #4 Consumer Reports</p> 	<p>Rank #5 Consumer Reports</p> 	<p>Rank #6 Consumer Reports</p> 	<p>Rank #7 Consumer Reports</p> 

FIG. 10e

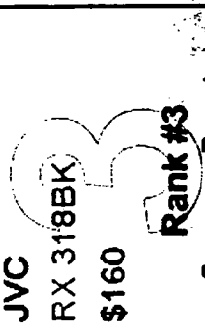
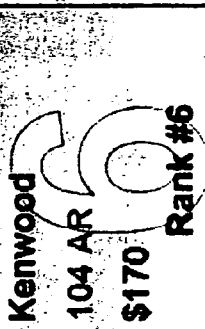

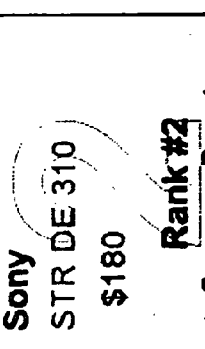
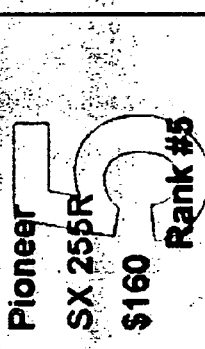

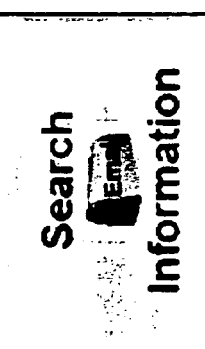
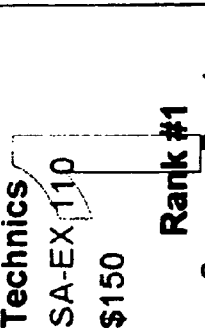
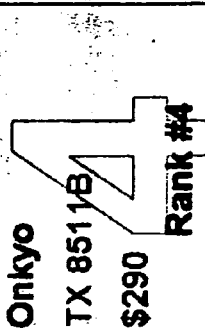
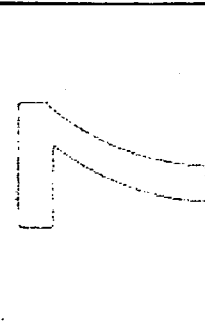
<p>Technics SA-EX110</p> <p>\$150 Our Price: \$129</p>  <p>Rank #1 Consumer Reports</p>	<p>Features</p>	
<p>Consumer Report</p>	<p>Specifications</p>	<p>PURCHASE</p>
<p>Similar Products</p>	<p>Search Information</p>	
		

FIG. 10f

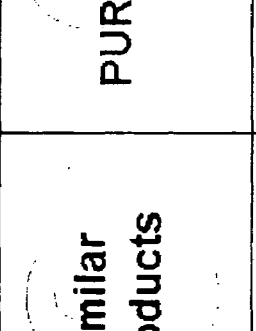
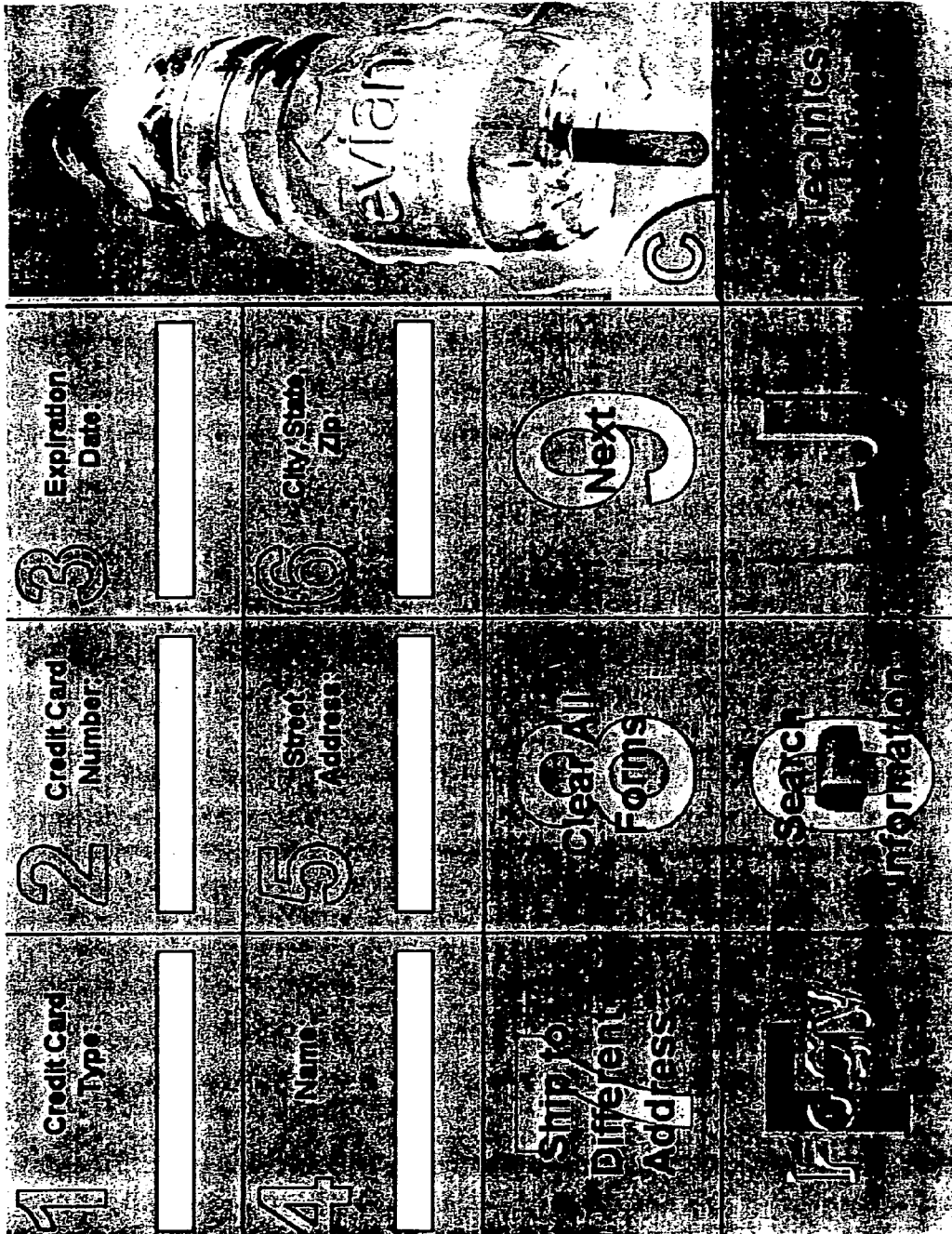

FIG. 10g

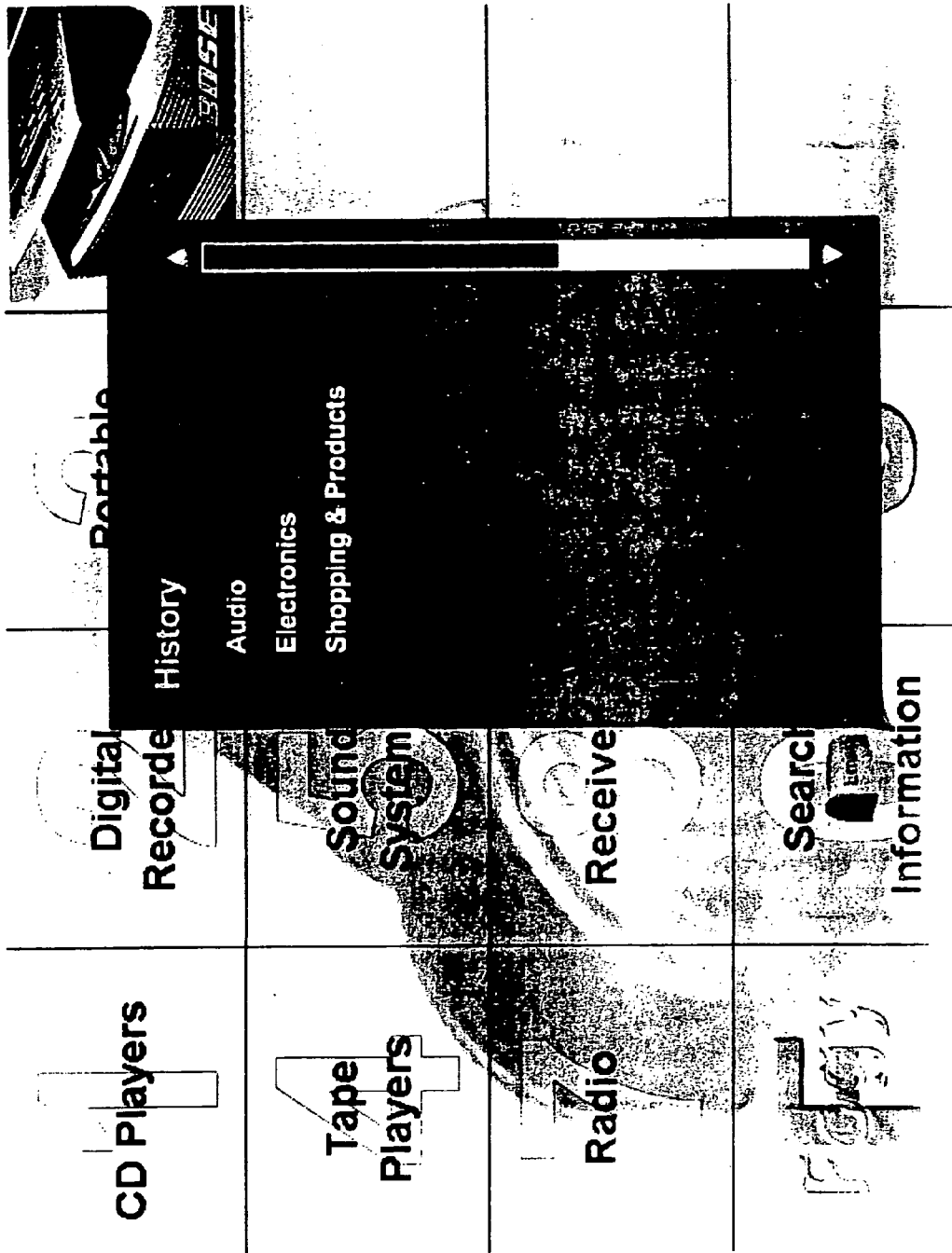

FIG. 11

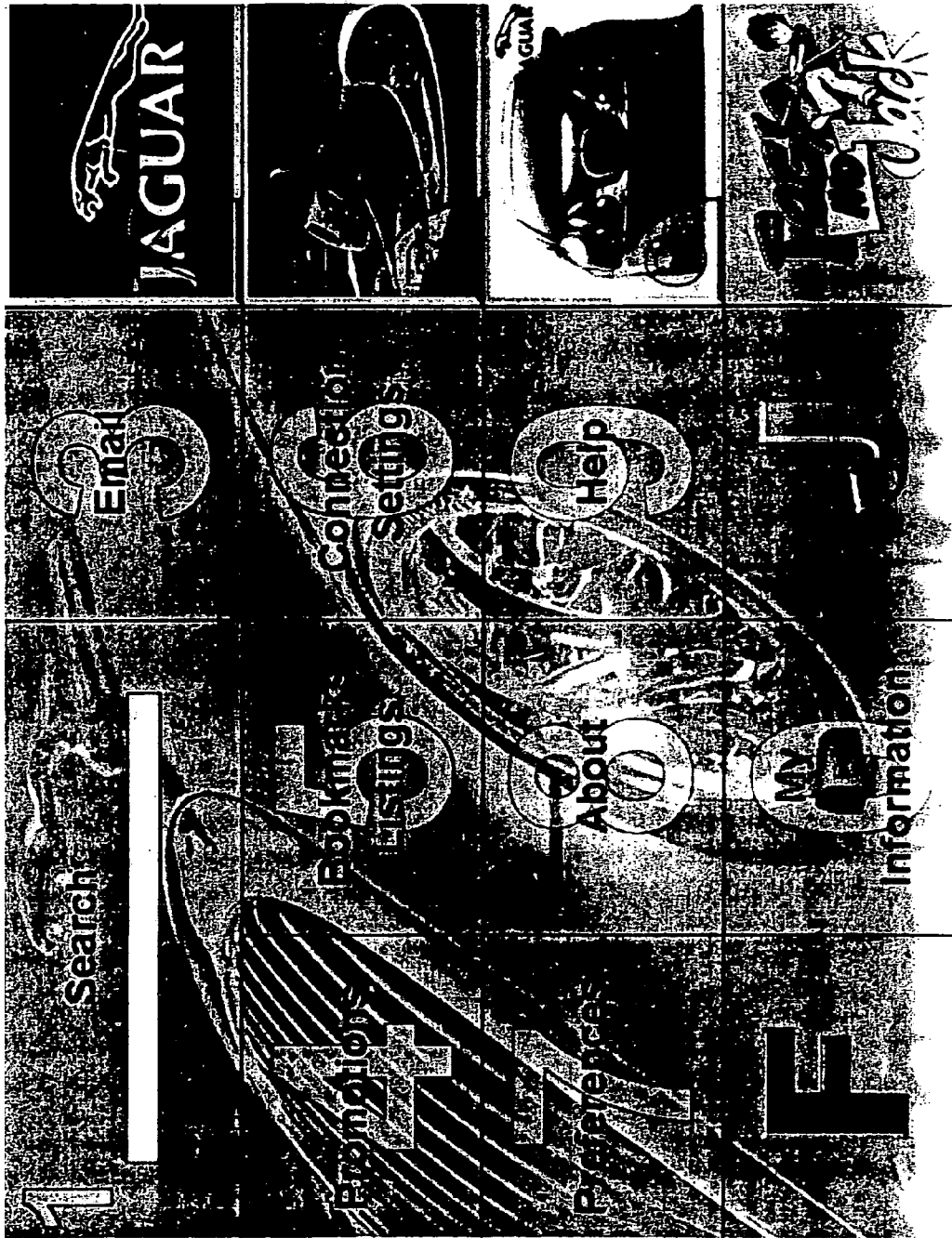

FIG. 12a

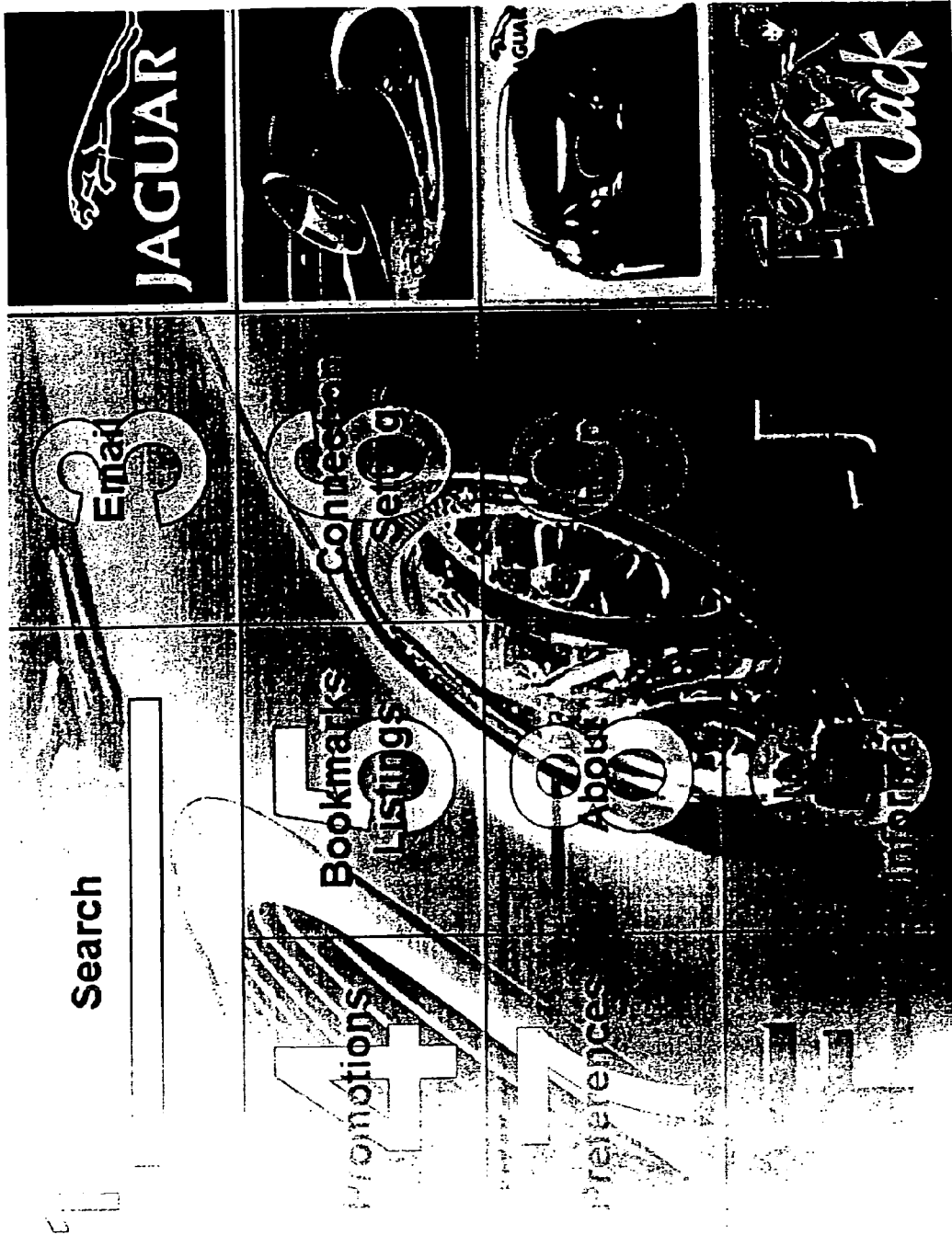

FIG. 12b

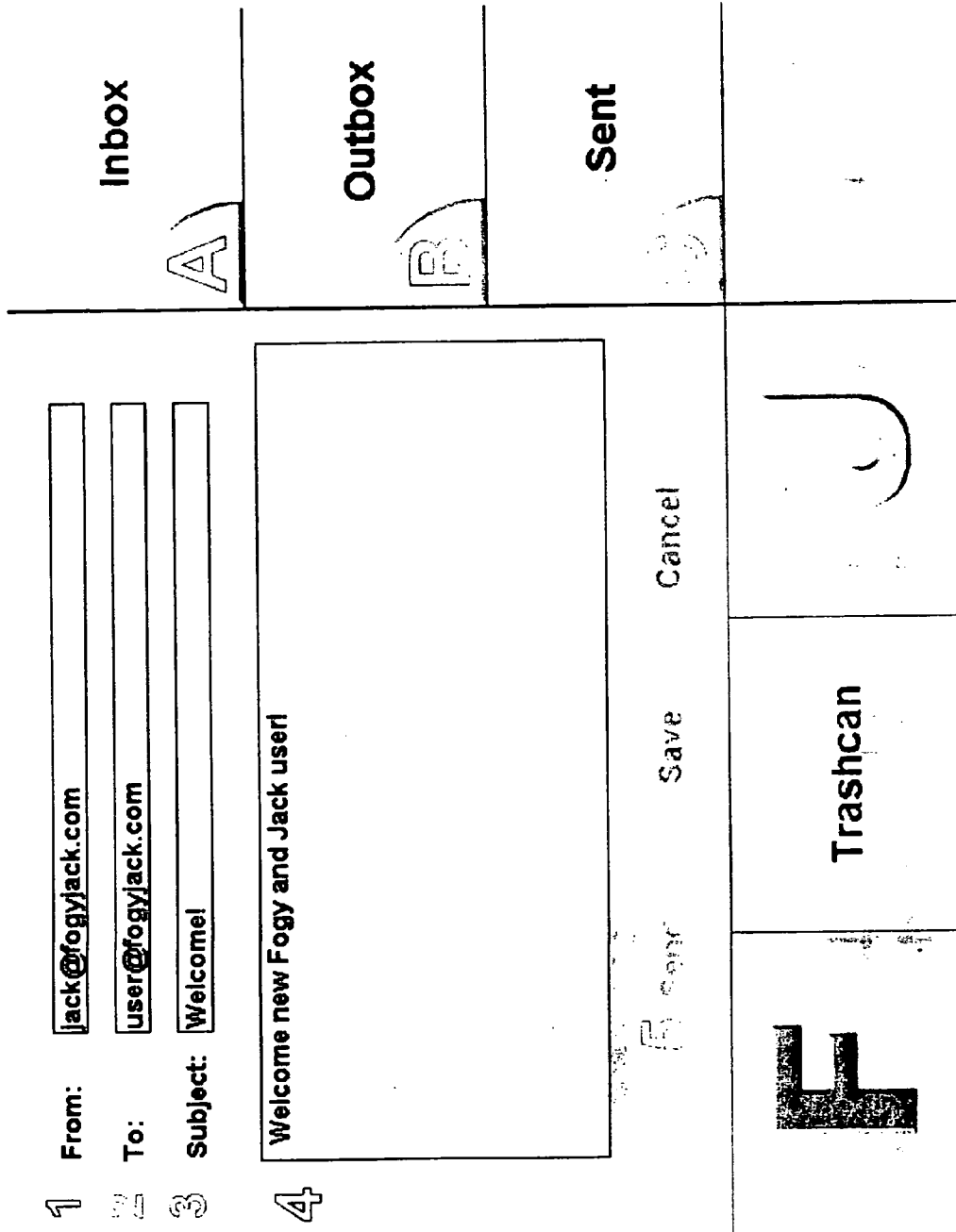

FIG. 13

					4	8
					3	7
					2	6
					1	5

FIG. 14

**APPARATUS AND METHOD OF
MANIPULATING A REGION ON A WIRELESS
DEVICE SCREEN FOR VIEWING, ZOOMING
AND SCROLLING INTERNET CONTENT**

CLAIM OF PRIORITY

This application, is a continuation of U.S. patent application Ser. No. 09/518,015, filed Mar. 3, 2000, which is a continuation-in-part of U.S. patent application Ser. No. 09/440,214, filed Nov. 15, 1999, issued as U.S. Pat. No. 6,600,497, each of which are incorporated herein by reference.

BACKGROUND

(1) Field of the Invention

The invention relates to electronic information services and electronic commerce services. More specifically, the invention relates to providing easy navigation to facilitate access to such services and improved web access through a television display, internet appliance, and wireless devices.

(2) Background

The importance of the Internet as a tool of electronic commerce can not be overstated. The ability of consumers to buy products, obtain information from the comfort of their own home is revolutionizing the way business is done. Increasingly, there is a push to provide access to the Internet on standard television monitors through the use of set top boxes. Over time, much like cable-ready televisions, it is expected that Internet-ready televisions will proliferate. Unfortunately, even on large screen televisions the web surfing experience is poor, inasmuch as the web content is illegible and/or unnegotiable, unless you happen to be sitting very close to the television. Generally, this makes web surfing impractical in more traditional television environments. As the television web access systems proliferate, improved navigation and content access on the television is likely to become a necessity.

BRIEF SUMMARY OF THE INVENTION

A method and apparatus of simplified navigation is disclosed. A web page is provided having a link to a sister site. The sister site facilitates simplified navigation. Pages from the sister site are served responsive to actuation of the sister site link. In one embodiment, the sister site includes matrix pages to permit matrix navigation.

BRIEF DESCRIPTION OF THE DRAWINGS

FIG. 1 is a block diagram of a system employing one embodiment of the invention.

FIG. 2a is an exemplary web page having a sister site link.

FIG. 2b is an exemplary first matrix page of a sister site for the web page of FIG. 2a.

FIG. 2c is a web page having irregular segmentation.

FIG. 3 is a flow diagram of conversion of standard HTML pages to a sister site format in one embodiment of the invention.

FIG. 4 is a block diagram of a client hardware architecture of one embodiment of the invention.

FIG. 5a is a flow diagram of server side segmentation in one embodiment of the invention.

FIG. 5b is a flow diagram of client side manipulation of a segmented page in one embodiment of the invention.

FIG. 5c is a diagram showing a system implementing the tab, scroll, and zoom features of one embodiment of the invention.

FIG. 6 is a flow chart of operations of the navigation system of one embodiment of the invention in a custom terminal custom browser node.

FIG. 7 is a flow diagram of operation of the sister site server of one embodiment of the invention.

FIG. 8 is a diagram of the display of a graphical user interface of one embodiment of the invention.

FIG. 9a-d are examples of sister site matrix pages.

FIGS. 10a-g are a series of matrix layers displayed during an exemplary navigation using one embodiment of the invention.

FIG. 11 shows a history window overlying a navigation matrix layer.

FIGS. 12a and b are an example of a matrix layer of one embodiment of the invention.

FIG. 13 is an e-mail composition matrix layer for one embodiment of the invention.

FIG. 14 shows an alternative matrix page of one embodiment of the invention.

DETAILED DESCRIPTION

A simplified system for navigation of the Internet or other content source allows access to the content and services available thereon with greater ease, on, for example, a display more remote from a user than in the use of the "traditional" personal computer (PC) two foot paradigm.

FIG. 1 is a block diagram of a system employing one embodiment of the invention. A wide-area network (WAN) 10, such as the Internet, couples together a plurality of communication nodes. Some nodes, such as node 12, may be a standard prior art PC executing any conventional web browser. Alternatively, node 12 might be a set top box and television, or an internet appliance, or a wireless device, such as a web-enabled cell phone. Additionally, there are server nodes connected to WAN 10, such as server node 16, which may be any conventional web server. Also coupled to WAN 10 are browser nodes 22 running a custom browser that facilitate access to information and services provided to the custom browser node 22. The custom browser node 22 as well as any browser nodes 12 are collectively referred to as client nodes. Content partners, such as content partner node 14 provide content in a specified format that facilitates its use by the client nodes 12, 22. In one embodiment, when a user accesses a content partner home page, they have the option of linking to a sister site. As used herein, "sister site" is deemed to mean a site that provides for navigation of the site using a simplified navigation system, such as matrix navigation described in more detail below. In one embodiment, the sister site is traditional HTML pages converted to a matrix format to permit matrix navigation. This conversion may be done using an XML transcoding or any other suitable language.

Content partners may maintain a database of sister site web pages corresponding to the pages in the general use site. Alternatively, content partners may provide a facility for converting web pages on the fly to the sister site format. Content partners may also provide for segmentation of the base HTML web pages and/or the matrix pages. A segmentation may be performed in a number of ways. The page may be divided up based on content or area. The net result, in any case, is that the web page is divided into regions which are not necessarily, but may be, of equal size. The individual regions may be brought into focus independently. By "brought into focus," the concept of focus in this context is analogous to the

front window in a windowing system. The focus region is deemed active and subject to client manipulation. In the context of a matrix page, one suitable segmentation is by cell, e.g., each cell corresponds to a region that may be independently brought into focus. The borders of the regions may or may not be visible on the web pages displayed. This segmentation facilitates tab, scroll, and zoom features described in more detail below. Alternatively, segmentation may be performed as part of a custom browser on custom browser nodes or may be instantiated as a hardware or firmware solution within, for example, the set top box.

FIG. 2a is an exemplary web page having a sister site link. By actuating the link, the client begins receiving matrix pages as described in more detail below. FIG. 2b shows an example first matrix page reached by activating the sister site link in FIG. 2a. FIG. 2c is a web page having irregular segmentation. Through segmentation, the page is divided into regions. Individual regions may then be brought into focus permitting simplified navigation, viewing, and manipulation of the data within that region.

FIG. 3 is a flow diagram of conversion of standard HTML pages to a sister site format in one embodiment of the invention. A hypertext markup language (HTML) page 40 is transcoded by a transcoder 30 to yield, for example, an XML page 42 to which a document type definition (DTD) 38 is applied. The DTD 38 specifies the rules for the structure of the resulting XML document. The XML page is then reformatted using extensible style language (XSL) 34 to corresponding format data 32. XSL is not currently supported by all standard browsers. Thus, after formatting, the XML document is translated to an extensible hypertext markup language (XHTML) document for subsequent display by a client side browser on display 52. Alternatively, the XML page may have a cascading style sheet (CSS) applied to achieve the desired format. One advantage of the CSS is that it is supported by standard browsers. After application of the CSS, the resulting formatted page can be displayed by the client browser on display 52.

The above-described conversion may be done by a content partner in advance of request for pages or may be done on the fly responsive to requests for pages. The determination of which to do involves a trade off between latency in providing requested pages and storage space required to store the additional pages. Some on the fly conversion is desirable in the event that a user attempts to access a web site that has not previously been converted. It is also within the scope and contemplation of providing for conversion on the client side.

FIG. 4 is a block diagram of a client hardware architecture of one embodiment of the invention. A processor 100 is coupled to various memory units and an I/O bus bridge 110 by a local bus 102. Among the expected memory units are random access memory (RAM) 106, which may be any standard RAM, including standard dynamic random access memory (DRAM), and may be symmetric or asymmetric. Also coupled to bus 102 is a read-only memory (ROM) unit 108. The ROM will typically include the boot code for the processor 100. A non-volatile RAM (NVRAM) unit 104 is also coupled to the bus.

The I/O bus bridge 110 is coupled to the local bus 102 and bridges to the I/O bus 112. A number of units may reside on the I/O bus, including a graphics module 114 that couples to a display (not shown), a universal serial bus (USB) controller that may couple the system to any number of additional USB devices. Common USB devices include keyboards, mice, cameras, scanners, printers, and other peripheral components and input/output devices. Also coupled to the I/O bus may be power management module 118, which may be coupled to the power switch and may include conventional power conserva-

tion protocols, ensuring the processor 100 is permitted to orderly conclude its current operation before changing power states.

An infrared data association (IrDA) interface 120 permits the terminal to be coupled to hand-held devices, if desired. In some embodiments, a keyboard may be coupled by an Ir link. Storage unit 122, which may, for example, be a flash memory unit, is used for long-term storage of data or files. A transceiver 124 is used to permit the processor to communicate with the hub, whether it be a point-to-point link or across a wide-area network. The transceiver 124 may be, but is not limited to, an ethernet transceiver, a modem, digital subscriber line (DSL) or cable modem. It is expected that the processor 100 will communicate through the transceiver 124 to the server using transmission control protocol/internet protocol (TCP/IP). Encryption and compression within the terminal may be handled by conventional hardware or software solutions.

Audio I/O interface 126 may include an internal microphone and speaker which permits audio input and output. This is particularly useful in the context of voice e-mail or voice over IP communications. Additionally, some embodiments of the invention will include speech to text (STT) capability 130 and speech recognition (SR) capability 136. Various embodiments may implement these capabilities as hardware or software or a combination of both. In embodiments having SR capability, for simplicity of use, it is desirable to use one of the multiple user SR packages available today and expected to improve in the future, as these packages avoid the necessity of "training" the system. This permits recognition of content of speech and conversion to text.

For purposes of reduced cost, it may be desirable to use a particularly simple speech recognition package, recognizing only, for example, numbers and letters. A suitable speech recognition package will permit a user to navigate the WAN as subsequently described using voice commands and composed e-mails in a hands-free manner. Such an embodiment has the additional advantage that it enables Internet access to the physically challenged. In some embodiments, SR 136 is present, but STT 130 is not. This may permit the processor to respond to voice commands but would not permit composition of e-mail, for example.

In one embodiment of the invention, the terminal has a notebook form factor with an integrated LCD display. In an alternative embodiment, the form factor is a set-top box, which relies on an external display, such as a television or external monitor. In either case, a standard QWERTY keyboard could be used. In the set top box embodiment, a wireless keyboard or remote is desirable.

FIG. 5a is a flow diagram of server side segmentation in one embodiment of the invention. A request for a page is received at functional block 400. A determination is made at decision block 402 whether the requested page has been segmented. If the page has not been segmented, a determination is made at decision block 404 whether the requested page is a matrix page. If the requested page is a matrix page, at functional block 406, the cells of the matrix are each defined to be a region, thereby completing the segmentation. If the page is not a matrix page, the page is segmented either based on area or content. By "segmentation," it is meant that the page is divided into a plurality of regions. The regions may contain one or more links and/or some amount of content. This segmentation facilitates usability as discussed in more detail below. Once segmentation is complete, at functional block 408, a determination is made if the boundaries of the regions should be shown on the displayed page at decision block 410. If the boundaries are to be shown, the boundaries

5

are overlaid on the page at functional block 412 after the overlay, or if no boundaries are to be shown, the page is sent to the client node at functional block 414.

FIG. 5b is a flow diagram of client side manipulation of a segmented page in one embodiment of the invention. At functional block 450, a segmented page is received at a client node. A determination is made at decision block 452 if a tab input has been received. As used herein, a tab input is any input which brings about the functionality of moving the focus from one region to another adjacent region. If no tab input has been received, a determination is made at decision block 454 if the regions have identifying symbols associated therewith. Particularly in the case of matrix pages, the different cells typically have associated therewith either an alphanumeric character or some symbol such as an asterisk or other punctuation mark to identify the cell. If there are identifications associated with the regions, a determination is made at decision block 456 if such an identification has been received as an input on the client node. If the identification has been received, the corresponding region is brought into focus. The focus region is active, and in some embodiments, the corresponding region is zoomed to increase its size relative to the inactive regions at functional block 460. If no identifications are associated with the region or no identification is received, the client waits for a tab input at decision block 452.

If a tab input is received, the next region is brought into focus. If no region is currently in focus, a first region, e.g., the uppermost leftmost region, will be brought into focus at functional block 458. At functional block 462, the regions are scaled so that the in focus region is enlarged relative to the regions which are not in focus. This is particularly desirable for web browsing in a television context where distance from the set may make reading the unscaled page difficult or impossible. Thus, by scaling region by region, readability within the region can be enhanced to permit use and browsing from a distance.

At functional block 464, a first link in the focus region is highlighted. As used herein, "highlighted" means made active such that a subsequent input, such as a predefined key press activates the link. Highlighting in the link context is analogous to focus in the region context. Highlighting may, but need not include, changing the link's appearance in any manner on the display such as, for example, changing size, color, shading, etc. A determination is made at decision block 466 if an enter signal has been received. However, if no enter signal has been received, a determination is made at decision block 468 if a scroll signal has been input at the client node. If a scroll signal has been input, a next link is highlighted at functional block 472. If an enter signal is received at functional block 466, a then highlighted link is activated at functional block 474 and a next segmented page is received, and the process begins again. Alternatively, if no scroll signal input is received at decision block 468, a determination is made at decision block 470 whether a tab or identification input has occurred. If it has, the system continues processing at blocks 458 or 460, respectively.

FIG. 5c is a diagram showing a system implementing the tab, scroll, and zoom features of one embodiment of the invention. A set top box 500 is coupled to a television monitor 502 and is responsive to remote control 504. Remote control 504 may be a custom remote control, a wireless keyboard, or even a standard universal remote control. Remote control 504 may be equipped with a microphone for accepting voice commands or may merely provide push button inputs. In frame one, television 502 is displaying a web page 510 that has been segmented into eight equally dimensioned regions A-H. Remote control 504 includes a tab function 520, a scroll

6

function 522, and an enter function 524. Responsive to actuation of the tab function, region A is brought into focus, as shown in the second frame. Link one is highlighted and A is enlarged, while the remaining regions are scaled so that A is much larger relative to the other regions, thereby accomplishing a zoom function and improving readability of the information contained in region A. This is shown as web page 512. If, when A is in focus, the user actuates scroll function 522, a second link in region A is highlighted as shown on page 514. In one embodiment, scrolling within the focus region does not effect the size or representation of the non-focus regions. In the event that, at web page 512 or web page 514, the enter function 524 is actuated, link₁ or link₂ would be traversed, respectively. If the segments are actually associated with their alphanumeric designator, and that remote control 504 has alphanumeric keys, for example, letter key F 526, web page 516 shows a web page that would be reached from web page 510, 512, or 514 responsive to actuation of the F key. In web page 516, the F region is in focus, and the remaining regions are scaled to be much smaller than the F region.

These are merely illustrative examples of the tab, scroll, and zoom features of one embodiment of the invention. While the shown embodiment tiles the regions, it is within the scope and contemplation of the invention to overlay the focus region on one or more of the other regions. It is also within the scope of the invention to permit a user to increase the zoom of the focus region to exceed the physical space. In such case, scrolling within the region may be required to view the entire contents of the region. Such scrolling need not effect the display of the non-focused regions.

FIG. 6 is a flow chart of operations of the navigation system of one embodiment of the invention in a custom terminal custom browser node. Upon power-up at functional block 602, a content partners home page is accessed. In some embodiments, it may be possible to bypass access of the home page and go directly to the sister site home page. At functional block 604, a node establishes communication with a sister site server (SSS). At functional block 605, a first matrix layer is received from the SSS. At decision block 606, the node waits for a keypress. If at decision block 606, a determination is made that a key has been pressed, a determination is made at decision block 607 whether the keypress corresponds to a composition cell. A composition cell is deemed to be a cell in the navigation matrix which permits a user to enter additional data. For example, a search cell or e.g., a purchase order form or an e-mail may have one or more composition cells. If the cell is a composition cell, the system enters composition mode at functional block 632. In composition mode, the digits of the keypad represent the digits themselves, rather than navigation options. The cursor will also appear in the composition field of the composition cell. At decision block 634, a determination is made if the enter key has been pressed. The enter key is defined in one embodiment of the invention to signify the end of a composition. Thus, if the enter key has not been pressed, the system remains in composition mode. However, if at decision block 634, the enter key has been pressed, the system returns to navigation mode at functional block 636. It is also within the scope and contemplation to define other keys to instigate return to the navigation mode.

If a keypress is received and not found to correspond to a composition cell at decision block 607, a determination is made at decision block 608 whether the matrix layer corresponding to the keypress exists within the cache. In this connection, it is determined whether a representation of that matrix layer, even if in the cache, is stale and therefore needs to be freshly downloaded. If the data is stale or not present in the cache at all, the keypress event is sent to the SSS. In one

embodiment, the entire navigation path, including the keypress event, is sent with each keypress. When the navigation path is sent with each keypress event, the SSS is able to identify the requested matrix layer rapidly on the fly.

Subsequently, at functional block 612, the client node receives the updated matrix layer corresponding to the keypress event. That matrix layer is loaded to the memory at functional block 614 and the cache is time-stamped at functional block 616. At functional block 618, new ads may be received from the SSS. Notably, the receipt of the ads is asynchronous with the matrix layer receipt and may occur at any time without being prompted by a keypress event. At functional block 620, the incoming matrix layer is rendered to a temporary buffer by using a double-buffering technique. The actual rendering is transparent to the user. At functional block 622, the status bar for the load is updated to indicate the percent complete of the matrix layer rendering. At functional block 624, a determination is made if the rendering is complete. If it is not, the buffer continues to render and the status bar continues to update. By regularly updating the status bar, the user is not left wondering if the device is working. This is expected to limit the frustration experienced by many new users during the wait while matrix layers are rendered. If the rendering is complete, the temporary buffer is swapped with the frame buffer and the new matrix layer is displayed at functional block 626. Then at functional block 628, the history of the navigation path is updated to reflect the new matrix layer. The system then returns to await a next keypress to indicate further navigation. By iteratively pressing appropriate keys, a user may navigate to any desired depth up to a maximum depth along any navigation path and obtain content relevant to the path navigated. If instead, the matrix layer was validly in the cache at decision block 608, the matrix layer is rendered from the cache at functional block 630 and the system awaits the next keypress.

“Maximum depth” as used herein applies on a cell by cell basis for primary navigation options. A maximum depth is reached for a cell in a navigation path when pressing a corresponding key will not take a user to a deeper matrix layer in the matrix. While content, as distinguished from the matrix layer and their cell headings, will be displayed once a maximum depth is reached, it is within the scope and contemplation of the invention to display some content in cells of an intermediate matrix layer, i.e. one that is not at the maximum depth.

“Primary navigation options” as used herein are those navigation options that necessarily change between successive matrix layers, changing from general to more specific with increases in depth in the matrix.

FIG. 7 is a flow diagram of operation of the sister site server of one embodiment of the invention. A determination is made if the keypress event has been received at decision block 702. If the keypress event has been received, a determination is made if the matrix has reached maximum depth at decision block 704. If the matrix has not reached the maximum depth, a matrix layer corresponding to the keypress is sent at functional block 706. Such matrix layers may or may not include content in cells with navigation choices. If the matrix has reached maximum depth for that navigation path, a content layer corresponding to the keypress event is sent to the client node at functional block 708. A content layer may or may not include matrix cells in addition to the content. New ads are sent to the client node at functional block 710. The system then awaits the next keypress event from a client node.

FIG. 8 is a diagram of the display of a graphical user interface of one embodiment of the invention. The screen is divided into a plurality of cells. In this embodiment, there are

fifteen cells that represent navigation options and one messaging cell for displaying messages from the server, the progress or status bar, and a title block. The cells can further be subdivided between the digit keys 1-9 keys which, in this embodiment, represent the primary set of navigation options and the keys designated by letters A-C which represent secondary navigation options and *, 0, and # keys that may be additional navigation options or provide specialized functions. For example, the * key may return the user to the server home site, thereby leaving matrix navigation. The ABC cells will typically hold advertising, and selecting one of those cells will generate a matrix layer with primary navigation cells directed to that advertiser or the product line being advertised. While the interface is designed to be fully accessible with minimal key strokes from a key pad, it is also within the scope and contemplation of the invention to permit selection with a mouse or other pointer device.

FIGS. 9a-d are example sister site matrix pages. In FIG. 9a, an advertising cell 900 is the focus region of the displayed image. Ten advertisements are displayed within the regions. The first advertisement 902 is highlighted. From this matrix page, the * returns a user to the amazon.com home page. The # reveals the contents of a user's shopping cart. In FIG. 9b, the contents of the focus window have been enlarged (zoomed) such that only four advertisements are displayed in ad cell 900. The no links/advertisements are highlighted. In FIG. 9c, advertisement 902 is again highlighted. This may occur, for example, by a user pressing a scroll key from FIG. 9b. In FIG. 9d, a user has pressed a scroll key several times from FIG. 9c. Thus, advertisement 902 has scrolled out of view and advertisement 904 is highlighted. While in this example, ten advertisements were present, the number of links within such a cell may be arbitrarily large. In the shown embodiment, scrolling through the links in the focus cell and scaling the focus cell content does not effect the user's view of the remaining cells.

FIGS. 10a-g are a series of matrix layers displayed during an exemplary navigation using one embodiment of the invention. In this example, navigation begins at the Shopping and Products matrix layer and shown in FIG. 10a. A selection of 5 on the 10a matrix layer yields an Electronics matrix layer shown in FIG. 10b.

Selecting 1 on the keypad when the matrix layer of 10b is displayed yields the Audio matrix layer of FIG. 10c. By selecting an 8 on the keypad when 10c is displayed, the system displays a Receivers matrix layer of FIG. 10d, which breaks down receivers into price categories and also provides the option of navigating, in this embodiment, into Consumer Reports industry reports related to receivers. Notably, in FIG. 10d, the number of primary navigation options is reduced to 4. Thus, it is not necessary that all layers of the matrix have the same number of cells, nor is it required that all cells have the same size. A user can select Stereo Only by pressing 1 on the keypad, which yields a stereo only matrix layer shown in FIG. 10e.

In one embodiment of the invention, the products are ordered based on some ranking system, such as Consumer Reports. Thus, for example, in FIG. 10e, Technics received the highest ranking of receivers in the selected category from Consumer Reports. It is expected that for any particular product class, potential purchasers are likely to only be interested in the top several products within that class, not for example, the 15th best receiver in the \$150-\$290 range. However, it is within the scope and contemplation of the invention to permit a “more” option which allows a user to get a set of the next most highly ranked products and possibly unranked products as well. It is expected that supplying product options in a

user-friendly ranked order will encourage users to be more willing to conduct e-commerce.

By selecting a **1** on the keypad when matrix layer **10e** is displayed, a user reaches the matrix layer of FIG. **10f**, as well as reaching the maximum depth for that navigation path. Thus, pressing **1** on the keypad in response to matrix layer **10f** does not move the user deeper into the multi-dimensional matrix, and content is displayed in cell **1** indicating the model, price, picture, and possibly other information about the Technics product. Cell **1** is also larger than the other cells.

Other navigation options are provided in additional matrix cells surrounding cell **1** and its content. The additional cells represent navigation paths that have not reached their maximum depth. For example, by pressing a **3**, one would get to a features of the Technics product content layer. Such screen would display features of the Technics system. The various navigation paths typically have a maximum depth at which content is displayed. However, reaching the maximum depth of a particular navigation path does not indicate that another navigation path may not have yet a deeper matrix layer. For example, while the maximum depth of the navigation path corresponded to cell **1** has been reached in FIG. **10f**, selecting a **9** on the keypad will move a user to a Technics purchase matrix layer, shown in FIG. **10g**. By selecting digits on the keypad, a user can move between fields to fill out a purchase form which, as discussed above, is one example of a matrix layer including composition cells. In some embodiments, the form can be filled in using keyboard input. In other embodiments, the speech to text capabilities of the terminal will permit the user to fill out the electronic purchase form orally.

FIG. **11** shows a history window overlying a navigation matrix. The history window would appear if the history button on the keypad were actuated. By using the up/down arrow key on the keypad, the user may then select a prior matrix to jump to directly without moving backwards or forwards iteratively.

FIGS. **12a** and **b** are an example matrix after a selection of **0** from the main menu screen, which allows one to conduct a search through cell **1**. On this figure, advertisements for Jaguar appear in the ABC cells. In one embodiment of the invention, the ABC designation appears initially (as shown in FIG. **12a**) when the screen is first refreshed and then fades away to reveal solely the advertisement in each of those cells (as shown in FIG. **12b**). In this example, pressing an **A** on the keypad would take the user to a matrix reflecting company information about Jaguar. Pressing **B** would take the user to a matrix for the virtual showroom, and **C** would take the user to a purchase screen for the advertised item.

In some cases, the advertising cells are merged as a single cell showing a single advertisement and permitting navigation to only a single matrix layer therefrom. In one embodiment, the background can be an advertisement. This is also shown in FIGS. **12a** and **b**. Significantly, the advertisement can be targeted by modifying the ad responsive to the apparent navigation path of the user. This leaves the potential of showing the user an advertisement for a product or service more likely to be of interest. For example, when a user selects Electronics in the example of FIGS. **10a-g**, the next screen may have as background an advertisement, e.g. for Circuit City.

FIG. **13** shows the e-mail creation screen for one embodiment of the invention. This would be reached by pressing **3** on the keypad when the matrix layer of FIG. **9d** is displayed. Again, all e-mail functions other than actually entering the text and the address can be performed using the simple inter-

face with numerical digits and the letters ABC corresponding to inbox, the outbox, and the sent features of standard e-mail, respectively.

FIG. **14** shows an alternative matrix page of one embodiment of the invention. In this embodiment, the matrix occupies only a portion of the screen real estate. The remaining real estate may be occupied by content, a zoom of the focus cell, or advertising.

In the foregoing specification, the invention has been described with reference to specific embodiments thereof. It will, however, be evident that various modifications and changes can be made thereto without departing from the broader spirit and scope of the invention as set forth in the appended claims. The specification and drawings are, accordingly, to be regarded in an illustrative rather than a restrictive sense. Therefore, the scope of the invention should be limited only by the appended claims.

What is claimed:

1. A method of navigating the Internet, comprising:
 - displaying on-line content accessed via the Internet, the on-line content reformatted from a webpage in a hypertext markup language (HTML) format into an extensible markup language (XML) format to generate a sister site, the sister site including a portion or a whole of content of the web page reformatted to be displayed and navigable through a simplified navigation interface on any one of a television, web appliance, console device, handheld device, wireless device or cellular phone, the simplified navigation interface displayed in a form of a two-dimensional layer of cells from a plurality of layers and a plurality of cells, the two-dimensional layer in a form of a navigation matrix, each cell is a division of a screen and exclusive to a separate single navigation option associated with a specific unique input, the on-line content formatted to be displayed in one or more of the plurality of cells and formatted to be selected for navigation by one or more of the unique inputs, navigation options to change between layers of the simplified navigation interface from general to more specific in each deeper layer;
 - receiving a user selection of one of the navigation options; forwarding the selected navigation option across the internet to a server providing the simplified navigation interface;
 - receiving a next deeper navigation layer of the simplified navigation interface corresponding to the selected navigation option; and
 - manipulating a region of the screen for viewing and zooming and/or scrolling of the displayed on-line content.
2. The method of claim 1, further comprising:
 - displaying one or more advertisements on the screen;
 - receiving a user selection of a displayed advertisement; and
 - displaying second content accessed via the Internet, wherein the second content is associated with the selected advertisement, and
 - wherein the second content accessed via the Internet is formatted for navigation with the unique inputs.
3. The method of claim 1, wherein the on-line content is selected based, at least in part, on a navigation path of a user.
4. The method of claim 1, wherein the user selection of one of the navigation options is received any one of a remote control, a pointer device, a keypad, and a keyboard.
5. The method of claim 1, wherein a wireless Internet appliance comprises a voice recognition system, the method further comprising receiving one or more navigation input selections through the voice recognition system.

11

6. The method of claim 1, wherein the screen includes individual regions adapted to be brought into focus and further adapted such that the on-line content can be manipulated within a selected one of the regions.

7. The method of claim 6, further comprising tabbing to focus on different one of the regions.

8. The method of claim 6, wherein the focused one of the regions is adapted to be zoomed and/or scrolled independently of other ones of the regions.

9. A method comprising:

displaying a first advertisement, the displaying of the first advertisement being via an internet and through a simplified navigation interface, the simplified navigation interface presenting advertisements and content through a plurality of layers and a plurality of cells, the simplified navigation interface displayed in a form of a two-dimensional layer of cells from the plurality of layers and the plurality of cells, the two-dimensional layer in a form of a navigation matrix, each cell in the navigation matrix associated with a specific unique input, each cell is a division of a screen and exclusive to a separate single navigation option, the first advertisement formatted for display in one of the plurality of cells and formatted to be selected for navigation by one of the unique inputs, navigation options to change between layers of the simplified navigation interface from general to more specific in each deeper layer;

displaying a first content via the internet and through the simplified navigation interface, the first content displayed in one or more of the plurality of cells, the first content reformatted from a web page in a hypertext markup language (HTML) format into an extensible markup language (XML) format to generate a sister site to be displayed and navigable through the simplified navigation interface, the sister site including a portion or a whole of content of the web page reformatted to be navigable by unique inputs through the simplified navigation interface on any one of a television, web appliance, console device, handheld device, wireless device or cellular phone;

receiving a first input, the first input received as the specific unique input that is uniquely coupled with an associated cell in the navigation matrix;

forwarding the first input across the internet to a server providing the simplified navigation interface;

receiving a next deeper navigation layer of the simplified navigation interface in response to receiving the first input; and

manipulating a selected region of the screen for viewing and zooming and/or scrolling of the displayed on-line content.

10. The method of claim 9, further comprising: customizing the display of the simplified navigation interface based on a navigation path of the user.

11. The method of claim 9, wherein the first input selects a primary navigation option.

12. The method of claim 9, further comprising: displaying the first content simultaneous with the first advertisement.

13. The method of claim 9, wherein the first input is received from any one of a remote control, a pointer device, a keypad, and a keyboard.

14. The method of claim 9, further comprising:

displaying a second advertisement in the simplified navigation interface, the second advertisement not displayed in a cell or matrix.

12

15. The method of claim 14, further comprising: displaying the simplified navigation interface as an overlay over the second advertisement.

16. The method of claim 9, wherein the first content includes one or more of audio content and video content from the web page.

17. The method of claim 9, further comprising: receiving navigation input selections for the simplified navigation interface from a voice recognition system.

18. The method of claim 9, further comprising: maintaining a database of sister site web pages by a content partner.

19. The method of claim 9, further comprising: accepting an alphanumeric value as the first input to indicate selection of a corresponding first cell, the first cell including a display of the alphanumeric value.

20. The method of claim 9, wherein the simplified navigation interface includes a search form.

21. The method of claim 9, wherein the simplified navigation interface includes an email form.

22. The method of claim 9, further comprising: displaying a purchasing interface in response to receiving the first input.

23. The method of claim 9, wherein the simplified navigation interface is not presented through a standard web browser.

24. The method of claim 9, further comprising: displaying a third advertisement embedded within the online content, the third advertisement corresponding to a third navigation option.

25. A machine readable medium having instructions stored therein, which when executed cause a machine to perform a set of operations comprising:

displaying a first advertisement, the displaying of the first advertisement being via an internet and through a simplified navigation interface, the simplified navigation interface presenting advertisements and content through a plurality of layers and a plurality of cells, the simplified navigation interface displayed in a form of a two-dimensional layer of cells from the plurality of layers and the plurality of cells, the two-dimensional layer in a form of a navigation matrix, each cell in the navigation matrix associated with a specific unique input, each cell is a division of a screen and exclusive to a separate single navigation option, the first advertisement formatted for display in one of the plurality of cells and formatted to be selected for navigation by one of the unique inputs, navigation options to change between layers of the simplified navigation interface from general to more specific in each deeper layer;

displaying a first content via the internet and through the simplified navigation interface, the first content displayed in one or more of the plurality of cells, the first content reformatted from a web page in a hypertext markup language (HTML) format into an extensible markup language (XML) format to generate a sister site to be displayed and navigable through the simplified navigation interface, the sister site including a portion or a whole of content of the web page reformatted to be navigable by unique inputs through the simplified navigation interface on any one of a television, web appliance, console device, handheld device, wireless device or cellular phone;

receiving a first input, the first input received as the specific unique input that is uniquely coupled with an associated cell in the navigation matrix;

13

forwarding the first input across the internet to a server providing the simplified navigation interface; receiving a next deeper navigation layer of the simplified navigation interface in response to receiving the first input; and manipulating a selected region of the screen for viewing and zooming and/or scrolling of the displayed on-line content.

26. The machine readable medium of claim 25, having further instructions stored therein, which when executed cause the machine to perform further operations, comprising: customizing the display of the simplified navigation interface based on a navigation path of the user.

27. The machine readable medium of claim 25, wherein the first input selects a primary navigation option.

28. The machine readable medium of claim 25, having further instructions stored therein, which when executed cause the machine to perform further operations, comprising: displaying the first content simultaneous with the first advertisement.

29. The machine readable medium of claim 25, wherein the first input is received from any one of a remote control, a pointer device, a keypad, and a keyboard.

30. The machine readable medium of claim 25, having further instructions stored therein, which when executed cause the machine to perform further operations, comprising: displaying a second advertisement in the simplified navigation interface, the second advertisement not displayed in a cell or matrix.

31. The machine readable medium of claim 30, having further instructions stored therein, which when executed cause the machine to perform further operations, comprising: displaying the simplified navigation interface as an overlay over the second advertisement.

32. The machine readable medium of claim 25, wherein the first content includes one or more of audio content and video content from the web page.

33. The machine readable medium of claim 25, having further instructions stored therein, which when executed cause the machine to perform further operations, comprising: receiving navigation input selections for the simplified navigation interface from a voice recognition system.

34. The machine readable medium of claim 25, the machine readable medium further comprising: accepting an alphanumeric value as the first input to indicate selection of a corresponding first cell, the first cell including a display of the alphanumeric value.

35. The machine readable medium of claim 25, wherein the simplified navigation interface includes a search form.

36. The machine readable medium of claim 25, wherein the simplified navigation interface includes an email form.

37. The machine readable medium of claim 25, having further instructions stored therein, which when executed cause the machine to perform further operations, comprising: displaying a purchasing interface in response to receiving the first input.

38. The machine readable medium of claim 25, wherein the simplified navigation interface is not presented through a standard web browser.

39. The machine readable medium of claim 25, having further instructions stored therein, which when executed cause the machine to perform further operations, comprising: displaying a third advertisement embedded within the on-line content, the third advertisement corresponding to a third navigation option.

40. The method of claim 1, wherein at least some of the plurality of cells correspond to primary navigation options.

14

41. The method of claim 1, further comprising using a pointer device to select one or more of the plurality of cells and/or to manipulate the screen.

42. The method of claim 1, further comprising: maintaining a database of sister site webpages by a content partner.

43. The method of claim 1, further comprising: displaying the on-line content concurrently with one or more advertisements.

44. The method of claim 43, further comprising: displaying the simplified navigation interface as an overlay over the one or more advertisements.

45. The method of claim 1, further comprising: accepting an alphanumeric value as the user selection of the first navigation option, the first navigation option corresponding to a cell including a display of the alphanumeric value.

46. The method of claim 1, wherein the simplified navigation interface includes a search form.

47. The method of claim 1, wherein the simplified navigation interface includes an email form.

48. The method of claim 1, further comprising: displaying a purchasing interface in response to receiving the first navigation option.

49. The method of claim 1, wherein the simplified navigation interface is not presented through a standard web browser.

50. The method of claim 9, wherein the screen includes individual regions adapted to be brought into focus and further adapted such that the on-line content can be manipulated within a selected one of the regions.

51. The method of claim 50, further comprising tabbing to focus on different one of the regions.

52. The method of claim 50, wherein the focused one of the regions is adapted to be zoomed and/or scrolled independently of other ones of the regions.

53. The method of claim 9, further comprising using a pointer device to select one or more of the plurality of cells and/or to manipulate the screen.

54. The machine readable medium of claim 25, wherein the screen includes individual regions adapted to be brought into focus and further adapted such that the on-line content can be manipulated within a selected one of the regions.

55. The machine readable medium of claim 54, having further instructions stored therein, which when executed cause the machine to perform further operations, comprising: tabbing to focus on different one of the regions.

56. The machine readable medium of claim 54, wherein the focused one of the regions is adapted to be zoomed and/or scrolled independently of other ones of the regions.

57. The machine readable medium of claim 25, having further instructions stored therein, which when executed cause the machine to perform further operations, comprising: using a pointer device to select one or more of the plurality of cells and/or to manipulate the screen.

58. A machine readable medium having instructions stored therein, which when executed cause a machine to perform a set of operations comprising:

displaying on-line content accessed via the Internet, the on-line content reformatted from a webpage in a hypertext markup language (HTML) format into an extensible markup language (XML) format to generate a sister site, the sister site including a portion or a whole of content of the web page reformatted to be displayed and navigable through a simplified navigation interface on any one of a television, web appliance, console device, handheld device, wireless device or cellular phone, the simplified navigation interface displayed in a form of a two-dimensional layer of cells from a plurality of layers and a plurality of cells, the two-dimensional layer in a form of

15

a navigation matrix, each cell is a division of a screen and exclusive to a separate single navigation option associated with a specific unique input, the on-line content formatted to be displayed in one or more of the plurality of cells and formatted to be selected for navigation by one or more of the unique inputs, navigation options to change between layers of the simplified navigation interface from general to more specific in each deeper layer;

receiving a user selection of one of the navigation options; forwarding the selected navigation option across the internet to a server providing the simplified navigation interface;

receiving a next deeper navigation layer of the simplified navigation interface corresponding to the selected navigation option; and

manipulating a region of the screen for viewing and zooming and/or scrolling of the displayed on-line content.

59. The machine readable medium of claim 58, having further instructions stored therein, which when executed cause the machine to perform further operations, comprising: displaying one or more advertisements on the screen; receiving a user selection of a displayed advertisement; and displaying second content accessed via the Internet, wherein the second content is associated with the selected advertisement, and wherein the second content accessed via the Internet is formatted for navigation with the unique inputs.

60. The machine readable medium of claim 58, wherein the on-line content is selected based, at least in part, on a navigation path of a user.

61. The machine readable medium of claim 58, wherein the user selection of one of the navigation options is received from any one of a remote control, a pointer device, a keypad, and a keyboard.

62. The machine readable medium of claim 58, having further instructions stored therein, which when executed cause the machine to perform further operations, comprising: receiving one or more navigation input selections through a voice recognition system.

63. The machine readable medium of claim 58, wherein the screen includes individual regions adapted to be brought into focus and further adapted such that the on-line content can be manipulated within a selected one of the regions.

64. The machine readable medium of claim 63, having further instructions stored therein, which when executed cause the machine to perform further operations, comprising: tabbing to focus on different one of the regions.

16

65. The machine readable medium of claim 63, wherein the focused one of the regions is adapted to be zoomed and/or scrolled independently of other ones of the regions.

66. The machine readable medium of claim 58, wherein at least some of the plurality of cells correspond to primary navigation options.

67. The machine readable medium of claim 58, having further instructions stored therein, which when executed cause the machine to perform further operations, comprising: using a pointer device to select one or more of the plurality of cells and/or to manipulate the screen.

68. The machine readable medium of claim 58, having further instructions stored therein, which when executed cause the machine to perform further operations, comprising: displaying the on-line content concurrently with one or more advertisements.

69. The machine readable medium of claim 68, having further instructions stored therein, which when executed cause the machine to perform further operations, comprising: displaying the simplified navigation interface as an overlay over the one or more advertisements.

70. The machine readable medium of claim 58, the machine readable medium further comprising: accepting an alphanumeric value to indicate selection of the first navigation option, the first navigation option corresponding to a cell including a display of the alphanumeric value.

71. The machine readable medium of claim 58, wherein the simplified navigation interface includes a search form.

72. The machine readable medium of claim 58, wherein the simplified navigation interface includes an email form.

73. The machine readable medium of claim 58, having further instructions stored therein, which when executed cause the machine to perform further operations, comprising: displaying a purchasing interface in response to receiving the selection of the first navigation option.

74. The machine readable medium of claim 58, wherein the simplified navigation interface is not presented through a standard web browser.

75. The method of claim 1, wherein the on-line content includes one or more of audio content and video content from the web page.

76. The machine readable medium of claim 58, wherein the on-line content includes one or more of audio content and video content from the web page.

* * * * *