

Exhibit “D6”



UNITED STATES PATENT AND TRADEMARK OFFICE

UNITED STATES DEPARTMENT OF COMMERCE
United States Patent and Trademark Office
Address: COMMISSIONER FOR PATENTS
P.O. Box 1450
Alexandria, Virginia 22313-1450
www.uspto.gov

APPLICATION NO.	FILING DATE	FIRST NAMED INVENTOR	ATTORNEY DOCKET NO.	CONFIRMATION NO.
90/010,831	01/22/2010	5,490,216	2914.001REX0	2214
26111	7590	03/07/2011	EXAMINER	
STERNE, KESSLER, GOLDSTEIN & FOX P.L.L.C. 1100 NEW YORK AVENUE, N.W. WASHINGTON, DC 20005			ART UNIT	PAPER NUMBER

DATE MAILED: 03/07/2011

Please find below and/or attached an Office communication concerning this application or proceeding.



DO NOT USE IN PALM PRINTER

(THIRD PARTY REQUESTER'S CORRESPONDENCE ADDRESS)

Kyle Rinehart
Klarquist Sparkman, LLP
One World Trade Center, Suite 1600
121 S.W. Salmon Street
Portland, OR 97204

MAILED
MAR 07 2011
CENTRAL REEXAMINATION UNIT

EX PARTE REEXAMINATION COMMUNICATION TRANSMITTAL FORM

REEXAMINATION CONTROL NO. 90/010,831.

PATENT NO. 5,490,216.

ART UNIT 3992.

Enclosed is a copy of the latest communication from the United States Patent and Trademark Office in the above identified *ex parte* reexamination proceeding (37 CFR 1.550(f)).

Where this copy is supplied after the reply by requester, 37 CFR 1.535, or the time for filing a reply has passed, no submission on behalf of the *ex parte* reexamination requester will be acknowledged or considered (37 CFR 1.550(g)).

Ex Parte Reexamination Interview Summary	Control No. 90/010,831	Patent Under Reexamination 5,490,216	
	Examiner MATTHEW HENEGHAN	Art Unit 3992	

All participants (USPTO personnel, patent owner, patent owner's representative):

- (1) MATTHEW HENEGHAN (3) Mary Steelman
(2) Jessica Harrison (4) 7 Others (see Exhibit)

Date of Interview: 03 March 2011

Type: a) Telephonic b) Video Conference
c) Personal (copy given to: 1) patent owner 2) patent owner's representative)

Exhibit shown or demonstration conducted: d) Yes e) No.
If Yes, brief description: Powerpoint Presentation

Agreement with respect to the claims f) was reached. g) was not reached. h) N/A.
Any other agreement(s) are set forth below under "Description of the general nature of what was agreed to..."

Claim(s) discussed: 1-20.

Identification of prior art discussed: Hellman, Grundy.

Description of the general nature of what was agreed to if an agreement was reached, or any other comments:
The claim rejections and the previously submitted affidavits were discussed. No agreement was reached. See attachment.

(A fuller description, if necessary, and a copy of the amendments which the examiner agreed would render the claims patentable, if available, must be attached. Also, where no copy of the amendments that would render the claims patentable is available, a summary thereof must be attached.)

A FORMAL WRITTEN RESPONSE TO THE LAST OFFICE ACTION MUST INCLUDE PATENT OWNER'S STATEMENT OF THE SUBSTANCE OF THE INTERVIEW. (See MPEP § 2281). IF A RESPONSE TO THE LAST OFFICE ACTION HAS ALREADY BEEN FILED, THEN PATENT OWNER IS GIVEN **ONE MONTH** FROM THIS INTERVIEW DATE TO PROVIDE THE MANDATORY STATEMENT OF THE SUBSTANCE OF THE INTERVIEW (37 CFR 1.560(b)). THE REQUIREMENT FOR PATENT OWNER'S STATEMENT CAN NOT BE WAIVED. **EXTENSIONS OF TIME ARE GOVERNED BY 37 CFR 1.550(c).**

		/Matthew Heneghan/ Primary Examiner USPTO AU 3992
cc: Requester (if third party requester)		

Applicant Initiated Interview Request Form

Application No.: 90/010,831 First Named Applicant: Frederic B. RICHARDSON, III
 Examiner: HENEGHAN, Matthew E. Art Unit: 3992 Status of Application: Non-Final

Tentative Participants:

- (1) Matthew E. Hencghan, Jessica Harrison (2) Robert Sterne /28,912, Jon Wright /50,720
 (3) B. Davis, W. Rosenblatt, S. Burdick (4) R. Molitors /66,726, J. Etheridge /37,614

Proposed Date of Interview: March 3, 2011 Proposed Time: 1:00 PM (AM/PM)

Type of Interview Requested:

- (1) Telephonic (2) Personal (3) Video Conference

Exhibit To Be Shown or Demonstrated: YES NO

If yes, provide brief description: Interview points regarding non-final office action

Issues To Be Discussed

Issues (Rej., Obj., etc)	Claims/ Fig. #s	Prior Art	Discussed	Agreed	Not Agreed
(1) <u>Rejection</u>	<u>Indep. Claims</u>	<u>Hellman</u>	<input type="checkbox"/>	<input type="checkbox"/>	<input checked="" type="checkbox"/>
(2) _____	_____	<u>Grundy</u>	<input type="checkbox"/>	<input type="checkbox"/>	<input checked="" type="checkbox"/>
(3) _____	_____	_____	<input type="checkbox"/>	<input type="checkbox"/>	<input type="checkbox"/>
(4) _____	_____	_____	<input type="checkbox"/>	<input type="checkbox"/>	<input type="checkbox"/>

Continuation Sheet Attached Proposed Amendment or Arguments Attached

Brief Description of Arguments to be Presented: _____

See 1 in Addendum

An interview was conducted on the above-identified application on ~~November 17, 2010~~ March 3, 2011

NOTE: This form should be completed and filed by applicant in advance of the interview (see MPEP § 713.01). If this form is signed by a registered practitioner not of record, the Office will accept this as an indication that he or she is authorized to conduct an interview on behalf of the principal (37 CFR 1.32(a)(3)) pursuant to 37 CFR 1.34. This is not a power of attorney to any above named practitioner. See the Instruction Sheet for this form, which is incorporated by reference. By signing this form, applicant or practitioner is certifying that he or she has read the Instruction Sheet. After the interview is conducted, applicant is advised to file a statement of the substance of this interview (37 CFR 1.133(b)) as soon as possible. This application will not be delayed from issue because of applicant's failure to submit a written record of this interview.

Jon E. Wright Jon E. Wright 50,720
 Applicant/Applicant's Representative Signature

M. Hencghan
 Examiner/SPE Signature

for Robert G. Sterne
 Typed/Printed Name of Applicant or Representative

28,912
 Registration Number, if applicable

This collection of information is required by 37 CFR 1.133. The information is required to obtain or retain a benefit by the public which is to file (and by the USPTO to process) an application. Confidentiality is governed by 38 U.S.C. 122 and 37 CFR 1.11 and 1.14. This collection is estimated to take 24 minutes to complete, including gathering, preparing, and submitting the completed application form to the USPTO. Time will vary depending upon the individual case. Any comments on the amount of time you require to complete this form and/or suggestions for reducing this burden, should be sent to the Chief Information Officer, U.S. Patent and Trademark Office, U.S. Department of Commerce, P.O. Box 1450, Alexandria, VA 22313-1450. Do NOT send forms or company forms.

JON E. WRIGHT
DIRECTOR
(202) 772-8651
JWRIGHT@SKGF.COM



Re-Exam
**Sterne Kessler
Goldstein Fox**
ATTORNEYS AT LAW

March 18, 2011

Commissioner for Patents
PO Box 1450
Alexandria, VA 22313-1450

Confirmation No. 2214
Art Unit 3992
Mail Stop Ex Parte Reexam

Re: Reexamination of U.S. Patent No. 5,490,216
Control No. 90/010,831; Filing Date: January 22, 2010
For: **System for Software Registration**
Inventor: Frederic B. Richardson, III
Our Ref: 2914.001REX0

Sir:

Transmitted herewith for appropriate action are the following documents:

1. Reply to Non-Final Office Action in Ex Parte Reexamination;
2. Exhibits A through E; including: Joint Appendix Excerpts of *Uniloc USA, Inc. v. Microsoft Corp.*, --- F.3d ---, 2011 WL 9738 (Fed. Cir. 2011) as Exhibit A; a Letter from Bill Gates as Exhibit B; Business Software Alliance Data as Exhibit C; a Rule 132 Supplemental Declaration of William R. Rosenblatt as Exhibit D; and a Rule 132 Declaration of Dr. Udo W. Pooch as Exhibit E;
3. Certification of Service of Reply to Second Non-Final Office Action in Ex Parte Reexamination pursuant to 37 C.F.R. § 1.550(f); and
4. Return postcard.

It is respectfully requested that the attached postcard be stamped with the date of filing of these documents, and that it be returned to our courier.

In the event that extensions of time are necessary to prevent abandonment of this reexamination, then such extensions of time are hereby petitioned.

Commissioner for Patents
March 18, 2011
Page 2

The U.S. Patent and Trademark Office is hereby authorized to charge any fee deficiency, or credit any overpayment, to our Deposit Account No. 19-0036.

Respectfully submitted,

STERNE, KESSLER, GOLDSTEIN & FOX P.L.L.C.

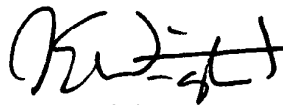

Jon E. Wright
Attorney for Applicants
Registration No. 50,720

JEW/RWM/kc
Enclosures
1288899_1.DOC

IN THE UNITED STATES PATENT AND TRADEMARK OFFICE



In re reexam of: U.S. Patent 5,490,216 to
RICHARDSON, III
Reexam Control No.: 90/010,831
Filed: January 22, 2010
For: System for Software Registration

Confirmation No.: 2214
Art Unit: 3992
Examiner: HENEGHAN, Matthew E.
Atty. Docket: 2914.001REX0

Response to Non-Final Office Action Dated January 18, 2011

Mail Stop *Ex Parte* Reexamination

Central Reexamination Unit
Commissioner for Patents
PO Box 1450
Alexandria, VA 22313-1450

Sir:

Patent Owner hereby replies to the Office Action in the above-captioned *ex parte* reexamination dated January 18, 2011. The due date for reply is March 18, 2011. The Status of the Claims is reflected in the listing of claims, which begins on page 4 of this paper. Remarks begin on page 9 of this paper. It is not believed that any fees are required with this response. But if any fees are necessary to prevent abandonment of this reexamination, then such fees are hereby authorized to be charged to our Deposit Account No. 19-0036.

UNI075188

TABLE OF CONTENTS

LISTING OF CLAIMS..... 4

REMARKS..... 9

I. INTRODUCTION 10

 A. The Rejections in the Second Action Are All Based on a Legally Erroneous Claim Interpretation and a Factually Erroneous Analysis of Hellman..... 10

 B. The Proposed Modification of Hellman in View of Grundy is Legally Impermissible. 12

 C. The Office Improperly Dismissed Much of Uniloc’s Rule 132 Declaratory Evidence. 13

 D. The Office Has Taken Several Inconsistent Positions in This Reexamination. 14

II. OVERVIEW OF REEXAM PROSECUTION..... 15

 A. First Non-Final Office Action 16

 B. Second Non-Final Action. 17

III. RESPONSE TO THE ADOPTED SUBSTANTIVE CLAIM REJECTIONS 18

 A. Independent Claims 19 and 20 Are Not Anticipated by Hellman 18

 B. Claims 1, 7-11, 19 and 20 Are Not Obvious Over Hellman Alone..... 22

 C. Claims 1-20 Are Not Obvious Over Hellman In View of Grundy..... 23

 1. Basis for the proposed combination 23

 2. The Examiner mischaracterized Hellman in supporting the purported motivation to combine. 25

 3. Examiner mischaracterized Grundy’s use of checksums. 27

 4. The proposed combination would fundamentally change the operation of Hellman in a way Hellman expressly forbids. 28

 5. Even with proposed modification, Hellman still does not generate a licensee unique ID. 31

 D. Dependent Claims 2, 12 and 17 Are Also Not Obvious Over Hellman In View of Grundy..... 32

 1. The Examiner mischaracterized Grundy in supporting the proposed motivation to combine. 32

 2. The Examiner has again mischaracterized Grundy’s use of checksums. 33

IV. OBJECTIVE INDICIA OF NON-OBVIOUSNESS 34

 A. Uniloc Has Conclusively Established the Commercial Success of At Least Independent Claim 19..... 36

1. Uniloc has conclusively established a nexus between independent claim 19 and Microsoft’s Product Activation technology..... 36

2. Uniloc has conclusively established the commercial success of Microsoft’s Product Activation technology 37

3. Summary for Commercial Success..... 38

B. The ‘216 Patented Technology Met a Long-Felt Need 38

C. Failure by Others. 40

D. Conclusion with Respect to Objective Indicia of Non-Obviousness..... 41

V. STATUS OF CONCURRENT LITIGATION 41

VI. IMPROPER GRANT OF A SUBSTANTIAL NEW QUESTION OF PATENTABILITY 42

VII. STATEMENT OF THE SUBSTANCE OF THE INTERVIEW 44

CONCLUSION..... 45

Listing of Claims

Original claims 1-20 from U.S. Patent No. 5,490,216 to Richardson (“the ‘216 patent”) are subject to *ex parte* reexamination. No claims are added, cancelled or amended.

1. (Patented) A registration system for licensing execution of digital data in a use mode, said digital data executable on a platform, said system including local licensee unique ID generating means and remote licensee unique ID generating means, said system further including mode switching means operable on said platform which permits use of said digital data in said use mode on said platform only if a licensee unique ID first generated by said local licensee unique ID generating means has matched a licensee unique ID subsequently generated by said remote licensee unique ID generating means; and wherein said remote licensee unique ID generating means comprises software executed on a platform which includes the algorithm utilized by said local licensee unique ID generating means to produce said licensee unique ID.

2. (Patented) The system of claim 1, wherein said local licensee unique ID generating means generates said local licensee unique ID by execution of a registration algorithm which combines information in accordance with said algorithm, said information uniquely descriptive of an intending licensee of said digital data to be executed in said use mode.

3. (Patented) The system of claim 2, wherein said mode switching means permits operation of said digital data in said use mode in subsequent execution of said digital data only if said licensee unique ID generated by said local licensee unique ID generating means has not changed.

4. (Patented) The system of claim 3, wherein said local licensee unique ID generating means comprises part of said digital data when executed on said platform.

5. (Patented) The system of claim 4, wherein said mode switching means comprises part of said digital data when executed on said platform.

6. (Patented) The system of claim 5, wherein the information utilized by said local licensee unique ID generating means to produce said licensee unique ID comprises prospective licensee details including at least one of payment details, contact details and name.

7. (Patented) The system of claim 1, said system further including platform unique ID generating means, wherein said mode switching means will permit said digital data to run in said use mode in subsequent execution of said digital data on said platform only if said platform unique ID has not changed.

8. (Patented) The system of claim 7, wherein said platform unique ID generating means comprises part of said digital data when executed on said platform.

9. (Patented) The system of claim 8, wherein said platform unique ID generating means utilizes hard disc or other platform information to determine said platform unique ID.

10. (Patented) The system of claim 1, wherein said platform comprises a computer operating system environment.

11. (Patented) The system of claim 10, wherein said digital data comprises a software program adapted to run under said operating system environment.

12. (Patented) A registration system attachable to software to be protected, said registration system generating a security key from information input to said software which uniquely identifies an intended registered user of said software on a computer on which said

software is to be installed; and wherein said registration system is replicated at a registration authority and used for the purposes of checking by the registration authority that the information unique to the user is correctly entered at the time that the security key is generated by the registration system.

13. (Patented) The registration system of claim 12, wherein said security key is generated by a registration number algorithm.

14. (Patented) The registration system of claim 13, wherein said registration number algorithm combines information entered by a prospective registered user unique to that user with a serial number generated from information provided by the environment in which the software to be protected is to run.

15. (Patented) The registration system of claim 12, wherein said registration system checks at the time of boot of said software as to whether it is a first boot of the software to be protected or a subsequent boot, and, if a subsequent boot is detected, then environment and user details are compared to determine whether the program reverts to a demonstration mode and a new user registration procedure is to commence or a full version run.

16. (Patented) The registration system of claim 15, wherein said environment details comprise at least one element which is not user-configurable on the platform.

17. (Patented) A method of control of distribution of software, said method comprising providing mode-switching means associated with said software adapted to switch said software between a fully enabled mode and a partly enabled or demonstration mode, said method further comprising providing registration key generating means adapted to generate a registration key which is a function of information unique to an intending user of the

software; said mode-switching means switching said software into fully enabled mode only if an enabling key provided to said mode-switching means by said intending user at the time of registration of said software has matched identically with said registration key; and wherein said enabling key is communicated to said intending user at the time of registration of said software; said enabling key generated by a third party means of operation of a duplicate copy of said registration key generating means.

18. (Patented) The method of claim 17, wherein said registration key is also a function of the environment in which said software is installed.

19. (Patented) A remote registration station incorporating remote licensee unique ID generating means, said station forming part of a registration system for licensing execution of digital data in a use mode, said digital data executable on a platform, said system including local licensee unique ID generating means, said system further including mode switching means operable on said platform which permits use of said digital data in said use mode on said platform only if a licensee unique ID generated by said local licensee unique ID generating means has matched a licensee unique ID generated by said remote licensee unique ID generating means; and wherein said remote licensee unique ID generating means comprises software executed on a platform which includes the algorithm utilized by said local licensee unique ID generating means to produce said licensee unique ID.

20. (Patented) A method of registration of digital data so as to enable execution of said digital data in a use mode, said method comprising an intending licensee operating a registration system for licensing execution of digital data in a use mode, said digital data executable on a platform, said system including local licensee unique ID generating means and remote licensee unique ID generating means, said system further including mode

switching means operable on said platform which permits use of said digital data in said use mode on said platform only if a licensee unique ID generated by said local licensee unique ID generating means has matched a licensee unique ID generated by said remote licensee unique ID generating means; and wherein said remote licensee unique ID generating means comprises software executed on a platform which includes the algorithm utilized by said local licensee unique ID generating means to produce said licensee unique ID.

Remarks

Original claims 1-20 from U.S. Patent No. 5,490,216 to Richardson (“the ‘216 patent”) are subject to *ex parte* reexamination. The reexamination was ordered on April 9, 2010. (Reexam Order.) In the first Office action dated September 28, 2010 (“First Action”), claims 1-20 were rejected solely under 35 U.S.C. § 103(a) over U.S. Patent No. 4,658,093 to Hellman in view of U.S. Patent 5,291,598 to Grundy.¹ (First Action, p. 6.) An in-person interview was conducted on November 17, 2010. The patent owner Uniloc then responded with a timely reply on November 29, 2010 (“Reply”). The Reply was supported by four declarations under 37 C.F.R. § 1.132 (“Rule 132”) from Ravinda Marwaha, Brad Davis, Ric B. Richardson and William R. Rosenblatt.

In response to the Reply, the Office issued a second non-final Office action dated January 18, 2011 (“Second Action”). In the Second Action, claims 1-20 remain rejected as obvious over Hellman in view of Grundy. The Office also added two additional grounds of rejection for certain claims. Specifically, independent claims 19 and 20 now stand rejected under 35 U.S.C. § 102(b) over Hellman, while claims 1, 7-11, 19 and 20 stand rejected under 35 U.S.C. § 103(a) as obvious over Hellman—a single reference § 103 rejection. Uniloc respectfully traverses all three rejections and requests that they be reconsidered and withdrawn.

¹ In the First Action, the Examiner misstated the patent numbers for both Hellman and Grundy. (First Action, p. 4.) Those errors were not corrected in the Second Action. The correct patent numbers are listed above.

I. INTRODUCTION

A. **The Rejections in the Second Action Are All Based on a Legally Erroneous Claim Interpretation and a Factually Erroneous Analysis of Hellman.**

In supporting its new grounds of rejection, the Office in the Second Action has expanded its construction of “licensee unique ID generating means” to encompass an unreasonably broad scope. The new construction reads: “an ID ... created that is *associated with a request* that includes information provided by and specific to a user, such as billing information.” (Second Action, p. 14; emphasis added.) By decoupling the creation of the claimed “licensee unique ID” from any information uniquely associated with an intended licensee, and instead asserting that it need only be “*associated with a request*” that includes user specific information, the Office has impermissibly stretched the claim scope beyond that permitted by the broadest reasonable interpretation standard. *In re Suitco Surface*, 603 F.3d 1255 (Fed. Cir. 2010). This impermissibly broad construction forms the basis for each of the three separate grounds of rejection set forth in the Second Action.

In applying this new construction, the Office asserts that Hellman’s authorization A (or check value C) is “functionally equivalent to the means disclosed in the ‘216 patent.” (Second Action, p. 9.) But this directly conflicts with governing case law for claims recited under 35 U.S.C. § 112(6), which requires identity of function, not equivalent function. *Pennwalt Corp. v. Durand-Wayland, Inc.*, 833 F.2d 931, 934 (Fed. Cir. 1987) (en banc). The Office is required to interpret means-plus function claims in the same manner as the Courts. *In re Donaldson*, 16 F.3d 1189, 1193 (Fed. Cir. 1994). To suggest that “functional equivalence” is the standard for determining whether a reference anticipates a feature claimed under the statutory provisions of § 112(6) is contrary to law.

Regardless of the Office's application of its new construction of "licensee unique ID generating means," the Office has also factually mischaracterized Hellman with respect to that term. Contrary to the Office's interpretation, the BILLING INFORMATION is not associated with authorization A (or check value C). (*See*, Hellman FIG. 2; 6:16-30; 7:6-13; FIG. 7; and 10:14-32.) Nor is any user specific information input to Hellman's cryptographic function generators that generate A and C. (*Id.*) Indeed, Hellman explicitly states that authorization A is not associated with a user, but rather is base unit (*e.g.*, a personal computer) specific. (Hellman, 12:1-9.)

The Federal Circuit came to the same conclusion in a decision rendered two weeks prior to the Second Action when it considered whether the very same Hellman reference anticipated the very same claim limitation in an invalidity charge against the very same patent at issue here. The Federal Circuit stated:

The "user billing information" in [Hellman] is not an input into the hash function and is thus irrelevant in determining whether [Hellman] discloses the "licensee unique ID" and "licensee unique ID generating means" elements of the '216 patent.

Uniloc USA, Inc. v. Microsoft Corp., --- F.3d ---, 2011 WL 9738, *56, n. 3 (Fed. Cir. 2011). While a court's decision that a patent is not invalid is generally not binding on the Office, the situation in this case is unusual. The Office ought to give deference to a Federal Circuit decision where it ruled on the same issue now before the central reexamination unit — whether Hellman anticipates claim 19 of the '216 patent. This is especially true where the claim terms at issue are drafted under § 112(6) and the Office must interpret this term in the same manner as the courts. *In re Donaldson*, 16 F.3d 1189, 1193 (Fed. Cir. 1994).

The Office's legally erroneous interpretation of "licensee unique ID" and factually erroneous interpretation of Hellman together form the basis for all three separate grounds of

rejection set forth in the Second Action. On either basis alone, all three rejections should be reconsidered and withdrawn.

B. The Proposed Modification of Hellman in View of Grundy is Legally Impermissible.

The proposed combination of Hellman and Grundy is legally flawed. First, the Examiner mischaracterized Hellman in supporting the purported motivation to combine Hellman and Grundy. In searching for a motivation to use a simple algorithm in place of Hellman's cryptographic functions, the Examiner mistakenly pointed to a portion of Hellman referring to Hellman's hash function 22.

Second, the Examiner mischaracterized Grundy's use of checksums in supporting the proposed combination. Third, no one skilled in the art would have modified Hellman's cryptographic function generator to include Grundy's checksum algorithms because Grundy's checksums are an entirely different class of algorithm than the cryptographic functions that Hellman unambiguously states are *required* for his invention.

Finally, the proposed modification to Hellman still does not address Hellman's main deficiency that it does not use any information uniquely associated with an intended licensee to generate its authorization A (or check value C). Thus, even with the proposed modification in view of Grundy, Hellman's system still does not generate the claimed "licensee unique ID," which as a matter of law is evidence that the invention is not obvious. MPEP 2143 (Obviousness requires "a finding that the prior art included each element claimed, although not necessarily in a single prior art reference, with the only difference between the claimed invention and the prior art being the lack of actual combination of the elements in a single prior art reference."). Any one of these errors are sufficient to warrant reversal of the § 103 rejection of Hellman in view of Grundy.

Atty. Dkt. No. 2914.001REX0

C. The Office Improperly Dismissed Much of Uniloc's Rule 132 Declaratory Evidence.

The Office also improperly dismissed the majority of Uniloc's Rule 132 evidence proffered in support of its validity positions as "unpersuasive." For example, the Second Action failed to state with any specificity why Rosenblatt's declaratory evidence was not persuasive, as it was required to do by the Office's own rules. MPEP 716.01. General statements such as "the declaration lacks technical validity" or "the evidence is not commensurate in scope with the claims" without explanation supporting such findings are unacceptable. *Id.* The Second Action therefore breached the rules by summarily dismissing Rosenblatt's declaration as consisting "entirely of opinions." Indeed, the Federal Circuit has stated that "we are aware of no reason why opinion evidence relating to a fact issue should not be considered by an examiner." *In re Alton*, 76 F.3d 1168, 1175, n. 10 (Fed. Cir. 1996).

In fact, much of that evidence was relevant and probative to the validity analysis, and conformed to the Office's own standards for declaratory evidence. Opinion on the ultimate legal conclusion is not entitled to any weight, although the underlying basis for the opinion may be given some weight. *In re Chilowsky*, 306 F.2d 908 (CCPA 1962). Although a declarant's opinion on the ultimate legal issue is not evidence in the case, "some weight ought to be given to a persuasively supported statement of one skilled in the art on what was not obvious to him." *In re Lindell*, 385 F.2d 453 (CCPA 1967).

The ultimate determination of patentability must be based on consideration of the entire record by a preponderance of the evidence. *In re Oetiker*, 977 F.2d 1443 (Fed. Cir. 1992). Each piece of rebuttal evidence should not be evaluated for its ability to "knock down" the *prima facie* case. All of the competent rebuttal evidence, taken as whole, should be weighed against the evidence supporting the *prima facie* case. *In re Piasecki*, 745 F.2d

1468 (Fed. Cir. 1984). Expert opinion supported by documentary evidence may be given weight. *In re Carroll*, 601 F.2d 1184 (CCPA 1979). Further, evidence of non-technological nature is pertinent to the conclusion of obviousness. *In re Piasecki*, 745 F.2d 1468, 1473 (Fed. Cir. 1984) (finding that the declarations of those skilled in the art regarding the need for the invention and its reception by the art were improperly discounted by the Board.) Office personnel should avoid giving evidence no weight, except in rare circumstances. *See In re Alton*, 76 F.3d at 1174-75.

Uniloc stands behind the sworn declarations it submitted in support of its response to the First Action. Uniloc requests that the Office reconsider its dismissal of that evidence. Finally, in support of the present response to the Second Action, Uniloc has submitted a supplemental declaration by William Rosenblatt (“Rosenblatt Supp. Dec.”) and a declaration by Dr. Udo Pooch (“Pooch Dec.”).

D. The Office Has Taken Several Inconsistent Positions in This Reexamination.

The rejections under sections 102 and 103 are inconsistent with respect to the interpretation of Hellman. For instance, in the § 102 rejection, the Second Action alleges that Hellman’s authorization A or C is “effectively specific to a licensee” (Second Action, p. 9), while in the § 103 rejection, the Examiner states that “Hellman does not disclose that the information being combined in the algorithm is uniquely descriptive of an intended licensee, but merely the intended licensee’s computer.” (Office Action, p. 15). These statements are contradictory. One implies that Hellman’s authorization is effectively specific to a licensee, while the other acknowledges that it is not.

Uniloc’s consistent position, which as a matter of law has been confirmed by the Federal Circuit, is that the claimed “licensee unique ID” must be “a unique identifier

associated with a licensee.” *Uniloc v. Microsoft*, Case No. 03-440S, slip op. at 21 (D.R.I. 2006). To accomplish this, there must be some input to the means for generating the claimed “licensee unique ID” that characterizes the intended user. Hellman’s cryptographic function generator has no such input and, as the Examiner correctly acknowledged (Second Action, p. 20), its output is solely descriptive of the licensee’s computer. (*See*, Hellman, 6:16 - 7:2.) Therefore, even under a broadest reasonable interpretation standard, Hellman’s cryptographic function generator does not (and cannot) anticipate the claimed “licensee unique ID generating means.” Uniloc’s interpretation is the more reasonable position and should be adopted by the Office as it was by the Federal Circuit.

The Office is also inconsistent in its interpretation of Grundy. In the Reexam Order, the Examiner stated that “[c]hecksums are not unique fields, even if they are at least in part derived from unique data.” (Reexam Order, p. 9.) In the Second Action, the Examiner stated that Grundy’s “unique ID, a registration code, is produced by performing a checksum of the user data component fields.” (Second Action, p. 14.) These two statements are contradictory. The first states that Grundy’s checksums are not unique; the second states that that Grundy’s checksum can produce a unique ID. Uniloc submits that based on the Examiner’s statement in the Order, Grundy’s data validation checksums do not produce a unique ID that could be used by Hellman.

II. Overview of Reexam Prosecution

Uniloc provides below an overview of the prosecution to date in this *ex parte* reexamination.

A. First Non-Final Office Action

In the First Action, the Office attempted to equate Hellman's "cryptographic function generator" to the claimed "licensee unique ID generating means" in the '216 patent. (First Action, p. 6.) It is undisputed that this feature is recited in means-plus-function format under 35 U.S.C. § 112(6). In the First Action, the Office identified the corresponding structure as a hardware summer and recognized that the summer could also be implemented in software. (First Action, p. 5.) But the Office did not explicitly identify the function, as it was required to do, and therefore made no explicit finding regarding identity of function. All the Office did was parenthetically equate the "licensee unique ID generating means" to Hellman's cryptographic function generator. (First Action, p. 6.) It provided no further explanation regarding the claimed function. The only thing missing from Hellman, according to the Office, was the corresponding structure—namely, the summer. For that, the Office inconsistently relied on Grundy's checksum (First Action, p. 7) despite its earlier acknowledgement that "checksums are not unique fields" (Order Granting Reexam, p. 9).

In reply, Uniloc argued that Hellman did not teach the claimed function—that is, generation of the claimed "licensee unique ID" in claims 1, 19 and 20, the "security key" in claim 12, and the "registration key" and "enabling key" in claim 17. The basis for Uniloc's position was that none of the inputs to Hellman's cryptographic function generator included any information that was uniquely associated with the intended licensee; and without such input, it could not generate a "licensee unique ID." (Reply, pp. 17-25.)

Uniloc also argued that Grundy's checksum did not generate "a licensee unique ID" because Grundy's checksum algorithm, by its very nature, destroys any uniqueness. (Reply, pp. 26-28.) Because neither reference disclosed the claimed function—*i.e.*, generation of a

licensee unique ID—Uniloc argued that the combination of references could not render obvious the independent claims. Uniloc set forth its position at the November 17, 2010 in-person interview and properly supported its Reply with Rule 132 declarations.

B. Second Non-Final Action.

In the Second Action, the Office shifted its position and set forth a new claim construction for the “licensee unique ID generating means.” Specifically, the Office is now construing the term “licensee unique ID” to mean “an ID remotely created that is *associated with a request* that includes information provided by and specific to a user, such as billing information.” (Second Action, p. 9; emphasis added.) In applying that construction, the Examiner asserted that Hellman’s authorization A was “effectively specific to the licensee” and was therefore “functionally equivalent to the means disclosed in the ‘216 patent.” (*Id.* at 9.) “Functional equivalence” is not the correct legal standard. *Pennwalt v. Durand-Wayland, Inc.*, 833 F.2d 931, 934 (Fed. Cir. 1987) (en banc). But based on this legally flawed construction, the Office now asserts that Hellman anticipates independent claims 19 and 20 under 35 U.S.C. § 102(b)—a position already rejected by a Federal District Court and affirmed by the Federal Circuit.

The remaining rejections are largely based on the same reasoning. The only difference between the other two rejections, according to the Examiner, appears to be “whether or not the scope of the terms ‘local licensee unique ID generating means’ and ‘remote licensee unique ID generating means’ encompasses implementations that do not include a summer in the algorithm.” (Second Action, pp. 12-13 and 14.) To address that alleged point of uncertainty, the Examiner concludes that inclusion of a summer is either obvious (single reference § 103), or disclosed by Grundy (two reference § 103).

III. RESPONSE TO THE ADOPTED SUBSTANTIVE CLAIM REJECTIONS

A. Independent Claims 19 and 20 Are Not Anticipated by Hellman

The Second Action rejected claims 19 and 20 under 35 U.S.C. § 102(b) as being anticipated by Hellman. (Second Action, pp. 8-9.) Uniloc respectfully traverses.

The key claim term is “licensee unique ID generating means.” There is no dispute that the term invokes the statutory provisions of 35 U.S.C. § 112(6). Section 112(6) terms are statutorily limited in scope and are construed by the PTO in the same way as the courts. *In re Donaldson*, 16 F.3d 1189, 1193 (Fed. Cir. 1994) (“[W]e hold that paragraph six applies regardless of the context in which the interpretation of means-plus-function language arises, i.e., whether as part of a patentability determination in the PTO or as a part of a validity or infringement determination in a court.”) (en banc). This is not to say that the Office does not use the “broadest reasonable interpretation” for construing § 112(6) terms; only that “the ‘broadest reasonable interpretation’ that an examiner may give means-plus-function language is that statutorily mandated in paragraph six.” *Id.* at 1194-95. As such, the Office must turn to Federal Circuit precedent that explains how § 112(6) terms are to be properly construed.

Anticipation under § 112(6) requires identity of function and the same or equivalent structure. *Pennwalt Corp. v. Durand-Wayland, Inc.*, 833 F.2d 931, 934, (Fed.Cir.1987) (en banc). In *Pennwalt*, the Court stated that “to determine whether a claim limitation is met literally, where expressed as a means for performing a stated function, the court must compare the accused structure with the disclosed structure, and must find equivalent structure as well as *identity of claimed function for that structure*.” *Id.* (emphasis added). The function in this case is clear—generating a “licensee unique ID.” The Office must turn to the

'216 patent to construe the term "licensee unique ID" before it can determine whether the cited art *identically* discloses the claimed function.

The claim language itself is the best guidance for proper claim interpretation. *Phillips v. AWH Corp.*, 415 F.3d 1303, 1316 (Fed. Cir. 2005) ("The construction that stays true to the claim language and most naturally aligns with the patent's description of the invention will be, in the end, the correct construction"). The claim term on its face suggests that the ID be generated with some input that is unique to an intended licensee. The term "ID" is modified by the terms "licensee" and "unique." If those terms are to have any meaning in the § 112(6) context, they must carry some weight in the function ascribed to the generating means. That is, there must be some input to the generating means capable of making the resulting "licensee unique ID" uniquely associated with an intended licensee.

The specification is also clear in this regard—the "licensee unique ID" must be generated from some information that is unique to the intended licensee. (*See*, '216 patent, 2:65 - 3:2.) Every example in the specification of the '216 patent is consistent with that requirement. The "licensee unique ID" cannot be based on information that is solely representative of a base unit. (*Id.* at 1:66 - 2:7.) Indeed, such an interpretation is explicitly disclaimed in the Background of the '216 patent specification. ('216 patent, 1:60-65 and 2:4-7.) To generate a licensee unique ID, there must therefore be some input into the generating means that is uniquely associated with the intended licensee. Absent such input, the ID could not be uniquely associated with an intended licensee.

The Office has attempted to equate Hellman's cryptographic function generators 23 and 38 with the claimed "licensee unique ID generating means." (Second Action, p. 9.) But Hellman's cryptographic function generator receives no input that is uniquely associated with

the intended licensee. (Rosenblatt, ¶¶ 38-39.) Hellman's authorization A and check value C are limited to identification of the base unit or the platform on which the software is to be run. (Hellman, 12:5-8.) As noted above, such an ID was disclaimed in the Background of the '216 patent specification. Hellman's cryptographic function generators 23 and 38 therefore cannot perform the identical function as the claimed "licensee unique ID generating means" in the '216 patent.

That "BILLING INFORMATION" in Hellman is NOT associated with Hellman's authorization A or check value C is made explicitly clear by the Hellman reference itself. First, the billing information is not used to generate the authorization and check values (A and C, respectively) in Hellman. Inputs to cryptographic function generator 38 are limited to K (the cipher key), N (the number of desired software uses), R (a random number), and H (signal representing the software to be licensed).

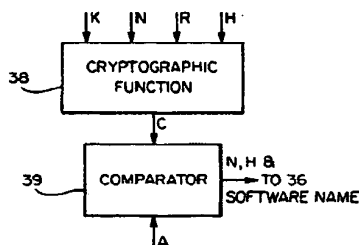

FIG_7

There is no input into Hellman's cryptographic function that is uniquely associated with an intended licensee. (Rosenblatt, ¶¶ 38-39.) This is indisputable and has been affirmed by the Federal Circuit.

Second, Hellman teaches that “authentication of the source of requests [*i.e.*, the intended licensee] is not required. However, it may be necessary to protect against one individual requesting software uses to be billed to another individual’s account. Note that *the authorization would be of no use to the first individual since authorizations are base unit specific.*” (Hellman, 12:5-8; emphasis added.) In other words, Hellman teaches that base-unit-specific licensing of software is, in and of itself, sufficient to discourage unauthorized use obtained through fraudulent billing.

Hellman then proposes a solution to the fraudulent billing problem that STILL does not rely on any information unique to the user (such as billing information) in generating a unique ID. (Hellman, 12:10-26.) Any billing information in Hellman is thus used solely for payment, not for creating authorization A.

Third, Hellman’s own testimony during the district court litigation also confirms Uniloc’s position. (Exhibit A, A2723-45.)

[Attorney] Question: If you wanted to indicate that information associated with the user, unique information was input into the cryptographic function, you certainly had the ability to disclose that in the figures, if you so chose.

[Hellman] Answer: Correct.

[Attorney] Question: And you didn’t?

[Hellman] Answer: Correct.

[Attorney] Question: And you also had the ability to describe in the patent, if you so chose?

[Hellman] Answer: In the specification? Yes.

[Attorney] Question: And you didn’t?

[Hellman] Answer: Correct

(*Id.* at A2743.)

Hellman fails to teach a licensee unique ID generating means. For at least these reasons, Hellman does not anticipate independent claims 19 and 20. The Federal Circuit’s decision affirming the District Court judgment on validity over Hellman is consistent with

Uniloc's position. The pending anticipation rejection of claims 19 and 20 should thus be reconsidered and withdrawn, consistent with the 2011 Federal Circuit decision.

B. Claims 1, 7-11, 19 and 20 Are Not Obvious Over Hellman Alone

In the Second Action, claims 1, 7-11, 19 and 20 stand rejected under 35 USC § 103(a) as being obvious over Hellman. (Second Action, p. 11.) Uniloc respectfully traverses.

This single-reference obviousness rejection relies, in part, on the same erroneous reasoning used to support the anticipation rejection. Specifically, the rejection of each claim asserts that Hellman teaches the claimed "licensee unique ID generating means" because in Hellman "local generation of C ... is associated with a request that includes information provided by and specific to a user, such as billing information." (Second Action, p. 11.) Uniloc deals with this repeated rejection in the preceding section.

The rejection then expresses uncertainty as to whether the structure associated with the licensee unique ID generating means requires a summer as described in the '216 patent. (Second Action, pp. 12-13.) To resolve this question, the Examiner addresses only the case in which the summer is required, and completes the rejection by stating that it would have been obvious to use a summer. (Second Action, p. 13; "Therefore, it would have been obvious to modify the invention of Hellman by using an algorithm ... having summation that could be computed more rapidly.") But whether the structure associated with the claimed "licensee unique ID generating means" requires a summer is irrelevant to the question of functional identity. That is, the presence or absence of a summer in Hellman has no impact on whether Hellman discloses any functionally identical means for generating the claimed "licensee unique ID."

Uniloc therefore reasserts the arguments presented above in response to the rejection under § 102. Hellman does not disclose the claimed licensee unique ID generating means, therefore none of claims 1, 7-11, 19 and 20 are obvious over Hellman for its failure to teach all the limitations of any claim.

C. Claims 1-20 Are Not Obvious Over Hellman In View of Grundy

The Second Action rejected claims 1-20 under 35 U.S.C. § 103(a) as being obvious over Hellman in view of Grundy. (*Id.* at p. 14.) Uniloc respectfully traverses. The Office must clearly articulate the reason(s) why the claimed invention would have been obvious. “[R]ejections on obviousness cannot be sustained with mere conclusory statements; instead, there must be some articulated reasoning with some rational underpinning to support the legal conclusion of obviousness.” *KSR Int’l v. Teleflex Inc.*, 550 U.S. 398, 418 (2007) (*citing In re Kahn*, 441 F.3d 977, 988 (Fed. Cir. 2006)). The rational underpinning in support of the Office’s proposed combination of Hellman and Grundy is sparse and, insofar as it may be understood, it is technically flawed. No one of ordinary skill in the art at the time of the invention would have made the Office’s proposed modifications to Hellman’s cryptographic function generator in view of the checksum algorithms described in Grundy. Nor has the Examiner provided any motivation to do so.

1. Basis for the proposed combination

In support of the § 103 rejection over Hellman in view of Grundy, the Second Action departs from the § 102 rejections over Hellman by alleging that “[o]ver and above the discussion above [referring to the rejections over Hellman alone], it is unclear whether or not the scope of the terms ‘licensee unique ID generating means’ and ‘remote licensee unique ID generating means’ encompasses implementations that do not include a summer in the

algorithm, as per the only embodiment of the '216 patent.” (Second Action, p. 14.) The rejection proposes to modify Hellman by replacing the cryptographic functions used in its cryptographic function generators with the checksum algorithms taught by Grundy.

According to the Examiner, if the claim scope requires a summer, then “it is noted that Hellman stresses that the use of alternative algorithms might be advantageous, particularly an algorithm that could be computed more rapidly....” (Second Action, p. 14; *citing* Hellman, 7:67 – 8:12.) The Examiner erroneously states that Grundy discloses such an alternative algorithm. Specifically, the Examiner alleges that “Grundy discloses an analogous algorithm for unique ID generation, wherein the unique ID, a registration code, is produced by performing a checksum of the user data component fields....” (*Id.*, *citing* Grundy, 15:3-23 and 18:25-29.) The Examiner then concludes that “[t]herefore, it would have been obvious to modify the invention of Hellman by using an algorithm ... having summation, as taught by Grundy, that could be computed more rapidly.” (Second Action, p. 14.)

In summary, the § 103 rejection proposes to replace Hellman’s cryptographic function generator 38 with Grundy’s checksum algorithm so that the alleged licensee unique ID generating means includes the allegedly missing summer. The proposed combination, is illustrated below:²

² An explanation of Uniloc’s understanding of the proposed combination was set forth during the in-person interview conducted on March 3, 2011. (*See* Presentation, p. 14.) The Examiners did not challenge Uniloc’s interpretation of the proposed modification in the Second Action, and it is presumed to have been understood correctly.

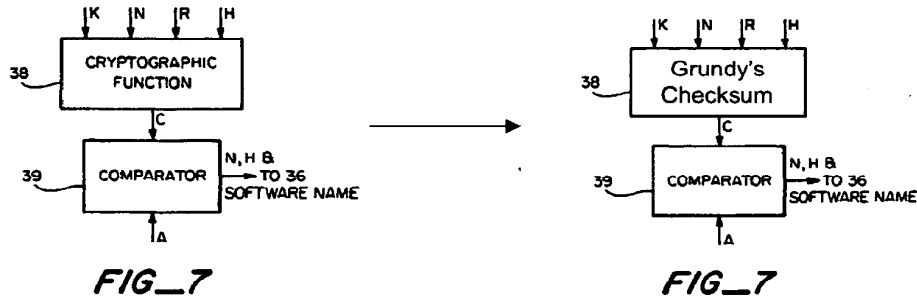

There are, however, multiple problems with this hypothetical combination that render it legally unsustainable as the basis for an obviousness rejection of any claim. **First**, the Examiner mischaracterized Hellman in supporting the purported motivation to combine. **Second**, the Examiner mischaracterized Grundy's use of checksums. **Third**, even if the motivation to modify Hellman's cryptographic function generator were present (which it is not), no one skilled in the art would have made the modification because Grundy's checksum algorithms are not in the same class of cryptographic function that Hellman unambiguously states are *required* for his invention (Hellman, 2:61-65). **Finally**, the proposed combination still fails to address the main deficiency of Hellman noted above because there is STILL no input to the ID generating means that is uniquely associated with an intended licensee, and thus no "licensee unique ID." Each of these deficiencies is fully described below.

2. The Examiner mischaracterized Hellman in supporting the purported motivation to combine.

In support of a motivation to make the proposed modification to Hellman in view of Grundy, the Examiner mischaracterizes Hellman. Specifically, the Examiner alleges that "Hellman stresses that the use of alternative algorithms might be advantageous, particularly an algorithm that could be computed more rapidly." (Second Action, p. 14; *citing* Hellman, 7:67 – 8:12.) But when the full context of Hellman is taken into account, as it must be, it is

clear that Hellman was referring only to its “one way hash function 22,” and not to its “cryptographic function generator 38.” (Pooch Dec., ¶¶ 41-45.)

For example, Hellman states that “[i]n order to make the one-way hash function generator 22 in this manner, one needs a cryptographic system with a much larger key, typically 10,000 to 1,000,000 bits, than ciphertext, typically 100 bits in this invention. The Data Encryption Standard (DES), described in Federal Information Processing Standard 46, is typical of a conventional cryptographic system.” (Hellman, 7:31-37.) With respect to the one way hash function generator 22, Hellman states that “[w]hile DES is used here for illustrative purposes, many other methods and apparatus for generating a one-way hash function are known to exist. DES encryption is very slow on a general purpose signal processor such as a microprocessor.” (Hellman, 7:63 – 8:3.) Hellman goes on to suggest that the DES in the hash function generator 22 could be replaced with something faster. (Hellman, 8:3-12.)

It is clear that the portion of Hellman on which the Examiner relies does not suggest that cryptographic function generators 38 (or 23) be replaced with an algorithm that could be computed more rapidly. Rather, that portion of Hellman suggests a modification to the one way hash function 22 to compute input H more rapidly. (Pooch Dec., ¶ 45.) There is simply no suggestion in Hellman to modify its cryptographic function generator 23 (or 38) in the manner suggested by the Examiner. The Examiner has taken snippets of Hellman out of context in an attempt to cobble together a motivation to substitute Hellman’s cryptographic function generator with Grundy’s checksum algorithm. Uniloc has demonstrated the technical error in that rationale.

3. Examiner mischaracterized Grundy's use of checksums.

The Examiner also mischaracterized Grundy's use of checksums in support of the proposed modification to Hellman's cryptographic function generator. Specifically, the Examiner alleged that:

Grundy discloses an analogous algorithm for unique ID generation, wherein the unique ID, a registration code, is produced by performing a checksum of the user data component fields.

(Second Action, p. 14; *citing* Grundy, 15:3-23 and 18:25-29.)

The Examiner's premise is technically incorrect. As confirmed by Uniloc's expert Dr. Pooch, Grundy's registration code is not produced as a result of a checksum operation. (Grundy, 18:10 – 19:18; Pooch Dec., ¶¶ 25-31.) Specifically, Grundy teaches that the registration code consists of a packed bit array "with each field of the record occupying no more bits than is necessary to encode the information content of the field." (Grundy, 18:61-64; Pooch Dec., ¶ 27.)

There are six fields concatenated to form the registration code bit array. The first four are (i) a user data checksum, (ii) a hardware ID code, (iii) an anti-virus checksum, and (iv) a previous owner's ID number. (Grundy, 18:58-61.) After these four fields are packed into the bit array, the array is encrypted, then (v) a Product/Version ID code is added, then (vi) a data entry checksum is generated for the entire array and added to the array. (Grundy, 19:3-12.) Finally, the packed bit array is converted to an alpha-numeric form suitable for oral or written communication to produce the registration code. (Grundy, 19:13-18.) (*See generally* Pooch Dec. ¶¶25-29.)

The block diagram in Figure A below, as confirmed by Dr. Pooch (Pooch Dec., Figure A), illustrates Grundy's packed bit array:

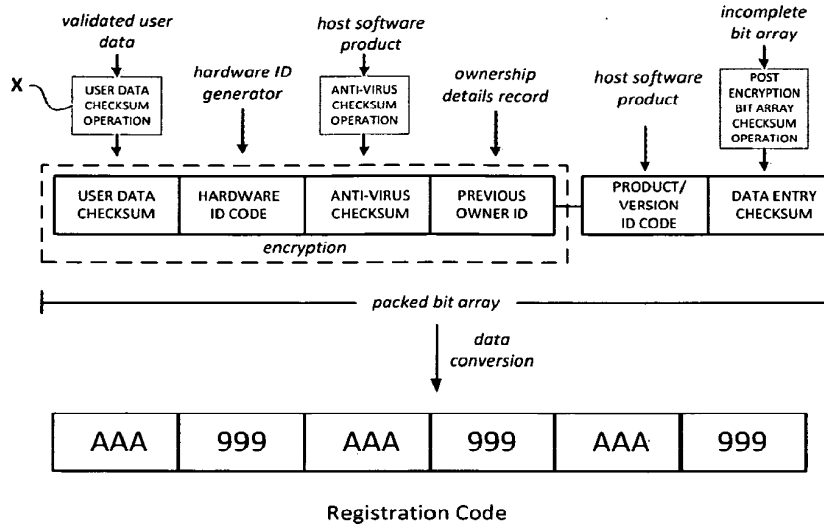

Figure A: Block diagram of Grundy's concatenated registration code

As illustrated in the block labeled "X," the operation that comprises the checksum of the user data component fields is a preliminary step for generating only the data that will later occupy the USER DATA CHECKSUM field of the packed bit array. (Pooch Dec., ¶ 30.) Thus, the premise relied upon in the Second Action that Grundy produces a registration code by "performing a checksum of the user data component fields" is not correct technically. (Pooch Dec., ¶¶ 25-31.) The Examiner has taken snippets of Grundy out of context in an attempt to justify the proposed modification to Hellman's cryptographic function generator.

4. The proposed combination would fundamentally change the operation of Hellman in a way Hellman expressly forbids.

Uniloc has demonstrated in the previous two sections the technical errors in each of the Examiner's factual premises upon which the proposed modifications to Hellman are based. Notwithstanding those deficiencies, one of ordinary skill in the art still would not make the proposed substitution of Hellman's cryptographic functions used in its function generators 38 and 23 with the checksum algorithms described in Grundy. Such a

modification is legally impermissible because it would fundamentally change the operation of Hellman in a way that Hellman itself expressly forbids. *See* MPEP 2143.01(V).

To combat software piracy, Hellman's system is used to authorize a base unit to use a software program a limited number of times. (Hellman, Abstract.) The system allows the manufacturer to control the number of authorized software uses. (*Id.*) To that end, authorizations are made to be base unit specific "so that an authorization for one base unit cannot be transferred to another base unit." (*Id.*) The authorization unit uses a cryptographic function generator 23 to generate an authorization A. An identical cryptographic function generator 38 at the base unit's cryptographic check unit 34 is used to generate a check value C that must match the authorization A at comparator 39. (Hellman 10:14-19.) "If even one bit of C differs from the corresponding bit of A, then A is not considered to be a proper authorization." (Hellman, 10:24-26.) (Pooch Dec., ¶¶ 13-15.)

An essential and critical part of Hellman's system, therefore, is the cryptographic function generators 23 and 38. Hellman's cryptographic function generators are designed to be highly secure and to prevent would-be copiers from generating their own authorizations. (Hellman, 7:4-16.) Hellman describes three conventional cryptographic functions that are "*required to carry out the present invention.*" (Hellman, 2:61-65; emphasis added.) (Pooch Dec., ¶ 16.)

The embodiment described in FIG. 4 uses a modified Data Encryption Standard ("DES"). (Hellman, 8:23-26.) According to Hellman, "[t]he DES would have to be modified ... to have its key length equal to the length of SK" so that it would work in the cryptographic function generator. (Hellman, 8:24-26.) Hellman teaches that this embodiment "would also inherently have the property that the new authorizations could not be predicted from old

authorizations because, in a conventional cryptographic system, given past plaintext-ciphertext pairs, it must have been difficult to determine the plaintext which goes with a new ciphertext.” (Hellman, 8:46-51.) This embodiment thus uses a robust and highly secure algorithm to generate an authorization code sufficiently secure to meet the rigorous needs of Hellman’s system. (Pooch Dec., ¶ 17.)

In an alternate embodiment described in FIG. 9, “[s]ignals representing H, R and N are presented as a message to be signed by a public key cryptosystem 43 using secret key SK to produce the digital signature,” which becomes authorization A. (Hellman, 1:42-47.) Like the DES embodiment, a public key cryptosystem is a highly secure, robust algorithm that meets the rigorous needs of Hellman’s system. (Pooch Dec., ¶ 17-21.) Finally, in yet another described embodiment, Hellman discloses that “[o]ne implementation of the cryptographic function generator 23 of FIG. 2 would also involve a one-way hash function....” (Hellman, 8:13-15.) Again, a one-way hash function is a robust, highly secure algorithm that meets the rigorous needs of Hellman’s system. (Pooch Dec., ¶¶ 22-23.)

Each of alternative embodiments that Hellman describes to implement its cryptographic function generators 38 and 23—DES, public key encryption or one-way hash function—are sophisticated, cryptographically robust algorithms that meet the rigorous needs of Hellman’s system. As noted, Hellman states that such conventional cryptographic functions are “*required to carry out the present invention.*” (Hellman, 2:61-65; emphasis added.) (Pooch Dec. ¶ 24.)

In the Examiner’s proposed combination, cryptographic functions described as required to implement Hellman’s cryptographic function generators 23 and 38 would be replaced with checksum algorithms described in Grundy. No one of skill in the art would

make such a substitution. The simple checksums described in Grundy are an entirely different class of algorithm and cannot provide the security required by Hellman. (Pooch Dec. ¶¶ 32-39.) As Dr. Pooch explains that “Grundy ... describes several conventional uses for checksums.” (Pooch Dec. ¶ 8.) For example, “the checksums described in Grundy are not cryptographic functions, but rather appear to be used to check, for example, for typographical data entry errors or transmission errors.” (Pooch Dec., ¶ 32.)

As Dr. Pooch concludes, “Grundy’s checksums are quite distinct from cryptographic functions, which are used for different applications. If Grundy’s checksums were to be used for security applications, for example, they would be vulnerable to attack. For example, a checksum’s linearity may be exploited by a malicious adversary.” (Pooch Dec., ¶ 39.) Grundy’s simple error checking or data verification checksum algorithms are simply not analogous to the three cryptographic functions described by Hellman that, in Hellman’s words, are “*required to carry out the present invention*” (Hellman, 2:61-65). (Pooch Dec. 32-39.)

5. Even with proposed modification, Hellman still does not generate a licensee unique ID.

Even if the proposed modification to Hellman were proper (which it is not), it still fails to address the main deficiency of Hellman noted above—there is STILL no input to the ID generating means that is uniquely associated with an intended licensee.

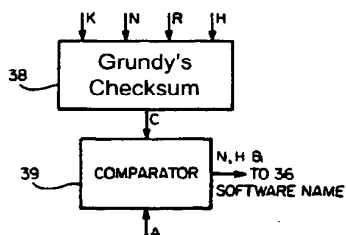

FIG_7

Hellman therefore cannot generate a “licensee unique ID.” Uniloc’s position in this regard is set forth above in **Section III.A**. Uniloc’s position in this regard has been affirmed by the Federal Circuit and admitted by Hellman himself at trial.

D. Dependent Claims 2, 12 and 17 Are Also Not Obvious Over Hellman In View of Grundy

The Examiner makes additional arguments with respect to Hellman and Grundy in rejecting dependent claims 2, 12 and 17. But in attempting to cobble together a motivation for additional modifications to Hellman, the Examiner has mischaracterized Grundy. Specifically, the Examiner makes the same technical errors noted above when characterizing Grundy’s use of checksums.

1. The Examiner mischaracterized Grundy in supporting the proposed motivation to combine.

In the obviousness rejections of claims 2, 12 and 17 based on Hellman in view of Grundy, the Second Action proposes to satisfy the first prong of the obviousness test, whether the references provide a suggestion or motivation to combine reference teachings in the manner claimed, by citing to a transitional paragraph in Grundy at 4:9-18. The paragraph is reproduced here:

As a result, there is a significant and substantial need in the information industry to allow developers to sell their information product to the full potential market efficiently, that encourages and takes advantage of consumer participation in the manufacture and distribution of the information products yet has centralized monitoring and control, that permits consumers to evaluate the product prior to the purchase decision, that effectively combats piracy, and that permits developer profit for funding of support and update services.

The Second Action interprets this paragraph as providing a definitive suggestion “to modify the invention of Hellman by incorporating uniquely descriptive user data into the licensee ID.” (*See e.g.*, Second Action, p. 15.)

Uniloc respectfully submits that this interpretation is a textbook example of hindsight reasoning. There is no suggestion or reference whatsoever to the use of uniquely descriptive user data in that paragraph. At best, the paragraph merely suggests that software developers should harness the distribution power of casual copying. It is nothing more than a typical paragraph in a patent application that paraphrases the problems in the prior art as discussed in the Background section. Moreover, it is casual copying that the '216 patent sought to *prevent*. To suggest that one skilled in the art seeking to improve upon Hellman to address the problem of casual copying would read that paragraph in Grundy, which advocates casual copying, as motivation to combine the references is nonsensical. There is simply no motivation to combine the references as suggested by the Examiner in the Second Action. While not dispositive, it cuts against the proposed combination.

2. The Examiner has again mischaracterized Grundy's use of checksums.

In the obviousness rejections of claims 2, 12 and 17 over Hellman in view of Grundy, the Second Action observes that Hellman implements a hash function in cryptographic function generator 38 to generate licensee unique ID. (Second Action, p. 15.) The Examiner also observes that the hash function "produces a number that is so unlikely to be reproduced independently that it is at least as unique [as] the IDs from the disclosure of the '216 patent". (Second Action, p. 15; *citing* Hellman, 6:31-52.)

Hellman describes a uniqueness property of the one-way hash function generator 22 as follows: "given an H [output] value it is difficult, taking perhaps millions of years, to compute any other software package which produces this same H value As with any hash function, the one-way hash function generator 22 has a much shorter output, perhaps 100 bits, than its input, typically 10,000 to 1,000,000 bits in this invention." (Hellman, 6:31-52.)

This is consistent with Hellman's teaching that "for purposes of this invention, we are primarily concerned with one-way compressive functions, where [input] X is much longer than [output] Y. Typical values herein will be a 100,000 bit length for X and a 100 bit length for Y. A method for generating such an extremely compressive one-way function is described in the patent." (Hellman, 3:47-53.) Hellman teaches that cryptographic function generator 38 may also use this type of one-way hash function. See Hellman at 8:13-15 and 10:27-29. Thus, the Second Action establishes the "uniqueness" feature of Hellman in view of Grundy based on the functionality of Hellman's one-way hash function operating as the cryptographic function generator 38.

In the rejection of claim 1 on page 14, on the other hand, the Examiner proposes to replace Hellman's cryptographic function generator 38 with the checksum of Grundy to provide the summation algorithm limitation absent from the teachings of Hellman. (Second Action, p. 15; bottom.) However, if these references are combined as the Examiner suggests, with Grundy's error-checking checksum replacing Hellman's cryptographic function generator, the Examiner can no longer take credit for the "uniqueness" feature provided by Hellman because the source of that uniqueness, the one-way compressive hash function having a 100:1 X/Y bit ratio, would also be replaced by Grundy's checksum. Uniloc therefore requests that the obviousness rejection of claims 2, 12 and 17 be reconsidered and withdrawn.

IV. OBJECTIVE INDICIA OF NON-OBVIOUSNESS

Uniloc set forth above the legal and technical errors in the currently pending rejections in the Second Action. Based on those errors alone, the Office should reconsider and withdraw the pending rejections. There is also additional, independent, compelling

evidence of non-obviousness in the form of the so-called “secondary considerations.” Such objective indicia of non-obviousness include, for example, (i) commercial success, (ii) long felt need, and (iii) unsuccessful attempts of others to solve the problem. *See, Graham v. John Deere Co.*, 383 U.S. 1 (1966).

The so-called secondary indicia acknowledged by the courts and by the Office are “essential components of the obviousness determination.” *In re Rouffet*, 149 F.3d 1350, 1355 (Fed. Cir. 1998.) Secondary indicia “may be highly probative, as they are ‘tributes to ingenuity.’” *Arkie Lures, Inc. v. Gene Larew Tackle, Inc.*, 119 F.3d 953, 957 (Fed. Cir. 1997). Indeed, secondary indicia of non-obviousness are not just a cumulative or confirmatory part of the obviousness calculus, but constitute independent evidence of non-obviousness. *Ortho-McNeill Pharm., Inc. v. Mylan Labs., Inc.*, 520 F.3d 1358, 1365 (Fed. Cir. 2008.)

Courts are obligated to consider objective evidence of non-obviousness when such evidence is present. *Knoll Pharm. Co. v. Teva Pharms, USA, Inc.*, 367 F.3d 1381, 1385 (Fed. Cir. 2004); *Custom Accessories, Inc. v. Jeffrey-Allan Indus., Inc.*, 807 F.2d 955, 960-61 (Fed. Cir. 1986.) Consistent with that requirement, the Office is also required to consider secondary considerations of non-obviousness, where present. MPEP § 2145 (“Office personnel should consider all rebuttal arguments and evidence presented by applicants.”) Such rebuttal evidence includes, of course, evidence relating to the secondary considerations as set forth in *Graham v. John Deere Co. Id.* Finally, “to be entitled to substantial weight, the applicant should establish a nexus between the rebuttal evidence and the claimed invention, *i.e.*, objective evidence of nonobviousness must be attributable to the claimed invention.” *Id.*

Evidence in support of commercial success, long-felt need and failure by others was fully developed, authenticated and presented as sworn testimony during the concurrent district court litigation in this case. Moreover, much of it was consolidated in a Joint Appendix submitted by the parties to the Federal Circuit as part of the appeal briefing. Relevant evidence from the district court litigation and portions of the Joint Appendix are attached hereto as Exhibit A.

A. Uniloc Has Conclusively Established the Commercial Success of At Least Independent Claim 19

Uniloc has conclusively established the commercial success of at least independent claim 19. Over the course of the parallel litigation in the Federal district courts, Microsoft's Product Activation technology was found to infringe independent claim 19 of the '216 patent. *Uniloc USA et al. v. Microsoft Corp.*, --- F.3d ---, 2011 WL 9738 (Fed. Cir. 2011). This infringement conclusively establishes a nexus between the claimed invention and the accused product. Uniloc has also conclusively established the commercial success enjoyed by Microsoft's Product Activation. The result is independent evidence in support of the non-obviousness of claim 19.

1. Uniloc has conclusively established a nexus between independent claim 19 and Microsoft's Product Activation technology

A nexus is required between the secondary considerations and the claimed invention. *Simmons Fastener Corp. v. Ill. Tool Works, Inc.*, 739 F.2d 1573, 1575 (Fed. Cir. 1984.) The term "nexus" designates a factually and legally sufficient connection between the evidence of commercial success and the claimed invention so that the evidence is of probative value in the determination of nonobviousness. *Demaco Corp. v. F. Von Langsdorff Licensing Ltd.*, 851 F.2d 1387 (Fed. Cir. 1988).

Atty. Dkt. No. 2914.001REX0

UNI075223

A nexus has been indisputably established in this case by the Courts in the concurrent litigation. On January 4, 2011, the Court of Appeals for the Federal Circuit affirmed the original jury verdict that Microsoft's Product Activation technology infringes claim 19 of the '216 patent. *Uniloc USA et al. v. Microsoft*, --- F.3d ---, 2011 WL 9738 (Fed. Cir, 2011).

2. Uniloc has conclusively established the commercial success of Microsoft's Product Activation technology

The commercial success of an invention is evidence of its non-obviousness. *Goodyear Tire & Rubber Co. v. Ray-O-Vac Co.*, 321 U.S. 275, 279 (1944); *Al-Site Corp. v. VSI Int'l, Inc.*, 174 F.3d 1308, 1325-26 (Fed. Cir. 1999.) And activity by a competitor can qualify as commercial success. *Gambro Lundia AB v. Baxter Healthcare Corp.*, 110 F.3d 1573, 1579 (Fed. Cir. 1997). For example, in *Gambro Lundia*, the Federal Circuit found "significant evidence of the commercial success of [the] invention" based on the infringer's sales of the infringing product. *Id.*

At trial, the Court heard testimony that approximately \$5.5 billion of *additional revenue*, on total software sales revenue of \$19.27 billion, was attributable to Microsoft's Product Activation (*See*, Exhibit A, A2259-260, A3297-298). As noted above, Microsoft's Product Activation technology infringes at least claim 19 of the '216 patent. Such additional revenue by Microsoft is remarkable evidence of commercial success. Additionally, Microsoft's internal documents state that a pilot program of Product Activation in China resulted in increased revenues of 140% with an overall increase in all pilot countries of 73%. (*See*, Exhibit A, A2236) Further, Microsoft states that the use of Product Activation positively impacts over 70% of Microsoft's total revenue. (*See*, Exhibit A, A2238.) Again, such increases in revenue directly attributable to the product found to infringe the claimed

invention are clear indicators of the commercial success of the invention of claim 19 infringed by Microsoft.

3. Summary for Commercial Success

Microsoft's Product Activation technology has been found to infringe at least claim 19 of the '216 patent. Microsoft's Product Activation is directly responsible for billions of dollars of additional revenue garnered by Microsoft as a result of Product Activation. Uniloc has thus conclusively established the objective indicia of commercial success for at least independent claim 19 of the '216 patent. This is strong evidence that claim 19 is not obvious over Hellman in view of Grundy.

B. The '216 Patented Technology Met a Long-Felt Need

Long-felt need is another objective indicia of non-obviousness. *Northern Telecom Inc. v. Datapoint Corp.*, 908 F.2d 931, 935 (Fed. Cir. 1990). "Where the invention for which a patent is sought solves a problem which persisted in the art, we must look to the problem as well as to its solution if we are to properly appraise what was done and to evaluate it against what would be obvious to one having the ordinary skills of the art." *In re Rothermel*, 276 F.2d 393, 397 (CCPA 1960). Where a problem exists over an extended period of time with known defects, and an invention curing those defects is marked by commercial success, "these factors are entitled weight in determining whether the improvement amounted to invention and should, in a close case, tip the scales in favor of patentability." *Goodyear Tire & Rubber Co. v. Ray-O-Vac Co.*, 321 U.S. 275 (1944). Long-felt need is thus viewed through the lens of the problems existing in the art. And where the claimed invention successfully meets the long-felt need, this objective indicia is met. That is the case here.

Prior to the introduction of the '216 software activation solution to the software market, unauthorized copying of software, or "software piracy," was a significant billion dollar problem. For example, in letter from Bill Gates in 1976, Mr. Gates expressed his concern that a majority of the hobbyist audience stole the software that they used. (Exhibit B.)

With the advent of the Internet, the problem of casual copying reached crisis proportions for software publishers. In 1996, for example, research by the Business Software Alliance ("BSA") found that about \$15 billion in software was stolen each year where the "U.S., Japan, and Germany account for 43 percent of the global loss total, with more than \$1.8 billion in losses." (Exhibit C.) Thus, twenty years after the problem was recognized by Bill Gates, software piracy persisted, unabated.

The long-felt need in the industry is confirmed by Uniloc's expert William Rosenblatt. Mr. Rosenblatt was directly involved in the area of digital rights management at the relevant times here. (Rosenblatt Supp. Dec. ¶¶ 7, 10 and 11.) He was personally aware, at that time, of a long felt need in the software industry to combat piracy and that the software industry as a whole was losing a substantial portion of potential revenue due to casual copying. (Id.) Mr. Rosenblatt stated that "[t]his need had been felt since the beginning of the personal computing industry (the IBM PC was first released in 1981). But it intensified in the early 1990s, as the advent of networked digital technologies made it possible to copy software and other forms of digital intellectual property on a massive scale and at virtually no cost." (Id.) According to Mr. Rosenblatt, "[t]he industry's concern about this problem coalesced in 1993 around a conference held in Washington, DC called "Technological Strategies for Protecting Intellectual Property in the Networked Multimedia Environment."

(Rosenblatt Supp. Dec. ¶11.) The '216 patent was filed in late 1992 and issued in February 1996.

Microsoft internal documents, submitted at trial, are also consistent with the long-felt industry need. Prior to the development of Product Activation, Microsoft recognized that it was losing billions of dollars to casual copying. (Exhibit A, A2425.) In another Microsoft trial document, Microsoft estimated the pirate market for software application was greater than \$7 billion/year with approximately 50% of losses due to casual copying. (See, Exhibit A, A2226-7.) As shown above, Microsoft was able to recoup a large portion of revenues (\$5.6 billion) it had been previously losing due to the success of its Product Activation technology.

Uniloc has thus established that prior to the September 1993 filing date of the '216 patent, the software industry faced a long-felt need to prevent piracy due to casual copying, the problem addressed by the '216 patent. ('216 patent, 1:5-9.)

The invention at claim 19 in the '216 patent is directed to a solution for the long-felt need of casual copying. And the claimed invention has been established as a successful solution to that long-felt need. Long-felt need is therefore another objective indicia that claim 19 is not obvious.

C. Failure by Others.

Prior failures by other inventors has been called “virtually irrefutable” evidence of non-obviousness. *Panduit Corp. v. Dennison Mfg. Co.*, 774 F.2d 1082, 1099 (Fed. Cir. 1985) *vacated on other grounds*, 475 U.S. 809 (1986). Similarly, earlier efforts that were “going in different ways” is also “strong evidence” of non-obviousness. *Id.* Prior failures are not viewed uncritically, however. Evidence of prior failure is not persuasive if the person who

failed was not motivated to succeed due to satisfaction with the status quo. *In re Sneed*, 710 F.2d 1544 (Fed. Cir. 1983). But that is not the case here. As demonstrated above, software piracy was costing the software industry billions of dollars and the status quo was clearly unsatisfactory. (Rosenblatt, ¶¶ 12-15.)

Prior to development of Product Activation, Microsoft attempted to develop a registration system based on a product identifier (PID). However, the approach would not work with CD based software, being limited to floppy diskette based software. Microsoft then attempted to upgrade the product identifier registration system approach with a forced registration pilot named HDDI with CD, by shipping a floppy disk with a CD-ROM. The HDDI system was proven unsuccessful and went “nowhere because everybody disliked it.” (See e.g., Exhibit A, A2426-27, A3297.)

In addition to Microsoft’s own failures, many others failed as well. (Rosenblatt Supp. Dec. ¶¶ 13-14.)

D. Conclusion with Respect to Objective Indicia of Non-Obviousness

Uniloc has established objective indicia of non-obviousness, including commercial success, long-felt need and failure by others. It has also, in each case, established the required nexus with the claimed invention. For these additional reason, Uniloc respectfully requests that the Office reconsider and withdraw the Section 103 rejection of claims 1-20.

V. STATUS OF CONCURRENT LITIGATION

Uniloc filed its initial suit against Microsoft Corporation in the United States District Court for the District of Rhode Island in September 2003 for infringement of the ‘216 patent. *See Uniloc USA, Inc. et al. v. Microsoft Corp.*, C.A. No. 03-440 (D.R.I. 2003). In October 2007, the Rhode Island District court granted summary judgment of non-infringement in

Microsoft's favor. Uniloc appealed to the United States Court of Appeals for the Federal Circuit. In August 2008, the Federal Circuit reversed and remanded the district court's grant of summary judgment. *See Uniloc USA et al. v. Microsoft Corp.*, 290 Fed. Appx. 337 (Fed. Cir. 2008).

On remand, in April 2009, a jury awarded Uniloc \$388 million in damages based on Microsoft's infringement of the '216 patent. However, in September 2009, the district court granted Microsoft's motion for judgment as a matter of law (JMOL) for non-infringement. Uniloc filed an appeal with the United States Court of Appeals for the Federal Circuit in February 2010. The case was argued on September 7, 2010.

On January 4, 2011, the United States Court of Appeals for the Federal Circuit reversed the district court's grant of JMOL of non-infringement and upheld claim 19 as not being anticipated or obvious over U.S. Patent No. 4,658,093 to Hellman. (See, *Uniloc USA, Inc. et al. v. Microsoft*, --- F.3d ---, 2011 WL 9738 (Fed. Cir, 2011). The Federal Circuit also remanded the case to the district court on the issue of damages.

VI. IMPROPER GRANT OF A SUBSTANTIAL NEW QUESTION OF PATENTABILITY

Uniloc asserts that the substantial new question of patentability ("SNQ") in this case was erroneously granted. In the Order granting reexamination of the '216 patent, the Office stated with respect to its SNQ analysis of Hellman that "[i]t is agreed that a reasonable examiner would have found this reference important, either alone *or in combination with Grundy*, in determining the patentability of claims 1-20." (Order, p. 8-9; emphasis added.)

With respect to its SNQ analysis of Grundy, the Office properly reviewed the prosecution history for the '216 patent and determined that Grundy had already been

considered by the Office. It thus reviewed the premise upon which the Requester urged that Grundy provided an SNQ. The Office concluded that “[i]t is NOT agreed that a reasonable examiner would have found this reference important in determining the patentability of claim 1-20.” (Order, p. 9.) The basis for this determination was that the Requester attempted to rely on Grundy’s checksums; and, according to the Office, Grundy’s “[c]hecksums are not unique fields, even if there [sic] are at least in part derived from unique data.” (Order, p. 9.)

Yet despite this technically correct analysis of Grundy’s checksums, the Office in the First Action relied on Grundy’s checksums to “disclose an analogous algorithm for unique ID generation, wherein the unique ID, a registration code, is produced by performing a checksum of the user data component fields.” (First Action, p. 7.) The Office thus *directly contradicted itself* in the First Action. Uniloc pointed out this inconsistency in its reply to the First Action. (Reply, p. 28.) Nonetheless, the Office maintained this inconsistency in the Second Action, where it *again* relies on Grundy to “disclose an analogous algorithm for unique ID generation, wherein the unique ID, a registration code, is produced by performing a checksum of the user data component fields.” (Second Action, p. 14.)

It is highly anomalous for the Office to correctly state in the Order granting reexam that Grundy does NOT present an SNQ because its checksums are not unique; and then take the opposite position in two subsequent rejections over Hellman in view of Grundy. Uniloc asserts that, contrary to the Office’s assertion in the Order, Hellman in view of Grundy does NOT present a substantial new question of patentability upon which this reexamination should have been based. Moreover, Uniloc maintains that the grant of the SNQ over Hellman in view of Grundy was improper because Grundy was already fully considered during the

original prosecution of the '216 patent. This position is set forth in Uniloc's Reply to the First Action and is incorporated by reference herein. (*See* Reply, p. 16.)

VII. STATEMENT OF THE SUBSTANCE OF THE INTERVIEW

Pursuant to 37 C.F.R. § 1.133(b), Uniloc provides the following summary of the in-person interview held on March 3, 2011. Present at the interview for the Office were Primary Examiner Matthew Heneghan, Examiner Mary Steelman, and Senior Primary Examiner Jessica Harrison. Brad Davis (CEO, current Board member of Uniloc Singapore Private Limited) and Sean D. Burdick (Uniloc Patent Counsel, Reg. No. 51,513) were present on behalf of Uniloc. William Rosenblatt (Technical Expert), Robert G. Sterne (Reexam Counsel, Reg. No. 28,912), Jon E. Wright (Reexam Counsel, Reg. No. 50,720), Robert W. Molitors (Reexam Counsel, Reg. No. 66,726), James L. Etheridge (Uniloc Outside Counsel, Reg. No. 37,614) were also present at the interview on behalf of Uniloc. At the interview, Uniloc presented a PowerPoint© presentation ("Presentation"), a copy of which was provided to the panel for the record. The substance of the interview captured in the Presentation. No agreement was reached on the claims in reexamination.

Conclusion

All of the stated grounds of rejection have been properly traversed. Patent Owner therefore respectfully requests that the Examiner reconsider all presently outstanding rejections and that they be withdrawn. Patent Owner believes that a full and complete reply has been made to the outstanding Second Action and, as such, the present claims are in condition to be confirmed. If the Examiner believes, for any reason, that personal communication will expedite prosecution of this reexamination, the Examiner is invited to telephone the undersigned at the number provided.

Prompt and favorable consideration of this Reply is respectfully requested.

Respectfully submitted,

STERNE, KESSLER, GOLDSTEIN & FOX P.L.L.C.

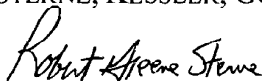

Robert Greene Sterne
Attorney for Patent Owner
Registration No. 28,912



Jon E. Wright
Attorney for Patent Owner
Registration No. 50,720



Robert W. Molitors
Attorney for Patent Owner
Registration No. 66,726

Date: March 18, 2011

1100 New York Avenue, N.W.
Washington, D.C. 20005-3934
(202) 371-2600

Atty. Dkt. No. 2914.001REX0

UNI075232

Patent Under Reexamination: U.S. Patent No. 5,490,216
Reexamination Control No.: 90/010,831
Examiner: HENEGHAN, Matthew
Art Unit: 3992

Commissioner for Patents
P.O. Box 1450
Alexandria, VA 22313-1450
Sir:

**CERTIFICATION OF SERVICE OF PATENT OWNER REPLY TO OFFICE ACTION
IN EX PARTE REEXAMINATION**

In compliance with 37 C.F.R. § 1.550(f), the undersigned, on behalf of the Patent Owner, hereby certifies that copies of these papers identified above will be served on the Third Party Requester by first class mail on March 21, 2011. The name and address of the attorney representing the Third Party Requester served is as follows:

Kyle B. Rinehart
Klarquist Sparkman LLP
One World Trade Center, Suite 1600
121 S.W. Salmon Street
Portland Oregon 97204

Respectfully submitted,

STERNE, KESSLER, GOLDSTEIN & FOX P.L.L.C.

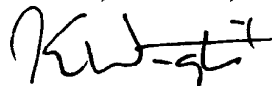

Jon E. Wright
Attorney for Patent Owner
Registration No. 50,720

Date: March 18, 2011

1100 New York Avenue, N.W.
Washington, D.C. 20005-3934
(202) 371-2600

Atty. Dkt. No. 2914.001REX0

UNI075233